

**BOUGIES D'ALLUMAGE ET PRÉCHAUFFAGE
CAPUCHONS ANTIPARASITES**

SONDES LAMBDA



**IGNITION
PARTS**



**VEHICLE
ELECTRONICS**

CATALOGUE 2017 - 2018

BOUGIES
D'ALLUMAGE



BOUGIES
DE PRÉCHAUFFAGE



BOBINES
D'ALLUMAGE



FAISCEAUX
HAUTE TENSION



SONDES
LAMBDA



CAPTEURS
DE TEMPÉRATURE



CAPTEURS
DE PRESSION



DÉBITMÈTRES
D'AIR



QUAND
PERFORMANCE
RIME AVEC
PRÉCISION



IGNITION
PARTS



VEHICLE
ELECTRONICS

SOMMAIRE GÉNÉRAL



INFORMATIONS TECHNIQUES

- 2 Signification des références
- 3 Recommandations de montage
- 4 Cas de remplacement
- 5 Bougies hautes performances
- 6 Bougies Iridium *IX* (Table de correspondances)
- 7 Bougies compétition Racing



CYCLOS / MOTOS

- 12 à 98** Bougies d'allumage
- 99 à 124** Capuchons antiparasites
- 125 à 133** Sondes Lambda
- 134** Stock-type bougies d'allumage Cyclos/Motos



MOTOCULTURE

- 138 à 210** Bougies d'allumage
- 211** Stock-type bougies d'allumage Motoculture
- 213 à 219** Bougies de préchauffage
- 220** Stock-type bougies de préchauffage Motoculture



MARINE

- 224 à 239** Bougies d'allumage Inboard
- 240 à 283** Bougies d'allumage Hors-bord
- 284 à 291** Bougies d'allumage Motonautisme
- 292** Stock-type bougies d'allumage Marine



ÉQUIVALENCES

- 293 à 316** Équivalences bougies d'allumage et préchauffage



SIGNIFICATION DES RÉFÉRENCES

	Ø (mm)	Clé 6 pans (mm)	Pas de vis (mm)
A	18	25,4	1,50
B	14	20,8	1,25
C	10	16,0	1,00
D	12	18,0	1,25
E	8	13,0	1,00
G	1/2 pouce	23,8	1,25
J	12	18,0	1,00
AB	18	20,8	1,50
BC	14	16,0	1,25
BK	14 (BPC aux normes ISO)	16,0	1,25
DC	12	16,0	1,25
Référence BM_A & BPM_A			
14	19,0	1,25	
Référence CM-6			
10	14,0	1,00	

Construction - caractéristiques	
L	Isolant court
M	Type compact
P	Isolant proéminent
R	Résistance intégrée
U	Décharge superficielle ou semi-superficielle
Z	Inductance intégrée

Longueur filetage en (mm)	
E	19,0
H	12,7
L	11,2
EH	Semi-filetage
Culot =	19
Filet =	12,7
Type BM_A, B_LM :	9,5
Type CMR_A :	9,5
F	Siège conique
Type A_F :	10,9
Type B_F :	11,2
Type B_EF :	17,5
Type BM_F :	7,8
Type BPM_F :	7,8
Type A_ :	12,0
Type B_/BM_ :	9,5
Type CM_ :	8,5
Type G_ :	22,5

B C P R 6 E S - 11

Type	Description
D	Haute capacité d'allumage : technologie DFE
I	Bougie Iridium
L	Longueur de filetage 26,5 mm
P	Bougie Platine
S	Haute capacité d'allumage : insert Platine
Z	Isolant surprojeté

Ces lettres peuvent être combinées
Ex : IZ, LZ, PL, PLZ, etc.

Indice thermique	
2	Chaud
4	
5	
6	
7	
8	
85	
9	
95	
10	
105	
11	
12	Froid

Écartement	
Moto :	0,70 - 0,80
Auto :	0,80 - 0,90
8	0,80
9	0,90
10	1,00
11	1,10
13	1,30
14	1,40
15	1,50

Dessin de l'éclateur	
A, B, D, E	Dessin spécial
CM/CS	Électrode de masse oblique
F/FS	Siège conique
G	Électrode fine en alliage de Nickel
GV	Électrode centrale Or-Palladium (compétition)
I	Électrode centrale en Iridium
IX	Gamme Iridium IX
J	2 électrodes de masse
K	2 électrodes de masse à effet semi-superficielle
KC	2 électrodes de masse
-L	Demi indice thermique plus chaud
-LM	Type compact longueur d'isolant 14,5 mm
M	3 électrodes de masse pour moteur rotatif Mazda
-N	Électrode de masse spéciale
P	Électrode centrale en Platine
Q	4 électrodes de masse
S	Électrode centrale en cuivre
SZ	Électrode centrale en cuivre, diamètre 2,9 mm
T	3 électrodes de masse
U	Type à décharge semi-superficielle
V	Électrode centrale Or-Palladium
VX	Électrode centrale en Platine
W	Électrode tungstène
X	Éclateur interne
Y	Gorge en "V"-Proéminence sup. de 1 mm

P F R 6 A - 11 A

Dimension du culot				
Ø (mm)	Longueur (mm)	Joint	Clé 6 pans (mm)	Pas de vis (mm)
F	14,0	19,0	Joint	16,0 1,25
G	14,0	19,0	Joint	20,8 1,25
J	12,0	19,0	Joint	18,0 1,25
K	12,0	19,0	Joint	16,0 1,25
KA	12,0	19,0	Joint	14,0 1,25
KB	12,0	19,0	Joint	Bi-Hex 14,0 1,25
L	10,0	12,7	Joint	16,0 1,25
M	10,0	19,0	Joint	16,0 1,00
MA	10,0	19,0	Joint	14,0 1,00
NA	12,0	17,5	Siège conique	14,0 1,00
T	14,0	17,5	Siège conique	16,0 1,25
Exception PTR5A, TR5A, TR5B				
14,0	25,0	Siège conique	16,0	1,25
U	14,0	11,2	Siège conique	16,0 1,25
W	18,0	10,9	Siège conique	20,8 1,50
X	14,0	9,5	Siège conique	20,8 1,50
Y	14,0	11,2	Siège conique	16,0 1,25

Type de construction	Description
R	Résistance

Familles de conception	
A, B, C...	Caractéristiques spéciales
I	Électrode centrale Iridium
P	Électrode centrale en Platine
...	...

Caractéristiques particulières	
A	Sans joint
B	Design spécial
C	Design spécial
D	Design spécial
...	...



RECOMMANDATIONS DE MONTAGE

ÉCARTEMENT DES ÉLECTRODES



Il est parfois nécessaire de régler l'écartement des électrodes car il ne correspond pas toujours au réglage spécifique à chaque application.

Les écartements sont spécifiés pour chaque application.

Le réglage des électrodes est indispensable pour une combustion optimale !

REPLACEMENT D'UNE BOUGIE

1. Utiliser une clé à bougie adaptée.
2. Attendre que le moteur refroidisse pour démonter la bougie.
3. Tourner légèrement le capuchon du câble d'allumage et l'enlever en tirant sur ce capuchon et non sur le câble.
4. Retirer les capuchons un par un pour ne pas les mélanger.
5. S'assurer que le capuchon et la câble d'allumage ne soient pas endommagés.
6. Desserrer de 1/4 de tour la bougie et nettoyer les saletés avec de l'air comprimé.
7. Démonter la bougie.
8. Nettoyer le siège de la bougie et remonter une bougie neuve en la vissant manuellement sans utiliser de graisse sur les filets.
9. **Visser la bougie avec le couple de serrage préconisé** (tableau ci-contre).
10. Remettre en place le câble d'allumage, en vérifiant le bon accrochage du capuchon.
11. Pour les autres cylindres, renouveler les opérations de 4 à 10.
12. Vérifier l'état du circuit d'allumage.

COUPLE DE SERRAGE



UTILISER UNE CLÉ DYNAMOMÉTRIQUE



	Modèle à siège plat (avec joint)						Modèle à siège conique	
	Ø	18 mm	14 mm	12 mm	10 mm	8 mm	18 mm	14 mm
Culasse Fonte	N.m	35 - 40	25 - 30	15 - 25	10 - 15	-	20 - 30	10 - 25
	m.kg	3,5 - 4,0	2,5 - 3,0	1,5 - 2,5	1,0 - 1,5	-	2,0 - 3,0	1,0 - 2,5
Culasse Aluminium	N.m	35 - 40	25 - 30	15 - 20	10 - 12	8 - 10	20 - 30	10 - 20
	m.kg	3,5 - 4,0	2,5 - 3,0	1,5 - 2,0	1,0 - 1,2	0,8 - 1,0	2,0 - 3,0	1,0 - 2,0

// Ø 18 et 14 mm
1/2 - 2/3 tour
(180° à 240°)



// Ø 12 et 10 mm
1/2 tour
(180°)

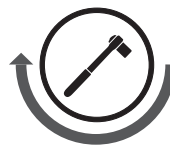

// Ø 8 mm
1/3 tour
(120°)



En cas de serrage angulaire, serrer la bougie comme indiqué ci-dessus









**Une grande partie de la chaleur s'évacue par le plan de joint.
Un serrage trop important ou trop faible nuit à une bonne évacuation thermique et peut entraîner des dommages moteurs.**





CAS DE REMPLACEMENT

SYMPTÔMES	CAUSES POSSIBLES	SOLUTIONS
 <p>Électrodes usées Manque de puissance moteur Ratés d'allumage Consommation accrue</p>	<ul style="list-style-type: none"> ▶ Dépassement de la périodicité de remplacement 	<ul style="list-style-type: none"> ✓ Remplacer la bougie
 <p>Encrassement sec ou humide Mauvais allumage</p>	<ul style="list-style-type: none"> ▶ Mélange air/carburant trop riche ▶ Plage thermique incorrecte (trop froide) ▶ Retard à l'allumage ▶ Écartement incorrect des électrodes ▶ Consommation d'huile 	<ul style="list-style-type: none"> ✓ Régler le mélange air/carburant ✓ Contrôler l'indice thermique ✓ Vérifier le retard à l'allumage ✓ Vérifier l'écartement des électrodes ✓ Vérifier la consommation d'huile
 <p>Surchauffe Électrodes fondues, soudées</p>	<ul style="list-style-type: none"> ▶ Plage thermique incorrecte ▶ Avance à l'allumage ▶ Refroidissement insuffisant ▶ Mélange air/carburant trop pauvre ▶ Bougie mal serrée 	<ul style="list-style-type: none"> ✓ Vérifier la préconisation bougie ✓ Vérifier l'avance à l'allumage ✓ Vérifier un problème de refroidissement ✓ Vérifier la qualité du mélange ✓ Serrer la bougie au couple préconisé à l'aide d'une clé dynamométrique
 <p>Dépôts Mauvais allumage ou pas d'allumage</p>	<ul style="list-style-type: none"> ▶ Mauvaise qualité du carburant ▶ Mauvaise qualité de l'huile ▶ Mauvais état moteur 	<ul style="list-style-type: none"> ✓ Vérifier le carburant utilisé ✓ Vérifier la qualité de l'huile utilisé ✓ Contrôle moteur
 <p>Céramique cassée ou fendue Mauvais allumage ou pas d'allumage</p>	<ul style="list-style-type: none"> ▶ Chocs mécaniques ▶ Chocs thermiques ▶ Vibrations moteur ▶ Mauvaise étanchéité ▶ Bougie mal serrée 	<ul style="list-style-type: none"> ✓ Vérifier l'état du joint de culasse ✓ Vérifier un problème de vibrations moteur ✓ Serrer la bougie au couple préconisé à l'aide d'une clé dynamométrique
 <p>Filetage arraché</p>	<ul style="list-style-type: none"> ▶ Utilisation d'un outil inadapté ▶ Couple appliqué trop élevé 	<ul style="list-style-type: none"> ✓ Utiliser une clé dynamométrique ✓ Respecter la couple préconisé



BOUGIES HAUTES PERFORMANCES

// Les bougies d'allumage hautes performances ont été développées pour l'origine afin de répondre aux cahiers des charges des constructeurs et aux normes anti-pollution de plus en plus contraignantes.

// La gamme Iridium IX permet de proposer cette technologie pour un grand nombre de véhicules.

Pointe en alliage d'iridium

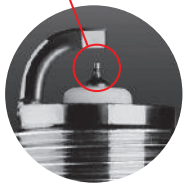

Électrode de masse biseautée

Technologie "2 steps" (escaliers) : évite l'encrassement de l'isolant

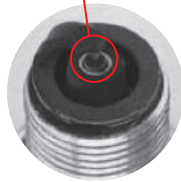

Point de départ de la flamme

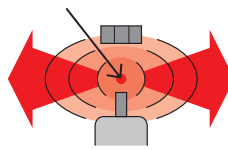

L'électrode centrale étant très fine, la flamme se propage plus amplement

Étincelle

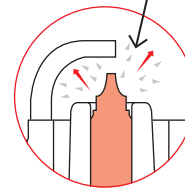

Dépôt de carbone

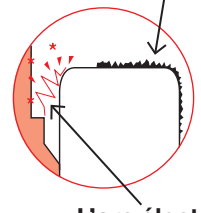

L'arc électrique élimine les dépôts de carbone

COMBUSTION OPTIMISÉE

Jusqu'à 5% d'économie de carburant

Consommation en litres

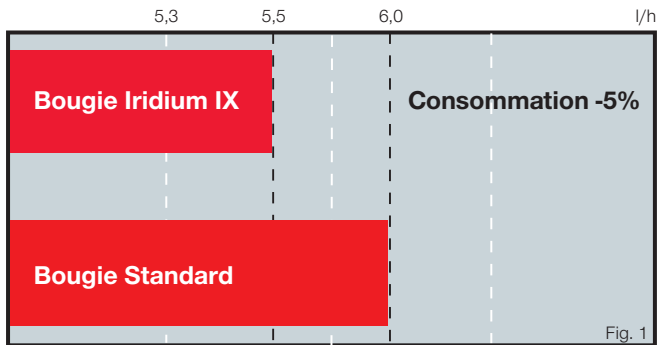

Optimisez vos performances

Meilleure accélération

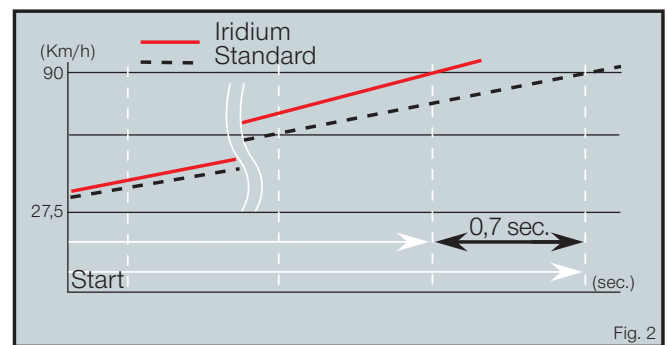

AVANTAGES

// Consommation réduite (Fig. 1)

// Moins de polluants

// Meilleures performances (Fig. 2)

// Confort de conduite accru

// Protection du pot catalytique

// Conduite urbaine favorisée (anti-encrassement)

// Durée de vie optimisée

Consultez la table de correspondances Bougies standard ► Bougies IX en page 6.



BOUGIES IRIDIUM IX

TABLE DE CORRESPONDANCES

Déterminer la bougie d'origine puis la bougie IX correspondante.

PRÉCONISATION			
NGK ORIGINE		IRIDIUM IX	
Réf.	N°Stock	IX	N°Stock IX
B6HS	4510	BR6HIX	3419
B7ES	1111	BR7EIX	6664
B7HS	5110	BR7HIX	7067
B8ES	2411	BR8EIX	5044
B8HS	5510	BR8HIX	7001
B9ES	2611	BR9EIX	3981
B9HS	5810	BR9HIXw	5687
B10ES	7928	BR10EIX	6801
B10HS	2399	BR10HIX	6692
BCPR6E	6129	BCPR6EIX	5689
BCPR7ET	2164	BCPR7EIX	5690
BKR5E	7938	BKR5EIX	6341
BKR5E-11	6953	BKR5EIX-11	5464
BKR6E	6962	BKR6EIX	6418
BKR6E-11	2756	BKR6EIX-11	3764
BKR6EKC	2848	BKR6EIX	6418
BKR7E-11	1283	BKR7EIX-11	6988
BKR7EKC	7354	BKR7EIX	2667
BP5ES	6511	BPR5EIX	6597
BP5ES-11	7311	BPR5EIX-11	2115
BP6ES	7811	BPR6EIX	6637
BP6HS	4511	BPR6HIX	4085
BP6HSA	1046	BPR6HIX	4085
BP7ES	2412	BPR7EIX	4055
BP7HS	5111	BPR7HIX	5944
BP8ES	2912	BPR8EIX	6684
BP8HS	2630	BPR8HIX	6742
BP9ES	7526	BPR9EIX	6853
BPR5ES	7422	BPR5EIX	6597
BPR5ES-11	4424	BPR5EIX-11	2115
BPR6E	2268	BPR6EIX	6637
BPR6ES	7822	BPR6EIX	6637
BPR6HS	7022	BPR6HIX	4085
BPR6HSA	4632	BPR6HIX	4085
BPR7ES	2023	BPR7EIX	4055
BPR7HS	6422	BPR7HIX	5944
BPR8ES	3923	BPR8EIX	6684
BPR8HS	3725	BPR8HIX	6742
BPR8HSA	7937	BPR8HIX	6742
BR6HS	3922	BR6HIX	3419
BR6HSA	4296	BR6HIX	3419
BR7ES (OD/OM*)	5122/6615	BR7EIX (OD*)	6664
BR7HS	4122	BR7HIX	7067
BR8ECM	3035	BR8ECMIX	3520
BR8ES (OD/OM*)	5422/3961	BR8EIX (OD*)	5044
BR8HS	4322	BR8HIX	7001
BR8HSA	5539	BR8HIX	7001
BR9ECM	3252	BR9ECMIX	2707
BR9ES (OD/OM*)	5722/3194	BR9EIX (OD*)	3981
BR9EYA	7548	BR9EIX	3981
BR9HS	4522	BR9HIX	5687

PRÉCONISATION			
NGK ORIGINE		IRIDIUM IX	
Réf.	N°Stock	IX	N°Stock IX
BR10ECM	4234	BR10ECMIX	3006
BR10ES	4832	BR10EIX	6801
C6HSA	3228	CR6HIX	7274
C7E	5096	CR7EIX	7385
C7HSA	4629	CR7HIX	7544
C8E	7471	CR8EIX	4218
C8EH-9	7473	CR8EHIX-9	3797
C8HSA	6821	CR8HIX	7669
C9E	7499	CR9EIX	3521
C9EH-9	2142	CR9EHIX-9	6216
CPR7EA-9	3901	CPR7EAIX-9	9198
CR5HSA	7840	CR5HIX	7120
CR5HSB	6535	CR5HIX	7120
CR6HS	7023	CR6HIX	7274
CR6HSA	2983	CR6HIX	7274
CR7E (OD*)	4578	CR7EIX (TF*)	7385
CR7EB (OM*)	4663	CR7EIX (TF*)	7385
CR7EK	7546	CR7EIX	7385
CR7HSA	4549	CR7HIX	7544
CR7HSA-9	5147	CR7HIX	7544
CR8E (OD*)	1275	CR8EIX (TF*)	4218
CR8EB (OM*)	7784	CR8EIX (TF*)	4218
CR8EH-9	5666	CR8EHIX-9	3797
CR8EK	3478	CR8EIX	4218
CR8HSA	2086	CR8HIX	7669
CR9E (OD*)	6263	CR9EIX (TF*)	3521
CR9EB (OM*)	6955	CR9EIX (TF*)	3521
CR9EH-9	7502	CR9EHIX-9	6216
CR9EK	4548	CR9EIX	3521
CR10E	6264	CR10EIX	6482
CR10EK	2360	CR10EIX	6482
D8EA	2120	DR8EIX	6681
D9EA	2420	DR9EIX	4772
DR7EA	7839	DR7EIX	5686
DCPR6E	3481	DCPR6EIX	8196
DCPR7E (OD/OM*)	3932/4415	DCPR7EIX (OD*)	6046
DCPR8E (OD/OM*)	4339/4179	DCPR8EIX (OD*)	6546
DCPR9E	2641	DCPR9EIX	2316
DP7EA-9	5629	DPR7EIX-9	7803
DP8EA-9	5829	DPR8EIX-9	2202
DP9EA-9	6629	DPR9EIX-9	5545
DPR7EA-9	5129	DPR7EIX-9	7803
DPR8EA-9	4929	DPR8EIX-9	2202
DPR9EA-9	5329	DPR9EIX-9	5545
DR8EA (TF*)	7162	DR8EIX (TF*)	6681
DR8EB (OM*)	4855	DR8EIX (TF*)	6681
DR8ES-L (TF*)	2923	DR8EIX (TF*)	6681
DR9EA	3437	DR9EIX	4772
ER8EH	4011	ER8EHIX	8201
ER8EH-N	5606	ER8EHIX	8201
ER9EH	5869	ER9EHIX	96652

*OD : Olive Démontable

*OM : Olive Monobloc

*TF : Tige Filetée



BOUGIES COMPÉTITION RACING

CARACTÉRISTIQUES DES BOUGIES RACING



- // Conçues pour des moteurs à **taux de compression et régimes élevés**
- // Électrodes centrales en **métaux précieux** (Iridium, Platine, Or-Palladium) pour répondre à des conditions d'utilisation sévères
- // **Plage thermique froide** pour une bonne évacuation de la chaleur

CHOIX D'UNE RÉFÉRENCE

- // Déterminer la référence standard à l'aide du tableau ci-dessous
- // Choisir la référence compétition correspondante
- // Choisir l'indice thermique, les matériaux, le terminal et la tête de l'éclateur (Cf. colonne VUE)

	DIMENSIONS	BOUGIE STANDARD	BOUGIE COMPÉTITION	INDICE THERMIQUE	ÉLECTRODE		TERMINAL	VUE		
					CENTR.	MASSE				
A 	Ø 8x19 (12.7) mm (clé 13mm)	E-EH (Semi fileté)	R847-#	10	N	-	TF	F		
	Ø 10x12,7mm (clé 16mm)	C-H	R0161-#	9, 10	N	N	OD	A		
	Ø 10x19,0 (12.7) mm (clé 16mm)	C-EH (Semi fileté)	R04009B-#	8, 9, 10	I	N	TF	G		
B 	Ø 10x19mm (clé 16mm)	C-E	R0373A-#	9, 10, 11	I	PL	TF	G		
		Gap: 1,40mm	R0045G-#	10, 11	N	-	TF	F		
		Gap: 1,10mm	R0045J-#	9, 10, 11	N	-	TF	F		
		Gap: 1,10mm	R0045Q-#	10, 11	N	-	TF	F		
C 	Ø 10x26,5mm (clé 14mm)	LMAR	R0451B-#	8	I	N	OM	G		
			R0451C-#	10	I	N	TF	G		
			R0465B-#	10	N	-	TF	F		
D 	Ø 12x19mm (clé 16mm)	DC-E	R2349-#	9, 10, 11	N	-	OM	F		
			R2525-#	9, 10	P	N	OD	G		
			Ø 12x26,5mm (clé 14mm)	LKAR	R2558A-#	8, 9	I	PL	OM	G
				LKR	R2556B-#	8, 9, 10	I	PL	OM	G
E 	Ø 14x12,7mm (clé 20,8mm)	B-H	R5525-#	8, 9, 10, 11	O/P	N	OD	A		
			R5530-#	9, 10	O/P	PL	TF	B		
			BC-E	R6601-#	8, 9, 10, 11	N	-	OM	F	
				R6690-#	9, 10, 11	N	-	OM	F	
				R7429A-#	10	P	PL	OM	B	
			Ø 14x19mm (clé 16mm)	R7434-#	8, 9, 10	I	PL	OM	G	
				R7436-#	8, 9, 10	I	PL	OM	G	
				BCPE	R7435-#	8, 9, 10	I	N	OM	H
				BK-E	R7433-#	8, 9, 10	I	N	OM	H
				Short	R7282-#	10, 105, 11	I	PL	OM	G
			F 	Ø 14x19mm (clé 20,8mm)	B-E	R7282M-#	11, 115	I	PL	OM
B#EGP	8, 85, 95, 10, 105, 11	O/P				PL	OD	B		
B#EGV	8, 85, 9, 95, 10, 105, 11	O/P				N	OD	A		
R4118S-#	8, 9, 10, 105	O/P				N	OD	A		
R5184-#	10, 105	O/P				PL	OD	B		
Gap: 0,60 mm	R6252E-#	9, 105				N	N	OM	E	
Gap: 0,80 mm	R6252K-#	105				N	N	OM	E	
R6254E-#	9, 105	N				N	OM	E		
R6254K-#	105	N				N	OM	E		
R6712-#	9, 10	N				-	TF	F		
R6918B-#	7, 8, 9	P				N	OM	I		
R6918C-#	9	P				N	OM	I		
R7376-#	8, 9, 10	I				PL	OM	G		
BP-E	R4304A-#	7, 8, 9, 10	O/P	N	OD	C				
	Short	R5300A-#	95, 10	N	PL	OM	B			
Ø 14x22mm (clé 16mm)	Short	R5540F-#	105	N	PL	OM	B			
		R7282A-#	105, 11	I	PL	OM	G			
		LFR	R7437-#	8, 9, 10	I	N	OM	H		
I 	Ø 14x26,5mm (clé 16mm)	Short	R7438-#	8, 9, 10	I	PL	OM	G		

*OD - Olive Démontable
*OM - Olive Monobloc

*TF - Tige Filetée
*O/P : Or/Palladium

*N : Alliage de Nickel
*PL : Platine

*I : Iridium
En gras : Bougie résistive

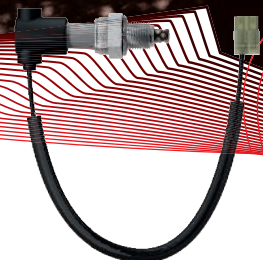

CYCLOS / MOTOS



GAMME BLISTERS CYCLOS / MOTOS



- // 14 références ► Gamme compacte
- // Couverture : 90% du parc 2 roues 50 - 250 cm³, 2-15 ans et +
- // Cyclos / Motos, Quads, Motonautisme, Motoneige

N° Blister Réf.	N° Stock	APPLICATIONS
01 BR8HS	4967	APRILIA 50 Area, Sonic, SR, 100 Scarabeo - BENELLI 50 - KTM 50 SX, 125 EXE MBK 50 Booster, Nitro, Stunt - YAMAHA 50 Aeorx, BW's
02 BR9ES	5061	APRILIA 50 Scarabeo 2T, Sporcity - DERBI 50 Senda, GPR - GAS GAS 50 SM, 325 PXC - HUSQVARNA 50 CR/SM, 400 MX MBK 50 X-Limit - PEUGEOT 50 XP6, XR6, XR7 - PIAGGIO 50 Vespa LX/S, NRG, Zip - SHERCO 50 SE-R/SM-R
03 BR7HS	5417	CPI 50 GTR/GTS - MBK 50 Booster, Dakota, Evolis, Phoenix, 51 PEUGEOT 50 Blaster, Ludix, Trekker, Vivacity - PIAGGIO 125 Vespa PX
04 CR8E	5671	APRILIA 125 Sport City - ARCTIC CAT Quad 350 CR, 400 TRV - HONDA 125 CBR - HUSQVARNA 125 SMS/TE - KAWASAKI 250 KX-F KYMCO 500 Xciting - KYMCO Quad 400/500 MXU - SUZUKI 125 Address, Burgman, Van Van, 650 Burgman, GSF Bandit, GSX-F, SV SYM 125 Euro MX, Joyride, GTS - YAMAHA 125 Majesty, 450 YZF, 600 Fazer, 1300 FJR - YAMAHA Quad 700 YFM Raptor
05 BR8ES	1876	DERBI 50/125 GPR - MBK 50 X-Limit, X-Power, 51 Magnum - MOTO GUZZI 750 V7 PEUGEOT 100 Looxor, Speedfight, Vivacity - SHERCO 250 & 300 SE/SE-R - YAMAHA 50 DT, TZR, 125 DT, TDR
06 CR9E	5995	APRILIA 125 Mojito Custom - GAS GAS 250 ECF - KAWASAKI 600 ZX-6 Ninja SUZUKI 600 GSR, GSX-R, 750 GSX-R, 1000 GSX-R, 1300 GSX-R Hayabusa - YAMAHA 250 TTR, 600 FZR/YZF, 800 FZ-8
07 CR7HSA	6016	ARCTIC CAT Quad 50/90 DVX, Utility, Youth - HONDA Quad 90 TRX - KAWASAKI 125 KLX KYMCO 50 Agility, Dink, 125 Agility, People, 200 Like - PEUGEOT 50 V-Clic, 125 Tweet, Vivacity - SYM 50/125 Fiddle, Simply YAMAHA 50 TT-R, 125 BW's, TT-R - YAMAHA Quad 50/80/125/500 YFM
08 DPR8EA-9	6570	DERBI 125 Senda R - HONDA 650 Transalp, 750 Shadow, 1300 CB - HONDA Quad 250/300/400 TRX - SUZUKI 650 GSF Bandit TRIUMPH 790 America, 865 America, Bonneville, Scrambler, Speedmaster, Thruxton YAMAHA 250 X-City, X-Max, 1200 XJR, V-Max, 1854 Roadliner
09 BR6HS	6676	MBK 51 Magnum, Club Swing - MOTOBECANE 50 - PEUGEOT 101, 102, 103 - KYMCO Quad 50 Tomos PIAGGIO 50 Vespa, 150 Vespa PX - VELOSOLEX 50 GL/GR/GS Ténor - YAMAHA 50 Chappy, DT
10 CR8EH-9	6791	DAELIM 125 Classic, Daystar, Freewing, Roadwin - HONDA 125 FES Silver Wing, PS, SES Dylan, SH Scoopy, VT Shadow, Varadero, 150 CRF, FES S-Wing, 250 CBF, 400 FJS Silverwing, 500 CB, 600 CBF Hornet, 750 VFR, 1000 CBF, 1100 ST Pan-European HYOSUNG 125 Karion, GT, XRX Trail
11 DR8EA	6847	APRILIA 250 Leonardo, 300 Leonardo ST, 600/650 Pegaso - BMW F 650 GS - BOMBARDIER Quad 500 Traxter, 650 DS CCM 604 Supermoto Dual Sport, Roadster RS, Trail Dual Sport - DERBI 125 Cross City, Senda Baja - HYOSUNG 125 GPS Grand Prix KAWASAKI Quad 300 KLF/KVF - KTM 400 LC4 EGS/SC/SXC, 620 LC4 Duke/Rally, 640 LC4 Adventure R/Duke II KYMCO 125 CK, Hipster, Meteorit, People, Pulsat, Zing II - MBK 300 Killbre - SUZUKI 125 DR, DR-Z, GN, GZ Marauder YAMAHA 125 SR, TW, XT, 250 XTZ, YBR, YP Majesty, YP X-Max, 1000 FZR, YZF - YAMAHA Quad 350 YFM, 450 YFM
12 CR7E	7513	APRILIA 650 Pegaso ie - ARCTIC CAT Quad 400/450/500/650 - DERBI 659 Mulhacen - KAWASAKI 125 BN, 800 VN KAWASAKI Quad 400/700 KFX, 650/750 KVF - KYMCO 125 Dink Street, Downtown, 200 Downtown, People GT, 300 Dink Street, Downtown, People GT, Xciting - KYMCO Quad 500 MXU - MBK 50 Ovetto 4, 125 Flame - PEUGEOT 125 Elyséo, LXR SUZUKI 125 Marauder, 400 Burgman, 650 DL V-Strom, 1250 GSF Bandit, GSX-F - SUZUKI Quad 400 KingQuad, QuadSport YAMAHA 50 XF Giggie, YN Neo's 4T, 125 XC Cygnus, XP Majesty, 400 Majesty, T-Max, 660 MT-03, XTR
13 DPR7EA-9	5262	ARCTIC CAT Quad 250 & 300 DVX/Utility - HONDA 250 Forza, Jazz, 750 VT Shadow - HONDA Quad 350/400/450 TRX KYMCO 125 Dink 4T, Grand Dink, Spacer, Yager, 250 Ego, Grand Dink, People, Xciting - KYMCO Quad 250/300 Maxxer, MXU PEUGEOT 250 SV - SUZUKI Quad 160 LT-E/LT-F
14 BPR7HS	6873	APRILIA 50 Quasar, SR, 100 Quasar - ARCTIC CAT Quad 50 Y-6, 90 Y-12 - BOMBARDIER Quad 50/90 DS POLARIS Quad 50 Predator, Scrambler, 90 Predator, Youth Predator/ Scrambler/Sportsman

GAMME BLISTERS ANTIPARASITES

- // 4 références
- // Antiparasitage optimum
- // Étanche et robuste

N° Blister	NGK	N° Stock	MARQUES
01	LB05E	6721	APRILIA, BMW, CAGIVA, GAS GAS, GILERA, HONDA, KAWASAKI, KTM, MBK, MOTOBECANE, MOTO GUZZI, PEUGEOT, PIAGGIO, SUZUKI, YAMAHA
02	LB10F	8961	
03	LB05F	7981	
04	LB10E	9334	





CYCLOS / MOTOS

SOMMAIRE



BOUGIES D'ALLUMAGE

12 à 98 Applications bougies d'allumage



CAPUCHONS ANTIPARASITES

100 Signification des références - Technologies

101 à 109 Caractéristiques Techniques - Raccords

110 Antiparasites avec câbles

111 Antiparasites de compétition et câbles Racing

112 à 124 Applications capuchons antiparasites



SONDES LAMBDA

126 à 127 Caractéristiques techniques

128 à 129 Schémas des connecteurs

130 à 133 Applications sondes Lambda

STOCK-TYPE

134 Stock-type bougies d'allumage



BOUGIES D'ALLUMAGE



CYL. Nb Cyl. TYPE MODÈLE



INFO



N° STOCK

N° BLISTER



N° STOCK IX



ACCESS - Quad

50	1		Long	-	0,60	BR8HSA	5539	-	BR8HIX	7001
50	1		Streak	-	0,80	BR8HSA	5539	-	BR8HIX	7001
100	1		Long	-	0,80	BR8HSA	5539	-	BR8HIX	7001



ADLY - Quad

50	1			-	0,60	BP7HS	5111	14	BPR7HIX	5944
50	1	RS	Supersonic	07-	0,70	BPR7HS	6422	14	BPR7HIX	5944
125	1		Buggy	-	0,80	CR7HSA	4549	07	CR7HIX	7544
150	1			-	0,70	CR8E	1275	04	CR8EIX	4218
176	1		Sentinel	-	0,70	CR8E	1275	04	CR8EIX	4218
220	1		Cross Sentinel	-	0,70	CR8E	1275	04	CR8EIX	4218
300	1		ATV 300	-	0,70	DR8ES-L	2923	-	DR8EIX	6681
300	1	RS	Interceptor	07-	0,70	DR8ES-L	2923	-	DR8EIX	6681



AEON - Quad

50	1	H	Cobra 4x2	03-	0,80	BPR7HS	6422	14	BPR7HIX	5944
50	1		Minikolt 4x2	03-	0,80	BPR7HS	6422	14	BPR7HIX	5944
50	1		Revo	04-	0,80	BPR7HS	6422	14	BPR7HIX	5944
100	1	H	Cobra 4x2	02-	0,80	BPR7HS	6422	14	BPR7HIX	5944
100	1		Revo	04-	0,80	BPR7HS	6422	14	BPR7HIX	5944
125	1		Cobra Sport 4x2	02-	0,80	CR8HSA	2086	-	CR8HIX	7669
125	1		Cobra Utility, Cobra RS 1&2	02-	0,80	CR7HSA	4549	07	CR7HIX	7544
125	1		Overland	04-	0,80	CR7HSA	4549	07	CR7HIX	7544
180	1		Cobra Overland, Cobra RS 1&2	04-	0,80	CR7HSA	4549	07	CR7HIX	7544
180	1		Cobra Sport 4x2, Cobra Utility 4x2	02-	0,80	CR8HSA	2086	-	CR8HIX	7669
180	1		LG 180	05-	0,80	CR7HSA	4549	07	CR7HIX	7544
180	1		Overland	04-	0,80	CR7HS	7223	-	-	-
180	1		Overland II	05-	0,80	CR7HSA	4549	07	CR7HIX	7544
180	1		Utility	02-	0,80	CR7HS	7223	-	-	-
220	1		Cobra	05-	0,60	CR7HSA	4549	07	CR7HIX	7544





ALFER





50	1		GR 30, TX 30	-	0,60	BR8HS	4322	01	BR8HIX	7001
80	1	MC		-	0,50	B9EGV	5827	-	-	-
125	1		Trail	00-	0,70	CR9EB	6955	06	CR9EIX	3521
125	1	GR	ISDE	-	0,50	B8EGV	5627	-	-	-
125	1	MC		-	0,50	B9EGV	5827	-	-	-
125	1	VRE	4 temps, No Limit 4 temps	-	0,70	CR9E	6263	06	CR9EIX	3521
250	1	EGR		-	0,50	B8ES	2411	05	BR8EIX	5044
250	1	MC		-	0,50	B9EGV	5827	-	-	-
250	1	VR	Enduro, Super Motard	00-	0,60	BR8ES	5422	05	BR8EIX	5044
300	1		AR-1, Agua	-	0,50	B8ES	2411	05	BR8EIX	5044
300	1	TX		-	0,50	B8ES	2411	05	BR8EIX	5044
490	1	MC	500	-	0,50	B9EGV	5827	-	-	-







APRILIA

25	1		Amico 25	96-	0,50	BR7HS	4122	03	BR7HIX	7067
50	1		Amico 50	90-01	0,50	BR7HS	4122	03	BR7HIX	7067
50	1		Area 51 Superbike, Tetsuya	99-03	0,50	BR8HS	4322	01	BR8HIX	7001
50	1		Classic	98-99	0,50	BR8ES	5422	05	BR8EIX	5044

CYL.	Nb Cyl.	TYPE	MODÈLE		INFO			N° STOCK	N° BLISTER		N° STOCK IX
50	1		Extrema 50	93-		0,50	B8ES	2411	05	BR8EIX	5044
50	1		Gulliver AC	95-01		0,50	BR7HS	4122	03	BR7HIX	7067
50	1		Gulliver LC	97-01		0,50	BR8HS	4322	01	BR8HIX	7001
50	1		Habana	99-02		0,60	BPR8HS	3725	-	BPR8HIX	6742
50	1		Mojito Custom 50	02-03		0,60	BPR8HS	3725	-	BPR8HIX	6742
50	1		Mojito Custom 50	04-		0,60	BR10ES	4832	-	BR10EIX	6801
50	1		Mojito Custom 50	05-		0,70	BR9ES	5722	02	BR9EIX	3981
50	1		Quasar	02-03		0,70	BPR7HS	6422	14	BPR7HIX	5944
50	1		Rally AC	95-03		0,50	BR7HS	4122	03	BR7HIX	7067
50	1		Rally LC	97-03		0,50	BR8HS	4322	01	BR8HIX	7001
50	1		Red Rose 50	93-		0,50	B8ES	2411	05	BR8EIX	5044
50	1		Scarabeo 50 2 temps	93-05		0,50	BR7HS	4122	03	BR7HIX	7067
50	1		Scarabeo 50 2 temps (Moteur C421M)	04-		0,60	BR9ES	5722	02	BR9EIX	3981
50	1		Scarabeo 50 4 temps	01-03		0,70	CR8EB	7784	04	CR8EIX	4218
50	1		Scarabeo 50 4 temps	04-		0,70	CR9EB	6955	06	CR9EIX	3521
50	1		Scarabeo 50 4 temps (Moteur C376M)	06-		0,70	PMR7A	4259	-	-	-
50	1		Scarabeo 50 Di Tech (Injection)	00-04		0,80	CPR8E	7411	-	-	-
50	1		Scarabeo 50 ie	01-03		0,60	CPR8E	7411	-	-	-
50	1		Sonic 50 AC	98-03		0,50	BR7HS	4122	03	BR7HIX	7067
50	1		Sonic 50 Euro 2	03-		0,60	BR8HS	4322	01	BR8HIX	7001
50	1		Sonic 50 LC	98-03		0,60	BR8HS	4322	01	BR8HIX	7001
50	1		Sonic FT 50 2 temps (Ref. Air)	98-01		0,50	BR8HS	4322	01	BR8HIX	7001
50	1		Sonic GP 50 2 temps (Ref. Liquide)	98-05		0,50	BR8HS	4322	01	BR8HIX	7001
50	1		Sportcity One 50 2T Street	08-		0,60	BR9ES	5722	02	BR9EIX	3981
50	1		Sportcity One 50 4T	08-		0,70	PMR7A	4259	-	-	-
50	1		Tuono	03-04		0,60	BR9ES	5722	02	BR9EIX	3981
50	1	MX	Moteur AM6	02-04		0,70	BR9ES	5722	02	BR9EIX	3981
50	1	RX		88-96		0,50	B9ES	2611	02	BR9EIX	3981
50	1	RX		96-		0,50	BR8ES	5422	05	BR8EIX	5044
50	1	RX		06		0,60	BR9ES	5722	02	BR9EIX	3981
50	1	RX	Racing (Moteur Minarelli)	03-04		0,60	BR9ES	5722	02	BR9EIX	3981
50	1	RS		93-96		0,50	B8ES	2411	05	BR8EIX	5044
50	1	RS		97-05		0,80	BR8ES	5422	05	BR8EIX	5044
50	1	RS		06-		0,60	BR9ES	5722	02	BR9EIX	3981
50	1	SR		92-95		0,50	BR7HS	4122	03	BR7HIX	7067
50	1	SR	Carb	04-		0,60	BR9ES	5722	02	BR9EIX	3981
50	1	SR	Di Tech (ref. liquide)	06-		0,60	ZMR7AP	6914	-	-	-
50	1	SR	i.e. Factory	05-		0,60	CPR8E	7411	-	-	-
50	1	SR	LC	96-		0,70	BR7HS	4122	03	BR7HIX	7067
50	1	SR	Motard 50 2T	12-		0,50	BR9ES	5722	02	BR9EIX	3981
50	1	SR	Motard	14-		0,80	BR8ES	5422	05	BR8EIX	5044
50	1	SR	Moteur Aprilia L02 (ref. liquide)	00-03		0,60	BPR8HS	3725	-	BPR8HIX	6742
50	1	SR	Moteur Minarelli ref. air	93-01		0,50	BR7HS	4122	03	BR7HIX	7067
50	1	SR	Moteur Minarelli ref. liquide	94-01		0,60	BR8HS	4322	01	BR8HIX	7001
50	1	SR	Racing & Sport (ref. liquide)	00-		0,70	BPR7HS	6422	14	BPR7HIX	5944
50	1	SR	Ref.liquide - Tous modèles	96-99		0,60	BR8HS	4322	01	BR8HIX	7001
50	1	SR	R (moteur Piaggio)	04-		0,80	BR9ES	5722	02	BR9EIX	3981
50	1	SR	Racing, Stealth	96-		0,70	BR7HS	4122	03	BR7HIX	7067
50	1	SR	Street (moteur Piaggio)	04-		0,80	BR9ES	5722	02	BR9EIX	3981
50	1	SR	WWW	01-02		0,60	BR7HS	4122	03	BR7HIX	7067
50	1	SX		06-		0,60	BR9ES	5722	02	BR9EIX	3981
50	1	SX	Moteur Piaggio	08-		0,60	BR9ES	5722	02	BR9EIX	3981
100	1		Quasar	02-03		0,70	BPR7HS	6422	14	BPR7HIX	5944
100	1		Scarabeo 2 temps	00-02		0,60	BR8HS	4322	01	BR8HIX	7001
100	1		Scarabeo 4 temps	00-		0,70	CR9EB	6955	06	CR9EIX	3521
125	1		Atlantic	03-		0,70	CR8EB	7784	04	CR8EIX	4218
125	1		Classic (15ch)	96-02		0,50	BR8ES	5422	05	BR8EIX	5044
125	1		Classic (Full Power)	96-02		0,50	BR10EG	3830	-	-	-
125	1		Europa, Extrema	-		0,50	BR10EG	3830	-	-	-
125	1		Habana & Custom	99-		0,60	CR8E	1275	04	CR8EIX	4218
125	1		Leonardo 125 / ST	95-02		0,60	CR8E	1275	04	CR8EIX	4218
125	1		Leonardo 125 ST	02-06		0,60	CR8EB	7784	04	CR8EIX	4218
125	1		Mojito	02-04		0,60	CR8E	1275	04	CR8EIX	4218
125	1		Mojito Custom	02-		0,80	CR7EB	4663	12	CR7EIX	7385
125	1		Mojito Custom	05-		0,70	CR9E	6263	06	CR9EIX	3521

CYL.	Nb Cyl.	TYPE	MODÈLE		INFO			N° STOCK	N° BLISTER		N° STOCK IX
125	1		Pegaso	-		0,50	BR10EG	3830	-	-	-
125	1		Quasar	02-03		0,70	CR8HSA	2086	-	CR8HIX	7669
125	1		Scarabeo	99-09		0,60	CR8EB	7784	04	CR8EIX	4218
125	1		Scarabeo 125 i.e	09-		0,70	PMR9B	4717	-	-	-
125	1		Scarabeo GT, Scarabeo Light	99-		0,60	CR8E	1275	04	CR8EIX	4218
125	1		Scarabeo Street	06-		0,70	CR9EB	6955	06	CR9EIX	3521
125	1		Sport City 125	04-08		0,60	CR8E	1275	04	CR8EIX	4218
125	1		Sport City One	08-		0,80	CR7EB	4663	12	CR7EIX	7385
125	1		Sport City Cube	08-		0,80	CR8EB	7784	04	CR8EIX	4218
125			Sport Pro 125, Touareg Rallye & Wind	-		0,50	BR10EG	3830	-	-	-
125	1		Tuono 15 ch	03-04		0,80	BR8ES	5422	05	BR8EIX	5044
125	1	ETX		84-98		0,50	B9ES	2611	02	BR9EIX	3981
125	1	ETX	15 ch	98-		0,50	BR8ES	5422	05	BR8EIX	5044
125	1	ETX	Moteur Rotax	99-02		0,80	BR8ES	5422	05	BR8EIX	5044
125	1	ETX	Full Power	98-		0,50	BR10EG	3830	-	-	-
125	1	MX		03-06		0,80	BR8ES	5422	05	BR8EIX	5044
125	1	RS	Extrema	93-		0,50	BR10EG	3830	-	-	-
125	1	RS	15 ch	96-		0,50	BR8ES	5422	05	BR8EIX	5044
125	1	RS	Full Power	96-		0,50	BR10EG	3830	-	-	-
125	1	RS	Replica	93-		0,50	BR10EG	3830	-	-	-
125	1	RS	R Extrema 12 ch	93-		0,50	BR8ES	5422	05	BR8EIX	5044
125	1	RS	Tuono	03-		0,60	BR8ES	5422	05	BR8EIX	5044
125	1	RS4		11-		0,50	CR9EB	6955	06	CR9EIX	3521
125	1	RX	15 ch	08-		0,50	BR8ES	5422	05	BR8EIX	5044
125	1	RX	Full Power	08-		0,50	BR10EG	3830	-	-	-
125	1	SR		99-02		0,50	BR8ES	5422	05	BR8EIX	5044
125	1	SR	MAX	11-		0,70	CR8EKB	4374	-	CR8EIX	4218
125	1	SR	Motard	12-		0,70	CR7EB	4663	12	CR7EIX	7385
125	1	SX	15 ch	08-		0,50	BR8ES	5422	05	BR8EIX	5044
125	1	SX	Full Power 34.6ch	08-		0,70	BR10EG	3830	-	-	-
150	1		Leonardo	97-02		0,60	CR8E	1275	04	CR8EIX	4218
150			Leonardo 150 ST	02-		0,60	-	-	-	CR8EIX	4218
150	1		Mojito 150	03-06		0,70	CR7EB	4663	12	CR7EIX	7385
150			Scarabeo 150 (4-T)	99-03		0,60	CR8E	1275	04	CR8EIX	4218
150	1	SR		99-02		0,60	BR9ES	5722	02	BR9EIX	3981
180	1		Quasar	02-04		0,70	CR8HSA	2086	-	CR8HIX	7669
200	1		Atlantic	02-05		0,70	CR8EB	7784	04	CR8EIX	4218
200	1		Scarabeo	00-09		0,80	CR8EB	7784	04	CR8EIX	4218
200	1		Scarabeo i.e.	09-		0,70	PMR9B	4717	-	-	-
200	1		Scarabeo Street	06-		0,70	CR9EB	6955	06	CR9EIX	3521
200	1		Sportcity 200	04-08		0,60	CR7EB	4663	12	CR7EIX	7385
200	1		Sportcity 200	08-		0,80	CR8EB	7784	04	CR8EIX	4218
250	1		Atlantic 250	04-06		0,70	CR8EB	7784	04	CR8EIX	4218
250	1		Atlantic 250 i.e.	04-09		0,70	PMR8B	6378	-	-	-
250	1		Leonardo	99-		0,60	DR8EA	7162	11	DR8EIX	6681
250	1		Scarabeo 250	04-06		0,70	CR8EB	7784	04	CR8EIX	4218
250	1		Scarabeo ie	06-		0,70	PMR8A	5851	-	-	-
250	1		Sportcity 250 i.e.	06-		0,70	PMR8B	6378	-	-	-
250	1		Sport City Cube	08-		0,80	CR8EB	7784	04	CR8EIX	4218
250	1	RS		95-03		0,50	BR9ECM	3252	-	BR9ECMIX	2707
300	1		Atlantic	09-		0,70	CR8EKB	4374	-	CR8EIX	4218
300	1		Leonardo	04-07		0,60	DR7EA	7839	-	DR7EIX	5686
300	1		Leonardo (PD) (SV)	98-00		0,60	DR7EA	7839	-	DR7EIX	5686
300	1		Leonardo ST	05-		0,60	DR8EA	7162	11	DR8EIX	6681
300	1		Scarabeo	09-		0,70	CR8EKB	4374	-	CR8EIX	4218
300	1		Sport City Cube 300	08-		0,70	CR8EKB	4374	-	CR8EIX	4218
300	1	SR	MAX	11-		0,70	CR8EKB	4374	-	CR8EIX	4218
400	1		Atlantic Sprint	06-		0,70	CR7EKB	4455	-	CR7EIX	7385
400	1		Scarabeo ie	07-		0,70	CR7EKB	4455	-	CR7EIX	7385
450	2	MXV	4.5	09-		0,70	CR8EKB	4374	-	CR8EIX	4218
450	2	RXV/SXV	4.5	06-		0,70	CR8EB	7784	04	CR8EIX	4218
450	2	RXV/SXV	4.5	07-		0,70	CR8EKB	4374	-	CR8EIX	4218
500	1		Atlantic	02-04		0,70	CR7EKB	4455	-	CR7EIX	7385
500	1		Atlantic Sprint	02-08		0,80	CR7EKB	4455	-	CR7EIX	7385
500	1		Scarabeo	02-		0,70	CR7EKB	4455	-	CR7EIX	7385
500	1		Scarabeo ABS	04-06		0,70	CR7EKB	4455	-	CR7EIX	7385
550	2	RXV/SXV	5.5	06-08		0,70	CR8EB	7784	04	CR8EIX	4218
550	2	RXV/SXV	5.5	09-		0,70	CR8EKB	4374	-	CR8EIX	4218
600	1		Pegaso	90-		0,60	D8EA	2120	11	DR8EIX	6681
650	1		Moto 6.5	95-02		0,60	DR8EA	7162	11	DR8EIX	6681
650	1		Pegaso	92-00		0,60	DR8EA	7162	11	DR8EIX	6681
650	1		Pegaso i.e.	01-04		0,60	DR8EB	4855	-	DR8EIX	6681
650	1		Pegaso ie Factory	07-09		0,60	CR7E	4578	12	CR7EIX	7385
650	1		Pegaso ie Strada	05-		0,60	CR7E	4578	12	CR7EIX	7385
650	1		Pegaso ie Trail	06-09		0,60	CR7E	4578	12	CR7EIX	7385
750	2	SL	Shiver	07-		0,70	CR7EKB	4455	-	CR7EIX	7385

CYL.	Nb Cyl.	TYPE	MODÈLE		INFO			N° STOCK	N° BLISTER		N° STOCK IX
750	2	SMV	Dorsoduro	08-		0,70	CR7EKB	4455	-	CR7EIX	7385
750	2		Dorsoduro Factory	07-		0,70	CR7EKB	4455	-	CR7EIX	7385
850	2	NA	Mana	08-		0,60	CR7EKB	4455	-	CR7EIX	7385
850	2		Mana GT ABS	09-	2 Bougies par cylindre	0,80	CR7EKB	4455	-	CR7EIX	7385
850	2	SRV		12-		0,80	CR7EKB	4455	-	CR7EIX	7385
1000	4		Tuono 1000	02-		0,70	DCPR9E	2641	-	DCPR9EIX	2316
1000	2		Tuono 1000 R	05-		0,60	DCPR9E	2641	-	DCPR9EIX	2316
1000	2		Tuono Factory, Tuono R Factory	06-		0,60	DCPR9E	2641	-	DCPR9EIX	2316
1000	2	ETV	Caponord	01-08		0,60	DCPR9E	2641	-	DCPR9EIX	2316
1000	2	RST	Futura	01-03		0,60	DCPR9E	2641	-	DCPR9EIX	2316
1000	2	RSV	Mille	98-00		0,60	DCPR8E	4339	-	DCPR8EIX	6546
1000	2	RSV	Mille	01-03		0,60	DCPR9E	2641	-	DCPR9EIX	2316
1000	2	RSV	Mille Factory	04-05		0,60	DCPR9E	2641	-	DCPR9EIX	2316
1000	2	RSV	Mille R	99-01		0,60	DCPR8E	4339	-	DCPR8EIX	6546
1000	2	RSV	Mille R	02-05		0,60	DCPR9E	2641	-	DCPR9EIX	2316
1000	2	RSV	Mille SP	00-		1,10	R0045J-10	7400	-	-	-
1000	2	RSV	Mille Tuono, Mille Tuono R	02-03		0,60	DCPR9E	2641	-	DCPR9EIX	2316
1000	2	RSV	Mille Tuono Fighter, Mille Tuono Racing	03-		0,60	DCPR9E	2641	-	DCPR9EIX	2316
1000	2	RSV	SP	99-00		1,10	R0045J-10	7400	-	-	-
1000	2	RSV	Tuono R	02-		0,60	DCPR9E	2641	-	DCPR9EIX	2316
1000	2	RSV	Tunono V4, Tunono V4R	11-		0,70	CR9EKB	2305	-	CR9EIX	3521
1000	2	RSV	R, R-Factory, R-NERA	04-		0,60	DCPR9E	2641	-	DCPR9EIX	2316
1000	4	RSV4	Factory	09-		0,70	CR9EB	6955	06	CR9EIX	3521
1000	4	RSV4	Factory SPRC SE	10-		0,70	CR9EB	6955	06	CR9EIX	3521
1000	4	RSV4	R, R-Factory	09-		0,70	CR9EB	6955	06	CR9EIX	3521
1000	2	SL	Falco	99-04		0,60	DCPR9E	2641	-	DCPR9EIX	2316
1200	2		Dorsoduro	10-		0,70	CR9EKB	2305	-	CR9EIX	3521
1200	2		Dorsoduro	11-		0,70	CR8EKB	4374	-	CR8EIX	4218





Bougies d'allumage







ARCTIC CAT - Quad

-	1		2x4 (97A2A), 4x4 (97A4A)	97-97		0,70	CR8E	1275	04	CR8EIX	4218
50	1	DVX	DVX	06-08		0,70	CR7HSA	4549	07	CR7HIX	7544
50	1		Utility	06-08		0,70	CR7HSA	4549	07	CR7HIX	7544
50	1		Y-6 Youth	04-05		0,70	BPR7HS	6422	14	BPR7HIX	5944
50	1		Youth	06-		0,70	CR7HSA	4549	07	CR7HIX	7544
90	1	DVX	DVX	06-14		0,70	CR7HSA	4549	07	CR7HIX	7544
90	1		Utility	06-14		0,70	CR7HSA	4549	07	CR7HIX	7544
90	1		Y-12 Youth	03		0,70	BPR7HS	6422	14	BPR7HIX	5944
90	1		Y-12 Youth	05		0,70	CR6HSA	2983	-	CR6HIX	7274
90	1		Y-12 Youth 2 temps	04		0,70	BPR7HS	6422	14	BPR7HIX	5944
90	1		Y-12 Youth 4 temps	04		0,70	CR6HSA	2983	-	CR6HIX	7274
90	1		Youth	06-		0,70	CR7HSA	4549	07	CR7HIX	7544
150	1		Utility 2x4 Auto	09		0,60	DR8EA	7162	11	DR8EIX	6681
150	1		Utility 2x4 Auto	10-14		0,60	D8EA	2120	11	DR8EIX	6681
250	1		2x4	99		0,70	DR7EA	7839	-	DR7EIX	5686
250	1		2x4	00-05		0,70	DR7EA	7839	-	DR7EIX	5686
250			4x4	01-05		0,70	DR7EA	7839	-	DR7EIX	5686
250	1	DVX	DVX	06-08		0,90	DPR7EA-9	5129	13	DPR7EIX-9	7803
250	1		Utility	06-09		0,90	DPR7EA-9	5129	13	DPR7EIX-9	7803
300	1		2x4	98-03		0,70	DR7EA	7839	-	DR7EIX	5686
300	1		4x4	98-05		0,70	DR7EA	7839	-	DR7EIX	5686
300	1	DVX	DVX 2x4	10-14		0,90	DPR7EA-9	5129	13	DPR7EIX-9	7803
300	1	DVX	DVX Sport Auto	09		0,90	DPR7EA-9	5129	13	DPR7EIX-9	7803
300	1		Utility 2x4	10-14		0,90	DPR7EA-9	5129	13	DPR7EIX-9	7803
350	1		CR	11-12		0,70	CR8E	1275	04	CR8EIX	4218
366	1		4x4 Auto	08-10		0,70	CR8E	1275	04	CR8EIX	4218
366	1		4x4 Auto SE	11		0,70	CR8E	1275	04	CR8EIX	4218
375	1		2x4 Auto	02		0,70	CR7E	4578	12	CR7EIX	7385
375			4x2 & 4x4	01-		0,70	CR7E	4578	12	CR7EIX	7385
375	1		4x4 Auto	02		0,70	CR7E	4578	12	CR7EIX	7385
400	1		2x4	98-01		0,70	CR8E	1275	04	CR8EIX	4218
400			4x2 & 4x4	98-		0,70	CR6E	6965	-	-	-
400	1		4x4	98-98		0,70	CR8E	1275	04	CR8EIX	4218
400	1		4x4	99-01		0,70	CR6E	6965	-	-	-
400	1		4x4 Auto / Manual	03-04		0,70	CR7E	4578	12	CR7EIX	7385
400	1		4x4 Auto CR	13-14		0,70	CR8E	1275	04	CR8EIX	4218
400	1		EFT 2x4, EFT 4x4	14		0,70	CR8E	1275	04	CR8EIX	4218
400			i 4x2 & 4x4	98-		0,70	CR8E	1275	04	CR8EIX	4218
400			i 4x2 & 4x4	04-		0,70	CR7E	4578	12	CR7EIX	7385
400	1		DVX	04-08		0,70	CR7E	4578	12	CR7EIX	7385
400	1		FIS 2x4 Auto / Manual	03-04		0,70	CR7E	4578	12	CR7EIX	7385
400	1		FIS 2x4 Manual, FIS 4x4 Manual	02		0,70	CR6E	6965	-	-	-
400	1		FIS 4x4 Auto, FIS 4x4 Manual	03-08		0,70	CR7E	4578	12	CR7EIX	7385
400	1		Manual	02		0,70	CR6E	6965	-	-	-

ARCTIC CAT - Quad

CYL.	Nb Cyl.	TYPE	MODÈLE		INFO			N° STOCK	N° BLISTER		N° STOCK IX
400	1		TBX 4x4 Auto	04-06		0,70	CR7E	4578	12	CR7EIX	7385
400	1	TRV	TRV 4x4 Auto	06-08		0,70	CR7E	4578	12	CR7EIX	7385
400	1	TRV	TRV 4x4 Auto	09-13		0,70	CR8E	1275	04	CR8EIX	4218
400	1	TRV	TRV 400	14		0,70	CR8E	1275	04	CR8EIX	4218
400	1		VP 4x4 Auto & Manual	05-06		0,70	CR7E	4578	12	CR7EIX	7385
425	1		4x4 CR	12		0,70	CR7E	4578	12	CR7EIX	7385
425	1		4x4 EFI CR	11		0,70	CR7E	4578	12	CR7EIX	7385
450	1		4x4	12-14		0,70	CR7E	4578	12	CR7EIX	7385
450	1		4x4 EFI	10		0,70	CR7E	4578	12	CR7EIX	7385
450	1		4x4 EFI	11		0,70	CR8E	1275	04	CR8EIX	4218
450	1		EFT	14		0,70	CR7E	4578	12	CR7EIX	7385
450	1		CR	13		0,70	CR7E	4578	12	CR7EIX	7385
450	1		GT, TRV	12		0,70	CR7E	4578	12	CR7EIX	7385
450	1		TRV EFI	10		0,70	CR7E	4578	12	CR7EIX	7385
450	1		TRV GT	12		0,70	CR7E	4578	12	CR7EIX	7385
450	1	XC	XC EFI	11-14		0,70	CR7E	4578	12	CR7EIX	7385
454	1		2x4, 4x4	98-98		0,70	CR8E	1275	04	CR8EIX	4218
454	1		Bearcat 4x4	96-96		0,70	CR8E	1275	04	CR8EIX	4218
500	1		4x4	98-98		0,70	CR7E	4578	12	CR7EIX	7385
500	1		4x4	99-00		0,70	CR6E	6965	-	-	-
500	1		4x4, 4x4 XT	13-14		0,70	CR7E	4578	12	CR7EIX	7385
500	1		4x4 Auto, 4x4 Manual	09		0,70	CR6E	6965	-	-	-
500	1		Auto	00-02		0,70	CR6E	6965	-	-	-
500	1		FIS Auto / Manual	02-08		0,70	CR6E	6965	-	-	-
500			4x4 Auto	00-02		0,70	CR6E	6965	-	-	-
500	1		Manual	01-02		0,70	CR6E	6965	-	-	-
500			TBX Auto 4x4	02-06		0,70	CR6E	6965	-	-	-
500			TRV 4X4	13-14		0,70	CR7E	4578	12	CR7EIX	7385
500			TRV Auto	03-08		0,70	CR6E	6965	-	-	-
550	1		4x4	12-14		0,70	CPR8E	7411	-	-	-
550	1		550 EFT	14		0,70	CPR8E	7411	-	-	-
550	1		GT	12		0,70	CPR8E	7411	-	-	-
550	1		H1 4x4 Auto EFI	09-11		0,70	CPR8E	7411	-	-	-
550	1		H1 550s EFI	10-11		0,70	CPR8E	7411	-	-	-
550	1		H1 550s TRV EFI, H1 TRV EFI	11		0,70	CPR8E	7411	-	-	-
550	1		LTD	12-14		0,70	CPR8E	7411	-	-	-
550	1	TRV	TRV	09-10		0,70	CPR8E	7411	-	-	-
550	1	TRV	TRV 550s EFI	10		0,70	CPR8E	7411	-	-	-
550	1	TRV	TRV 550s EFI GT	11		0,70	CPR8E	7411	-	-	-
550	1	TRV	TRV Cruiser	12		0,70	CPR8E	7411	-	-	-
550	1	TRV	TRV GT	12		0,70	CPR8E	7411	-	-	-
550	1	TRV	TRV LTD, TRV XT	13-15		0,70	CPR8E	7411	-	-	-
550	1	TRV	TRV XT EFT	14-15		0,70	CPR8E	7411	-	-	-
550	1		XT	13-14		0,70	CPR8E	7411	-	-	-
550	1		XT EFT	14		0,70	CPR8E	7411	-	-	-
650			4x4	12		0,70	CPR8E	7411	-	-	-
650			4x4 Auto, 4x4 Auto Mud Pro	10		0,70	CPR8E	7411	-	-	-
650	2		FIS 4x4 V-2	04-05		0,70	CR7E	4578	12	CR7EIX	7385
650	2		FIS 4x4 V-Twin Auto	06		0,70	CR7E	4578	12	CR7EIX	7385
650			H1 4x4	05-06		0,70	CPR8E	7411	-	-	-
650	1		H1 4x4	10-11		0,60	CPR8E	7411	-	-	-
650			H1 FIS 4x4 Auto	07-08		0,70	CPR8E	7411	-	-	-
650			H1 TBX 4x4 Auto, H1 TRV 4x4 Auto	07		0,70	CPR8E	7411	-	-	-
650			H1 TRV 4x4 Auto	08		0,70	CPR8E	7411	-	-	-
650	1		H1 Mud Pro 4x4	11		0,60	CPR8E	7411	-	-	-
650	1	TBX	TBX	09		0,70	CPR8E	7411	-	-	-
650	1	TRV	TRV	09		0,70	CPR8E	7411	-	-	-
700	1		4x4	12-14		0,70	CPR8E	7411	-	-	-
700	1		EFT	14		0,70	CPR8E	7411	-	-	-
700			FIS 4x4 Auto	06-07		0,70	CR6E	6965	-	-	-
700			FIS 4x4 Auto EFI	08		0,70	CR6E	6965	-	-	-
700			GT	12-13		0,70	CPR8E	7411	-	-	-
700			H1 700s EFI	10-11		0,70	CPR8E	7411	-	-	-
700			H1 700s EFI TBX	11		0,70	CPR8E	7411	-	-	-
700			H1 700s EFI TRV	10-11		0,70	CPR8E	7411	-	-	-
700			H1 EFI 4x4 Auto, H1 EFI 4x4 Auto Mud Pro	09-11		0,70	CPR8E	7411	-	-	-
700	1		H1 EFI 4x4 TBX	10		0,60	CPR8E	7411	-	-	-
700			H1 FIS 4x4 Auto FIE	08		0,70	CPR8E	7411	-	-	-
700	1		LTD	12-14		0,60	CPR8E	7411	-	-	-
700	1	Mud Pro	Mud Pro	12-13		0,60	CPR8E	7411	-	-	-
700	1	Mud Pro	Mud Pro LTD	12-14		0,60	CPR8E	7411	-	-	-
700	1	TBX	TBX	13-14		0,60	CPR8E	7411	-	-	-
700	1	TBX	TBX GT	12		0,60	CPR8E	7411	-	-	-
700	1	TBX	TBX 700 T3S	14		0,60	CPR8E	7411	-	-	-
700	1	TRV	TRV	10-11		0,60	CPR8E	7411	-	-	-
700	1	TRV	TRV 4x4 Auto EFI, TRV 4x4 Auto LE	08		0,70	CR6E	6965	-	-	-





CYL.	Nb Cyl.	TYPE	MODÈLE		INFO			N° STOCK	N° BLISTER		N° STOCK IX
700	1	TRV	TRV 700s Cruiser	11		0,60	CPR8E	7411	-	-	-
700	1	TRV	TRV Cruiser	09-12		0,60	CPR8E	7411	-	-	-
700	1	TRV	TRV GT	12		0,60	CPR8E	7411	-	-	-
700	1	TRV	TRV LTD, TRV XT	13-15		0,60	CPR8E	7411	-	-	-
700	1	TRV	TRV XT EFT	14-15		0,60	CPR8E	7411	-	-	-
700	1		XT	13-14		0,60	CPR8E	7411	-	-	-
700	1		XT EFT	14		0,60	CPR8E	7411	-	-	-
1000	2		4X4 Auto Mud Pro	10		0,70	CPR8E	7411	-	-	-
1000	2		GT	12		0,60	CPR8E	7411	-	-	-
1000	2		H2 1000s EFI, H2 EFI Mud Pro	11		0,60	CPR8E	7411	-	-	-
1000	2	Mud Pro	Mud Pro	13		0,60	CPR8E	7411	-	-	-
1000	2	Mud Pro	Mud Pro LTD	12-14		0,60	CPR8E	7411	-	-	-
1000	2	TRV	TRV	09-10		0,60	CPR8E	7411	-	-	-
1000	2	TRV	TRV 1000s Cruiser	11		0,60	CPR8E	7411	-	-	-
1000	2	TRV	TRV Cruiser	09-12		0,60	CPR8E	7411	-	-	-
1000	2	TRV	TRV GT	12		0,60	CPR8E	7411	-	-	-
1000	2	TRV	TRV LTD	13-14		0,60	CPR8E	7411	-	-	-
1000	2	TRV	TRV 1000 XT EFT	14		0,60	CPR8E	7411	-	-	-
1000	2		Thundercat 4x4 Auto	08		0,60	CPR8E	7411	-	-	-
1000	2		Thundercat 4x4 Auto FIS EFI	09		0,60	CPR8E	7411	-	-	-
1000	2		Thundercat 4x4 EFI	10		0,60	CPR8E	7411	-	-	-
1000	2		XT	13-14		0,60	CPR8E	7411	-	-	-
1000	2		XT EFT	14		0,60	CPR8E	7411	-	-	-







ARCTIC CAT - Motoneige

60	1		Kitty Cat 60	92-99		0,70	BR6HS	3922	09	BR6HIX	3419
120	1	AC	AC 120 SnoPro (4 Temps)	07-09		0,90	BPR6ES	7822	-	BPR6EIX	6637
120	1	AC	AC 120 SnoPro (4 Temps)	10-13		0,80	BPR4ES	7222	-	-	-
120	1	F	F 120	06		0,90	BPR6ES	7822	-	BPR6EIX	6637
120	1	Z	Z 120	00-01		0,90	BPR6ES	7822	-	BPR6EIX	6637
120	1	Z	Z 120 Sno-Pro	01		0,90	BPR6ES	7822	-	BPR6EIX	6637
120	1	ZR	ZR 120	02-05		0,90	BPR6ES	7822	-	BPR6EIX	6637
120	1	ZR	ZR 120 (4 Temps)	14-15		0,80	BPR4ES	7222	-	-	-
340	2		Bearcat 340	95-97		0,70	BR9ES	5722	02	BR9EIX	3981
340	2		Bearcat 340	98-00		0,70	BR9EYA	7548	-	BR9EIX	3981
340	2	JAG	JAG 340, JAG 340 Deluxe	97		0,70	BR9ES	5722	02	BR9EIX	3981
340	2		Phanter 340	98-00		0,70	BR9EYA	7548	-	BR9EIX	3981
340	2		Puma 340, Puma 340 2-up, Puma 340 Deluxe	94-97		0,70	BR9ES	5722	02	BR9EIX	3981
370	2		Phanter 370	01		0,70	BR9EYA	7548	-	BR9EIX	3981
370	2		Panther 370 (2 Temps)	07-08		0,70	BR9EYA	7548	-	BR9EIX	3981
370	2		Panther 370 R (2 Temps)	03-06		0,70	BR9EYA	7548	-	BR9EIX	3981
370	2	Z	Z 370	99-07		0,70	BR9EYA	7548	-	BR9EIX	3981
370	2	Z	Z 370 ES	00-02		0,70	BR9EYA	7548	-	BR9EIX	3981
370	2	Z	Z 370 ESR	03		0,70	BR9EYA	7548	-	BR9EIX	3981
370	2	Z	Z 370 LX	04-07		0,70	BR9EYA	7548	-	BR9EIX	3981
400		ZR	ZR 400	96		0,70	BR9ES	5722	02	BR9EIX	3981
440	2		Bearcat 440	95-97		0,70	BR9ES	5722	02	BR9EIX	3981
440	2		Bearcat 440	98		0,70	BR9EYA	7548	-	BR9EIX	3981
440	2		Bearcat 440 I, Bearcat 440 II	99-00		0,70	BR9EYA	7548	-	BR9EIX	3981
440	2		Panther 440	97		0,70	BR9ES	5722	02	BR9EIX	3981
440	2		Panther 440	98-02		0,70	BR9EYA	7548	-	BR9EIX	3981
440	2		Panther 440 Deluxe	91-96		0,70	BR9ES	5722	02	BR9EIX	3981
440	2		Panther 440 ESR	01		0,70	BR9EYA	7548	-	BR9EIX	3981
440	2		Panther 440 LC	96		0,70	BR9ES	5722	02	BR9EIX	3981
440	2		Panther 440 Mountain Cat	90		0,70	BR9ES	5722	02	BR9EIX	3981
440	2		Panther 440 Mountain Cat	91		0,70	BR9ES	5722	02	BR9EIX	3981
440	2		Panther 440 Rental	95		0,70	BR9ES	5722	02	BR9EIX	3981
440	2		Prowler Special 440	91-92		0,70	BR9ES	5722	02	BR9EIX	3981
440	2	AC	AC 440 Sno-Pro	03-06		0,70	BR9EYA	7548	-	BR9EIX	3981
440	2	AC	AC 440 Sno-Pro Modified Race Sled	05-06		0,70	BR9EYA	7548	-	BR9EIX	3981
440	2	JAG	JAG 440 / 440 Deluxe	91-96		0,70	BR9ES	5722	02	BR9EIX	3981
440	2	JAG	JAG 440 / 440 Deluxe	98-99		0,70	BR9EYA	7548	-	BR9EIX	3981
440	2	JAG	JAG 440 Liquid	96		0,70	BR9ES	5722	02	BR9EIX	3981
440	2	Z	Z 440	95-97		0,70	BR9ES	5722	02	BR9EIX	3981
440	2	Z	Z 440	98-02		0,70	BR9EYA	7548	-	BR9EIX	3981
440	2	Z	Z 440 ES	00-02		0,70	BR9EYA	7548	-	BR9EIX	3981
440	2	Z	Z 440 ESR	03		0,70	BR9EYA	7548	-	BR9EIX	3981
440	2	Z	Z 440 LX	04-06		0,70	BR9EYA	7548	-	BR9EIX	3981
440	2	Z	Z 440 Sno-Pro	00-03		0,70	BR9EYA	7548	-	BR9EIX	3981
440	2	ZL	ZL 440	96-97		0,70	BR9ES	5722	02	BR9EIX	3981
440	2	ZL	ZL 440	98-00		0,70	BR9EYA	7548	-	BR9EIX	3981
440	2	ZR	ZR 440	93-97		0,70	BR9ES	5722	02	BR9EIX	3981
440	2	ZR	ZR 440, ZR 440 Sno-Pro	98		0,70	BR9EYA	7548	-	BR9EIX	3981
440	2	ZR	ZR 440 Sno-Pro	99-02		0,70	BR9EYA	7548	-	BR9EIX	3981





CYL.	Nb Cyl.	TYPE	MODÈLE		INFO			N° STOCK	N° BLISTER		N° STOCK IX
500	2		500 Sno-Pro		10-14	0,70	BR9EYA	7548	-	BR9EIX	3981
500	2		Firecat 500, Firecat 500 Sno-Pro		03-06	0,70	BR9EYA	7548	-	BR9EIX	3981
500	2		Mountain Cat 500		01-02	0,70	BR9EYA	7548	-	BR9EIX	3981
500	2		Powder Special 500 EFI		99-00	0,70	BR9EYA	7548	-	BR9EIX	3981
500	2		Powder Special 500 EFI LE		00	0,70	BR9EYA	7548	-	BR9EIX	3981
500	2		Sabercat 500, Sabercat 500 LX		04-06	0,70	BR9EYA	7548	-	BR9EIX	3981
500	2	CF	CrossFire 500 EFI		07-09	0,70	BR9EYA	7548	-	BR9EIX	3981
500	2	F	F 5 EFI		07-09	0,70	BR9EYA	7548	-	BR9EIX	3981
500	2	F	F 5		13-14	0,70	BR9EYA	7548	-	BR9EIX	3981
500	2	F	F 5 LXR (2 Temps)		07-12	0,70	BR9EYA	7548	-	BR9EIX	3981
500	2	M	M 5		05-06	0,70	BR9EYA	7548	-	BR9EIX	3981
500	2	T	T 500		08-09	0,70	BR9EYA	7548	-	BR9EIX	3981
500	2	ZL	ZL 500		98-00	0,70	BR9EYA	7548	-	BR9EIX	3981
500	2	ZL	ZL 500		02	0,70	BR9EYA	7548	-	BR9EIX	3981
500	2	ZL	ZL 500 EFI		99-00	0,70	BR9EYA	7548	-	BR9EIX	3981
500	2	ZL	ZL 500 EFI ESR		01	0,70	BR9EYA	7548	-	BR9EIX	3981
500	2	ZR	ZR 500 (January), ZR 500 (2nd Run)		98	0,70	BR9EYA	7548	-	BR9EIX	3981
500	2	ZR	ZR 500		99-02	0,70	BR9EYA	7548	-	BR9EIX	3981
500	2	ZR	ZR 500 CC		02	0,70	BR9EYA	7548	-	BR9EIX	3981
500	2	ZR	ZR 500 EFI		99-01	0,70	BR9EYA	7548	-	BR9EIX	3981
500	2	ZR	ZR 500 EFI LE, ZR 500 LE		99	0,70	BR9EYA	7548	-	BR9EIX	3981
500	2	ZR	ZR 500 LE		02	0,70	BR9EYA	7548	-	BR9EIX	3981
550	2		Bearcat 550		95-96	0,70	BR9ES	5722	02	BR9EIX	3981
550	2		Bearcat Wide Track 550		96-97	0,70	BR9ES	5722	02	BR9EIX	3981
550	2		Bearcat Wide Track 550		98-02	0,70	BR9EYA	7548	-	BR9EIX	3981
550	2		Cougar 550		95-97	0,70	BR9ES	5722	02	BR9EIX	3981
550	2		Cougar 550, Cougar Deluxe 550		98	0,70	BR9EYA	7548	-	BR9EIX	3981
550	2		Cougar 2-Up 550		96	0,70	BR9ES	5722	02	BR9EIX	3981
550	2		Cougar Mountain Cat 550		95-97	0,70	BR9ES	5722	02	BR9EIX	3981
550	2		Cougar Mountain Cat 550		98	0,70	BR9EYA	7548	-	BR9EIX	3981
550	2		Pantera 550		93-97	0,70	BR9ES	5722	02	BR9EIX	3981
550	2		Phanter 550		98-05	0,70	BR9EYA	7548	-	BR9EIX	3981
550	2		Prowler 2-Up 550		95	0,70	BR9ES	5722	02	BR9EIX	3981
550	2	EXT	EXT 550 EFI, EXT 550 EFI Mountain Cat		93	0,70	BR9ES	5722	02	BR9EIX	3981
550	2	EXT	EXT 550 Mountain Cat		92	0,70	BR9ES	5722	02	BR9EIX	3981
550	2	ZL	ZL550		01-03	0,70	BR9EYA	7548	-	BR9EIX	3981
550	2	ZL	ZL550 ESR		00-03	0,70	BR9EYA	7548	-	BR9EIX	3981
570	2		Bearcat 570		04-14	0,70	BR9EYA	7548	-	BR9EIX	3981
570	2		Bearcat 570 XT		09-14	0,70	BR9EYA	7548	-	BR9EIX	3981
570	2		Bearcat 570 XTE		14	0,70	BR9EYA	7548	-	BR9EIX	3981
570	2		Mountain Cat 570		02-04	0,70	BR9EYA	7548	-	BR9EIX	3981
570	2		Panther 570		02-07	0,70	BR9EYA	7548	-	BR9EIX	3981
570	2		Panther 570 ESR		02-03	0,70	BR9EYA	7548	-	BR9EIX	3981
570	2		Panther 570 R		02	0,70	BR9EYA	7548	-	BR9EIX	3981
570	2	F	F 570		08-14	0,70	BR9EYA	7548	-	BR9EIX	3981
570	2	T	T 570 Touring		08-14	0,70	BR9EYA	7548	-	BR9EIX	3981
570	2	Z	Z 570		02-07	0,70	BR9EYA	7548	-	BR9EIX	3981
570	2	Z	Z 570 ESR		02-03	0,70	BR9EYA	7548	-	BR9EIX	3981
570	2	Z	Z 570 LX		04-07	0,70	BR9EYA	7548	-	BR9EIX	3981
570	2	Z	Z 570 SS		02	0,70	BR9EYA	7548	-	BR9EIX	3981
580	2	EXT	EXT 580		94-96	0,70	BR9ES	5722	02	BR9EIX	3981
580	2	EXT	EXT 580 EFI		95-97	0,70	BR9ES	5722	02	BR9EIX	3981
580	2	EXT	EXT 580 EFI		98	0,70	BR9EYA	7548	-	BR9EIX	3981
580	2	EXT	EXT 580 EFI MC Deep Lug		95	0,70	BR9ES	5722	02	BR9EIX	3981
580	2	EXT	EXT 580 EFI Deluxe		96-97	0,70	BR9ES	5722	02	BR9EIX	3981
580	2	EXT	EXT 580 EFI Deluxe		98	0,70	BR9EYA	7548	-	BR9EIX	3981
580	2	EXT	EXT 580 EFI Mountain cat / Powder Special		94-96	0,70	BR9ES	5722	02	BR9EIX	3981
580	2		Pantera 580		94-97	0,70	BR9ES	5722	02	BR9EIX	3981
580	2		Pantera 580		98	0,70	BR9EYA	7548	-	BR9EIX	3981
580	2		Pantera 580 EFI		99-01	0,70	BR9EYA	7548	-	BR9EIX	3981
580	2		Powder Special 580, Powder Special 580 EFI		97	0,70	BR9EYA	7548	-	BR9EIX	3981
580	2	ZL	ZL 580 EFI ESR		00	0,70	BR9EYA	7548	-	BR9EIX	3981
580	2	ZR	ZR 580		93-96	0,70	BR9ES	5722	02	BR9EIX	3981
580	2	ZR	ZR 580		97	0,70	BR9EYA	7548	-	BR9EIX	3981
580	2	ZR	ZR 580 EFI		95-96	0,70	BR9ES	5722	02	BR9EIX	3981
580	2	ZR	ZR 580 EFI ETT		96	0,70	BR9ES	5722	02	BR9EIX	3981
600	2		600 Sno-Pro Racer		08-09	0,70	BR9EYA	7548	-	BR9EIX	3981
600	2		600 Sno-Pro Factory Racer		10-14	0,70	BR9EYA	7548	-	BR9EIX	3981
600	2		600 Sno-Pro Cross Country Racer		11-14	0,70	BR9EYA	7548	-	BR9EIX	3981
600	2		Firecat 600		05-06	0,70	BR9EYA	7548	-	BR9EIX	3981
600	2		Firecat 600 Black Widow		05	0,70	BR9EYA	7548	-	BR9EIX	3981
600	2		Firecat 600 Early Build		04	0,70	BR9EYA	7548	-	BR9EIX	3981
600	2		Firecat 600 EXT		04-05	0,70	BR9EYA	7548	-	BR9EIX	3981
600	2		Firecat 600 Fighter / Nightfire		04	0,70	BR9EYA	7548	-	BR9EIX	3981
600	2		Firecat 600 Jocker / Retro		05	0,70	BR9EYA	7548	-	BR9EIX	3981
600	2		Firecat 600 Team Arctic		04-05	0,70	BR9EYA	7548	-	BR9EIX	3981

CYL.	Nb Cyl.	TYPE	MODÈLE		INFO			N° STOCK	N° BLISTER		N° STOCK IX
600	2	Firecat	600 Tiger	04	0,70	BR9EYA	7548	-	BR9EIX	3981	
600	2	Firecat	600 R	05-06	0,70	BR9EYA	7548	-	BR9EIX	3981	
600	2	Firecat	600 Sno-Pro	04-06	0,70	BR9EYA	7548	-	BR9EIX	3981	
600	2	Firecat	600 Sno-Pro Black Widow	05	0,70	BR9EYA	7548	-	BR9EIX	3981	
600	2	Firecat	600 Sno-Pro Fighter / Nightfire	04	0,70	BR9EYA	7548	-	BR9EIX	3981	
600	2	Firecat	600 Sno-Pro Jocker / Retro	05	0,70	BR9EYA	7548	-	BR9EIX	3981	
600	2	Firecat	600 Sno-Pro Team Arctic	04-05	0,70	BR9EYA	7548	-	BR9EIX	3981	
600	2	Firecat	600 Sno-Pro Tiger	04	0,70	BR9EYA	7548	-	BR9EIX	3981	
600	2	Mountain Cat	600 EFI	01-04	0,70	BR9EYA	7548	-	BR9EIX	3981	
600	2	Mountain Cat	600 EFI LE	01-02	0,70	BR9EYA	7548	-	BR9EIX	3981	
600	2	Mountain Cat	600 VEV	01	0,70	BR9EYA	7548	-	BR9EIX	3981	
600	2	Pantera	600	03-05	0,70	BR9EYA	7548	-	BR9EIX	3981	
600	2	Pantera	600 ESR	02	0,70	BR9EYA	7548	-	BR9EIX	3981	
600	3	Powder Extreme	600	97	0,70	BR9ES	5722	02	BR9EIX	3981	
600	3	Powder Extreme	600	98	0,70	BR9EYA	7548	-	BR9EIX	3981	
600	2	Powder Special	2K 600	00	0,70	BR9EYA	7548	-	BR9EIX	3981	
600	2	Powder Special	600	98-99	0,70	BR9EYA	7548	-	BR9EIX	3981	
600	2	Powder Special	600, Powder Special 600 LE	00	0,70	BR9EYA	7548	-	BR9EIX	3981	
600	2	Powder Special	600 EFI	98-00	0,70	BR9EYA	7548	-	BR9EIX	3981	
600	2	Sabercat	600, Sabercat 600 EXT	04-05	0,70	BR9EYA	7548	-	BR9EIX	3981	
600	2	Sabercat	600 LX	04-06	0,70	BR9EYA	7548	-	BR9EIX	3981	
600	3	Triple	Touring 600	99-01	0,70	BR9EYA	7548	-	BR9EIX	3981	
600	2	AC	AC600 Modified Sno-Pro	07	0,70	BR9EYA	7548	-	BR9EIX	3981	
600	2	CF	CrossFire 600 EFI	06-11	0,70	BR9EYA	7548	-	BR9EIX	3981	
600	2	CF	CrossFire 600 Sno-Pro	06	0,70	BR9EYA	7548	-	BR9EIX	3981	
600	3	EXT	EXT 600	97	0,70	BR9ES	5722	02	BR9EIX	3981	
600	3	EXT	EXT 600 Tour, EXT 600 Triple	98	0,70	BR9EYA	7548	-	BR9EIX	3981	
600	2	F	F6, F6 LXR	07-08	0,70	BR9EYA	7548	-	BR9EIX	3981	
600	2	F	F6 Sno-Pro	07-11	0,70	BR9EYA	7548	-	BR9EIX	3981	
600	2	M	M 6 EFI	05-11	0,70	BR9EYA	7548	-	BR9EIX	3981	
600	2	M	M6000 Sno-Pro	14	0,70	BPR9ES	7788	-	BPR9EIX	6853	
600		ZL	ZL600	99-00	0,70	BR9EYA	7548	-	BR9EIX	3981	
600			ZL600 EFI (SN -> 9915688)	99	0,70	BR9EYA	7548	-	BR9EIX	3981	
600	2	ZL	ZL600 EFI (SN 9915689->)	99-03	0,70	BR9EYA	7548	-	BR9EIX	3981	
600	2	ZL	ZL600 EFI ESR	01-03	0,70	BR9EYA	7548	-	BR9EIX	3981	
600	2	ZL	ZL600 EFI SS, ZL600 EFI SS ESR	02-03	0,70	BR9EYA	7548	-	BR9EIX	3981	
600	2	ZR	ZR 600	99-02	0,70	BR9EYA	7548	-	BR9EIX	3981	
600	2	ZR	ZR 600 2ND RUN	98	0,70	BR9EYA	7548	-	BR9EIX	3981	
600	2	ZR	ZR 600 Blair Morgan Signature Edition	00	0,70	BR9EYA	7548	-	BR9EIX	3981	
600	2	ZR	ZR 600 CC	02	0,70	BR9EYA	7548	-	BR9EIX	3981	
600	2	ZR	ZR 600 EFI, ZR 600 EFI LE	98-01	0,70	BR9EYA	7548	-	BR9EIX	3981	
600	2	ZR	ZR 600 EFI LE Reverse	00	0,70	BR9EYA	7548	-	BR9EIX	3981	
600	2	ZR	ZR 600 EFI LE XC, ZR 600 January	98	0,70	BR9EYA	7548	-	BR9EIX	3981	
600	2	ZR	ZR 600 VEV	01	0,70	BR9EYA	7548	-	BR9EIX	3981	
600	2	ZR	ZR 6000 EL Tigre Sno-Pro LTD / ES LTD	14	0,70	BPR9ES	7788	-	BPR9EIX	6853	
600	2	ZR	ZR 6000 Sno-Pro LTD ES / Sno-Pro RR	15	0,70	BPR9ES	7788	-	BPR9EIX	6853	
600	2	ZR	ZR 6000 Sno-Pro RR	14	0,70	BPR9ES	7788	-	BPR9EIX	6853	
600	2	ZR	ZR 6000 Tucker Hibbert RR	15	0,70	BPR9ES	7788	-	BPR9EIX	6853	
600	3	ZRT	ZRT 600	95-97	0,70	BR9ES	5722	02	BR9EIX	3981	
600	3	ZRT	ZRT 600	98-02	0,70	BR9EYA	7548	-	BR9EIX	3981	
600	3	ZRT	ZRT 600 LE	01	0,70	BR9EYA	7548	-	BR9EIX	3981	
660	3		Bearcat Wide Track 660	03-08	0,80	KR8AI	5477	-	-	-	
660	3		Bearcat Wide Track WT660 Turbo	06-08	0,80	KR8AI	5477	-	-	-	
660	3		Panther 660 Touring (4 Temps)	06-08	0,80	KR8AI	5477	-	-	-	
660	3		Panther 660 Trail (4 Temps)	06-07	0,80	KR8AI	5477	-	-	-	
660	3	T	T 660 Touring	02	0,80	DCPR7E	3932	-	DCPR7EIX	6046	
660	3	T	T 660 Touring	03-08	0,80	KR8AI	5477	-	-	-	
660	3	T	T 660 Turbo ST	05-06	0,80	KR8AI	5477	-	-	-	
660	3	T	T 660 Turbo ST Early Build	05	0,80	KR8AI	5477	-	-	-	
660	3	T	T 660 Turbo Touring / Turbo Trail	03-07	0,80	KR8AI	5477	-	-	-	
660	3	T	T 660 Turbo Touring LE / Turbo Trail LE	06-07	0,80	KR8AI	5477	-	-	-	
660	3	T	T 660 Trail	02	0,80	DCPR7E	3932	-	DCPR7EIX	6046	
700	2	Firecat	700	03-06	0,70	BR9EYA	7548	-	BR9EIX	3981	
700	2	Firecat	700 EXT	04-05	0,70	BR9EYA	7548	-	BR9EIX	3981	
700	2	Firecat	700 Black Widow / Jocker / Retro	05	0,70	BR9EYA	7548	-	BR9EIX	3981	
700	2	Firecat	700 Fighter / Nightfire / Tiger	04	0,70	BR9EYA	7548	-	BR9EIX	3981	
700	2	Firecat	700 Team Arctic	04-05	0,70	BR9EYA	7548	-	BR9EIX	3981	
700	2	Firecat	700 Towy Stewart Edition	06	0,70	BR9EYA	7548	-	BR9EIX	3981	
700	2	Firecat	700 R	05-06	0,70	BR9EYA	7548	-	BR9EIX	3981	
700	2	Firecat	700 Sno-Pro	03-06	0,70	BR9EYA	7548	-	BR9EIX	3981	
700	2	Firecat	700 Sno-Pro Black Widow / Jocker	05	0,70	BR9EYA	7548	-	BR9EIX	3981	
700	2	Firecat	700 Sno-Pro Fighter / Nightfire	04	0,70	BR9EYA	7548	-	BR9EIX	3981	
700	2	Firecat	700 Sno-Pro Retro	05	0,70	BR9EYA	7548	-	BR9EIX	3981	
700	2	Firecat	700 Sno Pro Team Arctic	04-05	0,70	BR9EYA	7548	-	BR9EIX	3981	
700	2	Firecat	700 Sno-Pro Tiger	04	0,70	BR9EYA	7548	-	BR9EIX	3981	
700	2	Powder Special	700, Powder Special 700 LE	99-00	0,70	BR9EYA	7548	-	BR9EIX	3981	

CYL.	Nb Cyl.	TYPE	MODÈLE		INFO			N° STOCK	N° BLISTER		N° STOCK IX
700	2		Sabercat 700	04-05		0,70	BR9EYA	7548	-	BR9EIX	3981
700	2		Sabercat 700 EXT, Sabercat 700 LX	04-06		0,70	BR9EYA	7548	-	BR9EIX	3981
700	2		Wildcat 700 / 700 Mountain Cat	91-96		0,70	BR9ES	5722	02	BR9EIX	3981
700	2		Wildcat 700 MC Deep Lug	95		0,70	BR9ES	5722	02	BR9EIX	3981
700	2		Wildcat 700 Touring	95-96		0,70	BR9ES	5722	02	BR9EIX	3981
700	2	CF	CrossFire 700	06		0,70	BR9EYA	7548	-	BR9EIX	3981
700	2	CF	CrossFire 700 West Yellowstone	06		0,70	BR9EYA	7548	-	BR9EIX	3981
700	2	CF	CrossFire 700 Early Build / Sno-Pro	06		0,70	BR9EYA	7548	-	BR9EIX	3981
700	2	M	M7	05-06		0,70	BR9EYA	7548	-	BR9EIX	3981
700	2	M	M7 CT, M7 West Yellowstone	06		0,70	BR9EYA	7548	-	BR9EIX	3981
700	2	M	M7 LE	05-06		0,70	BR9EYA	7548	-	BR9EIX	3981
700	2	M	M7 LE CT	06		0,70	BR9EYA	7548	-	BR9EIX	3981
700	2	ZL	ZL 700	00		0,70	BR9EYA	7548	-	BR9EIX	3981
700	2	ZR	ZR 700	94-95		0,70	BR9ES	5722	02	BR9EIX	3981
700	2	ZR	ZR 700	99-00		0,70	BR9EYA	7548	-	BR9EIX	3981
700	2	ZR	ZR 700 LE, ZR 700 LE Reverse	00		0,70	BR9EYA	7548	-	BR9EIX	3981
800	2		Mountain Cat 800	01-04		0,70	BR9EYA	7548	-	BR9EIX	3981
800	2		Mountain Cat 800 LE	01-02		0,70	BR9EYA	7548	-	BR9EIX	3981
800	3		Pantera 800	98-99		0,70	BR9EYA	7548	-	BR9EIX	3981
800	2		Pantera 800	03-05		0,70	BR9EYA	7548	-	BR9EIX	3981
800	2		Pantera 800 ESR	02		0,70	BR9EYA	7548	-	BR9EIX	3981
800	2	CF	CrossFire EFI 8, CrossFire 8 EFI Sno-Pro	07-11	2 Bougies par cylindre	0,70	BR9EYA	7548	-	BR9EIX	3981
800	2	CF	CrossFire 8 EFI Sno-Pro LE	09	2 Bougies par cylindre	0,70	BR9EYA	7548	-	BR9EIX	3981
800	2	CF	CrossFire 8 EFI Sno-Pro LTD	11	2 Bougies par cylindre	0,70	BR9EYA	7548	-	BR9EIX	3981
800	2	CFR	CrossFireR 8	09-11	2 Bougies par cylindre	0,70	BR9EYA	7548	-	BR9EIX	3981
800	2	CFR	CrossFireR 8 LE	09	2 Bougies par cylindre	0,70	BR9EYA	7548	-	BR9EIX	3981
800	2	F	F 8 EFI	07-10	2 Bougies par cylindre	0,70	BR9EYA	7548	-	BR9EIX	3981
800	2	F	F 8 LE	09	2 Bougies par cylindre	0,70	BR9EYA	7548	-	BR9EIX	3981
800	2	F	F 8 LXR	07-11	2 Bougies par cylindre	0,70	BR9EYA	7548	-	BR9EIX	3981
800	2	F	F 8 EFI Sno-Pro	07-10	2 Bougies par cylindre	0,70	BR9EYA	7548	-	BR9EIX	3981
800	2	F	F 8 Sno-Pro LXR LTD	11	2 Bougies par cylindre	0,70	BR9EYA	7548	-	BR9EIX	3981
800	2	F	F 8 Sno-Pro Tony Stewart Edit.	07	2 Bougies par cylindre	0,70	BR9EYA	7548	-	BR9EIX	3981
800	2	F	F 8 EXT	11	2 Bougies par cylindre	0,70	BR9EYA	7548	-	BR9EIX	3981
800	2	F	F 800 LXR / SnoPro / SnoPro LTD	12-13	2 Bougies par cylindre	0,70	BR9EYA	7548	-	BR9EIX	3981
800	2	F	F 800 SnoPro 50th Anniversary	12	2 Bougies par cylindre	0,70	BR9EYA	7548	-	BR9EIX	3981
800	2	F	F 800 SnoPro RR	13	2 Bougies par cylindre	0,70	BR9EYA	7548	-	BR9EIX	3981
800	2	F	F 800 Tucker Hibbert Race Replica	13	2 Bougies par cylindre	0,70	BR9EYA	7548	-	BR9EIX	3981
800	2	M	M 8, M 8 Sno-Pro	07-11	2 Bougies par cylindre	0,70	BR9EYA	7548	-	BR9EIX	3981
800	2	M	M 8 Sno-Pro LE	09	2 Bougies par cylindre	0,70	BR9EYA	7548	-	BR9EIX	3981
800	2	M	M 8 Sno-Pro LTD	11	2 Bougies par cylindre	0,70	BR9EYA	7548	-	BR9EIX	3981
800	2	M	M 8 HCR	09-11	2 Bougies par cylindre	0,70	BR9EYA	7548	-	BR9EIX	3981
800	2	M	M 800, M 800 Sno-Pro	12-13	2 Bougies par cylindre	0,70	BR9EYA	7548	-	BR9EIX	3981
800	2	M	M 800 Sno-Pro Anniversay	12	2 Bougies par cylindre	0,70	BR9EYA	7548	-	BR9EIX	3981
800	2	M	M 800 Sno-Pro LTD, M 800 HCR	12-13	2 Bougies par cylindre	0,70	BR9EYA	7548	-	BR9EIX	3981
800	2	M	M 8000 / Sno-Pro / Sno-Pro LTD	14	2 Bougies par cylindre	0,70	BR9EYA	7548	-	BR9EIX	3981
800	2	M	M 8000 Sno-Pro LTD ES / HCR	14	2 Bougies par cylindre	0,70	BR9EYA	7548	-	BR9EIX	3981
800	2	XF	XF 800 LXR / Sno-Pro / Sno-Pro High Country	12-13	2 Bougies par cylindre	0,70	BR9EYA	7548	-	BR9EIX	3981
800	2	XF	XF 800 Sno-Pro 50th Anniversary	12	2 Bougies par cylindre	0,70	BR9EYA	7548	-	BR9EIX	3981
800	2	XF	XF 800 Sno-Pro High Country LTD	13	2 Bougies par cylindre	0,70	BR9EYA	7548	-	BR9EIX	3981
800	2	XF	XF 800 Sno-Pro LTD	12-13	2 Bougies par cylindre	0,70	BR9EYA	7548	-	BR9EIX	3981
800	2	XF	XF 800 CrossTour	13	2 Bougies par cylindre	0,70	BR9EYA	7548	-	BR9EIX	3981
800	2	XF	XF 8000 LXR / Sno-Pro / Sno-Pro LTD	14-15	2 Bougies par cylindre	0,70	BR9EYA	7548	-	BR9EIX	3981
800	2	XF	XF 8000 Cross Country LTD	15	2 Bougies par cylindre	0,70	BR9EYA	7548	-	BR9EIX	3981
800	2	XF	XF 8000 Cross Country Sno-Pro	14-15	2 Bougies par cylindre	0,70	BR9EYA	7548	-	BR9EIX	3981
800	2	XF	XF 8000 High Country LTD	15	2 Bougies par cylindre	0,70	BR9EYA	7548	-	BR9EIX	3981
800	2	XF	XF 8000 High Country Sno-Pro	14-15	2 Bougies par cylindre	0,70	BR9EYA	7548	-	BR9EIX	3981
800	2	XF	XF 8000 High Country Sno-Pro LTD ES	14	2 Bougies par cylindre	0,70	BR9EYA	7548	-	BR9EIX	3981
800	2	XF	XF 8000 CrossTour	14-15	2 Bougies par cylindre	0,70	BR9EYA	7548	-	BR9EIX	3981
800	2	ZL	ZL 800 ESR	01-03		0,70	BR9EYA	7548	-	BR9EIX	3981
800	2	ZL	ZL 800 ESR Illusion	01		0,70	BR9EYA	7548	-	BR9EIX	3981
800	2	ZL	ZL 800 SS	02-03		0,70	BR9EYA	7548	-	BR9EIX	3981
800	2	ZR	ZR 800	01-03		0,70	BR9EYA	7548	-	BR9EIX	3981
800	2	ZR	ZR 800 CC	02		0,70	BR9EYA	7548	-	BR9EIX	3981
800	2	ZR	ZR 800 LE	01		0,70	BR9EYA	7548	-	BR9EIX	3981
800	2	ZR	ZR 800 Sno-Pro	03		0,70	BR9EYA	7548	-	BR9EIX	3981
800	2	ZR	ZR 8000 LXR / Sno-Pro	14-15	2 Bougies par cylindre	0,70	BR9EYA	7548	-	BR9EIX	3981
800	2	ZR	ZR 8000 Sno-Pro LTD	15	2 Bougies par cylindre	0,70	BR9EYA	7548	-	BR9EIX	3981
800	2	ZR	ZR 8000 Sno-Pro LTD ES / Sno-Pro RR	14-15	2 Bougies par cylindre	0,70	BR9EYA	7548	-	BR9EIX	3981
800	2	ZR	ZR 8000 Sno-Pro LTD RR NE OS	14	2 Bougies par cylindre	0,70	BR9EYA	7548	-	BR9EIX	3981
800	3	ZRT	ZRT 800	95-97		0,70	BR9ES	5722	02	BR9EIX	3981
800	3	ZRT	ZRT 800	98-01		0,70	BR9EYA	7548	-	BR9EIX	3981
800	3	ZRT	ZRT 800 LE	01		0,70	BR9EYA	7548	-	BR9EIX	3981
900	2		King Cat 900	04-06		0,70	BR9EYA	7548	-	BR9EIX	3981
900	2		King Cat 900 Early Build	05		0,70	BR9EYA	7548	-	BR9EIX	3981
900	2		Mountain Cat 900	03-04		0,70	BR9EYA	7548	-	BR9EIX	3981
900	2		Mountain Cat 900 1M / 900 Early Build	03		0,70	BR9EYA	7548	-	BR9EIX	3981

CYL.	Nb Cyl.	TYPE	MODÈLE		INFO			N° STOCK	N° BLISTER		N° STOCK IX	
900	3		Thundercat 900		93-97		0,70	BR9ES	5722	02	BR9EIX	3981
900	3		Thundercat 900 MC		97		0,70	BR9ES	5722	02	BR9EIX	3981
900	3		Thundercat 900 MC Deep Lug		95		0,70	BR9ES	5722	02	BR9EIX	3981
900	3		Thundercat 900 Mountain Cat		94-96		0,70	BR9ES	5722	02	BR9EIX	3981
900	3		Thundercat 900 Mountain Cat W		94		0,70	BR9ES	5722	02	BR9EIX	3981
900	2	ZR	ZR 900, ZR 900 Sno-Pro		03-06		0,70	BR9EYA	7548	-	BR9EIX	3981
900	2	ZR	ZR 900 Early Build		03		0,70	BR9EYA	7548	-	BR9EIX	3981
1000	2		Bearcat Z1 XT		09-14		0,90	MR8AI9	7692	-	-	-
1000	2		Bearcat Z1 XT LTD		11-14		0,90	MR8AI9	7692	-	-	-
1000	2		Bearcat Z1 XT GS		12-14		0,90	MR8AI9	7692	-	-	-
1000	3		Mountain Cat 1000		01-02		0,70	BR9EYA	7548	-	BR9EIX	3981
1000	3		Pantera 1000		00-01		0,70	BR9EYA	7548	-	BR9EIX	3981
1000	3		Thundercat 1000		98-02		0,70	BR9EYA	7548	-	BR9EIX	3981
1000	3		Thundercat 1000 MC		98-00		0,70	BR9EYA	7548	-	BR9EIX	3981
1000	3		Thundercat 1000 THC		00		0,70	BR9EYA	7548	-	BR9EIX	3981
1000	2	CF	CrossFire 1000 EFI / EFI Sno-Pro		07-09	2 Bougies par cylindre	0,70	BR9EYA	7548	-	BR9EIX	3981
1000	2	CF	CrossFire 1000 EFI Sno-Pro Nitefire		09	2 Bougies par cylindre	0,70	BR9EYA	7548	-	BR9EIX	3981
1000	2	CFR	CrossFireR 1000		09-11	2 Bougies par cylindre	0,70	BR9EYA	7548	-	BR9EIX	3981
1000	2	CFR	CrossFireR 1000 LE		09	2 Bougies par cylindre	0,70	BR9EYA	7548	-	BR9EIX	3981
1000	2	F	F1000 EFI / EFI LXR		07-08	2 Bougies par cylindre	0,70	BR9EYA	7548	-	BR9EIX	3981
1000	2	F	F1000 EFI Sno-Pro		07-09	2 Bougies par cylindre	0,70	BR9EYA	7548	-	BR9EIX	3981
1000	2	M	M1000		07-09	2 Bougies par cylindre	0,70	BR9EYA	7548	-	BR9EIX	3981
1000	2	M	M1000 Sno-Pro		07-11	2 Bougies par cylindre	0,70	BR9EYA	7548	-	BR9EIX	3981
1000	2	M	M1000 Sno-Pro LE		09	2 Bougies par cylindre	0,70	BR9EYA	7548	-	BR9EIX	3981
1050	3	XF	XF7000 LXR		14		0,80	CR9E	6263	06	CR9EIX	3521
1050	3	XF	XF7000 Sno-Pro / Sno-Pro LTD		14		0,80	CR9E	6263	06	CR9EIX	3521
1050	3	XF	XF7000 Sno-Pro Cross Country		14		0,80	CR9E	6263	06	CR9EIX	3521
1050	3	XF	XF7000 CrossTour / CrossTour Sno-Pro		14		0,80	CR9E	6263	06	CR9EIX	3521
1050	3	ZR	ZR7000 LXR, ZR7000 Sno-Pro		14-15		0,80	CR9E	6263	06	CR9EIX	3521
1050	3	ZR	ZR7000 Sno-Pro LTD / LTD El Tigre		15		0,80	CR9E	6263	06	CR9EIX	3521
1050	3	ZR	ZR7000 Sno-Pro RR / RR Early Build		15		0,80	CR9E	6263	06	CR9EIX	3521
1100	2	F	F1100 LXR / Turbo LXR / Sno-Pro		12-13		0,90	MR8AI9	7692	-	-	-
1100	2	F	F1100 SnoPro 50 Anniversary		12		0,90	MR8AI9	7692	-	-	-
1100	2	F	F1100 SnoPro LTD, F1100 Turbo SnoPro		12-13		0,90	MR8AI9	7692	-	-	-
1100	2	F	F1100 Turbo SnoPro 50 Anniversary		12		0,90	MR8AI9	7692	-	-	-
1100	2	F	F1100 Turbo SnoPro LTD		12-13		0,90	MR8AI9	7692	-	-	-
1100	2	F	F1100 Turbo SnoPro RR		13		0,90	MR8AI9	7692	-	-	-
1100	2	M	M1100, M1100 Turbo, M1100 Sno-Pro		12-13		0,90	MR8AI9	7692	-	-	-
1100	2	M	M1100 Sno-Pro 50th Anniversary		12		0,90	MR8AI9	7692	-	-	-
1100	2	M	M1100 Sno-Pro LTD, M1100 Turbo Sno-Pro		12-13		0,90	MR8AI9	7692	-	-	-
1100	2	M	M1100 Turbo Sno-Pro 50th Anniversary		12		0,90	MR8AI9	7692	-	-	-
1100	2	M	M1100 Turbo Sno-Pro LTD		12-13		0,90	MR8AI9	7692	-	-	-
1100	2	M	M1100 Turbo High Country		12-13		0,90	MR8AI9	7692	-	-	-
1100	2	M	M9000 Turbo, M9000 Sno-Pro Turbo		14		0,90	MR8AI9	7692	-	-	-
1100	2	M	M9000 Sno-Pro LTD Turbo, M9000 HCR Turbo		14		0,90	MR8AI9	7692	-	-	-
1100	2	T	TZ1 Park Version		09		0,90	MR8AI9	7692	-	-	-
1100	2	T	TZ1 Touring / Touring LXR		08-14		0,90	MR8AI9	7692	-	-	-
1100	2	T	TZ1 Turbo LXR		09-14		0,90	MR8AI9	7692	-	-	-
1100	2	T	TZ1 Turbo LXR LE		09-10		0,90	MR8AI9	7692	-	-	-
1100	2	XF	XF1100 LXR, XF1100 Sno-Pro / SnoPro LTD		12-13		0,90	MR8AI9	7692	-	-	-
1100	2	XF	XF1100 SnoPro 50th Anniversary		12		0,90	MR8AI9	7692	-	-	-
1100	2	XF	XF1100 Turbo LXR / Turbo SnoPro		12-13		0,90	MR8AI9	7692	-	-	-
1100	2	XF	XF1100 Turbo Sno-Pro 50th Anniversary		12		0,90	MR8AI9	7692	-	-	-
1100	2	XF	XF1100 Turbo SnoPro LTD / SnoPro HiCountry		12-13		0,90	MR8AI9	7692	-	-	-
1100	2	XF	XF1100 Turbo SnoPro HiCountry LTD		13		0,90	MR8AI9	7692	-	-	-
1100	2	XF	XF1100 CrossTour, XF1100 Turbo CrossTour		13		0,90	MR8AI9	7692	-	-	-
1100	2	XF	XF 9000 LXR, XF 9000 Sno-Pro / Sno-Pro LTD		14		0,90	MR8AI9	7692	-	-	-
1100	2	XF	XF 9000 Sno-Pro LTD 137 Early Build		15		0,90	MR8AI9	7692	-	-	-
1100	2	XF	XF 9000 Sno-Pro Cross Country		14		0,90	MR8AI9	7692	-	-	-
1100	2	XF	XF 9000 High Country Sno-Pro / Sno-Pro LTD		14		0,90	MR8AI9	7692	-	-	-
1100	2	XF	XF 9000 CrossTour		14		0,90	MR8AI9	7692	-	-	-
1100	2	Z	Jaguar Z1 (Mot. Suzuki - 4 Temps)		07-08		0,90	MR8AI9	7692	-	-	-
1100	2	Z	Jaguar Z1 Early Build		07		0,90	MR8AI9	7692	-	-	-
1100	2	Z	Jaguar Z1 Sno-Pro & Nitefire Sno-Pro		08		0,90	MR8AI9	7692	-	-	-
1100	2	Z	Z1 EFI		09-10		0,90	MR8AI9	7692	-	-	-
1100	2	Z	Z1 EFI LXR		10-11		0,90	MR8AI9	7692	-	-	-
1100	2	Z	Z1 Sno-Pro		11		0,90	MR8AI9	7692	-	-	-
1100	2	Z	Z1 Turbo		09-10		0,90	MR8AI9	7692	-	-	-
1100	2	Z	Z1 Turbo LE		09		0,90	MR8AI9	7692	-	-	-
1100	2	Z	Z1 Turbo LXR / Turbo Sno-Pro		09-11		0,90	MR8AI9	7692	-	-	-
1100	2	Z	Z1 Turbo Sno-Pro LE		10		0,90	MR8AI9	7692	-	-	-
1100	2	Z	Z1 Turbo Sno-Pro LTD		11		0,90	MR8AI9	7692	-	-	-
1100	2	Z	Z1 Turbo EXT		10-11		0,90	MR8AI9	7692	-	-	-
1100	2	Z	Z1 Turbo EXT LE / EXT Sno-Pro		10		0,90	MR8AI9	7692	-	-	-
1100	2	ZR	ZR 5000 LXR (4 Temps)		14		0,90	MR8AI9	7692	-	-	-
1100	2	ZR	ZR 5000 LXR Early build		15		0,90	MR8AI9	7692	-	-	-

ARCTIC CAT - Motoneige

CYL.	Nb Cyl.	TYPE	MODÈLE		INFO			N° STOCK	N° BLISTER		N° STOCK IX
1100	2	ZR	ZR 9000 EL Tigre early Build	15		0,90	MR8AI9	7692	-	-	-
1100	2	ZR	ZR 9000 Turbo LXR	14		0,90	MR8AI9	7692	-	-	-
1100	2	ZR	ZR 9000 Sno-Pro Turbo / Sno-Pro LTD Turbo	14		0,90	MR8AI9	7692	-	-	-
1100	2	ZR	ZR 9000 Sno-Pro RR Turbo	14		0,90	MR8AI9	7692	-	-	-

ARCTIC CAT - SSV

500	1	Prowler	Prowler HDX, Prowler HDX EFI 4x4 UTV	14		0,70	CR7E	4578	12	CR7EIX	7385
500	1	Prowler	Prowler HDX LTD PS EFI 4x4 UTV	14		0,70	CR7E	4578	12	CR7EIX	7385
500	1	Prowler	Prowler HDX XT	14		0,70	CR7E	4578	12	CR7EIX	7385
550	1	Prowler	Prowler 4x4 Flatbed	09		0,70	CPR8E	7411	-	-	-
550	1	Prowler	Prowler XT H1 EFI 4x4 UTV	10-11		0,70	CPR8E	7411	-	-	-
550	1	Prowler	Prowler XT EFI 4x4 UTV	12-13		0,70	CPR8E	7411	-	-	-
550	1	Prowler	Prowler XT, Prowler XT EFI 4x4 UTV	14		0,70	CPR8E	7411	-	-	-
650	1	Prowler	Prowler H1 4x4 Auto	07-08		0,70	CPR8E	7411	-	-	-
650	1	Prowler	Prowler XT 4x4 Auto	09		0,70	CPR8E	7411	-	-	-
650	1	Prowler	Prowler XT H1 4x4 Auto	06-08		0,70	CPR8E	7411	-	-	-
650	1	Prowler	Prowler HDX LTD PS EFI 4x4 UTV	14		0,70	CPR8E	7411	-	-	-
700	1	Prowler	Prowler XDX	14		0,70	CPR8E	7411	-	-	-
700	1	Prowler	Prowler XDX/XTX H1 EFI 4x4 UTV	11		0,70	CPR8E	7411	-	-	-
700	1	Prowler	Prowler XDX EFI 4x4 UTV	12		0,70	CPR8E	7411	-	-	-
700	1	Prowler	Prowler XDX EFI PS 4x4 UTV	13		0,70	CPR8E	7411	-	-	-
700	1	Prowler	Prowler XT 4x4	09		0,70	CPR8E	7411	-	-	-
700	1	Prowler	Prowler XTX EFI 4x4 UTV	12		0,70	CPR8E	7411	-	-	-
700	1	Prowler	Prowler XTX EFI PS 4x4 UTV	13		0,70	CPR8E	7411	-	-	-
700	1	Prowler	Prowler XTX, Prowler XTX PS EFI 4x4 UTV	14		0,70	CPR8E	7411	-	-	-
700	1	Prowler	Prowler XTX 4x4 / XTX LE 4x4	09		0,70	CPR8E	7411	-	-	-
700	1	Prowler	Prowler XTX H1 EFI 4x4 UTV	10		0,70	CPR8E	7411	-	-	-
700	1	Prowler	Prowler XTX H1 4x4 Auto	08		0,70	CPR8E	7411	-	-	-
700	1	Wildcat	Wildcat Sport, Wildcat Trail Cat	15		0,70	CR8EB	7784	04	CR8EIX	4218
700	1	Wildcat	Wildcat Trail	14-15		0,70	CR8EB	7784	04	CR8EIX	4218
700	1	Wildcat	Wildcat Trail XT	14-15		0,70	CR8EB	7784	04	CR8EIX	4218
1000	2	Prowler	Prowler XTZ H2 4x4	09		0,70	CPR8E	7411	-	-	-
1000	2	Prowler	Prowler XTZ H2 EFI 4x4 UTV	10		0,70	CPR8E	7411	-	-	-
1000	2	Prowler	Prowler XTZ EFI 4x4 UTV	12		0,70	CPR8E	7411	-	-	-
1000	2	Prowler	Prowler XTZ EFI PS 4x4 UTV	13		0,70	CPR8E	7411	-	-	-
1000	2	Prowler	Prowler XTZ 4x4	14		0,70	CPR8E	7411	-	-	-
1000	2	Prowler	Prowler XTZ H2 4x4 Baja	09		0,70	CPR8E	7411	-	-	-
1000	2	Prowler	Prowler XTZ H2 EFI 4x4 UTV	11		0,70	CPR8E	7411	-	-	-
1000	2	Prowler	Prowler XTZ PS EFI 4x4 UTV	14		0,70	CPR8E	7411	-	-	-
1000	2	Wildcat	Wildcat	13-15		0,70	CPR8E	7411	-	-	-
1000	2	Wildcat	Wildcat 4	13-14		0,70	CPR8E	7411	-	-	-
1000	2	Wildcat	Wildcat 4 LTD / 4 X / 4 X LTD	14		0,70	CPR8E	7411	-	-	-
1000	2	Wildcat	Wildcat GT	12-13		0,70	CPR8E	7411	-	-	-
1000	2	Wildcat	Wildcat Late Build, Wildcat LTD Late Build	13		0,70	CPR8E	7411	-	-	-
1000	2	Wildcat	Wildcat LTD	13-14		0,70	CPR8E	7411	-	-	-
1000	2	Wildcat	Wildcat X	13-15		0,70	CPR8E	7411	-	-	-
1000	2	Wildcat	Wildcat X LTD (U2014WTW1P)	14		0,70	CPR8E	7411	-	-	-

AXR - Quad

250		UT		06-		0,70	DR8EA	7162	11	DR8EIX	6681
-----	--	----	--	-----	--	------	-------	------	----	--------	------

BAJAJ

50		Bonnie 50		93-		0,50	B6HS	4510	09	BR6HIX	3419
50	1	Sprit		99-		0,50	B6HS	4510	09	BR6HIX	3419
50	1	Sunny		96-		0,50	B6HS	4510	09	BR6HIX	3419
100		KB100		93-		0,50	B8ES	2411	05	BR8EIX	5044
125	1	Chetak		96-		0,50	BP6HS	4511	-	BPR6HIX	4085
125		Vespa		93-		0,50	B6HS	4510	09	BR6HIX	3419
150		Chetak 150		01-		0,70	BPR5HS	6222	-	-	-
150	1	Classic		00-		0,60	BPR5HS	6222	-	-	-

BAROSSA - Quad

50	1	Mini		-		0,60	BPR7HS	6422	14	BPR7HIX	5944
50	1	Python		-		0,80	BPR7HS	6422	14	BPR7HIX	5944
100	1	Python		-		0,80	BPR7HS	6422	14	BPR7HIX	5944
125	1	XS T-13		07-		0,80	CR7HSA	4549	07	CR7HIX	7544
150	1	Magna		-		0,70	DR8EA	7162	11	DR8EIX	6681
170	1	Magna		-		0,70	DR8EA	7162	11	DR8EIX	6681
250	1	Magna		-		0,70	DR8EA	7162	11	DR8EIX	6681

CYL. Nb Cyl. TYPE MODÈLE



INFO



N° STOCK

N° BLISTER



N° STOCK IX



BASHAN





110	1	BS 110 GY	01-	0,60	C7HSA	4629	07	CR7HIX	7544
125	1	BS 125 GY	01-	0,60	D8EA	2120	11	DR8EIX	6681
200	1	BS 200 GY	01-	0,60	D8EA	2120	11	DR8EIX	6681
250		Vixen VX250	06-	0,70	DR8EA	7162	11	DR8EIX	6681



BENELLI

50		3G2	-	0,50	B6ES	7310	-	-	-
50	1	49X Quattro Nove, 49X Road, 49X Trek	08-	0,60	BR8HSA	5539	-	BR8HIX	7001
50	1	Al	-	0,60	B6HS	4510	09	BR6HIX	3419
50		Cross	-	0,50	B6ES	7310	-	-	-
50	1	Gentleman, Magnum 5V	-	0,50	B5ES	6410	-	-	-
50	1	LX	01-	0,60	BR8HS	4322	01	BR8HIX	7001
50	1	Magnum 3V	-	0,50	B7ES	1111	-	BR7EIX	6664
50		Motorella	-	0,50	B6ES	7310	-	-	-
50	1	Naked	-	0,60	BR8HS	4322	01	BR8HIX	7001
50	1	Pepe Cat.	01-	0,60	BR8HS	4322	01	BR8HIX	7001
50	1	Pepe Classic	10-	0,60	BR7HS	4122	03	BR7HIX	7067
50	1	Scoothy	-	0,60	B6HS	4510	09	BR6HIX	3419
50	1	Spring	-	0,50	B8ES	2411	05	BR8EIX	5044
50	1	Stilo	-	0,60	B6HS	4510	09	BR6HIX	3419
50	1	491 GT - Air Cool., LC - Sport, Racing, SBK, Army	97-	0,60	BR8ES	5422	05	BR8EIX	5044
50	1	491 LC cat. Racing & Sport	99-	0,60	BR8HS	4322	01	BR8HIX	7001
50	1	K2 Namur AC	98-	0,60	BR7HS	4122	03	BR7HIX	7067
50	1	K2 Namur LC	99-	0,60	BR8HS	4322	01	BR8HIX	7001
50	1	S	-	0,50	B6HS	4510	09	BR6HIX	3419
50	1	X Offroad, Quattronove X 50	08-	0,80	BR8HS	4322	01	BR8HIX	7001
100	1	K2	99-	0,60	BR8HS	4322	01	BR8HIX	7001
125	1		-	0,50	B6HS	4510	09	BR6HIX	3419
125	2	2C Twin	-	0,50	B7ES	1111	-	BR7EIX	6664
125	1	Adiva	01-	0,70	CR9EB	6955	06	CR9EIX	3521
125		Cross	-	0,50	B7ES	1111	-	BR7EIX	6664
125	1	Jarno	-	0,50	B8ES	2411	05	BR8EIX	5044
125	1	Macis	10-	0,60	CR8E	1275	04	CR8EIX	4218
125		Roadster	-	0,50	B7ES	1111	-	BR7EIX	6664
125	1	Scooter S	-	0,50	B7HS	5110	03	BR7HIX	7067
125	1	Velvet	01-	0,60	CR8E	1275	04	CR8EIX	4218
150	1	Adiva	01-	0,70	CR9EB	6955	06	CR9EIX	3521
150	1	Macis	10-	0,60	CR8E	1275	04	CR8EIX	4218
150	1	Velvet	01-	0,60	CR8E	1275	04	CR8EIX	4218
250	1		-	0,50	B6ES	7310	-	-	-
250	4	250 (4-cyl.)	-	0,50	C7HSA	4629	07	CR7HIX	7544
250		2C, 2CE, Sport spéciale	-	0,50	B7ES	1111	-	BR7EIX	6664
250		Adiva	-	0,80	CR8EB	7784	04	CR8EIX	4218
250	1	Caffè Nero	08-	0,90	DPR8EA-9	4929	08	DPR8EIX-9	2202
250		Super	-	0,50	B8ES	2411	05	BR8EIX	5044
250		Velvet	00-	0,60	CR8E	1275	04	CR8EIX	4218
250	1	Velvet	01-	0,60	DR8EA	7162	11	DR8EIX	6681
250	1	Velvet MY08	08-	0,90	DPR8EA-9	4929	08	DPR8EIX-9	2202
400		Dusk	05-	0,70	CR9E	6263	06	CR9EIX	3521
400		Velvet 400	03-04	0,70	CR9E	6263	06	CR9EIX	3521
500	1	LS, Quattro, 504 Sport	-	0,50	D8EA	2120	11	DR8EIX	6681
650	1	654 Sport, 4C	-	0,50	D8EA	2120	11	DR8EIX	6681
650	1	S / SV Tornado	-	0,50	B8ES	2411	05	BR8EIX	5044
750	6	Sei	-	0,50	D8EA	2120	11	DR8EIX	6681
900	3	Century Racer	10-	0,70	CR9E	6263	06	CR9EIX	3521
900		Tornado, Tornado Limited Edition	00-	0,70	CR9E	6263	06	CR9EIX	3521
900	3	Tornado LE, Tornado RS, Tornado TRE	05-	0,60	C7E	5096	12	CR7EIX	7385
900	3	Tornado Tre 903	08-	0,70	CR9E	6263	06	CR9EIX	3521
900	3	TNT 899	07-	0,70	CR9E	6263	06	CR9EIX	3521
900	3	TNT 899 Cafe Racer	09-	0,70	CR9E	6263	06	CR9EIX	3521
900		TNT 899 S-Tornado Naked Tre	08-	0,70	CR9E	6263	06	CR9EIX	3521
900	3	TNT 899 Sport	07-	0,70	CR9E	6263	06	CR9EIX	3521
900	6	VN/VT Sei	-	0,50	D8EA	2120	11	DR8EIX	6681
900		Tre-K 899	09-	0,70	CR9EB	6955	06	CR9EIX	3521
998	3	Tre-K	07-	0,70	CR9E	6263	06	CR9EIX	3521
1130	3	Century Racer	10-	0,70	CR9E	6263	06	CR9EIX	3521
1130	3	Tornado Tre 163ch	-	0,70	CR9E	6263	06	CR9EIX	3521
1130		Tornado Tre K	06-	0,70	CR9E	6263	06	CR9EIX	3521
1130		Tre K Amazonas	07-	0,70	CR9E	6263	06	CR9EIX	3521
1130	3	TNT	04-	0,70	CR9E	6263	06	CR9EIX	3521
1130	3	TNT Cafe Racer	-	0,70	CR9E	6263	06	CR9EIX	3521





Bougies d'allumage

CYL.	Nb Cyl.	TYPE	MODÈLE		INFO			N° STOCK	N° BLISTER		N° STOCK IX
1130		TNT	K	04-	0,70		CR9E	6263	06	CR9EIX	3521
1130		TNT	Titanium	06-	0,80		CR9E	6263	06	CR9EIX	3521
1130	3	TNT	R160	09-	0,70		CR9E	6263	06	CR9EIX	3521
1130	3	TNT	Sport Evo	-	0,70		CR9E	6263	06	CR9EIX	3521



BETA / BETAMOTOR

50	1		ALP	93-	0,50		B8ES	2411	05	BR8EIX	5044
50	1		Ark Air	97-	0,50		BR7HS	4122	03	BR7HIX	7067
50	1		Ark - ref. Liquide, LC serie K	97-	0,50		BR8HS	4322	01	BR8HIX	7001
50	1		Ark 2 tps - ref.air	-	0,60		BR7HS	4122	03	BR7HIX	7067
50	1		Ark 2 tps - ref.liquide	-	0,60		BR6HS	3922	09	BR6HIX	3419
50	1		Ark AC, Ark LC	09-	0,50		BR8HS	4322	01	BR8HIX	7001
50	1		Ark RR	-	0,60		BR8HS	4322	01	BR8HIX	7001
50	1		Ark Skull	09-	0,60		BR8HS	4322	01	BR8HIX	7001
50	1		Ark X Type	-	0,60		BR8HS	4322	01	BR8HIX	7001
50	1		Bad	-	0,50		B9ES	2611	02	BR9EIX	3981
50	1		Chrono, 502	95-	0,50		BR7HS	4122	03	BR7HIX	7067
50	1		Eikon	98-	0,50		BR8HS	4322	01	BR8HIX	7001
50	1		Minicross 10"x10" & 12"x15"	99-	0,50		B7HS	5110	03	BR7HIX	7067
50	1		Minitrial	95-	0,50		B7HS	5110	03	BR7HIX	7067
50	1		Quadra	95-	0,50		BR7HS	4122	03	BR7HIX	7067
50	1		R10, R12	-	0,50		B7HS	5110	03	BR7HIX	7067
50	1		Supermotard	-	0,50		B10ES	7928	-	BR10EIX	6801
50	1		Super Trial	94-	0,50		B8ES	2411	05	BR8EIX	5044
50	1		Tempo	94-	0,50		BR7HS	4122	03	BR7HIX	7067
50	1		Zero, Zero Mini	94-95	0,50		B9ES	2611	02	BR9EIX	3981
50	1		KR	-	0,50		B6ES	7310	-	-	-
50	1		MX	93-	0,50		B9ES	2611	02	BR9EIX	3981
50	1		REV	04-	0,50		B9ES	2611	02	BR9EIX	3981
50	1		RK 6-50	-	0,50		B8ES	2411	05	BR8EIX	5044
50	1		RR Enduro	97-	0,50		B9ES	2611	02	BR9EIX	3981
50	1		RR Enduro	-	0,50		BR9ES	5722	02	BR9EIX	3981
50	1		RR Enduro, Racing 50 (Euro 2)	04-	0,60		BR9ES	5722	02	BR9EIX	3981
50	1		RR Motard, Motard Track, Racing	09-	0,50		BR9ES	5722	02	BR9EIX	3981
50	1		RR Super Motard	97-	0,50		B9ES	2611	02	BR9EIX	3981
80	1		M4 4-T	-	0,80		CR9EK	4548	-	CR9EIX	3521
80	1		EVO 80, 80 Junior	08-	0,60		BR8ES	5422	05	BR8EIX	5044
80	1		REV Zero, Zero Mini	04-	0,50		B9ES	2611	02	BR9EIX	3981
107			R107-4T	-	0,70		C7HSA	4629	07	CR7HIX	7544
124	1		Dougie Lampkin Replica	-	0,50		B8ES	2411	05	BR8EIX	5044
125	1		Alp 2 Tps	98-99	0,50		BP7ES	2412	-	BPR7EIX	4055
125	1		Alp 4 Temps	00-	0,70		DR8EA	7162	11	DR8EIX	6681
125	1		Alp 4 Temps	-	0,60		CR7HSA	4549	07	CR7HIX	7544
125			E6G	-	0,50		B7HS	5110	03	BR7HIX	7067
125	1		Eikon	99-	0,90		DPR7EA-9	5129	13	DPR7EIX-9	7803
125			Enduro	-	0,50		B7HS	5110	03	BR7HIX	7067
125	1		Euro Cruiser	-	0,70		DR8EA	7162	11	DR8EIX	6681
125	1		Jonathan	00-	0,70		DR8EA	7162	11	DR8EIX	6681
125			Minicross R 125 4T	-	0,70		C7HSA	4629	07	CR7HIX	7544
125	1		REV-3	00-06	0,70		B8ES	2411	05	BR8EIX	5044
125	1		REV-3, REV-3 Trials	06-	0,50		BP7ES	2412	-	BPR7EIX	4055
125	1		Synt	94-	0,50		B8ES	2411	05	BR8EIX	5044
125	1		Techno	95-	0,50		BR8ES	5422	05	BR8EIX	5044
125	1		TR-32, TR-34, TR-35	-	0,50		B8ES	2411	05	BR8EIX	5044
125			Trial	-	0,50		B6ES	7310	-	-	-
125	1		Urban 125	08-	0,60		CR7HSA	4549	07	CR7HIX	7544
125	1		Urban 125 Spécial	-	0,60		CR7HSA	4549	07	CR7HIX	7544
125	1		Zero	94-	0,50		B8ES	2411	05	BR8EIX	5044
125	1		EVO Moteur 2 temps	08-	0,50		BR7ES	5122	-	BR7EIX	6664
125	1		R 4 Temps	-	0,60		C7HSA	4629	07	CR7HIX	7544
125	1		RE 4 Temps	06-	0,60		CR7HSA	4549	07	CR7HIX	7544
125	1		REV 3	00-	0,60		BP6ES	7811	-	BPR6EIX	6637
125	1		RR LC - Moteur Minarelli 4-T liquide	10-	0,60		CR8E	1275	04	CR8EIX	4218
125			RR Enduro, Motard	06-	0,60		CR7HSA	4549	07	CR7HIX	7544
125			RR Enduro	10-	0,60		CR8E	1275	04	CR8EIX	4218
150	1		Eikon	99-	0,90		DPR7EA-9	5129	13	DPR7EIX-9	7803
200	1		EVO Moteur 2 temps	08-	0,60		BR7ES	5122	-	BR7EIX	6664
200	1		Alp 4 Temps - Mot.Suzuki	01-	0,70		DR8EA	7162	11	DR8EIX	6681
200	1		Urban	08-	0,60		DR8EA	7162	11	DR8EIX	6681
200	1		Urban Special	09-	0,60		DR8EA	7162	11	DR8EIX	6681
200			Techno 200 Trial	-96	0,60		BR8ES	5422	05	BR8EIX	5044
200			Techno 200 Trial	96-	0,60		BP7ES	2412	-	BPR7EIX	4055
200	1		REV 3	-	0,60		BP6ES	7811	-	BPR6EIX	6637
200			REV 3 Trials	00-07	0,60		BP7ES	2412	-	BPR7EIX	4055

CYL.	Nb Cyl.	TYPE	MODÈLE		INFO			N° STOCK	N° BLISTER		N° STOCK IX
200	1	REV	3 Trials	08-		0,50	BR7ES	5122	-	BR7EIX	6664
240	1		Alp	95-		0,50	B8ES	2411	05	BR8EIX	5044
240			Trial	-		0,50	B6ES	7310	-	-	-
240	1		Super Trail	94-		0,50	B8ES	2411	05	BR8EIX	5044
240	1		TR-33	-		0,50	B6ES	7310	-	-	-
247	1		Dougie Lampkin Replica	-		0,50	BP7ES	2412	-	BPR7EIX	4055
250	1		Alp	-		0,50	B8ES	2411	05	BR8EIX	5044
250	1		Alp LC	95-		0,50	BP7ES	2412	-	BPR7EIX	4055
250	1		Eikon	99-		0,90	DPR7EA-9	5129	13	DPR7EIX-9	7803
250			Enduro	-		0,50	B7HS	5110	03	BR7HIX	7067
250	1		Techno	-		0,50	BP7ES	2412	-	BPR7EIX	4055
250	1		Techno	96-99		0,50	BR8ES	5422	05	BR8EIX	5044
250	1		Trial	-		0,50	BP7ES	2412	-	BPR7EIX	4055
250	1		TR32, Super Trail	-		0,50	B8ES	2411	05	BR8EIX	5044
250	1	EVO	Moteur 2 temps	08-		0,60	BR7ES	5122	-	BR7EIX	6664
250	1	EVO	Moteur 4 temps	08-		0,80	CR7EB	4663	12	CR7EIX	7385
250	1	REV	3	00-		0,50	BP7ES	2412	-	BPR7EIX	4055
250	1	REV	3 2T Trials	00-07		0,60	BP7ES	2412	-	BPR7EIX	4055
250	1	REV	3 2T Trials	08-		0,50	BR7ES	5122	-	BR7EIX	6664
250	1	REV	4T Trials	07-		0,60	CR7EB	4663	12	CR7EIX	7385
250	1	RR	4 Temps	-		0,80	DCPR8E	4339	-	DCPR8EIX	6546
260	1		Alp, Super Trail, TR34, TR35 Campionato, Zero	-		0,50	B8ES	2411	05	BR8EIX	5044
260	1		Synt, Zero Gara	94-		0,50	B8ES	2411	05	BR8EIX	5044
270	1		REV-3	06-		0,50	BR7ES	5122	-	BR7EIX	6664
270			Techno 270 Trial	-96		0,60	BR8ES	5422	05	BR8EIX	5044
270			Techno 270 Trial	96-		0,60	BP7ES	2412	-	BPR7EIX	4055
275	1		REV 3 270	-		0,60	BP6ES	7811	-	BPR6EIX	6637
290	1	EVO	Moteur 2 temps	-		0,50	BR7ES	5122	-	BR7EIX	6664
300	1	EVO	Moteur 4 temps	09-		0,80	CR7EB	4663	12	CR7EIX	7385
350	1		Alp M4 - Mot.Suzuki	-		0,60	CR9EK	4548	-	CR9EIX	3521
350	1		Euro	99-		0,90	DPR8EA-9	4929	08	DPR8EIX-9	2202
350	1		Jonathan, Alp 4.0 (Suzuki engine)	-		0,70	CR9EK	4548	-	CR9EIX	3521
350	1		M4T	11-		0,70	CR9EK	4548	-	CR9EIX	3521
350	1		Motard 4.0 4T	03-		0,70	CR9EK	4548	-	CR9EIX	3521
350		RR	Racing	13		0,90	LKAR8A-9	4786	-	-	-
400	1		Alp 4.0	04-		0,70	CR9EK	4548	-	CR9EIX	3521
400	1	RR	4 Temps	-		0,80	DCPR8E	4339	-	DCPR8EIX	6546
400	1	RR	4 Temps	10-		0,90	LKAR8A-9	4786	-	-	-
450	1	RR	4 Temps	-		0,80	DCPR8E	4339	-	DCPR8EIX	6546
450	1	RR	4 Temps	10-		0,90	LKAR8A-9	4786	-	-	-
500	1	RR	4 Temps	10-		0,90	LKAR8A-9	4786	-	-	-
520	1	RR	4 Temps	10-		0,90	LKAR8A-9	4786	-	-	-
525	1	RR	4 Temps	-		0,80	DCPR8E	4339	-	DCPR8EIX	6546



BIMOTA

500	2		V-Due	97-		0,70	BR8ES	5422	05	BR8EIX	5044
500	2		V-Due Evoluzione	00-		0,70	-	-	-	DR8EIX	6681
600	4	YB-9	SR, SRi	94-96		0,70	CR9E	6263	06	CR9EIX	3521
650	1	BB-1	Supermono, Biposto	96-		0,70	D8EA	2120	11	DR8EIX	6681
750	4	SB-7	(Suzuki)	94-96		0,70	CR9EK	4548	-	CR9EIX	3521
900	2	DB-2	(Ducati)	93-95		0,90	DPR8EA-9	4929	08	DPR8EIX-9	2202
900	2	DB-2	SR, Half Fairing, Full Fairing	94-		0,90	DPR8EA-9	4929	08	DPR8EIX-9	2202
900	2	DB-3	Mantra	96-		0,90	DPR8EA-9	4929	08	DPR8EIX-9	2202
900	2	DB-4		98-		0,90	DPR8EA-9	4929	08	DPR8EIX-9	2202
900	2	DB-4	Injection	00-		0,90	DCPR8E	4339	-	DCPR8EIX	6546
904	2	DB-3	Mantra (Ducati)	95-98		0,90	DPR8EA-9	4929	08	DPR8EIX-9	2202
906	2	DB-1	Tesi 1 D ES, SR	94-		0,60	-	-	-	DR9EIX	4772
992	2	DB-5		05-		0,80	DCPR8E	4339	-	DCPR8EIX	6546
992	2	DB-6	R Délinio	08-		0,80	DCPR8E	4339	-	DCPR8EIX	6546
1000	2	SB-8	R, R Spécial	-		0,70	CR9EK	4548	-	CR9EIX	3521
1000	4	YB-8	E Paioli, Evolution, E Ohlins	94-		0,70	DR8ES-L	2923	-	DR8EIX	6681
1000		YB-10	Biposto	95-		0,70	DR8EA	7162	11	DR8EIX	6681
1000	4	YB-11	Superlaggera	96-		0,70	DR8EA	7162	11	DR8EIX	6681
1078	2	DB-5/6	R,S	09-		0,80	DCPR8E	4339	-	DCPR8EIX	6546
1078	2	DB-6	R Delirio	08-		0,90	DCPR8E	4339	-	DCPR8EIX	6546
1078	2		Tesi 3 D	10-		0,80	DCPR8E	4339	-	DCPR8EIX	6546
1100	2	DB-5		05-06		0,90	DCPR8E	4339	-	DCPR8EIX	6546
1100	2	DB-6		07-		0,80	DCPR8E	4339	-	DCPR8EIX	6546
1100		DB-7		09-		0,80	MAR10A-J	4706	-	-	-
1100	4	SB-6	(Suzuki)	94-96		0,70	CR9E	6263	06	CR9EIX	3521
1100	4	SB-6	R	94-		0,70	CR9E	6263	06	CR9EIX	3521

BLANEY - Quad

CYL. Nb Cyl. TYPE MODÈLE



INFO



N° STOCK

N° BLISTER



N° STOCK IX

BLANEY - Quad



79	1	FX	70	99-	0,70	BP7HS	5111	14	BPR7HIX	5944
90	1	FX		00-	0,70	BP7HS	5111	14	BPR7HIX	5944
100	1	FX		00-	0,70	BP7HS	5111	14	BPR7HIX	5944

BLATA

40	1		Elite 13, Elite 13W	-	0,80	B9ES	2611	02	BR9EIX	3981
40	1		Elite 13S, Elite 13WR, Elite 13WRS	-	0,50	B9EGV	5827	-	-	-
49	1		Pocket bike Réplica	-	0,70	BR6HS	3922	09	BR6HIX	3419

BMW

125	1	C1	C1N Scooter	99-03	0,70	CR8EB	7784	04	CR8EIX	4218	
200	1	C1	C1N Scooter	01-03	0,70	CR8EB	7784	04	CR8EIX	4218	
450	1	G	X K16	07-10	0,70	CR9EKB	2305	-	CR9EIX	3521	
600	2	C	Sport K18, GT K19	11-	0,80	LMAR8D-J	93444	-	-	-	
650	1	F	E169 94/97	93-03	0,70	D8EA	2120	11	DR8EIX	6681	
650	1	F	CS K14 02/04	00-05	0,60	DR8EB	4855	-	DR8EIX	6681	
650	1	F	CS Scarver	01-	0,70	D8EA	2120	11	DR8EIX	6681	
650	1	F	GS R13 00	99-03	0,60	D8EA	2120	11	DR8EIX	6681	
650	1	F	GS R13 04	03-07	0,60	DR8EB	4855	-	DR8EIX	6681	
650	1	F	GS K72	06-12	0,90	DCPR8E	4339	-	DCPR8EIX	6546	
650	1	F	GS Dakar R13 00	99-03	0,70	D8EA	2120	11	DR8EIX	6681	
650	1	F	GS Dakar R13 04	03-07	0,60	DR8EB	4855	-	DR8EIX	6681	
650	2	F	GS Sertão R13	10-	0,60	DR8EB	4855	-	DR8EIX	6681	
650	1	F	ST E169 97	96-00	0,70	D8EA	2120	11	DR8EIX	6681	
650	1		BMS-C II F 650	04	2 Bougies par Cylindre	0,60	DR8EB	4855	-	DR8EIX	6681
650	1	G	GS R131 09/11	08-	0,60	DR8EB	4855	-	DR8EIX	6681	
650	1	G	Xchallenge K15, Xcountry K15 07	06-07	0,60	DR8EB	4855	-	DR8EIX	6681	
650	1	G	Xcountry K15 08	07-09	0,60	DR8EB	4855	-	DR8EIX	6681	
650	1	G	Xmoto K15	06-07	0,60	DR8EB	4855	-	DR8EIX	6681	
700	2	F	GS K70	11-	0,90	DCPR8E	4339	-	DCPR8EIX	6546	
750	3	K	75 RT K569	89-97	0,60	D7EA	7912	-	DR7EIX	5686	
750	3	K	75 S K569	85-95	0,60	D7EA	7912	-	DR7EIX	5686	
800	2	F	650 GS	08-	0,90	DCPR8E	4339	-	DCPR8EIX	6546	
800	2	F	GS K72 08	06-12	0,90	DCPR8E	4339	-	DCPR8EIX	6546	
800	2	F	GS K72 13	11	0,80	DCPR8E	4339	-	DCPR8EIX	6546	
800	2	F	GS Adventure K75	12	0,80	DCPR8E	4339	-	DCPR8EIX	6546	
800	2	F	R K73	05-	0,80	DCPR8E	4339	-	DCPR8EIX	6546	
800	2	F	R Chris Pfeiffer Replica	10-	0,80	DCPR8E	4339	-	DCPR8EIX	6546	
800	2	F	GT K71	11-	0,80	DCPR8E	4339	-	DCPR8EIX	6546	
800	2	F	S K71	04-	0,80	DCPR8E	4339	-	DCPR8EIX	6546	
800	2	F	ST K71	04-12	0,80	DCPR8E	4339	-	DCPR8EIX	6546	
850	2	R		94-95	0,80	BCPR7ET	2164	-	BCPR7EIX	5690	
850	2	R		95-99	0,80	BKR7EKC	7354	-	BKR7EIX	2667	
850	2	R	C 59C1 99	98-00	0,80	BKR7EKC	7354	-	BKR7EIX	2667	
850	2	R	GS 259E 95	96-00	0,80	BKR7EKC	7354	-	BKR7EIX	2667	
850	2	R	R 259R 94	94-02	0,80	BKR7EKC	7354	-	BKR7EIX	2667	
850	2	R	R R28 02	99-07	-	BKR7EKC	7354	-	BKR7EIX	2667	
850	2	R	RT R22 02	00-06	0,80	BKR7EKC	7354	-	BKR7EIX	2667	
900	2	R	RT K26 05 SF	05-09	0,80	DCPR8EKC	7168	-	DCPR8EIX	6546	
900	2	R	RT K26 10 SF	09-	0,80	DCPR8EKC	7168	-	DCPR8EIX	6546	
1000	4	K	100 RS 16 Soupapes	89-	0,60	DR7EA	7839	-	DR7EIX	5686	
1000	2	R	100	-	0,60	BP7ES	2412	-	BPR7EIX	4055	
1000	2	R	100 GS 47E1	86-95	0,60	BP6ES	7811	-	BPR6EIX	6637	
1000	2	R	100 R Mystik 94 2473	93-96	0,60	BP6ES	7811	-	BPR6EIX	6637	
1000	2	R	100 RT	-	0,60	BP7ES	2412	-	BPR7EIX	4055	
1000	2	R	100 RT 2478	87-96	0,60	BP6ES	7811	-	BPR6EIX	6637	
1000	4	S	RR K46 10	08-11	0,80	LMAR9D-J	1633	-	-	-	
1000	4	S	RR K46 12	10-	0,80	LMAR9D-J	1633	-	-	-	
1000	4	S	RR HP4 K42	11-	0,80	LMAR9D-J	1633	-	-	-	
1100	4	K	LT K589 89V2	91-99	0,50	DCPR7E	3932	-	DCPR7EIX	6046	
1100	4	K	LT Edition spécial	92-99	0,50	DR7EA	7839	-	DR7EIX	5686	
1100	4	K	RS K589 89V2	92-97	0,60	DCPR7E	3932	-	DCPR7EIX	6046	
1100	2	R	GS 259E 94	93-00	0,80	BCPR7ET	2164	-	BCPR7EIX	5690	
1100	2	R	R 259R 94	93-01	0,80	BCPR7ET	2164	-	BCPR7EIX	5690	
1100	2	R	RS 259S 93	92-01	0,80	BCPR7ET	2164	-	BCPR7EIX	5690	
1100	2	R	RT	95-00	0,80	BKR6EKC	2848	-	BKR6EIX	6418	
1100	2	R	S 259S 98	96-02	0,80	BKR6EKC	2848	-	BKR6EIX	6418	
1100	2	R	S 259S 98	03-05	2 Bougies par Cylindre	0,80	BKR7EKC+	7354+	-	BKR7EIX+	2667+
					+0,80	DCPR8EKC	7168	-	DCPR8EIX	6546	
1100	2	R	S Boxer Cup (non Twin Spark)	02-03	0,80	BKR7EKC	7354	-	BKR7EIX	2667	

CYL.	Nb Cyl.	TYPE	MODÈLE		INFO			N° STOCK	N° BLISTER		N° STOCK IX
1100	2	R	S 72kW (non Twin Spark)	98-03	2 Bougies par Cylindre	0,80	BKR7EKC	7354	-	BKR7EIX	2667
1150	2	R	GS R21 00	99-02		0,80	BKR7EKC	7354	-	BKR7EIX	2667
1150	2	R	GS R21 00	03	2 Bougies par Cylindre	0,80 +0,80	BKR7EKC+ DCPR8EKC	7354+ 7168	-	BKR7EIX+ DCPR8EIX	2667+ 6546
150	2	R	GS Adventure R21A	01-02		0,80	BKR7EKC	7354	-	BKR7EIX	2667
1150	2	R	GS Adventure R21A	03-05	2 Bougies par Cylindre	0,80 +0,80	BKR7EKC+ DCPR8EKC	7354+ 7168	-	BKR7EIX+ DCPR8EIX	2667+ 6546
1150	2	R	R R28 01	99-02		0,80	BKR7EKC	7354	-	BKR7EIX	2667
1150	2	R	R R28 01	02-06	2 Bougies par Cylindre	0,80 +0,80	BKR7EKC+ DCPR8EKC	7354+ 7168	-	BKR7EIX+ DCPR8EIX	2667+ 654
1150	2	R	R Rockster R28	02-05	2 Bougies par Cylindre	0,80 +0,80	BKR7EKC+ DCPR8EKC	7354+ 7168	-	BKR7EIX+ DCPR8EIX	2667+ 6546
1150	2	R	RS R22 01	00-02		0,80	BKR7EKC	7354	-	BKR7EIX	2667
1150	2	R	RS R22 01	03-04	2 Bougies par Cylindre	0,80 +0,80	BKR7EKC+ DCPR8EKC	7354+ 7168	-	BKR7EIX+ DCPR8EIX	2667+ 6546
1150	2	R	RT R22 00	00-02		0,80	BKR7EKC	7354	-	BKR7EIX	2667
1150	2	R	RT R22 00	03-06	2 Bougies par Cylindre	0,80 +0,80	BKR7EKC+ DCPR8EKC	7354+ 7168	-	BKR7EIX+ DCPR8EIX	2667+ 6546
1200	2	HP2		05-	2 Bougies par Cylindre	0,80 +0,80	BKR7EKC+ DCPR8EKC	7354+ 7168	-	BKR7EIX+ DCPR8EIX	2667+ 6546
1200	2	HP2	Enduro K25	04-06		0,80	DCPR8EKC	7168	-	DCPR8EIX	6546
1200	2	HP2	Megamoto K25	06-08		0,90	DCPR8EKC	7168	-	DCPR8EIX	6546
1200	2	HP2	Sport K29	07-10		0,80	MAR9B-JDS	1316	-	-	-
1200	4	K	LT K589 89V3 99	97-04		0,60	DCPR7E	3932	-	DCPR7EIX	6046
1200	4	K	GT K41 01	02-05		0,60	DCPR7E	3932	-	DCPR7EIX	6046
1200	4	K	GT K44	04-08		0,80	KR9CI	7795	-	-	-
1200	4	K	R	05-	2 Bougies par Cylindre	0,90	DCPR8EKC	7168	-	DCPR8EIX	6546
1200	4	K	R K43	04-08		0,80	KR9CI	7795	-	-	-
1200	4	K	R Sport K43	05-07		0,80	KR9CI	7795	-	-	-
1200	4	K	RS K589 89V3 97	96-01		0,60	DCPR7E	3932	-	DCPR7EIX	6046
1200	4	K	S K40	03-08		0,80	KR9CI	7795	-	-	-
1200	4	K	S	05-		0,90	DCPR8EKC	7168	-	DCPR8EIX	6546
1200	4	R	C 259C 59C1 97	96-03		0,80	BKR6EKC	2848	-	BKR6EIX	6418
1200	2	R	C 259C 59C1 03	03-09	2 Bougies par Cylindre	0,80 +0,80	BKR7EKC+ DCPR8EKC	7354+ 7168	-	BKR7EIX+ DCPR8EIX	2667+ 6546
1200	4	R	CL K30	01-03		0,80	BKR7EKC	7354	-	BKR7EIX	2667
1200	4	R	CL K30	03-04	2 Bougies par Cylindre	0,80 +0,80	BKR7EKC+ DCPR8EKC	7354+ 7168	-	BKR7EIX+ DCPR8EIX	2667+ 6546
1200	4	R	C Independent 259C 59C3 00	00-03		0,80	BKR6EKC	2848	-	BKR6EIX	6418
1200	4	R	C Montauk 259C 59C2 03	02-04	2 Bougies par Cylindre	0,80 +0,80	BKR7EKC+ DCPR8EKC	7354+ 7168	-	BKR7EIX+ DCPR8EIX	2667+ 6546
1200	2	R	GS K25 04/08	02-09		0,80	DCPR8EKC	7168	-	DCPR8EIX	6546
1200	2	R	GS K25 10	08-13		0,80	MAR8B-JDS	8765	-	-	-
1200	2	R	GS Adventure K25 06/08	05-09		0,80	DCPR8EKC	7168	-	DCPR8EIX	6546
1200	2	R	GS Adventure K25 10	08-13		0,80	MAR8B-JDS	8765	-	-	-
1200	2	R	GS DOHC 110kW	10-	2 Bougies par Cylindre	0,80	MAR8B-JDS	8765	-	-	-
1200	2	R	GS K50	11-		0,80	LMAR8D-J	93444	-	-	-
1200	4	R	GS Rallye	12-		0,80	MAR8B-JDS	8765	-	-	-
1200	2	R	R K27 06	05-10		0,90	DCPR8EKC	7168	-	DCPR8EIX	6546
1200	2	R	R K27 11	09-		0,80	MAR8B-JDS	8765	-	-	-
1200	2	R	RT K26 05	03-09		0,80	DCPR8EKC	7168	-	DCPR8EIX	6546
1200	2	R	RT K26 10	08-		0,80	MAR8B-JDS	8765	-	-	-
1200	2	R	RT DOHC 110kW	09-	2 Bougies par Cylindre	0,80	MAR8B-JDS	8765	-	-	-
1200	2	R	S K29	04-07		0,80	DCPR8EKC	7168	-	DCPR8EIX	6546
1200	2	R	ST K28	03-07		0,80	DCPR8EKC	7168	-	DCPR8EIX	6546
1300	4	K	GT K44	07-10		0,80	KR9CI	7795	-	-	-
1300	4	K	R K43, S K40	07-		0,80	KR9CI	7795	-	-	-
1300	4	K	S Pack HP	12-		0,80	KR9CI	7795	-	-	-
1600	6	K	GT K48, GTL K48	10-		0,80	LMAR8AI-8	92288	-	-	-



BOMBARDIER voir CAN-AM



BOOM TRIKE

1600	4		Classic Trike Chopper/Family VW-carbu.	-	Origine	0,60	B6HS	4510	09	BR6HIX	3419
1600	4		Classic Trike Chopper/Family VW-carbu.	-	Préparé	0,60	B7HS	5110	03	BR7HIX	7067
1600	4		Classic Trike Chopper/Family VW-inj.	-	Origine	0,80	BP5ES-A	2285	-	BPR5EIX	6597
1600	4		Classic Trike Low Rider VW-carbu.	-	Origine	0,60	B6HS	4510	09	BR6HIX	3419
1600	4		Classic Trike Low Rider VW-carbu.	-	Préparé	0,60	B7HS	5110	03	BR7HIX	7067
1600	4		Classic Trike Low Rider VW-inj.	-	Origine	0,80	BP5ES-A	2285	-	BPR5EIX	6597
1600	4		Fighter Auto. Moteur Ford	-		1,30	PTR5A-13	2467	-	-	-
2000	4		Fighter Auto. Moteur Ford	-		1,30	PTR5A-13	2467	-	-	-

BSM (Biker Street Motors)

CYL. Nb Cyl. TYPE MODÈLE



INFO



N° STOCK

N° BLISTER



N° STOCK IX

BSM (Biker Street Motors)





50	1		Thunderbike, Winner	99-	0,70	BPR7HS	6422	14	BPR7HIX	5944
50	1	Cat	City, Off Road	99-01	0,70	BPR7HS	6422	14	BPR7HIX	5944
100	1		Thunderbike 2 Temps	99-	0,70	BPR7HS	6422	14	BPR7HIX	5944
125	1		Thunderbike 4 Temps	99-	0,70	CR7HSA	4549	07	CR7HIX	7544
125	1	FT		99-	0,60	DR8EA	7162	11	DR8EIX	6681

BUELL

984	2	XB-9R	Firebolt, Lightning	02-	0,90	DPR9EA-9	5329	-	DPR9EIX-9	5545
984	2	XB-9S	Firebolt, Lightning	02-	0,90	DPR9EA-9	5329	-	DPR9EIX-9	5545
984		XB9-SX	Lightning CityX	05-	0,90	DCPR9E	2641	-	DCPR9EIX	2316
984		XB9X	City X	09-	0,90	DCPR9E	2641	-	DCPR9EIX	2316
1000	2	XB9R		01-07	0,90	DCPR9E	2641	-	DCPR9EIX	2316
1000	2	XB9S		03-07	0,90	DCPR9E	2641	-	DCPR9EIX	2316
1000	2	XB9SX		05-07	0,90	DCPR9E	2641	-	DCPR9EIX	2316
1125	2		Café Racer, R	08-	0,70	CR9EKB	2305	-	CR9EIX	3521
1200	2	M2	Cyclone	97-03	0,90	DPR9EA-9	5329	-	DPR9EIX-9	5545
1200	2	S1	Lightning	97-99	0,90	DPR9EA-9	5329	-	DPR9EIX-9	5545
1200		S1	W White Lightning	98-	0,90	DCPR9E	2641	-	DCPR9EIX	2316
1200	2	S3	Thunderbolt, Touring	97-99	0,90	DPR9EA-9	5329	-	DPR9EIX-9	5545
1200	2	X1	Lightning	99-03	0,90	DPR9EA-9	5329	-	DPR9EIX-9	5545
1200	2	XB-12R	Firebolt	03-	0,90	DCPR9E	2641	-	DCPR9EIX	2316
1200	2	XB-12SCG	Lightning	07-	0,90	DCPR9E	2641	-	DCPR9EIX	2316
1200	2	XB-12SS	Lightning	06-07	0,90	DCPR9E	2641	-	DCPR9EIX	2316
1200		XB-12STT	Lightning	07-	0,90	DCPR9E	2641	-	DCPR9EIX	2316
1200	2	XB-12SX	Lightning City X	-	0,60	DCPR9E	2641	-	DCPR9EIX	2316
1200	2	XB-12X	Ulysse	06-07	0,90	DCPR9E	2641	-	DCPR9EIX	2316

BULTACO

50	1		49	-	0,50	B5HS	4210	-	-	-
50	1		Astro	98-	0,50	B9ES	2611	02	BR9EIX	3981
50	1		Astro Supermotard	00-	0,60	B9ES	2611	02	BR9EIX	3981
50	1		Chispa, GT	-	0,50	B5HS	4210	-	-	-
50	1		Lobito	98-	0,50	B9ES	2611	02	BR9EIX	3981
50	1		Lobito Enduro	99-	0,60	B9ES	2611	02	BR9EIX	3981
50	1		Tiron	-	0,50	B5HS	4210	-	-	-
75	1		Brinco, Junior GT2	-	0,50	B7HS	5110	03	BR7HIX	7067
75	1		Frontera	-	0,50	B8HS	5510	01	BR8HIX	7001
75	1		Lobito, Sherpa T, Streaker	-	0,50	B6HS	4510	09	BR6HIX	3419
100	1		Junior, Lobito	-	0,50	B6HS	4510	09	BR6HIX	3419
100	1		Lobito K, Sherpa S	-	0,50	B9HS	5810	-	BR9HIX	5687
100	1		Tiron	-	0,50	B6HS	4510	09	BR6HIX	3419
125	1		Alpina, Lobito MK3, Lobito MK6	-	0,50	BP5ES	6511	-	BPR5EIX	6597
125	1		Frontera, Junior, Lobito MK7, Mercurio	-	0,50	B6HS	4510	09	BR6HIX	3419
125	1		Pursang MK5	-	0,50	B10EG	3630	-	-	-
125	1		Pursang MK6	-	0,50	B9EG	3530	-	-	-
125	1		Sherco	00-	0,60	BPR5ES	7422	-	BPR5EIX	6597
125	1		Sherpa S	-	0,50	B9EG	3530	-	-	-
125	1		Sherpa T, Streaker, Tralla	-	0,50	B6HS	4510	09	BR6HIX	3419
150	1		Campera, Mercurio, Mercurio GT, Tralla	-	0,50	B6HS	4510	09	BR6HIX	3419
175	1		Alpina, Lobito MK6	-	0,50	BP5ES	6511	-	BPR5EIX	6597
175	1		Campera MK2, Lobito MK7	-	0,50	B5ES	6410	-	-	-
175	1		Mercurio	-	0,50	B6HS	4510	09	BR6HIX	3419
175	1		Mercurio GT	-	0,50	BP5ES	6511	-	BPR5EIX	6597
175	1		Pursang MK5, Sherpa MK3	-	0,50	B9EG	3530	-	-	-
200	1		El Tigre, Mercurio, Metise, Senior	-	0,50	B8ES	2411	05	BR8EIX	5044
200	1		Go Kart, Pursang MK5	-	0,50	B9EG	3530	-	-	-
200	1		Sherco	00-	0,60	BPR5ES	7422	-	BPR5EIX	6597
200	1		Sherpa MK3	-	0,50	B9EG	3530	-	-	-
200	1		Sherpa S	-	0,50	B7ES	1111	-	BR7EIX	6664
250	1		Alpina	-	0,50	BP5ES	6511	-	BPR5EIX	6597
250	1		Astro	-	0,50	B9EG	3530	-	-	-
250	1		Frontera	-	0,50	B8ES	2411	05	BR8EIX	5044
250	1		Matador 250, Matador 250 SD	-	0,50	BP5ES	6511	-	BPR5EIX	6597
250	1		Matador MK2, Matador MK3	-	0,50	B8ES	2411	05	BR8EIX	5044
250	1		Matador MK4	-	0,50	BP6ES	7811	-	BPR6EIX	6637
250	1		Metralla GT	-	0,50	B8ES	2411	05	BR8EIX	5044
250	1		Metralla GTS	-	0,50	BP5ES	6511	-	BPR5EIX	6597
250	1		Metralla MK2, Metralla MK250	-	0,50	B8ES	2411	05	BR8EIX	5044
250	1		Pursang MK4 / MK5 / MK6 / MK7	-	Côté admission 0,50	B8ES	2411	05	BR8EIX	5044
250	1		Pursang MK4 / MK5 / MK6 / MK7	-	Côté échappement 0,50	B9EG	3530	-	-	-

CYL.	Nb Cyl.	TYPE	MODÈLE		INFO			N° STOCK	N° BLISTER		N° STOCK IX
250	1		Sherco	99-		0,60	BPR5ES	7422	-	BPR5EIX	6597
250	1		Sherpa S	-		0,50	B9EG	3530	-	-	-
250	1		Sherpa T	-		0,50	BP5ES	6511	-	BPR5EIX	6597
290	1		Sherco	00-		0,60	BPR5ES	7422	-	BPR5EIX	6597
350	1		Alpina, Matador MK9 / MK10	-		0,50	BP5ES	6511	-	BPR5EIX	6597
350	1		Pursang MK5 / MK6	-	Côté admission	0,50	B8ES	2411	05	BR8EIX	5044
350	1		Pursang MK5 / MK6	-	Côté échappement	0,50	B9EG	3530	-	-	-
360	1		Astro, El Bandito MK2	-	Côté admission	0,50	B8ES	2411	05	BR8EIX	5044
360	1		Astro, El Bandito MK2	-	Côté échappement	0,50	B9EG	3530	-	-	-
360	1		Frontera	-		0,50	B8ES	2411	05	BR8EIX	5044
360	1		Pursang	-	Côté admission	0,50	B8ES	2411	05	BR8EIX	5044
360	1		Pursang	-	Côté échappement	0,50	B9EG	3530	-	-	-
370	1		Frontera MK11	-		0,50	B8ES	2411	05	BR8EIX	5044
370	1		Pursang	-	Côté admission	0,50	B8ES	2411	05	BR8EIX	5044
370	1		Pursang	-	Côté échappement	0,50	B9EG	3530	-	-	-
450	1		Pursang MK15	-		0,50	B8ES	2411	05	BR8EIX	5044



CAGIVA

50	1		City	94-97		0,60	BPR8HS	3725	-	BPR8HIX	6742
50	1		City	98-		0,50	BR8HSA	5539	-	BR8HIX	7001
50	1		City L.E.	93-		0,50	B7HS	5110	03	BR7HIX	7067
50	1		Cocis	-		0,50	B8ES	2411	05	BR8EIX	5044
50	1		Cucciolo	-		0,60	B8HS	5510	01	BR8HIX	7001
50	1		K3	-		0,50	B8ES	2411	05	BR8EIX	5044
50	1		Mantis	99-		0,50	B9ES	2611	02	BR9EIX	3981
50	1		Mito	-		0,50	B10ES	7928	-	BR10EIX	6801
50	1		Passing	-		0,60	BP6HS	4511	-	BPR6HIX	4085
50	1		Prima	-		0,50	B8ES	2411	05	BR8EIX	5044
50	1		Progress 50	-		0,60	B8HS	5510	01	BR8HIX	7001
50	1		Progress Corsa	-		0,60	B9ES	2611	02	BR9EIX	3981
50	1		Scooter	-		0,70	BR8HSA	5539	-	BR8HIX	7001
50	1		Supercity	-		0,50	B8ES	2411	05	BR8EIX	5044
50	1	W4		-		0,50	B8ES	2411	05	BR8EIX	5044
75	1		Cocis	-		0,50	B8ES	2411	05	BR8EIX	5044
75	1		Prima 80, Supercity 80, W4 80	92-		0,50	B8ES	2411	05	BR8EIX	5044
125	1		A8 Trail, Blues	-		0,50	B9ES	2611	02	BR9EIX	3981
125	1		Aletta Rossa, Dakar	-		0,50	B9EG	3530	-	-	-
125	1		Cucciolo	00-		0,70	CR9EB	6955	06	CR9EIX	3521
125	1		Dakar, Elefant 2	-		0,50	B9EG	3530	-	-	-
125	1		Mito 125	91-		0,60	BR9EG	3230	-	-	-
125	1		Mito, Mito E.V.	95-		0,50	B95EGV	2145	-	-	-
125	1		Mito E.V.	98-		0,50	BR9EG	3230	-	-	-
125	1		Mito Racing	-		0,50	B95EGV	2145	-	-	-
125	1		Mito SP525	08-		0,50	BR9EG	3230	-	-	-
125	1		Nuvola	-		0,70	CR7E	4578	12	CR7EIX	7385
125	1		Passing	94-		0,60	BP6HS	4511	-	BPR6HIX	4085
125	1		Planet	98-03		0,50	BR9EG	3230	-	-	-
125	1		Raptor 125	04-		0,50	BR9EG	3230	-	-	-
125	1		RL, SS, SX	-		0,50	B8ES	2411	05	BR8EIX	5044
125	1		Roadster, Roadster 521	-		0,50	B9ES	2611	02	BR9EIX	3981
125	1		Supercity	98-		0,50	BR9EG	3230	-	-	-
125	1	N	90	90-		0,50	B9ES	2611	02	BR9EIX	3981
125	1	K7		-		0,50	B95EGV	2145	-	-	-
125	1	W8	R, Supermotard	96-		0,50	B9ES	2611	02	BR9EIX	3981
250		WMX		-		0,50	B9ES	2611	02	BR9EIX	3981
350	1		Ala Blu 350, Ala Verde 350	-		0,50	B8ES	2411	05	BR8EIX	5044
350	1		Elefant 350, Indiana 350	-		0,50	BP7HS	5111	14	BPR7HIX	5944
350	1		Lucky 350	-		0,90	DP8EA-9	5829	08	DPR8EIX-9	2202
350	1		SST 350	-		0,50	B8ES	2411	05	BR8EIX	5044
450	1		T4 500 E, R	-		0,90	DP8EA-9	5829	08	DPR8EIX-9	2202
500	1		Canyon	-		0,60	DCPR8E	4339	-	DCPR8EIX	6546
500	1		Canyon 500 12mm	-		0,80	DCPR7E	3932	-	DCPR7EIX	6046
500	1	MXR		-		0,50	B95EGV	2145	-	-	-
500	1		Mito	07-		0,70	CR8EB	7784	04	CR8EIX	4218
500			River 500	99-		0,60	DCPR8E	4339	-	DCPR8EIX	6546
600			Canyon, Canyon L.W.	96-		0,70	-	-	-	BKR7EIX	2667
600	1		Canyon 600	98		0,80	BCP7ES	5030	-	BCPR7EIX	5690
600			River	95-		0,70	C7E	5096	12	CR7EIX	7385
600	1	W16		94-		0,70	-	-	-	BKR7EIX	2667
650			Ala Assura	-		0,60	BP7HS	5111	14	BPR7HIX	5944
650			Indiana	-		0,50	BP7HS	5111	14	BPR7HIX	5944
650	2		Raptor, V-Raptor	00-		0,70	CR8E	1275	04	CR8EIX	4218
750	2		Elefant	94-07		0,90	DPR8EA-9	4929	08	DPR8EIX-9	2202
750			Indiana	-		0,50	BP7HS	5111	14	BPR7HIX	5944

CAGIVA

CYL.	Nb Cyl.	TYPE	MODÈLE		INFO		N° STOCK	N° BLISTER		N° STOCK IX	
900	2		Elefant 900 AC	93-97		0,90	DPR9EA-9	5329	-	DPR9EIX-9	5545
900	2		Elefant, ie, GT	90-96		0,90	DPR9EA-9	5329	-	DPR9EIX-9	5545
900	2		Gran Canyon	99-		0,60	DCPR8E	4339	-	DCPR8EIX	6546
1000	2		Navigator / T, Raptor, V-Raptor / Xtra	00-		0,70	CR8EK	3478	-	CR8EIX	4218

CAN-AM

370	1		MX-4, MX-5, Qualifer	-		0,50	B9ES	2611	02	BR9EIX	3981
400	1		MX6, MX400, Qualifer	-		0,50	B9ES	2611	02	BR9EIX	3981
500	1		500 Sonic, Sonic MX	-		0,50	D8EA	2120	11	DR8EIX	6681
1000	2		Spyder Roadster	08-		0,60	DCPR9E	2641	-	DCPR9EIX	2316

CAN-AM / BOMBARDIER - Quad

50	1		Quest	03-		0,80	BPR7HS	6422	14	BPR7HIX	5944
50	1		Quest	04-		0,50	BR9ECS	3570	-	-	-
50	1	DS		02-03		0,70	BPR7HS	6422	14	BPR7HIX	5944
50	1	DS	Rotax	04-		0,70	BR9ECS	3570	-	-	-
70	1	DS		09-		0,70	C6HSA	3228	-	CR6HIX	7274
90	1		Quest 4 Temps	03-		0,70	CR7HSA	4549	07	CR7HIX	7544
90	1		Quest	04-		0,50	BR9ECS	3570	-	-	-
90	1	DS		02-03		0,70	BPR7HS	6422	14	BPR7HIX	5944
90	1	DS	2 Temps	04-		0,70	BR9ECS	3570	-	-	-
90	1	DS	4 Temps	02-		0,70	CR7HSA	4549	07	CR7HIX	7544
90	1	DS		09-		0,70	C6HSA	3228	-	CR6HIX	7274
175	1		Rally	04-		0,70	CR8E	1275	04	CR8EIX	4218
200	1		Rally (4x2)	02-		0,60	CR8E	1275	04	CR8EIX	4218
250	1	DS		-		0,60	CR8E	1275	04	CR8EIX	4218
330	1	HO	325 Outlander 2x4 / 4x4	04-		0,60	DCPR8E	4339	-	DCPR8EIX	6546
330	1		Outlander 330 (Rotax)	04-		0,50	BR9ECS	3570	-	-	-
400			Outlander 4x4	03-		0,60	DCPR8E	4339	-	DCPR8EIX	6546
400		HO	Outlander 2x4 / 4x4 / XT / Max	04-		0,60	DCPR8E	4339	-	DCPR8EIX	6546
498	1		Quest 498, Traxter 498	03-		0,50	BR9ECS	3570	-	-	-
500	1			02-		0,90	DCPR8E	4339	-	DCPR8EIX	6546
500	2		Outlander / Max / XT	-		0,60	DCPR8E	4339	-	DCPR8EIX	6546
500	1		Traxter 7401	99-		0,70	DR8EA	7162	11	DR8EIX	6681
500	1		Traxter 7414	98-		0,70	DR8EA	7162	11	DR8EIX	6681
500			Traxter - Footshift / SM / XL / XT / 4x4	00-02		0,60	DR8EA	7162	11	DR8EIX	6681
500			Traxter Rotax	03-		0,70	BR9ECS	3570	-	-	-
500			514 Quest 4x4	04-		0,60	DCPR8E	4339	-	DCPR8EIX	6546
500			511 Traxter 4x4 XT / XL	04-		0,60	DR8EA	7162	11	DR8EIX	6681
644	1		Quest	03-		0,50	BR9ECS	3570	-	-	-
650			Quest 4x4	02-		0,60	DCPR8E	4339	-	DCPR8EIX	6546
650			DS 4x2	00-		0,60	DR8EA	7162	11	DR8EIX	6681
650			DS 654 Baja, Baja X	04-		0,60	DR8EA	7162	11	DR8EIX	6681
650			610 Quest 4x4, Max, XT	02-03		0,60	DR8EA	7162	11	DR8EIX	6681
650			610 Quest	03-		0,70	BR9ECS	3570	-	-	-
650			Outlander H.O.EFI 4x4	04-		0,60	DCPR8E	4339	-	DCPR8EIX	6546
650	2		Outlander / Max / XT	-		0,60	DCPR8E	4339	-	DCPR8EIX	6546
650	1		Traxter DS / DR	00-		0,70	DR8EA	7162	11	DR8EIX	6681
653	1		653 Quest DS	03-		0,50	BR9ECS	3570	-	-	-
800			Outlander	07-		0,60	DCPR8E	4339	-	DCPR8EIX	6546
800	2		Outlander Max R / R XT / XT-P	-		0,60	DCPR8E	4339	-	DCPR8EIX	6546
800	2		Outlander XY / X xc / X mr	-		0,60	DCPR8E	4339	-	DCPR8EIX	6546
800	2		Outlander Max R LTD	-		0,60	DCPR8E	4339	-	DCPR8EIX	6546
800	2		Renegade R, X xc	-		0,60	DCPR8E	4339	-	DCPR8EIX	6546
1000			Maverick	13-		0,90	LMAR8C-9	93833	-	-	-

CANNONDALE - Quad

432			EX 400, XC 400	01-		0,70	CR9EK	4548	-	CR9EIX	3521
432			FX 400, MX 400	00-		0,70	CR9EK	4548	-	CR9EIX	3521
440			Blaze, Cannibal (4x2), Moto, Speed (4x2)	02-		0,70	CR9EK	4548	-	CR9EIX	3521
440			Glamis	03-		0,70	CR9EK	4548	-	CR9EIX	3521

CARREFOUR

50	1		Web-Gap	00-		0,70	B7HS	5110	03	BR7HIX	7067
125	1	V SX	PFM	00-		0,60	DR8EA	7162	11	DR8EIX	6681

CASAL

50	1		Super Boss RE	99-		0,70	B9HS	5810	-	BR9HIX	5687
----	---	--	---------------	-----	--	------	------	------	---	--------	------



CCM

240	1	240 CMT Trails	-	0,70	BP5ES	6511	-	BPR5EIX	6597
250	1	250 CMT Trails	-	0,70	BP5ES	6511	-	BPR5EIX	6597
310	1	310 CMT Trails	-	0,70	BP5ES	6511	-	BPR5EIX	6597
320	1	320 CMT Trails	-	0,70	BP5ES	6511	-	BPR5EIX	6597
350	1	350 CMT Trails	-	0,70	BP5ES	6511	-	BPR5EIX	6597
400		404 DS, 404 E	03-	0,70	CR8E	1275	04	CR8EIX	4218
400		404XC-Trail	-	0,70	CR8E	1275	04	CR8EIX	4218
400		FT35	05-	0,70	CR8E	1275	04	CR8EIX	4218
400		R35	06-	0,70	CR8E	1275	04	CR8EIX	4218
400		SR40	07-	0,70	CR8E	1275	04	CR8EIX	4218
434		R35 Factory Big Bore Conversion	06-	0,70	CR8E	1275	04	CR8EIX	4218
490	1	490 CMX	-	0,50	B9EG	3530	-	-	-
500	1	500 MTT	-	0,70	DR8EA	7162	11	DR8EIX	6681
560	1	560 CCM 2-T, 560 CCM 4-T	-	0,70	DR8EA	7162	11	DR8EIX	6681
560		CMX 4 Temps	-	0,50	D8EA	2120	11	DR8EIX	6681
600	1	604 R, 604 R30, 604 RS	-	0,70	DR8EA	7162	11	DR8EIX	6681
600	1	604 Supersmoto Dual Sport	01-	0,70	DR8EA	7162	11	DR8EIX	6681
600	1	604 Roadster RS, 604 Trail Dual Sport	01-	0,70	DR8EA	7162	11	DR8EIX	6681
604	1	RS	00-	0,50	D8EA	2120	11	DR8EIX	6681
640	1	640 RS	-	0,70	DR8EA	7162	11	DR8EIX	6681
644		Dual Sport Trail, Dual Supersmoto	00-	0,50	D8EA	2120	11	DR8EIX	6681
644		Moteur Suzuki	02-	0,70	CR10E	6264	-	CR10EIX	6482
644		R30 Supersmotard	02-	0,50	D8EA	2120	11	DR8EIX	6681
644		R30	05-	0,70	CR10E	6264	-	CR10EIX	6482
650	1	644	02-	0,70	CR10EK	2360	-	CR10EIX	6482
650	1	R30 Supersmotard	02-	0,70	CR9EK	4548	-	CR9EIX	3521
710		R30 Moteur Suzuki	05-	0,70	CR10E	6264	-	CR10EIX	6482



CECTEK - Quad

497	1	Quadrift EFI, Gladiator EFI	07-	0,70	CR7E	4578	12	CR7EIX	7385
-----	---	-----------------------------	-----	------	------	------	----	--------	------



CF

125	1	Explorer W, Glory, Ride Glory / W, Wallstreet	-	0,90	DPR7EA-9	5129	13	DPR7EIX-9	7803
-----	---	---	---	------	----------	------	----	-----------	------



CLIPIC

50	1	CJ Trial	00-	0,60	B7HS	5110	03	BR7HIX	7067
50	1	CJ E Trial	00-	0,50	B10ES	7928	-	BR10EIX	6801
80	1	CJ R Trial	00-	0,50	B9ES	2611	02	BR9EIX	3981



COBRA - Quad

80	1	ECX80 AC	09-	0,80	BPR7ES	2023	-	BPR7EIX	4055
----	---	----------	-----	------	--------	------	---	---------	------



CPI - Quad





50	1	200	03-	0,80	BR7ES	5122	-	BR7EIX	6664
50	1	ATV 50	-	0,70	BR7HS	4122	03	BR7HIX	7067
50	1	Crab - 4x2, Dirt Demon - 4x2	02-	0,70	BR8HSA	5539	-	BR8HIX	7001
50	1	XT 50 R Quad	-	0,70	BR7HS	4122	03	BR7HIX	7067
100	1	ATV 100	-	0,70	BR7HS	4122	03	BR7HIX	7067
100	1	Crab - 4x2, Dirt Demon - 4x2	02-	0,70	BR8HSA	5539	-	BR8HIX	7001
200	1	ATV 200	-	0,70	BR7HS	4122	03	BR7HIX	7067
250	1	XS	06-	0,80	CR7HSA	4549	07	CR7HIX	7544



DAELIM

50	1	Cordi	04-	0,60	BPR6HS	7022	-	BPR6HIX	4085
50	1	E-Five	03-	0,70	BR8HSA	5539	-	BR8HIX	7001
50	1	Message 49	98-	0,70	BR8HSA	5539	-	BR8HIX	7001
50	1	Message II	99-	0,60	BR8HSA	5539	-	BR8HIX	7001
50	1	S-Five	02-	0,60	BR8HSA	5539	-	BR8HIX	7001
50	1	Tapo	98-	0,60	BR8HSA	5539	-	BR8HIX	7001
100	1	Altino "A.S"	98-	0,90	CR8EH-9	5666	10	CR8EHIX-9	3797
100	1	Delpino 100	99-	0,70	B8HS	5510	01	BR8HIX	7001
110	1	Citi Ace 110	03-	0,70	C7HSA	4629	07	CR7HIX	7544

DAELIM

CYL.	Nb Cyl.	TYPE	MODÈLE		INFO			N° STOCK	N° BLISTER		N° STOCK IX
125	1		Advance	97-		0,90	CR8EH-9	5666	10	CR8EHIX-9	3797
125	1	NF	Altino 125 ES	02-		0,90	C8EH-9	7473	10	CR8EHIX-9	3797
125	1		Classic	00-		0,90	CR8EH-9	5666	10	CR8EHIX-9	3797
125	1		Daystar	00-		0,90	C8EH-9	7473	10	CR8EHIX-9	3797
125	1		Evolution	97-		0,90	CR8EH-9	5666	10	CR8EHIX-9	3797
125	1		Evolution VS	02		0,90	C8EH-9	7473	10	CR8EHIX-9	3797
125	1		Fellow	98-99		0,90	CR8EH-9	5666	10	CR8EHIX-9	3797
125	1		Freewing 125	05-		0,90	CR8EH-9	5666	10	CR8EHIX-9	3797
125	1		Freewing 125 Fi (Injection)	07-		0,90	CR8EH-9	5666	10	CR8EHIX-9	3797
125			History	04-		0,90	CR8EH-9	5666	10	CR8EHIX-9	3797
125			Otello	03-		0,90	CR8EH-9	5666	10	CR8EHIX-9	3797
125			Roadwin	-		0,90	CR8EH-9	5666	10	CR8EHIX-9	3797
125			Roadwin 125 R	07-		0,90	CR9EH-9	7502	-	CR9EHIX-9	6216
125			S2, S2 Freewing	05-06		0,90	CR8EH-9	5666	10	CR8EHIX-9	3797
125			Besbi	08-		0,70	CR7HSA	4549	07	CR7HIX	7544
125		NS	Fellow, Fellow II	98-00		0,90	CR8EH-9	5666	10	CR8EHIX-9	3797
125		NS	II DLX	01-		0,90	CR8EH-9	5666	10	CR8EHIX-9	3797
125		NS	Trans Eagle	98-		0,90	CR8EH-9	5666	10	CR8EHIX-9	3797
125		NS		08-		0,70	CR7HSA	4549	07	CR7HIX	7544
125		VC	Advance	95-		0,90	C8EH-9	7473	10	CR8EHIX-9	3797
125		VEE		-		0,90	CR8EH-9	5666	10	CR8EHIX-9	3797
125		VJ	Roadwin	03-04		0,90	CR8EH-9	5666	10	CR8EHIX-9	3797
125		VL	Daystar, Daystar Classic	00-		0,90	CR8EH-9	5666	10	CR8EHIX-9	3797
125		VL	L Daystar	02		0,90	C8EH-9	7473	10	CR8EHIX-9	3797
125		VS	Advance, Evolution	97-		0,90	CR8EH-9	5666	10	CR8EHIX-9	3797
125		VT	Evolution	98-		0,90	CR8EH-9	5666	10	CR8EHIX-9	3797
125		SL	History 125	-		0,90	CR8EH-9	5666	10	CR8EHIX-9	3797



DAFIER

50	1	DFE	QT-5, QT-6, QT-8	-		0,60	CR7HSA	4549	07	CR7HIX	7544
125	1	DFE	T-8A, T-10A, T-10D, T-10E	-		0,70	DR8EA	7162	11	DR8EIX	6681







DAREN - Quad

50	1		4x2	99-		0,70	BPR7HS	6422	14	BPR7HIX	5944
100	1		4x2	99-		0,70	BPR7HS	6422	14	BPR7HIX	5944
125	1		4x2	99-		0,60	DR8EA	7162	11	DR8EIX	6681
150	1		4x2	99-		0,60	DR8EA	7162	11	DR8EIX	6681



DERBI

50	1		Aceno	98-		0,60	B8HS	5510	01	BR8HIX	7001
50	1		Atlantis 2 Temps	03-		0,60	BR9ES	5722	02	BR9EIX	3981
50			Atlantis 4 Temps	04-		0,70	CR8EB	7784	04	CR8EIX	4218
50	1		Atlantis 4 Temps	07-		0,70	PMR7A	4259	-	-	-
50	1		Atlantis Bullet, Atlantis City	03-		0,60	BR9ES	5722	02	BR9EIX	3981
50	1		Atlantis LC	99-		0,60	B9ES	2611	02	BR9EIX	3981
50	1		Atlantis O2	99-		0,60	B8HS	5510	01	BR8HIX	7001
50	1		Atlantis Red Bullet	99-		0,60	B9ES	2611	02	BR9EIX	3981
50	1		Aventura 50	95-		0,60	B8HS	5510	01	BR8HIX	7001
50			Black Devil, Black Edition	03-		0,60	B8ES	2411	05	BR8EIX	5044
50			Black Mini	03-		0,60	CR9E	6263	06	CR9EIX	3521
50	1		Boulevard 2 Temps	09-		0,60	BR9ES	5722	02	BR9EIX	3981
50	1		Dirt Boy 10/10, Dirt Kid 10/12	03-		0,70	CR9E	6263	06	CR9EIX	3521
50			DRD 50 Supermoto	02-		0,50	B8ES	2411	05	BR8EIX	5044
50	1		FDS Super, Start DS	92-		0,60	B8HS	5510	01	BR8HIX	7001
50	1		Fenix	96-		0,60	B8HS	5510	01	BR8HIX	7001
50	1		Furax	95-		0,60	B8HS	5510	01	BR8HIX	7001
50	1		Hunter (D+A)	95-		0,60	BP7HS	5111	14	BPR7HIX	5944
50	1		Hunter (Spain)	95-		0,60	B8HS	5510	01	BR8HIX	7001
50	1		MXR	96-		0,60	B8HS	5510	01	BR8HIX	7001
50	1		Manhattan	-		0,60	B8HS	5510	01	BR8HIX	7001
50	1		Paddock	97-		0,60	B8HS	5510	01	BR8HIX	7001
50	1		Paddock LC, Predator LC	98-		0,60	B9ES	2611	02	BR9EIX	3981
50	1		Racing Replica	02-		0,60	BR9ES	5722	02	BR9EIX	3981
50	1		Rambla 50	-		0,60	BR9ES	5722	02	BR9EIX	3981
50	1		RD-2 Country	92-		0,60	B8HS	5510	01	BR8HIX	7001
50	1		Red Bullet	03-		0,60	BR9ES	5722	02	BR9EIX	3981
50	1		Senda L, R, SM	96-99		0,60	B9ES	2611	02	BR9EIX	3981
50	1		Senda R & SM 00	00-		0,60	B9ES	2611	02	BR9EIX	3981
50	1		Senda DRD PRO R, Senda DRD PRO SM	09-		0,60	BR8ES	5422	05	BR8EIX	5044
50	1		Sonar 50 2T	10-		0,70	BR9ES	5722	02	BR9EIX	3981

CYL.	Nb Cyl.	TYPE	MODÈLE		INFO			N° STOCK	N° BLISTER		N° STOCK IX
50	1		Urban	95-		0,60	B8HS	5510	01	BR8HIX	7001
50	1		Vamos FL, Vamos L	94-		0,60	BR8HS	4322	01	BR8HIX	7001
50	1		Variant AIR	03-		0,50	B8HS	5510	01	BR8HIX	7001
50	1		Variant Box, Sport R, Top	92-		0,60	B8HS	5510	01	BR8HIX	7001
50		GP1		03-		0,70	BR10ES	4832	-	BR10EIX	6801
50		GPR		02-		0,50	B8ES	2411	05	BR8EIX	5044
50	1	GPR		09-		0,60	BR8ES	5422	05	BR8EIX	5044
50	1	GPR	Naked	04-		0,70	B8ES	2411	05	BR8EIX	5044
50	1	GPR	Nude	-		0,50	B8ES	2411	05	BR8EIX	5044
50	1	GPR	R, Racing	02-		0,50	B8ES	2411	05	BR8EIX	5044
50	1	GPR	Replica	03-		0,50	B8ES	2411	05	BR8EIX	5044
50		GPR	Full power	02-		0,60	B9ES	2611	02	BR9EIX	3981
50	1	GPR	R, Réplica	97-		0,60	B10HS	2399	-	BR10HIX	6692
50	1	X	Race, Race R, Treme	-		0,50	B8ES	2411	05	BR8EIX	5044
75	1		1001, Extra Sport Coppa	-		0,50	B8ES	2411	05	BR8EIX	5044
75	1		CR 74	-		0,50	B10EGV	5927	-	-	-
75	1		Europa RD15, Scoot 74	-		0,50	B8ES	2411	05	BR8EIX	5044
75	1		GPR-75, Sport-75	-		0,50	B10ES	7928	-	BR10EIX	6801
75	1		Gran Prix 74	-		0,50	B6HS	4510	09	BR6HIX	3419
75	1		Vivo-75	-		0,60	BP5HS	4111	-	-	-
80	1		BI 3	95-		0,60	B8ES	2411	05	BR8EIX	5044
85			Senda 100	97-		0,60	B9ES	2611	02	BR9EIX	3981
100	1	R	Atlantis	00-		0,60	B9ES	2611	02	BR9EIX	3981
125			Boulevard 4 Temps	03-		0,60	CPR8E	7411	-	-	-
125	1		Boulevard 4 Temps AC	03-		0,70	CR9E	6263	06	CR9EIX	3521
125	1		Boulevard 4 Temps - Piaggio ref.air	08-		0,80	CR7EB	4663	12	CR7EIX	7385
125	1		Cross City 125	07-		0,70	DR8EA	7162	11	DR8EIX	6681
125	1		CRS, RC	-		0,50	B10EGV	5927	-	-	-
125	1		Enduro, RS125TT, Karmathan	-		0,50	B9EGV	5827	-	-	-
125			HDR Cabriolet	00-		0,50	CR7E	4578	12	CR7EIX	7385
125	1	GPR	Nude, Racing	04-		0,80	BR8ES	5422	05	BR8EIX	5044
125	1		GPR 125 4V	09-		0,80	CR8EB	7784	04	CR8EIX	4218
125	1		Mulhacen, Mulhacen Café	07-		0,60	CR8EB	7784	04	CR8EIX	4218
125	1		Rambra	-		0,60	BR9ES	5722	02	BR9EIX	3981
125	1		Rambra 4 temps	-		0,80	CR8EB	7784	04	CR8EIX	4218
125	1		Sport Coppa, TTS9	-		0,50	B9ES	2611	02	BR9EIX	3981
125	1		Terra, Terra Adventure	07-		0,60	CR8EB	7784	04	CR8EIX	4218
125	1		Senda R 4 Temps, Senda SM	04-		0,90	DPR8EA-9	4929	08	DPR8EIX-9	2202
125	1	DRD	Senda SM, Senda R	09-		0,60	CR8EB	7784	04	CR8EIX	4218
125	1	GP1		06-		0,70	CR9EB	6955	06	CR9EIX	3521
125	1	TW	Cross City 125, Senda Baja ('R)125	07-		0,80	D8EA	2120	11	DR8EIX	6681
150			Boulevard 4T	03-		0,60	CPR8E	7411	-	-	-
200	1		2002, Gran Prix, 6V	-		0,50	B9ES	2611	02	BR9EIX	3981
250	1		GP1	06-		0,70	CR9EB	6955	06	CR9EIX	3521
250	1		GP1, GP1 Racing	07-		0,70	PMR8B	6378	-	-	-
250	1		CRX, RC, Enduro	-		0,50	B10EGV	5927	-	-	-
250	1		Rambra 250	-		0,70	PMR8B	6378	-	-	-
250	1		Turismo 250	-		0,50	B9ES	2611	02	BR9EIX	3981
300	1		Rambra 300i	10-		0,70	CR8EKB	4374	-	CR8EIX	4218
660	1		Mulhacen 659, Mulhacen 659 Café	05-		0,60	CR7E	4578	12	CR7EIX	7385



DERBI - Quad

170	1			-		0,70	DR8EA	7162	11	DR8EIX	6681
250	1		DXR	04-		0,70	CR8HSA	2086	-	CR8HIX	7669







DINLI - Quad

50	1		Cobia DL-503	-		0,60	BPR7HS	6422	14	BPR7HIX	5944
50	1		Diamond Back DL601-50 2 Temps	-		0,80	BPR7HS	6422	14	BPR7HIX	5944
50	1		Dino (4x2)	02-		0,80	BPR7HS	6422	14	BPR7HIX	5944
50	1		Helix	04-		0,80	BPR7HS	6422	14	BPR7HIX	5944
50	1		JP DL502-51 2 Temps	-		0,60	BPR7HS	6422	14	BPR7HIX	5944
50	1		T-Rex (4x2)	03-		0,80	BPR7HS	6422	14	BPR7HIX	5944
90	1		Beast DL602-90 2 Temps	-		0,80	BPR7HS	6422	14	BPR7HIX	5944
90	1		Diamond Back DL601-90 2 Temps	-		0,80	BPR7HS	6422	14	BPR7HIX	5944
90	1		Helix DL603-90 2 Temps	-		0,70	BPR7HS	6422	14	BPR7HIX	5944
100	1		Helix	04-		0,80	BPR7HS	6422	14	BPR7HIX	5944
100	1		T-Rex (4x2)	03-		0,80	BPR7HS	6422	14	BPR7HIX	5944
150	1		Diablo, Enforcer, Helix	04-		0,70	CR7HSA	4549	07	CR7HIX	7544
450		DMX	DL901	05-		0,60	DCPR8E	4339	-	DCPR8EIX	6546



DUCATI

160	1		160 Monza	-	0,60	B7HS	5110	03	BR7HIX	7067
350			Desmo	-	0,50	B7HS	5110	03	BR7HIX	7067
350	2		Forza, MK III D	-	0,50	B6HS	4510	09	BR6HIX	3419
350			Sport	92-	0,60	B7HS	5110	03	BR7HIX	7067
400			Monster	-05	0,70	DCPR8E	4339	-	DCPR8EIX	6546
500			Desmo	-	0,50	B7HS	5110	03	BR7HIX	7067
500	2		SL Pantah	-	0,60	BPR7HS	6422	14	BPR7HIX	5944
600			Super Sport	94-	0,60	DCPR8E	4339	-	DCPR8EIX	6546
600	2	M	Monstro , Monstro Dark	-98	0,60	DCPR8E	4339	-	DCPR8EIX	6546
600	2	M	Monster	94-01	0,60	DCPR8E	4339	-	DCPR8EIX	6546
600	2		SS	94-97	0,70	-	-	-	DCR8EIX	3606
620	2		Monster Dark SD et DD	04-	0,60	DCPR8E	4339	-	DCPR8EIX	6546
620	2		Multistrada	05-07	0,60	DCPR8E	4339	-	DCPR8EIX	6546
620	2	M	i.E.	02-06	0,60	DCPR8E	4339	-	DCPR8EIX	6546
620	2	S	Sport	02-	0,60	DCPR8E	4339	-	DCPR8EIX	6546
650	2		650 Indiana	87-	0,60	BP7HS	5111	14	BPR7HIX	5944
695	2		Monster 695	06-07	0,90	DCPR8E	4339	-	DCPR8EIX	6546
700	2		Monster 696 (80PS)	08-	0,90	DCPR8E	4339	-	DCPR8EIX	6546
748	2		R	99-	0,60	-	-	-	DCR9EIX	6650
748	2		R	00-04	0,60	R2349-10	6839	-	-	-
748	2		SP, SPS	95-03	0,60	-	-	-	DCR9EIX	6650
748	2		Strada, Biposto	95-	0,60	-	-	-	DCR9EIX	6650
749	2		R, S	03-	0,70	CR9EB	6955	06	CR9EIX	3521
750	2		F1, F1 LS	85-	0,70	-	-	-	DCR8EIX	3606
750	2		Indiana	87-	0,60	BPR7HS	6422	14	BPR7HIX	5944
750	2		Paso	86-	0,90	DPR8EA-9	4929	08	DPR8EIX-9	2202
750	2		Sport	88-00	0,90	DPR8EA-9	4929	08	DPR8EIX-9	2202
750	2	M	Mostro	-98	0,60	DCPR8E	4339	-	DCPR8EIX	6546
750	2		Monster 750	96-97	0,70	-	-	-	DCR8EIX	3606
750	2	M	Monster	97-02	0,60	DCPR8E	4339	-	DCPR8EIX	6546
750	2	SS	HF i.E.	-	0,70	-	-	-	DCR8EIX	3606
750	2	SS	SuperSport	94-00	0,60	-	-	-	DCR9EIX	6650
750	2	SS	Sport & Supersport ie	00-	0,90	DPR7EA-9	5129	13	DPR7EIX-9	7803
800	2		Hypermotard 796	09-	0,60	DCPR8E	4339	-	DCPR8EIX	6546
800	2		Monster 796	09-	0,90	DCPR8E	4339	-	DCPR8EIX	6546
800	2		Monster Standart	04-	0,60	DCPR8E	4339	-	DCPR8EIX	6546
800	2	S2R	Monster	05-07	0,60	DCPR8E	4339	-	DCPR8EIX	6546
800	2	S	Monster i.E	03-	0,60	DCPR8E	4339	-	DCPR8EIX	6546
800	2	SS	Sport & Supersport ie	03-	0,60	DCPR8E	4339	-	DCPR8EIX	6546
848			Dark	07-	0,80	MAR10A-J	4706	-	-	-
850	2		848	08-	0,80	MAR10A-J	4706	-	-	-
851	2		i.E., Superbike Racing	-	0,60	-	-	-	DCR9EIX	6650
860	2		Desmo SS	-	0,50	B6HS	4510	09	BR6HIX	3419
888	2		851 S.P.,II,III,IV	-	0,60	-	-	-	DR9EIX	4772
888	2		SP1, SP5 Racing, Strada	-	0,60	-	-	-	DCR9EIX	6650
900	2		Mhe	02-	0,60	DCPR8E	4339	-	DCPR8EIX	6546
900	2		Darmah	-	0,60	BP6HS	4511	-	BPR6HIX	4085
900	2		SL, SS	91-	0,90	DPR9EA-9	5329	-	DPR9EIX-9	5545
900	2		Superlight	92-	0,60	DCPR8E	4339	-	DCPR8EIX	6546
900	2		Supersport Final Edition	98-	0,60	DCPR8E	4339	-	DCPR8EIX	6546
900	2	M	Monstro	-99	0,60	DCPR8E	4339	-	DCPR8EIX	6546
900	2	M	Monster S ie	99-	0,60	DCPR8E	4339	-	DCPR8EIX	6546
900	2	MH	Evoluzione	00-	0,60	DCPR8E	4339	-	DCPR8EIX	6546
900	2	SS	Sport & Supersport ie	99-	0,90	DCPR8E	4339	-	DCPR8EIX	6546
906	2		Paso	-	0,60	DCPR8E	4339	-	DCPR8EIX	6546
907	2		i.E.	-	0,60	DCPR8E	4339	-	DCPR8EIX	6546
916	2		Strada, Biposto, Senna	94-97	0,50	-	-	-	DCR9EIX	6650
916	2		SP, SPS	94-97	0,60	R2349-10	6839	-	-	-
916	2		ST4	98-	0,60	-	-	-	DCR9EIX	6650
916	2	M	Monster S4	00-03	0,50	-	-	-	DCR9EIX	6650
944	2		ST2	97-03	0,60	DCPR8E	4339	-	DCPR8EIX	6546
972	2		Mille	-	0,60	BP7HS	5111	14	BPR7HIX	5944
989	4		Desmosedici RR	08-	0,80	MAR10A-J	4706	-	-	-
990	4		DESMO 16RR	07-	0,60	MAR10A-J	4706	-	-	-
992	2		Multistrada	04-	0,60	DCPR8E	4339	-	DCPR8EIX	6546
992	2	ST3		04-	0,60	CR9EB	6955	06	CR9EIX	3521
992	2		GT, Sport S, Touring	06-10	0,60	DCPR8E	4339	-	DCPR8EIX	6546
996	2		916 SP, 916 SPS	98-	0,50	R2349-9	4418	-	-	-
996	2		996 SP, 996 SPS	98-	0,60	R2349-9	4418	-	-	-
996	2	ST4S	ABS	04-	0,60	-	-	-	DCR9EIX	6650
996	2	S4R	Monster	04-	0,60	-	-	-	DCR9EIX	6650
996	2		Monster S4R	04-05	0,80	-	-	-	DCR9EIX	6650

CYL.	Nb Cyl.	TYPE	MODÈLE		INFO			N° STOCK	N° BLISTER		N° STOCK IX
996	2		ST4 S	03-05		0,50	-	-	-	DCR9EIX	6650
996	2		Strada, Biposto, SP / SPS / SPS Factory	98-		0,50	-	-	-	DCR9EIX	6650
996	2		SPS Racing	99-00		0,60	R2349-10	6839	-	-	-
996	2		R	01-		0,60	R2349-10	6839	-	-	-
998	2		R	01-		0,60	R2349-10	6839	-	-	-
998	2		999 R, 999 S	02-06		0,60	CR9EB	6955	06	CR9EIX	3521
998	2	S4RS	Monster	06-08		0,60	CR9EB	6955	06	CR9EIX	3521
998	2	S4R	Monster	07-		0,80	MAR10A-J	4706	-	-	-
1000	2		Monster Standart	04-		0,60	DCPR8E	4339	-	DCPR8EIX	6546
1000	2		Monster 1000 i.e.	03-05		0,70	-	-	-	DCR8EIX	3606
1000	2		Multistrada/S/DS	05-06		0,90	DCPR8E	4339	-	DCPR8EIX	6546
1000	2		Paul Smart	06-		0,60	DCPR8E	4339	-	DCPR8EIX	6546
1000	2		Sport Naked	07-		0,60	DCPR8E	4339	-	DCPR8EIX	6546
1000	2	DS	Monster	03-		0,60	DCPR8E	4339	-	DCPR8EIX	6546
1000	2	S	Sport	07-		0,60	DCPR8E	4339	-	DCPR8EIX	6546
1000	2	S2R	Monster	06-08		0,90	DCPR8E	4339	-	DCPR8EIX	6546
1000	2	SS	DS, Sport & Supersport ie	03-		0,60	DCPR8E	4339	-	DCPR8EIX	6546
1000	2	ST3	ST3	04-08		0,60	CR9EB	6955	06	CR9EIX	3521
1000	2		Classic Sport 1000	06-09		0,90	DCPR8E	4339	-	DCPR8EIX	6546
1078	2		Hypermotard	07-		0,90	DCPR8E	4339	-	DCPR8EIX	6546
1098	2		1098 / 1098S/ Tricolore	07-		0,80	MAR10A-J	4706	-	-	-
1098	2		1098 R	08-09		0,80	MAR10A-J	4706	-	-	-
1098	2		Streetfighter / S	09-		0,80	MAR10A-J	4706	-	-	-
1100	2		Hypermotard / Hypermotard S	07-08		0,60	DCPR8E	4339	-	DCPR8EIX	6546
1100	2		Hypermotard Evo / Evo S	10-		0,60	DCPR8E	4339	-	DCPR8EIX	6546
1100	2		Monster / S / Evo	08-		0,70	DCPR8E	4339	-	DCPR8EIX	6546
1100	2		Multistrada 1100/S	07-		0,90	DCPR8E	4339	-	DCPR8EIX	6546
1100	2		Streetfighter / S	09-		0,80	MAR10A-J	4706	-	-	-
1198	2		1198 R	09-		0,80	MAR10A-J	4706	-	-	-
1198	2		/ S	08-		0,80	MAR10A-J	4706	-	-	-
1198	2		Diavel, Multistrada 1200 / 1200 S	10-		0,80	MAR9A-J	6869	-	-	-
1198	2		S&R Corse / SP	10-		0,80	MAR10A-J	4706	-	-	-



E-TON - Quad

40	1	JXL	Viper Junior (4x2)	03-		0,60	BPM7A	7321	-	-	-
50	1		Draco	06-		0,70	BPR7HS	6422	14	BPR7HIX	5944
50	1	RXL	Viper (4x2)	02-		0,70	BPR7HS	6422	14	BPR7HIX	5944
90	1		Sierra Ranger (4x2)	03-		0,70	BPR7HS	6422	14	BPR7HIX	5944
90	1		Viper (4x2)	02-		0,70	BPR7HS	6422	14	BPR7HIX	5944
150	1		Challenger 150	99-		0,60	C7HSA	4629	07	CR7HIX	7544
150	1	YXL	Yukon (4x2)	98-		0,60	C7HSA	4629	07	CR7HIX	7544
250	1		Vector	-		0,70	CR8E	1275	04	CR8EIX	4218
300	1		Vector	-		0,70	CR8E	1275	04	CR8EIX	4218



ENDRESS

50	1		EMR	-		0,60	BR8HSA	5539	-	BR8HIX	7001
50	1		EMR DJ	97-		0,60	BR8HSA	5539	-	BR8HIX	7001
50	1		EMR Ergon	97-		0,60	BP6HS	4511	-	BPR6HIX	4085



EXPLORER





500	1		Atlas, Everest	-		0,90	DPR7EA-9	5129	13	DPR7EIX-9	7803
525	1		Grumbler	-		0,90	DPR7EA-9	5129	13	DPR7EIX-9	7803
625	1		Bazooka, Grison	-		0,90	DPR7EA-9	5129	13	DPR7EIX-9	7803



FANTIC

50	1		Big Wheel	94-		0,50	B8HS	5510	01	BR8HIX	7001
50	1		Grinta	95-		0,60	B7HS	5110	03	BR7HIX	7067
50	1		Issimo, Issimo Convert/Kick, Junior,Tender To	-		0,50	B5HS	4210	-	-	-
50	1		Queenie	-		0,60	BP7HS	5111	14	BPR7HIX	5944
50	1		Trial	-		0,50	B7HS	5110	03	BR7HIX	7067
75	1		Koala, Oasis	-		0,50	B8ES	2411	05	BR8EIX	5044
75	1		Trial	-		0,50	B8HS	5510	01	BR8HIX	7001
80	1		Caballero	-		0,50	B9ES	2611	02	BR9EIX	3981
80	1		Enduro, RSX	-		0,50	B8EG	3430	-	-	-
80	1		Section	95-97		0,50	BCP7ES	5030	-	BCPR7EIX	5690
125	1		Caballero, Cross, RSX	-		0,50	B9EG	3530	-	-	-
125	1		Professional, Trial / Competicion	-		0,50	B7HS	5110	03	BR7HIX	7067
160	1		TX	-		0,50	B8EG	3430	-	-	-
175	1		Enduro	-		0,50	B8EG	3430	-	-	-
200	1		Trial	-		0,50	B7HS	5110	03	BR7HIX	7067

FANTIC

CYL.	Nb Cyl.	TYPE	MODÈLE		INFO			N° STOCK	N° BLISTER		N° STOCK IX
240	1		Trial 240	-		0,50	B6HS	4510	09	BR6HIX	3419
250			Coach, K-Roo	-		0,50	B8ES	2411	05	BR8EIX	5044
250	1		Section	95-97		0,50	BCP7ES	5030	-	BCPR7EIX	5690
250	1		Trial 301 Competition	-		0,50	BP5ES	6511	-	BPR5EIX	6597
250	1		Trial 301/305/307	-		0,50	B8ES	2411	05	BR8EIX	5044
250	1		TX	-		0,50	B8EG	3430	-	-	-
260			TX	-		0,50	B8EG	3430	-	-	-
300	1		Professional	-		0,50	B8EG	3430	-	-	-
330			TX	-		0,50	B8EG	3430	-	-	-

FOX - Quad

50	1		4x2	00-		0,70	BP7HS	5111	14	BPR7HIX	5944
50	1	VR	Sport 4x2	01-		0,70	BP7HS	5111	14	BPR7HIX	5944
90	1	MT	4x2	98-		0,70	CR7HSA	4549	07	CR7HIX	7544
100			4x2	00-		0,70	BP7HS	5111	14	BPR7HIX	5944

GAS GAS

50	1		Contact, Enducross	-		0,60	B8HS	5510	01	BR8HIX	7001
50	1		Endurocross BOY	-		0,60	BPR5ES	7422	-	BPR5EIX	6597
50	1	EC	Boy	00-		0,60	BPR5ES	7422	-	BPR5EIX	6597
50	1	EC	Rookies	01-		0,60	B9ES	2611	02	BR9EIX	3981
50		SM	Supermotard	04-		0,60	B9ES	2611	02	BR9EIX	3981
50	1	TXT	Boy	00-		0,60	BPR5ES	7422	-	BPR5EIX	6597
50	1	TXT	Boy (Culasse alu)	04-		0,60	BR8ECM	3035	-	BR8ECMIX	3520
65			MC65	06-		0,70	BR10ES	4832	-	BR10EIX	6801
75			Husqvarna (TM)	-		0,50	B10EG	3630	-	-	-
80		TXT		-		0,50	BPR5ES	7422	-	BPR5EIX	6597
125	1		Enduro	02-		0,60	BR8EG	3130	-	-	-
125			Husqvarna (TM)	-		0,50	B10EG	3630	-	-	-
125	1		Trial 125	-		0,50	BP5ES	6511	-	BPR5EIX	6597
125	1	EC	2 Temps	04-		0,60	BR9EG	3230	-	-	-
125	1	EC	Enducross	95-		0,50	B10EGV	5927	-	-	-
125	1	EC	Enducross	97-		0,60	BR9EG	3230	-	-	-
125		EC	Racing, SIX	10-		0,70	BR9EG	3230	-	-	-
125	1	GT	12	94-		0,50	BP5ES	6511	-	BPR5EIX	6597
125	1	JT	12 Contact	95-		0,50	BP5ES	6511	-	BPR5EIX	6597
125	1	MC		04-		0,60	BR9EG	3230	-	-	-
125	1	PP	Pampera	97-		0,60	BPR6ES	7822	-	BPR6EIX	6637
125	1	PP	Pampera 4 Temps	10-		0,80	BPR6ES	7822	-	BPR6EIX	6637
125		SM	Supermotard	-		0,70	BR9EG	3230	-	-	-
125	1	TT		-		0,60	BR8EG	3130	-	-	-
125	1	TT	Cross	-		0,50	B10EGV	5927	-	-	-
125	1	TT	Enducross	94-		0,50	B10EGV	5927	-	-	-
125	1	TX		97-98		0,60	BPR5ES	7422	-	BPR5EIX	6597
125	1	TXT	Pro	04-		0,60	BPR5ES	7422	-	BPR5EIX	6597
125	1	TXT	Trial	99-		0,60	BPR5ES	7422	-	BPR5EIX	6597
143	1		Contact T 16	94-		0,50	BP5ES	6511	-	BPR5EIX	6597
160			GT16 (Refroidissement liquide)	-		0,50	BP5ES	6511	-	BPR5EIX	6597
160	1	JT	16 Contact	95-		0,50	BP5ES	6511	-	BPR5EIX	6597
200	1		Enduro	02-		0,60	BR8EG	3130	-	-	-
200	1		Pampera	-		0,80	BPR6ES	7822	-	BPR6EIX	6637
200	1	EC		99-		0,60	B10EGV	5927	-	-	-
200	1	EC		04-		0,60	BR8EG	3130	-	-	-
200	1	EC	Endurocross	99-		0,50	B10EGV	5927	-	-	-
200		EC	Endurocross	02-		0,50	BR8EG	3130	-	-	-
200	1	TT		-		0,60	BR8EG	3130	-	-	-
200	1	TX		97-98		0,60	BPR5ES	7422	-	BPR5EIX	6597
200	1	TXT	Trial	99-		0,60	BPR5ES	7422	-	BPR5EIX	6597
240	1	GT	25	94-		0,50	BP5ES	6511	-	BPR5EIX	6597
240	1	JT	Contact 25	94-96		0,50	BP5ES	6511	-	BPR5EIX	6597
250	1		Cross 250	-		0,60	BR8EG	3130	-	-	-
250	1		Delta 25 GT	-		0,50	BP5ES	6511	-	BPR5EIX	6597
250	1		Enduro	02		0,60	BR8EG	3130	-	-	-
250	1		Enducross	-		0,50	B10EGV	5927	-	-	-
250			Husqvarna (TM)	-		0,50	B10EG	3630	-	-	-
250	1		Piri-A 6 Magnum, Trial 250 (eau + air)	-		0,50	BP5ES	6511	-	BPR5EIX	6597
250	1	EC		97-		0,50	B8EG	3430	-	-	-
250	1	EC	Enducross	97-		0,60	BR8EG	3130	-	-	-
250	1	EC	EC 2 Temps	04-		0,60	BR8EG	3130	-	-	-
250		EC	Racing, SIX (Incl. Replica) 2 Temps	10-		0,70	BR8EG	3130	-	-	-
250		ECF	4T, SIX 4T	10-11		0,70	CR8E	1275	04	CR8EIX	4218
250		ECF	4T, SIX 4T	12-		0,60	CR9E	6263	06	CR9EIX	3521
250	1	MC	MC	04-		0,60	BR8EG	3130	-	-	-

CYL.	Nb Cyl.	TYPE	MODÈLE		INFO			N° STOCK	N° BLISTER		N° STOCK IX
250	1	PP	Pampera	97-03		0,60	BPR6ES	7822	-	BPR6EIX	6637
250	1	PP	Pampera	04-		0,50	BPR5ES	7422	-	BPR5EIX	6597
250		SM	Supermotard	-		0,50	BR8EG	3130	-	-	-
250	1	TT		-		0,60	BR8EG	3130	-	-	-
250	1	TT	Enducross	-		0,50	B10EGV	5927	-	-	-
250	1	TX		97-98		0,60	BPR5ES	7422	-	BPR5EIX	6597
250	1	TXT		-		0,60	BPR5ES	7422	-	BPR5EIX	6597
250	1	TXT	Pro	01-		0,60	BPR5ES	7422	-	BPR5EIX	6597
250		TXT	Raga Replica	11-		0,60	BPR5ES	7422	-	BPR5EIX	6597
270	1	TX		97-98		0,60	BPR5ES	7422	-	BPR5EIX	6597
270	1	TXT	Trial	99-		0,60	BPR5ES	7422	-	BPR5EIX	6597
280			Pampera	-		0,50	BPR5ES	7422	-	BPR5EIX	6597
280	1	TXT		00-		0,50	BP5ES	6511	-	BPR5EIX	6597
280	1	TXT	Trial	00-		0,60	BPR5ES	7422	-	BPR5EIX	6597
280	1	TXT	Pro	04-		0,60	BPR5ES	7422	-	BPR5EIX	6597
280		TXT	Racing, Raga Replica	11-		0,60	BPR5ES	7422	-	BPR5EIX	6597
300	1		Enduro	02-		0,60	BR8EG	3130	-	-	-
300			Trial	-		0,50	BP5ES	6511	-	BPR5EIX	6597
300	1	EC		99-		0,60	B10EGV	5927	-	-	-
300	1	EC	EC	04-		0,60	BR8EG	3130	-	-	-
300	1	EC	Enducross	99-		0,60	BR8EG	3130	-	-	-
300		EC	Racing, SIX (Incl. Replica) 2T	10-		0,70	BR8EG	3130	-	-	-
300	1	TT		-		0,60	BR8EG	3130	-	-	-
300		TXT	Pro, Racing, Raga Replica	11-		0,60	BPR5ES	7422	-	BPR5EIX	6597
320	1	JT	Contact	95-		0,50	BP5ES	6511	-	BPR5EIX	6597
320	1	TX		97-98		0,60	BPR5ES	7422	-	BPR5EIX	6597
320	1		Pampera	-		0,80	BPR6ES	7822	-	BPR6EIX	6637
321	1	TXT	Trial	99-		0,60	BPR5ES	7422	-	BPR5EIX	6597
325			Trial Halley PXC	-		0,50	B9ES	2611	02	BR9EIX	3981
330	1		Delta 32 GT, Trial	-		0,50	BP5ES	6511	-	BPR5EIX	6597
370	1	JTR		-		0,50	BPR5ES	7422	-	BPR5EIX	6597
370	1	PP	Pampera	97-		0,60	BPR6ES	7822	-	BPR6EIX	6637
400	1		SM	-		0,70	CR8E	1275	04	CR8EIX	4218
450	1		Pampera	07		0,70	CR8E	1275	04	CR8EIX	4218
450	1	EC	4 Temps	05-		0,60	CR8E	1275	04	CR8EIX	4218
400	1	EC	FSE	02		0,70	CR8E	1275	04	CR8EIX	4218
450	1	FSE		04-		0,60	CR8E	1275	04	CR8EIX	4218
450			SM	04-		0,70	CR8E	1275	04	CR8EIX	4218
492		EC	FSR	08-10		0,70	CR8E	1275	04	CR8EIX	4218
500	1		Normada 500	-		0,50	D8EA	2120	11	DR8EIX	6681
515			SM	08-10		0,70	CR8E	1275	04	CR8EIX	4218



GAS GAS - Quad

50	1		Quad 50	-		0,70	B9ES	2611	02	BR9EIX	3981
300			Wild - 4x2	03-		0,60	BR8EG	3130	-	-	-
450			Wild - 4x2	03-		0,60	CR8E	1275	04	CR8EIX	4218



GENERIC

50	1		50.com	-		0,70	BR7ES	5122	-	BR7EIX	6664
50	1		Atura K50, Epico 50	-		0,50	BR8HSA	5539	-	BR8HIX	7001
50	1		Cracker 50, Evolution 50	07-		0,70	BR7ES	5122	-	BR7EIX	6664
50	1		Explorer Cracker 50	-		0,70	BR7ES	5122	-	BR7EIX	6664
50	1		Explorer Kallio 50	-		0,50	BR8HSA	5539	-	BR8HIX	7001
50	1		Explorer Race 50 / Spin 50 / Twister 50	-		0,70	BR7ES	5122	-	BR7EIX	6664
50	1		G-Ride 50.com, G-Ride Evolution 50	-		0,70	BR7ES	5122	-	BR7EIX	6664
50	1		Ideo 50	07-		0,70	BR7ES	5122	-	BR7EIX	6664
50	1		Kallio 50, Onyx 50	-		0,50	BR8HSA	5539	-	BR8HIX	7001
50	1		Limited 50, Omen 50	-		0,70	BR7ES	5122	-	BR7EIX	6664
50			Race 50	11-		0,70	BR8HSA	5539	-	BR8HIX	7001
50	1		Ride 50.com, Ride Cracker, Ride Evolution	-		0,70	BR7ES	5122	-	BR7EIX	6664
50	1		Ride Kallio 50	-		0,50	BR8HSA	5539	-	BR8HIX	7001
50	1		Ride Omen / Race / Slash / Topic / Twister	-		0,70	BR7ES	5122	-	BR7EIX	6664
50	1		Ride Vendetta 50	-		0,50	BR8HSA	5539	-	BR8HIX	7001
50	1		Roc 50, Toxic 50	-		0,70	BR7ES	5122	-	BR7EIX	6664
50	1		Trigger SM / X50	07-		0,70	BR7ES	5122	-	BR7EIX	6664
50			Trigger SM/X Competition Full Power	-		0,70	BR9ES	5722	02	BR9EIX	3981
50	1		Twister 50	-		0,70	BR7ES	5122	-	BR7EIX	6664
50	1		Vendetta 50	-		0,50	BR8HSA	5539	-	BR8HIX	7001
50	1		XOR 50	-		0,70	BR7ES	5122	-	BR7EIX	6664
125	1		Explorer Race, Race, Ride Sarrjo, Soho	-		0,70	CR8E	1275	04	CR8EIX	4218
125	1		XOR 125	-		0,50	CR7HSA	4549	07	CR7HIX	7544
125	1		Zion125	-		0,70	CR8E	1275	04	CR8EIX	4218
150	1		Soho 150	-		0,70	CR8E	1275	04	CR8EIX	4218

GILERA

CYL. Nb Cyl. TYPE MODÈLE



INFO



N° STOCK

N° BLISTER



N° STOCK IX



GILERA

50	1		Eaglet 50	-	0,50	B9ES	2611	02	BR9EIX	3981
50	1		Easy Mooving	95-	0,50	B9ES	2611	02	BR9EIX	3981
50	1		Ice	02-	0,60	B9ES	2611	02	BR9EIX	3981
50			Jetrunner	03-	0,80	CPR8E	7411	-	-	-
50			Pure Jet 50 Direct Injection 2T	04-	0,80	CPR8E	7411	-	-	-
50	1		Runner	97-	0,60	B9EG	3530	-	-	-
50	1		Runner 2P 2D	97-	0,60	B9ES	2611	02	BR9EIX	3981
50			Runner 50 2T	97-	0,60	BR9ES	5722	02	BR9EIX	3981
50			Runner 50 4T	04-	0,80	CPR8E	7411	-	-	-
50	1		Runner FX 125	97-	0,60	B9ES	2611	02	BR9EIX	3981
50	1		Runner PJ	05-	0,60	CPR8E	7411	-	-	-
50	1		Runner Pure Jet Injection	03-05	0,60	CPR8E	7411	-	-	-
50	1		Runner Pure Jet Injection	03-	0,60	ZMR7AP	6914	-	-	-
50	1		Runner Racing Replica	04-	0,60	BR9ES	5722	02	BR9EIX	3981
50	1		Runner RST 50	05-	0,50	B9ES	2611	02	BR9EIX	3981
50	1		Runner SP	00-	0,60	BR9ES	5722	02	BR9EIX	3981
50	1		Stalker	97-99	0,60	B9ES	2611	02	BR9EIX	3981
50	1		Stalker, Storm	00-	0,60	BR9ES	5722	02	BR9EIX	3981
50	1		Storm	94-99	0,60	B9ES	2611	02	BR9EIX	3981
50	1		Typhoon 50	93-	0,60	B9ES	2611	02	BR9EIX	3981
50	1		Zulu Trail	01-	0,60	B9ES	2611	02	BR9EIX	3981
50	1	DD	Runner	97-	0,60	B9EG	3530	-	-	-
50	1	DD	Stalker	97-	0,60	B9ES	2611	02	BR9EIX	3981
50	1	DNA		00-	0,50	B9ES	2611	02	BR9EIX	3981
50	1	GP		02-	0,60	B9EG	3530	-	-	-
50		GSM	Gilera 2T	00-	0,70	BR9ES	5722	02	BR9EIX	3981
50		H@K	Gilera 2T	00-	0,70	BR9ES	5722	02	BR9EIX	3981
50		RCR	Moteur Derbi 2T	04-	0,50	BR9ES	5722	02	BR9EIX	3981
50	1	RCR	4 Temps	06-	0,70	PMR7A	4259	-	-	-
50	1	RK		-	0,50	B9ES	2611	02	BR9EIX	3981
50			SKP	97-	0,50	BR9ES	5722	02	BR9EIX	3981
50			SMT	05-	0,60	BR9ES	5722	02	BR9EIX	3981
50	1	SMT	4 Temps	06-	0,70	PMR7A	4259	-	-	-
50	1	SP	Runner	97-	0,60	B9EG	3530	-	-	-
125	1		Cougar	01-	0,90	DPR8EA-9	4929	08	DPR8EIX-9	2202
125			Crono, Freestyle 2T	-	0,60	B10EG	3630	-	-	-
125	1		Nexus ie	07-	0,60	CR8EB	7784	04	CR8EIX	4218
125	1		TG1, GR1	-	0,50	B7ES	1111	-	BR7EIX	6664
125	1		Typhoon	95-	0,60	B9ES	2611	02	BR9EIX	3981
125		CX	Apache	-	0,60	B10EG	3630	-	-	-
125	1	DD	Runner	97-00	0,50	B9EG	3530	-	-	-
125	1	DNA	4 Temps	00-	0,70	CR9EB	6955	06	CR9EIX	3521
125	1	FX	Runner	97-00	0,50	B9EG	3530	-	-	-
125		GFR		-	0,60	-	-	-	BR10EIX	6801
125		SC	2T	06-	0,70	BR8ES	5422	05	BR8EIX	5044
125		SC	Moteur Yamaha 4T	07-	0,70	BR8ES	5422	05	BR8EIX	5044
125	1	SP	Runner 2 Temps	97-00	0,50	B9EG	3530	-	-	-
125	1		Runner RST / ST	05-	0,70	CR8EB	7784	04	CR8EIX	4218
125	1		Runner VX 4 Temps	01-	0,70	CR9EB	6955	06	CR9EIX	3521
125	1		Runner VX	06-	0,70	CR8EB	7784	04	CR8EIX	4218
150	1		Runner	98-	0,60	BR9ES	5722	02	BR9EIX	3981
180	1	DNA	Leader 4 Temps	00-	0,70	CR9EB	6955	06	CR9EIX	3521
180			Runner FXR 2T	98-	0,60	BR9ES	5722	02	BR9EIX	3981
180	1		Runner VXR 4 Temps	01-	0,70	CR9EB	6955	06	CR9EIX	3521
200	1		Runner ST	08-	0,70	CR8EB	7784	04	CR8EIX	4218
200	1		Runner VXR 4 Temps	02-08	0,70	CPR8E	7411	-	-	-
300	1		Nexus	09-	0,70	CR8EKB	4374	-	CR8EIX	4218
250	1		Nexus ie	07-	0,70	PMR8B	6378	-	-	-
250			Nexus SP	06-	0,60	CR8EB	7784	04	CR8EIX	4218
350			Dakota (4-Stroke)	-	0,60	DPR8EA-9	4929	08	DPR8EIX-9	2202
350			Saturno (4-Stroke)	90-	0,60	DPR8EA-9	4929	08	DPR8EIX-9	2202
500			Dakota (4-Stroke)	-	0,60	DPR8EA-9	4929	08	DPR8EIX-9	2202
500	1		Fuoco ie	07-	0,60	CR7EKB	4455	-	CR7EIX	7385
500	1		Nexus ie - Mot. Piaggio	04-05	0,60	CR7EKB	4455	-	CR7EIX	7385
500	1		Saturno	-	0,90	DP9EA-9	6629	-	DPR8EIX-9	5545
600	1		Nordwest	-	0,70	DCPR8E	4339	-	DCPR8EIX	6546
600			Supersport	02-	0,60	CR9E	6263	06	CR9EIX	3521
600		FB	Nordcape	92-	0,80	D8EA	2120	11	DR8EIX	6681
600		RC	C	92-	0,80	D8EA	2120	11	DR8EIX	6681
800	2	GP	800	07-	0,70	CR7EKB	4455	-	CR7EIX	7385



GILERA-Quad





250	1	Oregon	07-	0,60	CR8EB	7784	04	CR8EIX	4218
-----	---	--------	-----	------	-------	------	----	--------	------



HARLEY DAVIDSON

883	2	Tous modèles	85-	0,90	DCPR7E	3932	-	DCPR7EIX	6046
883	2	Sportster	95-03	0,90	DPR7EA-9	5129	13	DPR7EIX-9	7803
883	2	Sportster	04-	1,00	DCPR7E	3932	-	DCPR7EIX	6046
883	2	Sportster Deluxe	86-89	0,90	DPR7EA-9	5129	13	DPR7EIX-9	7803
883	2	Sportster Iron	09-	0,90	DCPR7EA-9	6651	-	-	-
883	2	Sportster Low	04-	0,90	DCPR7EA-9	6651	-	-	-
883	2	Sportster R	02-04	0,90	DPR7EA-9	5129	13	DPR7EIX-9	7803
883	2	XL R Sports	02-	0,90	DCPR7E	3932	-	DCPR7EIX	6046
883	2	XL C / L / R Sporster / Custom	07-	1,00	DCPR7E	3932	-	DCPR7EIX	6046
1130	2	VRSCA V-Rod	02-	0,90	DPR9EA-9	5329	-	DPR9EIX-9	5545
1130	2	VRSCA Night-Rod	06-	0,60	DCPR9E	2641	-	DCPR9EIX	2316
1130	2	VRSCX	07-	1,00	DCPR7E	3932	-	DCPR7EIX	6046
1130	2	VRSCDX Night Rod Special	07-	1,00	DCPR7E	3932	-	DCPR7EIX	6046
1130	2	VRSC V-Rod, Night Rod, Street Rod	02-	0,90	DCPR8E	4339	-	DCPR8EIX	6546
1200	2	Evolution	88-	0,90	DPR7EA-9	5129	13	DPR7EIX-9	7803
1200	2	Sporster Custom	04-	1,00	DCPR7E	3932	-	DCPR7EIX	6046
1200	2	XL C Sportster Custom	96-	1,00	DCPR7E	3932	-	DCPR7EIX	6046
1200	2	XL L Sportster / Low / R Sportster	07-	1,00	DCPR7E	3932	-	DCPR7EIX	6046
1200	2	XL S Sportster Sport	96-	1,00	DCPR7E	3932	-	DCPR7EIX	6046
1200	2	XLH Sportster	92-99	1,00	DCPR7E	3932	-	DCPR7EIX	6046
1200	2	XR	07-08	1,00	DCPR7E	3932	-	DCPR7EIX	6046
1200	2	XR	08-	0,90	DCPR8E	4339	-	DCPR8EIX	6546
1200	2	XR X	10-	0,90	DCPR8E	4339	-	DCPR8EIX	6546
1250	2	VRSC V-Rod Muscle, 10th Anniversary	10-	0,90	DCPR8E	4339	-	DCPR8EIX	6546
1250	2	VRSC Nighth Rod Special	08-	0,90	DCPR8E	4339	-	DCPR8EIX	6546
1250	2	VRSCS Screamin' Eagle V-Rod	04-	0,60	DCPR9E	2641	-	DCPR9EIX	2316
1340	2	Evolution	84-	1,10	BPR5ES-11	4424	-	BPR5EIX-11	2115
1340	2	FKDWG Dyna Wide Glide	-	0,80	BPR5ES	7422	-	BPR5EIX	6597
1340	2	FLHR Electra Glide Road King	94-	0,80	BPR5ES	7422	-	BPR5EIX	6597
1340	2	FLHR Electra Glide Road King Inj.	96-	1,10	BPR5ES-11	4424	-	BPR5EIX-11	2115
1340	2	FLHRCi Road King Classic side car	-	0,80	BPR5ES	7422	-	BPR5EIX	6597
1340	2	FLHRCi Road King Classic inj.	96-	1,10	BPR5ES-11	4424	-	BPR5EIX-11	2115
1340	2	FLHT Electra Glide Standard	-	0,80	BPR5ES	7422	-	BPR5EIX	6597
1340	2	FLHTC Electra Glide Classic	-	0,80	BPR5ES	7422	-	BPR5EIX	6597
1340	2	FLHTCi Electra Glide Classic inj.	96-	1,10	BPR5ES-11	4424	-	BPR5EIX-11	2115
1340	2	FLHTCUi Electra Glide Ultra Classic	-	0,80	BPR5ES	7422	-	BPR5EIX	6597
1340	2	FLHTCUi Electra Glide Ultra Classic Inj.	96-	1,10	BPR5ES-11	4424	-	BPR5EIX-11	2115
1340	2	FLSTC Heritage Softail Classic	-	0,80	BPR5ES	7422	-	BPR5EIX	6597
1340	2	FLSTF Fat Boy	-	0,80	BPR5ES	7422	-	BPR5EIX	6597
1340	2	FLSTS Heritage Softail Springer	-	0,80	BPR5ES	7422	-	BPR5EIX	6597
1340	2	FXD Dyna Super Glide	-	0,80	BPR5ES	7422	-	BPR5EIX	6597
1340	2	FXDL Dyna Low Rider	-	0,80	BPR5ES	7422	-	BPR5EIX	6597
1340	2	FXDS Conv Dyna Convertible	-	0,80	BPR5ES	7422	-	BPR5EIX	6597
1340	2	FXE Shovel Head	84-	1,00	ZGR5C	6334	-	-	-
1340	2	FXSB Shovel Head	84-	1,00	ZGR5C	6334	-	-	-
1340	2	FXST Softail Custom	-	0,80	BPR5ES	7422	-	BPR5EIX	6597
1340	2	FXSTS Softail Springer	-	0,80	BPR5ES	7422	-	BPR5EIX	6597
1340	2	FXWG Shovel Head	84-	1,00	ZGR5C	6334	-	-	-
1340	2	TXSTSB Bad Boy	-	0,80	BPR5ES	7422	-	BPR5EIX	6597
1450	2	FLHR Electra Glide Road King	99-03	1,00	DCPR7E	3932	-	DCPR7EIX	6046
1450	2	FLHRCi Road King Classic side car	99-03	1,00	DCPR7E	3932	-	DCPR7EIX	6046
1450	2	FLHRCi Road King Classic inj.	99-03	1,00	DCPR7E	3932	-	DCPR7EIX	6046
1450	2	FLHT Electra Glide Standard	99-03	1,00	DCPR7E	3932	-	DCPR7EIX	6046
1450	2	FLHTCUi Electra Glide Ultra Classic Inj.	99-03	1,00	DCPR7E	3932	-	DCPR7EIX	6046
1450	2	FLSTC Héritage Softail Classic	99-03	1,00	DCPR7E	3932	-	DCPR7EIX	6046
1450	2	FLSTCi Héritage Softail Classic inj.	99-03	1,00	DCPR7E	3932	-	DCPR7EIX	6046
1450	2	FLSTS Fat Boy	99-03	1,00	DCPR7E	3932	-	DCPR7EIX	6046
1450	2	FLSTSi Fat Boy inj.	99-03	1,00	DCPR7E	3932	-	DCPR7EIX	6046
1450	2	FXD Dyna Super Glide	99-03	1,00	DCPR7E	3932	-	DCPR7EIX	6046
1450	2	FXDL Dyna Low Rider	99-03	1,00	DCPR7E	3932	-	DCPR7EIX	6046
1450	2	FXDWG Dyna Wide Glide	99-03	1,00	DCPR7E	3932	-	DCPR7EIX	6046
1450	2	FXDX Dyna Super Glide Sport	99-03	1,00	DCPR7E	3932	-	DCPR7EIX	6046
1450	2	FXDXT Dyna Super Glide Touring Sport	99-03	1,00	DCPR7E	3932	-	DCPR7EIX	6046
1450	2	FXST Softail	99-03	1,00	DCPR7E	3932	-	DCPR7EIX	6046
1450	2	FXSTB Night Train	99-03	1,00	DCPR7E	3932	-	DCPR7EIX	6046
1450	2	FXSTD Softail Deuce	99-03	1,00	DCPR7E	3932	-	DCPR7EIX	6046
1450	2	FXSTDi Softail Deuce inj.	99-03	1,00	DCPR7E	3932	-	DCPR7EIX	6046

HARLEY DAVIDSON

CYL.	Nb Cyl.	TYPE	MODÈLE		INFO			N° STOCK	N° BLISTER		N° STOCK IX
1450	2	FXSTS	Softail Springer	99-03		1,00	DCPR7E	3932	-	DCPR7EIX	6046
1584			Blackline	11-		0,90	DCPR8E	4339	-	DCPR8EIX	6546
1584	2		CVO Fat Bob	09-		0,90	DCPR8E	4339	-	DCPR8EIX	6546
1584	2		Dyna Wide Glide	09-		0,80	DCPR8E	4339	-	DCPR8EIX	6546
1584	2		Softail Rocker	08-		0,90	DCPR8E	4339	-	DCPR8EIX	6546
1584			Twin Cam 96B Models	06-		0,90	DCPR8E	4339	-	DCPR8EIX	6546
1584	2	FLHR	Road King	07-		1,00	DCPR7E	3932	-	DCPR7EIX	6046
1584	2	FLHRC	Road King Classic	07-		1,00	DCPR7E	3932	-	DCPR7EIX	6046
1584	2	FLHRS	Road King Custom	07-		1,00	DCPR7E	3932	-	DCPR7EIX	6046
1584	2	FLHT	Electra Glide Standard	07-		1,00	DCPR7E	3932	-	DCPR7EIX	6046
1584	2	FLHTCU	Ultra Classic Electra Glide	07-		1,00	DCPR7E	3932	-	DCPR7EIX	6046
1584	2	FLHX	Street Glide	07-		1,00	DCPR7E	3932	-	DCPR7EIX	6046
1584	2	FLSTC	Heritage Softail	07-		1,00	DCPR7E	3932	-	DCPR7EIX	6046
1584	2	FLSTF	Fat Boy	07-		1,00	DCPR7E	3932	-	DCPR7EIX	6046
1584	2	FLSTN	Softail Deluxe	07-		1,00	DCPR7E	3932	-	DCPR7EIX	6046
1584	2	FLSTSB	Cross Bones	08-		0,90	DCPR8E	4339	-	DCPR8EIX	6546
1584	2	FLSTSC	Softail Springer Classic	07-		1,00	DCPR7E	3932	-	DCPR7EIX	6046
1584	2	FXDB	Dyna Street	07-		1,00	DCPR7E	3932	-	DCPR7EIX	6046
1584	2	FXDC	Dyna Super Glide Custom	07-		1,00	DCPR7E	3932	-	DCPR7EIX	6046
1584	2	FXDL	Dyna Low Rider	07-		1,00	DCPR7E	3932	-	DCPR7EIX	6046
1584	2	FXDWG	Dyna Wide Glide	07-		1,00	DCPR7E	3932	-	DCPR7EIX	6046
1584	2	FXSTB	Night Train	07-		1,00	DCPR7E	3932	-	DCPR7EIX	6046
1584	2	FXSTC	Softail Custom	07-		1,00	DCPR7E	3932	-	DCPR7EIX	6046
1690	2		E-Glide Ultra Limited	10-		0,90	DCPR8E	4339	-	DCPR8EIX	6546
1800	2		CVO / Street / Fat Bob, LTRSE-CVO	09-		0,90	DCPR8E	4339	-	DCPR8EIX	6546



HM RACING





50	1		Six, Baja, Dérapage	97-		0,60	B8ES	2411	05	BR8EIX	5044
50	1	CRX	Junior & Senior	01-		0,60	B8HS	5510	01	BR8HIX	7001
50	1	MX	Junior & Senior	01-		0,60	B8HS	5510	01	BR8HIX	7001



HONDA

50	1		DIO 50	04-		0,70	ER8EH-N	5606	-	ER8EHIX	8201
50	1		Zoomer	05-		0,70	ER8EH-N	5606	-	ER8EHIX	8201
50	1	CB	V Dream 50	98-		0,90	CR8EH-9	5666	10	CR8EHIX-9	3797
50	1	CRF	F	04-		0,70	CR6HSA	2983	-	CR6HIX	7274
50	1	NH	Lead F / H / J	85-		0,70	BPR6HS	7022	-	BPR6HIX	4085
50	1	NH	M	93-		0,70	BPR6HS	7022	-	BPR6HIX	4085
50	1	NS	R	-		0,80	B8ES	2411	05	BR8EIX	5044
50	1	NSC	Vision	12-		0,90	CR7HSA-9	5147	-	CR7HIX	7544
50	1	NSR	A K	89-		0,70	BR9ES	5722	02	BR9EIX	3981
50	1	PK	Wallaro	90-		0,60	BR6HSA	4296	-	BR6HIX	3419
50	1	PX	S	87-		0,70	BPR5HS	6222	-	-	-
50	1	PX		89-90		0,60	BPR5HS	6222	-	-	-
50	1	PXR		87-		0,70	BPR5HS	6222	-	-	-
50	1	RTL	SF	87-		0,80	B8ES	2411	05	BR8EIX	5044
50	1	SFX	S>1	95-		0,70	BR6HSA	4296	-	BR6HIX	3419
50	1	SGX	Sky (V/W)	97-98		0,70	BR6HSA	4296	-	BR6HIX	3419
50	1	SH	H	87-		0,70	BPR6HS	7022	-	BPR6HIX	4085
50	1	SH	New	97-		0,60	BPR6HS	7022	-	BPR6HIX	4085
50	1	SH	P - Scoopy	93-95		0,70	BPR6HSA	4632	-	BPR6HIX	4085
50	1	SH	R - Scoopy	93-		0,70	BPR6HS	7022	-	BPR6HIX	4085
50	1	SH	T - Scoopy	96-		0,70	BR6HSA	4296	-	BR6HIX	3419
50	1	SJ	Baly (P>Y)	93-		0,70	BR6HSA	4296	-	BR6HIX	3419
50	1	SRX	T - Joker	97-99		0,50	BR6HSA	4296	-	BR6HIX	3419
50	1	SRX	Shadow (W/X)	97-99		0,70	BR6HSA	4296	-	BR6HIX	3419
50	1	SXR	W	98-		0,60	BR6HSA	4296	-	BR6HIX	3419
50	1	SZX	X (X8R-X Cross Sport) (W>1)	98-		0,70	BR6HSA	4296	-	BR6HIX	3419
50	1	SZX	S (X8R-S Super Sport) (W>1)	98-		0,70	BR6HSA	4296	-	BR6HIX	3419
50	1	TLM	F	85-		0,80	BR8ES	5422	05	BR8EIX	5044
50	1	XR	R	00-		0,70	CR6HSA	2983	-	CR6HIX	7274
50	1	Z	JJ M	91-		0,70	CR6HS	7023	-	-	-
50	1	ZB	J	88-		0,70	CR6HSA	2983	-	CR6HIX	7274
70	1	CRF	F	04-		0,70	CR6HSA	2983	-	CR6HIX	7274
70	1	ST	Dax (L>T)	90-96		0,70	CR6HSA	2983	-	CR6HIX	7274
70	1	XR	R (V>1)	97-00		0,70	CR6HSA	2983	-	CR6HIX	7274
80	1	CR	R & RB (G>1)	86-		0,60	BR10EG	3830	-	-	-
80	1	MBX	SWD, SW2	85-		0,80	BR9ES	5722	02	BR9EIX	3981
80	1	MT		85-		0,70	BR9HS	4522	-	BR9HIX	5687
80		NH	MD/H-P	82-96		0,70	BPR6HS	7022	-	BPR6HIX	4085
80	1	NH	MS (N/P/R)	92-		0,70	BPR6HS	7022	-	BPR6HIX	4085
80	1	XR	R (M/P/R/S)	91-		0,70	CR7HSA	4549	07	CR7HIX	7544
85	1	CR	RB	03-		0,60	BR10EG	3830	-	-	-

CYL.	Nb Cyl.	TYPE	MODÈLE		INFO			N° STOCK	N° BLISTER		N° STOCK IX
90		C	E-C/E/G, C90MF-T (Step Thru)	84-96		0,70	CR7HS	7223	-	-	-
90		C	MT (Step Thru)	96-03		0,60	CR6HSA	2983	-	CR6HIX	7274
90	1	EZ	Cub (M)	91-		0,70	BR7HS	4122	03	BR7HIX	7067
90	1	SRX	Shadow (W/X)	98-99		0,70	BR6HSA	4296	-	BR6HIX	3419
100	1	CRF	F	04-07		0,90	CR7HSA	4549	07	CR7HIX	7544
100	1	CRF	F	08-		0,70	CR7HSA	4549	07	CR7HIX	7544
100	1	SCV	Lead	03-		0,70	CR6HSA	2983	-	CR6HIX	7274
100	1	SCV	Lead	08-		0,90	CR8EH-9	5666	10	CR8EHIX-9	3797
100	1	SH	T - Scoopy	96-		0,70	BR6HSA	4296	-	BR6HIX	3419
100	1	SJ	EX Baly (T>Y)	96-		0,70	BR6HSA	4296	-	BR6HIX	3419
100	1	XR	R (M>Y)	91-		0,70	CR7HSA	4549	07	CR7HIX	7544
109		AFS	Wave 110i	12-		0,90	CPR6EA-9S	1582	-	-	-
109		CRF	F	12-		0,90	CPR6EA-9S	1582	-	-	-
110	1		Spacy scooter (Refr. liquide) auto.	12-14		0,90	MR8C-9N	97985	-	-	-
110		NHX	WH	08-		0,90	CR7EH-9	3486	-	-	-
110	1	NSC	Vision 4 Temps	11-		0,90	CPR8EA-9	2306	-	-	-
110	1	SCR		13-		0,90	CPR8EA-9	2306	-	-	-
125	1	@		02-		0,80	CR8EH-9	5666	10	CR8EHIX-9	3797
125	1	ANF		04-		0,90	CPR6EA-9	6899	-	-	-
125	1	ANF	Innova, Innova i	07-		0,90	CPR6EA-9	6899	-	-	-
125	2	CA	Rebel (S>Y)	95-		0,70	CR6HSA	2983	-	CR6HIX	7274
125		CB	TD (J)	88-		0,70	CR7HSA	4549	07	CR7HIX	7544
125		CBF		08-		0,90	CPR7EA-9	3901	-	CPR7EAIX-9	9198
125	1	CBR	R, RR	03-		0,60	CR8E	1275	04	CR8EIX	4218
125	1	CBR	RW B-F	11-		0,60	CR8E	1275	04	CR8EIX	4218
125		CG	(N>X)	92-99		0,90	DPR8EA-9	4929	08	DPR8EIX-9	2202
125	1	CH	Spacy (N/P/R/T)	92-		0,90	DPR7EA-9	5129	13	DPR7EIX-9	7803
125		CLR	CityFly (X/Y)	98-		0,90	DPR8EA-9	4929	08	DPR8EIX-9	2202
125		CM	C Custom (N/P/R)	92-		0,70	CR7HSA	4549	07	CR7HIX	7544
125	1	CR	R (H>V)	87-97		0,60	BR9EG	3230	-	-	-
125	1	CR	R Cadre alu (W/X/Y/1)	97-		0,60	BR9EG	3230	-	-	-
125	1	CR	R (ED)	01-		0,60	BR9EG	3230	-	-	-
125	1	CR	R	05-		0,60	BR9EG	3230	-	-	-
125		CRM	R (L>Y)	90-00		0,70	BR9ECS	3570	-	-	-
125	1	F5	Dylan	02-		0,80	CR8EH-9	5666	10	CR8EHIX-9	3797
125	1	FES	Pantheon (W/X/Y/1) 2 temps	98-		0,70	BR8ES	5422	05	BR8EIX	5044
125	1	FES	Pantheon 2 (4 temps)	03-		0,80	CR8EH-9	5666	10	CR8EHIX-9	3797
125		FES	AB-F Silver Wing ABS	11-		0,90	CR8EH-9	5666	10	CR8EHIX-9	3797
125		MTX	R2 (H)	87-		0,80	BR8ES	5422	05	BR8EIX	5044
125		NES	Y / ES (1)	00-		0,90	CR8EH-9	5666	10	CR8EHIX-9	3797
125		NH		-		0,70	BR6HS	3922	09	BR6HIX	3419
125		NS	R	-		0,80	BR9ES	5722	02	BR9EIX	3981
125		NSR	R2 (H)	87-		0,80	BR7ES	5122	-	BR7EIX	6664
125		NSR	R (K>1)	89-		0,70	BR9ECS	3570	-	-	-
125		NX	Transcity (K>W)	89-98		0,70	DR8ES	5423	11	DR8EIX	6681
125	1	PCX		10-11		0,90	CPR7EA-9	3901	-	CPR7EAIX-9	9198
125	1	PCX	Auto.	12-		0,90	MR8C-9N	97985	-	-	-
125	1	PS	i	06-		0,90	CR8EH-9	5666	10	CR8EHIX-9	3797
125		RS	R	01-		0,60	R7376-10	4457	-	-	-
125		SES	Dylan	02-		0,90	CR8EH-9	5666	10	CR8EHIX-9	3797
125	1	SH	Scoopy	01-		0,90	CR8EH-9	5666	10	CR8EHIX-9	3797
125	1	SH	i / Sport / Special	05-		0,90	CR8EH-9	5666	10	CR8EHIX-9	3797
125		SH	B-F Injection Disque	11-		0,90	CR8EH-9	5666	10	CR8EHIX-9	3797
125		SH	i	13-		0,90	CPR7EA-9	3901	-	CPR7EAIX-9	9198
125		VT	C Shadow	99-		0,90	CR8EH-9	5666	10	CR8EHIX-9	3797
125		XL	VB-3E Varadero De Luxe, VB-EU Varadero	11-		0,90	CR8EH-9	5666	10	CR8EHIX-9	3797
125	2	XLV	Varadero	01-		0,90	CR8EH-9	5666	10	CR8EHIX-9	3797
125		XLR		-97		0,70	DR8ES-L	2923	-	DR8EIX	6681
125		XLR	R (W/X)	97-99		0,90	DPR8EA-9	4929	08	DPR8EIX-9	2202
125		XR	L	03-		0,90	DPR8EA-9	4929	08	DPR8EIX-9	2202
150	1	CRF	R/R2	07-		0,90	CR8EH-9	5666	10	CR8EHIX-9	3797
150	1	CRF	RB	07-09		0,90	CR8EH-9	5666	10	CR8EHIX-9	3797
150	1	CRF	F / R	06-		0,90	CPR8EA-9	2306	-	-	-
150	1	FES	S-Wing ABS	07-		0,90	CR8EH-9	5666	10	CR8EHIX-9	3797
150	1	SH	i / Sport / Special	06-		0,90	CR8EH-9	5666	10	CR8EHIX-9	3797
230	1	CRF	F	08-		0,80	DPR8EA-9	4929	08	DPR8EIX-9	2202
250			Jazz	02-		0,90	DPR7EA-9	5129	13	DPR7EIX-9	7803
250	1		Forza	05-07		0,90	DPR7EA-9	5129	13	DPR7EIX-9	7803
250	1		Forza ABS	08-		0,90	LMAR8A-9	4313	-	-	-
250		CB	R	94-		0,70	CR6HSA	2983	-	CR6HIX	7274
250		CBF		06-		0,90	CR8EH-9	5666	10	CR8EHIX-9	3797
250		CBR	R, RB-2-F/3F	11-		0,90	SIMR8A9	91064	-	-	-
250		CD	U	-		0,70	CR6HSA	2983	-	CR6HIX	7274
250		CMX	C Rebel (T/V)	96-99		0,70	CR6HSA	2983	-	CR6HIX	7274
250	1	CN		86-		0,90	DPR6EA-9	5531	-	-	-

CYL.	Nb Cyl.	TYPE	MODÈLE		INFO			N° STOCK	N° BLISTER		N° STOCK IX
250	1	CN	Fusion	-		0,90	DPR8EA-9	4929	08	DPR8EIX-9	2202
250	1	CN	Helix	87-99		0,90	DPR6EA-9	5531	-	-	-
250	1	CN	Spacy	-		0,90	DPR6EA-9	5531	-	-	-
250	1	CN	Spazio (J>V)	88-97		0,90	DPR6EA-9	5531	-	-	-
250		CR	R (K>1)	89-		0,60	BR8EG	3130	-	-	-
250		CR	R (ED)	01-		0,60	BR8EG	3130	-	-	-
250	1	CR	RK5	05-		0,80	BR9EG-N8	2689	-	-	-
250	1	CR	R 2 Temps	05-		0,60	BR9EG	3230	-	-	-
250	1	CRF	F	04		0,70	R0409B-8	7791	-	-	-
250	1	CRF	X	03-07		0,90	IMR8C-9H	3653	-	-	-
250	1	CRF	R	04		0,90	IMR8C-9H	3653	-	-	-
250	1	CRF	R	05-07		0,70	R0409B-8	7791	-	-	-
250	1	CRF	R	08-09		0,70	R0409B-8	7791	-	-	-
250	1	CRF	R	10-		0,70	R0451B-8	9356	-	-	-
250	1	FES	Foresight (W/X/Y)	97-		0,90	DPR7EA-9	5129	13	DPR7EIX-9	7803
250	1	NSF	R	-		1,00	R0451C-10	92278	-	-	-
250		NX	II (P>V)	93-97		0,90	CR9EH-9	7502	-	CR9EHIX-9	6216
250		RS	R	01-		0,60	R7282-105	4985	-	-	-
250		RTL	S	85-		0,60	D6EA	7512	-	-	-
250		TLM	R	88-		0,80	B6ES	7310	-	-	-
250		TLR	F	88-		0,90	DPR6EA-9	5531	-	-	-
250		XR	L	92-		0,70	DPR8Z	4730	-	-	-
250	1	XR	R (E>S)	84-95		0,70	DPR9Z	4830	-	-	-
250	1	XR	R (T>Y)	96-		0,90	CR9EH-9	7502	-	CR9EHIX-9	6216
260	1	CRF	L (D/E/F) & M (E/F)	13-15		0,90	SIMR8A9	91064	-	-	-
300	1	SH	AB-F	11-		0,90	LMAR8A-9	4313	-	-	-
300	1	SH	i / Sport / ABS	07-10		0,90	LMAR8A-9	4313	-	-	-
400	2	FJS	Silverwing	06-		0,90	CR8EH-9	5666	10	CR8EHIX-9	3797
400		SW-T		09-		0,90	CR8EH-9	5666	10	CR8EHIX-9	3797
400		VFR	R (M)	91-		0,70	ER9EH	5869	-	ER9EHIX	96652
400	1	XR	R (T>1)	96-		0,70	DPR8Z	4730	-	-	-
400	1	XR	R Monnier	99-		0,70	DPR8Z	4730	-	-	-
450		CB	S (G/J)	86-		0,70	DR8ES-L	2923	-	DR8EIX	6681
450	1	CRF	R (ED)	02-		1,10	IFR8H11	5068	-	-	-
450	1	CRF	4 Temps	05-		1,10	IFR9H11	6588	-	-	-
450	1	CRF	4 Temps	09-		0,90	SILMAR9A9S	6213	-	-	-
450	1	CRF	R 4 Temps - Conduite Sportive	09-		0,90	SILMAR10A9S	7764	-	-	-
500		CB	(R>Y)	94-		0,90	CR8EH-9	5666	10	CR8EHIX-9	3797
500		CB	S (W>Y)	98-		0,90	CR8EH-9	5666	10	CR8EHIX-9	3797
500	2	CBF	N / NA	04-06		0,90	CR8EH-9S	7750	-	-	-
600			Silver Wing	11-		0,90	IMR9C-9HES	5766	-	-	-
600	4	CB	F Hornet, S (W/X/Y/1)	98-		0,90	CR9EH-9	7502	-	CR9EHIX-9	6216
600	4	CB	Hornet N	05-		0,90	CR9EH-9	7502	-	CR9EHIX-9	6216
600	4	CB	F Hornet	11-		0,90	CR8EH-9	5666	10	CR8EHIX-9	3797
600	4	CB	RR	09-		0,90	IMR9E-9HES	7556	-	-	-
600	4	CBF	S / N	04-06		0,90	CR9EH-9	7502	-	CR9EHIX-9	6216
600		CBF	S / N	08-		0,90	CR8EH-9	5666	10	CR8EHIX-9	3797
600		CBR	F / F2 / F3 (M>W) / F (X/Y)	91-00		0,90	CR9EH-9	7502	-	CR9EHIX-9	6216
600	4	CBR	F / FS (1)	01-03		0,90	IMR9A-9H	6966	-	-	-
600	4	CBR	Hannspree	08-		0,90	IMR9C-9H	6777	-	-	-
600	4	CBR	RR	03-04		0,90	IMR9C-9H	6777	-	-	-
600	4	CBR	RR	05-06		0,90	IMR9C-9HES	5766	-	-	-
600	4	CBR	RR	08-		0,90	IMR9C-9H	6777	-	-	-
600		CBR	RRAB-F/2F/3F ABS	11-		0,90	IMR9C-9HES	5766	-	-	-
600	4	CBR	RR / ABS 600	09-		0,90	IMR9E-9HES	7556	-	-	-
600	2	FES	Silver Wing	01-		0,90	CR8EH-9	5666	10	CR8EHIX-9	3797
600	2	FJSB	Silver Wing ABS	03-		0,90	CR8EH-9	5666	10	CR8EHIX-9	3797
600		VT	C Shadow (J>Y)	88-		0,90	DPR8EA-9	4929	08	DPR8EIX-9	2202
600		XL	V Transalp (H>X)	86-99		0,90	DPR8EA-9	4929	08	DPR8EIX-9	2202
600	1	XR	R (P>X)	93-99		0,90	DPR8EA-9	4929	08	DPR8EIX-9	2202
650	2		Transalp	05-		0,90	DPR8EA-9	4929	08	DPR8EIX-9	2202
650	1	FMX		05-		0,90	DPR8EA-9	4929	08	DPR8EIX-9	2202
650		FX	X / Y	99-		0,90	DPR8EA-9	4929	08	DPR8EIX-9	2202
650		NTV	J>V	88-98		0,90	DPR8EA-9	4929	08	DPR8EIX-9	2202
650	2	NTV	Deauville (W/X/Y/1)	98-02		0,90	DPR8EA-9	4929	08	DPR8EIX-9	2202
650	2	NTV	Deauville (ED)	02-		0,90	DPR8EA-9	4929	08	DPR8EIX-9	2202
650		NX	Dominator (J>Y)	88-		0,90	DPR8EA-9	4929	08	DPR8EIX-9	2202
650		SLR	V / W	97-98		0,90	DPR8EA-9	4929	08	DPR8EIX-9	2202
650	2	XLV	Transalp (Y/1)	00-07		0,90	DPR8EA-9	4929	08	DPR8EIX-9	2202
650	1	XR	L	93-96		0,90	DPR8EA-9	4929	08	DPR8EIX-9	2202
650	1	XR	R (Y/1)	00-		1,10	BKR7E-11	1283	-	BKR7EIX-11	6988
680	2		DN-01	09-		0,90	CPR8EA-9	2306	-	-	-
680	2		DN-01	10-		0,90	SIMR8A9	91064	-	-	-
680	2	NT	Deauville	06-		0,90	CPR8EA-9	2306	-	-	-
700	2		Transalp	08-		0,90	CPR8EA-9	2306	-	-	-

CYL.	Nb Cyl.	TYPE	MODÈLE		INFO			N° STOCK	N° BLISTER		N° STOCK IX
700	2	NC	D / S / SA / SD			1,10	IFR6G-11K	1314	-	-	-
700	2	NC	X / XA / XD			1,10	IFR6G-11K	1314	-	-	-
700	2	NSA	A			0,90	SIMR8A9	91064	-	-	-
700	2	NSA	DN-01			0,90	SIMR8A9	91064	-	-	-
750	2		Shadow Spirit			0,90	DPR7EA-9	5129	13	DPR7EIX-9	7803
750	2		Shadow 750 RS, Shadow 750 Black Spirit			0,90	DPR8EA-9	4929	08	DPR8EIX-9	2202
750		CB	F2 Seven Fifty (N>X)			0,90	DPR8EA-9	4929	08	DPR8EIX-9	2202
750		NR	N			0,70	ER9EH	5869	-	ER9EHIX	96652
750		RVF	R (RC45) (R>V)			0,90	-	-	-	CR9EHIX-9	6216
750		VF	C Magna (RC43) (P>V)			0,90	CR8EH-9	5666	10	CR8EHIX-9	3797
750		VFR	F (R>V)			0,90	CR9EH-9	7502	-	CR9EHIX-9	6216
750		VFR	R (RC 30) (J/K)			0,90	CR9EH-9	7502	-	CR9EHIX-9	6216
750	2	VT	C (V>Y)			0,90	DPR8EA-9	4929	08	DPR8EIX-9	2202
750	2	VT	C			0,90	DPR7EA-9	5129	13	DPR7EIX-9	7803
750	2	VT	C2 Shadow (X/Y)			0,90	DPR8EA-9	4929	08	DPR8EIX-9	2202
750	2	VT	DC Black Widow (I)			0,90	DPR8EA-9	4929	08	DPR8EIX-9	2202
750	2	VT	DCA, DCB Shadow Spirit			0,90	DPR8EA-9	4929	08	DPR8EIX-9	2202
750	2	VT	Shadow RS / S			0,90	DPR7EA-9	5129	13	DPR7EIX-9	7803
750		VT	C2B Shadow			0,90	DPR7EA-9	5129	13	DPR7EIX-9	7803
750		XLV	R F			0,90	DPR8EA-9	4929	08	DPR8EIX-9	2202
750	2	XRV	Africa Twin			0,90	DPR8EA-9	4929	08	DPR8EIX-9	2202
800		PC	K			0,90	DPR7EA-9	5129	13	DPR7EIX-9	7803
800	4	VFR	Fi (W/X/Y/1)			0,90	CR9EH-9	7502	-	CR9EHIX-9	6216
800	4	VFR	X			0,90	IMR9D-9H	6544	-	-	-
800	4	VFR	Fi V4 VTEC (ED)			0,90	IMR9B-9H	4888	-	-	-
900		CBR				0,90	IMR9C-9HES	5766	-	-	-
919	4	CB	F Homet (ED)			0,90	CR8EH-9	5666	10	CR8EHIX-9	3797
919		CBR	RR FireBlade (N>X)			0,90	CR9EH-9	7502	-	CR9EHIX-9	6216
929	4	CBR	RR FireBlade (Y)			0,90	CR9EHI-9	6419	-	-	-
929	4	CBR	RR FireBlade (1)			0,90	IMR9A-9H	6966	-	-	-
954	4	CBR	RR FireBlade (ED)			0,90	IMR9C-9H	6777	-	-	-
1000	2		Varadéro			0,90	IJR8B9	4873	-	-	-
1000		CB	F Big One (P>X)			0,90	DPR9EA-9	5329	-	DPR9EIX-9	5545
1000	4	CB	RA			0,90	IMR9E-9HES	7556	-	-	-
1000	4	CB	RR Fireblade			0,90	IMR9C-9HES	5766	-	-	-
1000	4	CB	R			0,90	IMR9E-9HES	7556	-	-	-
1000	4	CBF				0,90	CR8EH-9	5666	10	CR8EHIX-9	3797
1000	4	CBF	F, FA			0,90	IMR8C-9HES	5990	-	-	-
1000	4	CBR	RR / Fireblade / Repsol			0,90	IMR9C-9HES	5766	-	-	-
1000	4	CBR	RR			0,90	IMR9C-9H	6777	-	-	-
1000	4	CBR	RR			0,90	IMR9E-9HES	7556	-	-	-
1000		CBR	RAB-2F / RAB-3F			0,90	IMR9E-9HES	7556	-	-	-
1000		VF	F2 (F)			0,90	DPR9EA-9	5329	-	DPR9EIX-9	5545
1000		VTR	F Firestorm (V/W/X/Y/1)			0,90	-	-	-	DPR9EIX-9	5545
1000	2	VTR	SP-1 (Y/1)			1,10	FR9BI-11	4709	-	-	-
1000	2	VTR	SP-2 (ED)			1,10	IFR9H11	6588	-	-	-
1000		XLV	Varadero (X/Y/1/2)			0,90	-	-	-	DPR8EIX-9	2202
1000		XLV	Varadero (3/4/5/6/7)			0,90	IJR8B9	4873	-	-	-
1100		CB				0,90	LMAR8A-9S	6817	-	-	-
1100		CB	SF X-11 (Y/1), X-Eleven			0,90	-	-	-	CR8EHIX-9	3797
1100		CBR	XX Fi Super Blackbird (V>Y)			0,90	-	-	-	CR9EHIX-9	6216
1100	4	CBR	XX Fi Super Blackbird (1)			0,90	IMR9A-9H	6966	-	-	-
1100	4	CBR	XX			0,90	IMR9C-9H	6777	-	-	-
1100	4	ST	Pan-European (L>Y)			0,90	CR8EH-9	5666	10	CR8EHIX-9	3797
1100		VT	C			0,90	DPR7EA-9	5129	13	DPR7EIX-9	7803
1100		VT	C (R/S)			0,90	DPR7EA-9	5129	13	DPR7EIX-9	7803
1100		VT	C2 (S) / C2 B ACE (T>Y)			0,90	DPR7EA-9	5129	13	DPR7EIX-9	7803
1100		VT	C3, AERO (W)			0,90	DPR7EA-9	5129	13	DPR7EIX-9	7803
1200	4	VFR	F			0,90	IMR9E-9HES	7556	-	-	-
1200	4	VFR				0,90	IMR8E-9HES	95397	-	-	-
1200	4	VFR	V4 / V4 Tourer			0,90	IMR9E-9HES	7556	-	-	-
1200	4	VFR	X Crosstourer 1200			0,90	IMR8E-9HES	95397	-	-	-
1300	4	CB	ABS, S			0,90	DPR8EA-9	4929	08	DPR8EIX-9	2202
1300	4	CB	F Super Four			0,90	DPR9EA-9	5329	-	DPR9EIX-9	5545
1300	4	CB	Super Touring			0,90	DPR9EA-9	5329	-	DPR9EIX-9	5545
1300	4	ST	Pan-European (ED)			0,90	CR7EH-9	3486	-	-	-
1300	2	VT	CX			0,80	DCPR6E	3481	-	DCPR6EIX	8196
1300	2	VT	CXA			0,90	DCPR6E	3481	-	DCPR6EIX	8196
1300	2	VTX	S			0,90	DCPR6E	3481	-	DCPR6EIX	8196
1500	6	GL	A, SE (N>Y)			0,90	DPR7EA-9	5129	13	DPR7EIX-9	7803
1500	6	GL	C F6C (V>1)			0,90	DPR7EA-9	5129	13	DPR7EIX-9	7803
1800	6	GL	Gold Wing (1>7)			1,10	BKR6E-11	2756	-	BKR6EIX-11	3764
1800	6	GL	Gold Wing			1,10	BKR6E-11	2756	-	BKR6EIX-11	3764
1800	6	GL				1,10	BKR6E-11	2756	-	BKR6EIX-11	3764
1800	6	VTX	C			1,10	IFR6L11	3678	-	-	-

HONDA - Quad

CYL. Nb Cyl. TYPE MODÈLE



INFO



N° STOCK

N° BLISTER



N° STOCK IX



HONDA - Quad

70	1	TRX	H 4x2	87-	0,70	CR7HSA	4549	07	CR7HIX	7544
90	1		Fourtrax	08-	0,70	CR7HSA	4549	07	CR7HIX	7544
90	1	TRX	(4x2)	02-	0,70	CR7HSA	4549	07	CR7HIX	7544
90	1	TRX	X	09-	0,70	CR7HSA	4549	07	CR7HIX	7544
125	1		Trax	-	0,70	DR8ES-L	2923	-	DR8EIX	6681
200	1	TRX	D (S/T/V)	95-97	0,70	DR8ES-L	2923	-	DR8EIX	6681
200	1	TRX	M	91-	0,70	DR8ES-L	2923	-	DR8EIX	6681
250			Fourtrax	08-	0,90	DPR8EA-9	4929	08	DPR8EIX-9	2202
250	1	FL		-	0,80	BR9ES	5722	02	BR9EIX	3981
250	1	TRX		-	0,60	DR8ES-L	2923	-	DR8EIX	6681
250		TRX	1-U (4x2)	-01	0,90	DPR8EA-9	4929	08	DPR8EIX-9	2202
250		TRX	EX (4x2), Fourtrax (4x2)	02-	0,90	DPR8EA-9	4929	08	DPR8EIX-9	2202
250		TRX	H	87-	0,70	DR8ES-L	2923	-	DR8EIX	6681
250		TRX	TE	03-	0,90	DPR8EA-9	4929	08	DPR8EIX-9	2202
250		TRX	TM (4x2)	-00	0,90	DPR8EA-9	4929	08	DPR8EIX-9	2202
250		TRX	V/W/X/Y/1 4x2	97-	0,90	DPR8EA-9	4929	08	DPR8EIX-9	2202
300		TRX		09-	0,70	DR8ES-L	2923	-	DR8EIX	6681
300		TRX	(>Y) (4x2)	-01	0,90	DPR8EA-9	4929	08	DPR8EIX-9	2202
300	1	TRX	EX	93-	0,60	DR8ES-L	2923	-	DR8EIX	6681
300		TRX	EX Sportrax	06-	0,70	DR8ES-L	2923	-	DR8EIX	6681
300	1	TRX	FW (J>Y) (4x4)	-01	0,90	DPR8EA-9	4929	08	DPR8EIX-9	2202
300	1	TRX	N	92-	0,90	DPR8EA-9	4929	08	DPR8EIX-9	2202
350	1	ATC	X	-	0,70	DR8ES-L	2923	-	DR8EIX	6681
350	4	FL	R	-	0,80	BR9ES	5722	02	BR9EIX	3981
350	1	TRX		93-	0,60	DR8ES-L	2923	-	DR8EIX	6681
350		TRX	FE (4x4), FM (4x4) Manuel / Electrique	01-	0,90	DPR7EA-9	5129	13	DPR7EIX-9	7803
350		TRX	TE	05-	0,90	DPR7EA-9	5129	13	DPR7EIX-9	7803
350		TRX	TM (4x2)	01-	0,90	DPR7EA-9	5129	13	DPR7EIX-9	7803
400		TRX	EX Fourtrax (4x2)	99-	0,70	DPR8Z	4730	-	-	-
400		TRX	FA, FGA	04-	0,90	DPR8EA-9	4929	08	DPR8EIX-9	2202
400		TRX	FW Foreman (4x2)	96-	0,80	DPR7EA-9	5129	13	DPR7EIX-9	7803
400		TRX		09-	0,70	DPR8Z	4730	-	-	-
420	1	TRX	FA / FE / FM / FPA / FPM / TA / TE	10-	1,10	BKR5E-11	6953	-	BKR5EIX-11	5464
420		TRX	FE	08-	1,10	BKR5E-11	6953	-	BKR5EIX-11	5464
450		TRX	ER	06-	1,10	IFR8H11	5068	-	-	-
450		TRX	ES	04-	0,90	DPR7EA-9	5129	13	DPR7EIX-9	7803
450		TRX	ESW Foreman (4x4)	98-	0,80	DPR7EA-9	5129	13	DPR7EIX-9	7803
450		TRX	FE	02-	0,90	DPR7EA-9	5129	13	DPR7EIX-9	7803
500		TRX	FA Rubicon (4x4)	01-	0,90	IJR7A9	7901	-	-	-
650	1	TRX	FA / FGA / Rincon	05-	1,10	IFR5L11	6502	-	-	-
680	1	TRX	FA	10-	1,10	IFR5L11	6502	-	-	-
680		TRX	FGA Fourtrax Rincon	06-	1,10	IFR5L11	6502	-	-	-
700		TRX		-	1,11	ZFR7F-11	2975	-	-	-







HRD

50	1		Slide Sonic Supermotard	98-	0,60	BR8ES	5422	05	BR8EIX	5044
50	1	GS	Enduro	98-99	0,60	BR8ES	5422	05	BR8EIX	5044
50	1		Sonic 2 Trail & SM	99-	0,60	BR8ES	5422	05	BR8EIX	5044
125	1		Cabriolet Trail & Super Motard	99-	0,70	CR9EB	6955	06	CR9EIX	3521



HUSABERG

125	1	TE		-	0,70	-	-	-	BR7EIX	6664
250		TE		11-	0,70	BR7ES	5122	-	BR7EIX	6664
300		TE		11-	0,70	BR7ES	5122	-	BR7EIX	6664
390	1	FE		10-	0,90	LKAR8AI-9	6706	-	-	-
400	1	FC		-99	0,70	C8E	7471	04	CR8EIX	4218
400	1	FE	E, S	-99	0,70	C8E	7471	04	CR8EIX	4218
400	1	FE	E	99-	0,70	DCPR8E	4339	-	DCPR8EIX	6546
400	1	FS	C / E	99-	0,70	DCPR8E	4339	-	DCPR8EIX	6546
400	1	FX	E	-99	0,70	C8E	7471	04	CR8EIX	4218
400	1	FX		99-	0,70	DCPR8E	4339	-	DCPR8EIX	6546
400	1	SM		99-	0,70	DCPR8E	4339	-	DCPR8EIX	6546
450	1	FE-E		04-	0,70	-	-	-	DCPR8EIX	6546
450	1	FE		09-	0,90	LKAR8AI-9	6706	-	-	-
450	1	FX		99-	0,70	DCPR8E	4339	-	DCPR8EIX	6546
470	1	FC	/ 6	99-	0,70	DCPR8E	4339	-	DCPR8EIX	6546
470	1	FC	e	02-	0,70	DCPR8E	4339	-	DCPR8EIX	6546
470	1	FX	E	99-	0,70	DCPR8E	4339	-	DCPR8EIX	6546
501	1	FC		95-99	0,70	C8E	7471	04	CR8EIX	4218
501	1	FC		99-	0,70	DCPR8E	4339	-	DCPR8EIX	6546





CYL.	Nb Cyl.	TYPE	MODÈLE		INFO			N° STOCK	N° BLISTER		N° STOCK IX
501	1	FE	E, S	93-99		0,70	C8E	7471	04	CR8EIX	4218
501	1	FE	E	99-		0,70	DCPR8E	4339	-	DCPR8EIX	6546
501	1	FE	FE	03-		0,70	-	-	-	DCPR8EIX	6546
501	1	FX	E	-99		0,70	C8E	7471	04	CR8EIX	4218
501	1	FX		99-		0,70	DCPR8E	4339	-	DCPR8EIX	6546
501	1	SM		99-		0,70	DCPR8E	4339	-	DCPR8EIX	6546
550	1	FC	4 / 6	99-		0,70	DCPR8E	4339	-	DCPR8EIX	6546
550	1	FE	E	04-		0,70	-	-	-	DCPR8EIX	6546
565	1		570 FE	09-		0,90	LKAR8AI-9	6706	-	-	-
600	1	FC		92-99		0,70	C8E	7471	04	CR8EIX	4218
600	1	FE	E, S	92-99		0,70	C8E	7471	04	CR8EIX	4218
600	1	FX	E	-99		0,70	C8E	7471	04	CR8EIX	4218
650	1		Elduro Rallye	99-		0,70	DCPR8E	4339	-	DCPR8EIX	6546
650	1	FE	E	99-		0,70	DCPR8E	4339	-	DCPR8EIX	6546
650	1	FE	E	04-		0,70	-	-	-	DCPR8EIX	6546
650	1	FS	C / E	99-		0,70	DCPR8E	4339	-	DCPR8EIX	6546
650	1	FX	E	99-		0,70	DCPR8E	4339	-	DCPR8EIX	6546
650	1	SM		99-		0,70	DCPR8E	4339	-	DCPR8EIX	6546



HUSQVARNA

50	1		Husky Boy / Racing / J / S	98-		0,50	B7HS	5110	03	BR7HIX	7067
50	1		Husky Boy Junior	03-		0,60	B10EGV	5927	-	-	-
50	1	CR	Minimotard	10-		0,70	BR9ES	5722	02	BR9EIX	3981
50	1	SM	Minimotard	10-		0,70	BR9ES	5722	02	BR9EIX	3981
50	1	WRS		99-		0,50	B9ES	2611	02	BR9EIX	3981
50	1	WSM	Super Motard	02-		0,70	BR9ES	5722	02	BR9EIX	3981
50	1	WXE	Enduro	03-		0,70	BR9ES	5722	02	BR9EIX	3981
65	1	CR	Minicross, Minimotard	11-		0,60	BR8ECM	3035	-	BR8ECMIX	3520
125	1	CR		90-97		0,60	B10EGV	5927	-	-	-
125	1	CR		98-99		0,60	BR9EG	3230	-	-	-
125	1	CR		99-00		0,60	B10EGV	5927	-	-	-
125	1	CR		00-		0,50	BR9EG	3230	-	-	-
125	1	CR	2 Temps	92-05		0,50	BR9EG	3230	-	-	-
125	1	SM		98-		0,60	B9EG	3530	-	-	-
125	1	SMS		00-		0,50	BR9EG	3230	-	-	-
125	1	SMS		11-		0,60	CR8E	1275	04	CR8EIX	4218
125	1	TE	4 Temps	11-		0,70	CR8E	1275	04	CR8EIX	4218
125	1	WR		95-99		0,50	B95EGV	2145	-	-	-
125	1	WR		00-		0,50	BR9EG	3230	-	-	-
125	1	WR	2 Temps	05-		0,50	BR9EG	3230	-	-	-
125	1	WRE		98-		0,60	B9EG	3530	-	-	-
125	1	WRE	Compétition	98-		0,50	R7435-10	4897	-	-	-
125	1	WSM		04-		0,70	CR7HSA	4549	07	CR7HIX	7544
125	1	WXE		04-		0,70	CR7HSA	4549	07	CR7HIX	7544
240		WR		-		0,50	B8EG	3430	-	-	-
250	1	CR		95-99		0,50	B9EGV	5827	-	-	-
250	1	CR		00-		0,50	B8EG	3430	-	-	-
250	1	CR		01-		0,50	BR8EG	3130	-	-	-
250	1	TC	4 Temps	05-		0,70	CR8EB	7784	04	CR8EIX	4218
250	1	TC	MY 2010	09-		0,70	CR9EB	6955	06	CR9EIX	3521
250	1	TE	4 Temps	02-		0,70	CR8EB	7784	04	CR8EIX	4218
250	1	TE	Meo Replica	11-		0,70	CR9EB	6955	06	CR9EIX	3521
250	1	WR		92-95		0,50	B9EGV	5827	-	-	-
250	1	WR		96-97		0,60	B9EG	3530	-	-	-
250	1	WR		98-99		0,50	B9EGV	5827	-	-	-
250	1	WR		00-		0,50	B8EG	3430	-	-	-
250	1	WR	2 Temps	12-		0,60	BR8EG	3130	-	-	-
260	1	WR		90-		0,50	B9EGV	5827	-	-	-
300	1	WR		09-		0,60	BR8EG	3130	-	-	-
310	1	TE		09-10		0,70	CR8EB	7784	04	CR8EIX	4218
350	1	TE		90-		0,70	C7E	5096	12	CR7EIX	7385
360	1	CR		91-		0,50	B8EGV	5627	-	-	-
360	1	WR		01-		0,50	B8EG	3430	-	-	-
390	1	MX		-		0,50	B9ES	2611	02	BR9EIX	3981
400	1	MX		-		0,50	B9ES	2611	02	BR9EIX	3981
400	1	TE	4 Temps	01-		0,60	C7E	5096	12	CR7EIX	7385
400	1	TE	4 Temps	02-		0,70	CR8EB	7784	04	CR8EIX	4218
400	1	WR		-		0,50	B8EGV	5627	-	-	-
410	1	TE		95-00		0,60	C7E	5096	12	CR7EIX	7385
430	1	CR		-		0,50	B9ES	2611	02	BR9EIX	3981
450		TC		04-		0,70	CR8EB	7784	04	CR8EIX	4218
450	1	TC	449 4 Temps	11-		0,70	CR9EKB	2305	-	CR9EIX	3521
450		TE		03-		0,70	CR8EB	7784	04	CR8EIX	4218
450	1	TE	4 Temps	05-10		0,70	CR8EB	7784	04	CR8EIX	4218

HUSQVARNA

CYL.	Nb Cyl.	TYPE	MODÈLE		INFO			N° STOCK	N° BLISTER		N° STOCK IX
450	1	TE	449 4 Temps	11-		0,70	CR9EKB	2305	-	CR9EIX	3521
450	1	SMR		04-		0,80	CR8EB	7784	04	CR8EIX	4218
450	1	SMR	449	11-		0,80	CR9EKB	2305	-	CR9EIX	3521
480	1	SMR	511	11-		0,80	CR9EKB	2305	-	CR9EIX	3521
480	1	TE	511	11-		0,80	CR9EKB	2305	-	CR9EIX	3521
500		CR		-		0,50	B8EG	3430	-	-	-
500		WR		-		0,50	B8EG	3430	-	-	-
510	1	AC		-		0,90	DP8EA-9	5829	08	DPR8EIX-9	2202
510	1	TE		-		0,90	DP8EA-9	5829	08	DPR8EIX-9	2202
510	1	TE	4 Temps	05-		0,70	CR8EB	7784	04	CR8EIX	4218
510	1	SMR		10-		0,70	CR8EB	7784	04	CR8EIX	4218
570	1	NOX	Super Motard	01-		0,70	C7E	5096	12	CR7EIX	7385
570		SM		01-04		0,60	CR7EB	4663	12	CR7EIX	7385
570	1	SM	R	01-		0,70	C7E	5096	12	CR7EIX	7385
570	1	TC		01-		0,70	C7E	5096	12	CR7EIX	7385
570	1	TE		01-		0,70	C7E	5096	12	CR7EIX	7385
600		SMS	i.e	11-		0,70	CR8EB	7784	04	CR8EIX	4218
600	1	TE	630	10-		0,60	CR8EB	7784	04	CR8EIX	4218
600		TE	i.e	11-		0,70	CR8EB	7784	04	CR8EIX	4218
610	1	LT		00-		0,60	C7E	5096	12	CR7EIX	7385
610	1	SM		06-		0,60	CPR8E	7411	-	-	-
610	1	SM	S	98-		0,70	C7E	5096	12	CR7EIX	7385
610	1	SM	R	00-		0,70	C7E	5096	12	CR7EIX	7385
610	1	TC		91-00		0,70	C7E	5096	12	CR7EIX	7385
610	1	TC		06-		0,60	CPR8E	7411	-	-	-
610	1	TE		91-00		0,70	C7E	5096	12	CR7EIX	7385
610	1	TE	E	98-05		0,60	CR7E	4578	12	CR7EIX	7385
630	1	SM	R	-		1,10	R0045J-10	7400	-	-	-
630	1	SMR		09-		0,60	CR8EB	7784	04	CR8EIX	4218
900	2		Nude, Nude R	12-		0,90	LMAR8C-9	93833	-	-	-







HUSQVARNA - Quad

450		QM		05-		0,70	CR8EB	7784	04	CR8EIX	4218
-----	--	----	--	-----	--	------	-------	------	----	--------	------



HYOSUNG

50	1	SB	G Cab	95-		0,60	BP6HS	4511	-	BPR6HIX	4085
50	1	SB	G Gamma	97-		0,60	BP6HS	4511	-	BPR6HIX	4085
50	1	SB	Plus & M	-		0,60	BP6HS	4511	-	BPR6HIX	4085
50	1	SD	Avanti	99-		0,60	BP6HS	4511	-	BPR6HIX	4085
50	1	SD	Sense	99-05		0,60	BP6HS	4511	-	BPR6HIX	4085
50	1	SF		99-		0,60	BR8HSA	5539	-	BR8HIX	7001
50	1	SF	B Prima, Racing	-		0,60	BR8HSA	5539	-	BR8HIX	7001
50	1	SF	Rally	04-		0,60	BR8HSA	5539	-	BR8HIX	7001
100	1	EZ	M	-		0,60	BP7HS	5111	14	BPR7HIX	5944
100	1	EZ	Supercab	97-		0,60	BP7HS	5111	14	BPR7HIX	5944
110		FX		-		0,70	C6HSA	3228	-	CR6HIX	7274
110			Midas DLX	99-		0,70	C6HSA	3228	-	CR6HIX	7274
125	1		Boomer	02-		0,60	DR8EA	7162	11	DR8EIX	6681
125	2		Comet	01-		0,70	CR8E	1275	04	CR8EIX	4218
125			Cruise 1	96-		0,70	D8EA	2120	11	DR8EIX	6681
125			Cruise 2	99-		0,90	CR8EH-9	5666	10	CR8EHIX-9	3797
125	1		Exceed	02-		0,70	DR8EA	7162	11	DR8EIX	6681
125	1		Karion	02-09		0,90	CR8EH-9	5666	10	CR8EHIX-9	3797
125	1		Karion	10-		0,90	C8EH-9	7473	10	CR8EHIX-9	3797
125	1	GA	Cruise I / FII / Classic	-		0,90	DP8EA-9	5829	08	DPR8EIX-9	2202
125		GA	Cruise III	00-		0,90	CR8EH-9	5666	10	CR8EHIX-9	3797
125	1	GF	I & II	99-		0,90	CR8EH-9	5666	10	CR8EHIX-9	3797
125	1	GPS	Grand Prix	-		0,60	DR8EA	7162	11	DR8EIX	6681
125	1	GPS	DLX Grand Prix Plus	99-		0,60	DR8EA	7162	11	DR8EIX	6681
125	1	GPS	Grand Prix 2 Plus	01-		0,60	DR8EA	7162	11	DR8EIX	6681
125		GT		03-		0,60	CR8E	1275	04	CR8EIX	4218
125	2	GT	R	05-		0,90	CR8EH-9	5666	10	CR8EHIX-9	3797
125	1	GS		97-		0,60	DR8EA	7162	11	DR8EIX	6681
125	2	GV	Aquila (V2 Custom)	00-		0,70	CR8E	1275	04	CR8EIX	4218
125		GV	C	08-		0,80	CR8E	1275	04	CR8EIX	4218
125		HD	Hyper	04-06		0,80	DR8EA	7162	11	DR8EIX	6681
125		MS3		07-		0,80	CR8E	1275	04	CR8EIX	4218
125	1	RT	D Karion	07-		0,90	CR8EH-9	5666	10	CR8EHIX-9	3797
125	1	RX	D, SM	07-		0,90	CR8EH-9	5666	10	CR8EHIX-9	3797
125	1	XRX	Trail	99-		0,90	CR8EH-9	5666	10	CR8EHIX-9	3797
250	2	GT		05-		0,70	CR8E	1275	04	CR8EIX	4218
250	2	GV	Aquila (V2 Custom)	00-		0,70	CR8E	1275	04	CR8EIX	4218

CYL.	Nb Cyl.	TYPE	MODÈLE		INFO			N° STOCK	N° BLISTER		N° STOCK IX
250		MS3		07-		0,80	CR8E	1275	04	CR8EIX	4218
650	2		Aquila	06-		0,70	CR8E	1275	04	CR8EIX	4218
650	2		Comet	07-		0,80	CR8E	1275	04	CR8EIX	4218
650		GT	GT650, Comet	03-		0,80	CR8E	1275	04	CR8EIX	4218
650		GT	GT650 EFI, Comet	08-		0,80	CR8E	1275	04	CR8EIX	4218
650	2	GT	R,S	05-		0,70	CR8E	1275	04	CR8EIX	4218
650		GT	R EFI	08-		0,80	CR8E	1275	04	CR8EIX	4218
650		GT	X	08-		0,70	CR8E	1275	04	CR8EIX	4218
650			GV650, Aquila	06-08		0,80	CR8E	1275	04	CR8EIX	4218
650			GV650 EFI, Aquila	08-		0,80	CR8E	1275	04	CR8EIX	4218
680			GV700C EFI	10-		0,80	CR8E	1275	04	CR8EIX	4218
700	2		ST 700i	10-		0,70	CR8E	1275	04	CR8EIX	4218



HYOSUNG - Quad

50	1		4x2	03-		0,80	BP6HS	4511	-	BPR6HIX	4085
50	1		Wow 50	04-		0,70	BP7HS	5111	14	BPR7HIX	5944
50	1	HY		05-		0,70	CR7HSA	4549	07	CR7HIX	7544
90	1		4x2	03-		0,80	BPR7HS	6422	14	BPR7HIX	5944
90	1		Wow 90	04-		0,70	BP7HS	5111	14	BPR7HIX	5944
450		TE		07-		0,60	CR8E	1275	04	CR8EIX	4218
450	1		R	07-		0,60	CR8E	1275	04	CR8EIX	4218
450			Rapier	10-		0,60	CR8E	1275	04	CR8EIX	4218



HYTRACK - Voir aussi LINHAI

420	1	HY	4x4	-		0,60	DR8EA	7162	11	DR8EIX	6681
550		HY	Moteur LINHAI	08-		0,60	DR8EA	7162	11	DR8EIX	6681



HYTRACK - Voir aussi LINHAI



ITALJET

50	1		Ascot 50, Bazooka, Bazooka II	-		0,60	BP7HS	5111	14	BPR7HIX	5944
50	1		Cruise	95-		0,60	BP6HS	4511	-	BPR6HIX	4085
50	1		Dragster	96-98		0,60	BPR8HS	3725	-	BPR8HIX	6742
50	1		Dragster, Dragster Café racer	98-		0,60	BR8HS	4322	01	BR8HIX	7001
50	1		Fastboy	98-		0,60	BR7HS	4122	03	BR7HIX	7067
50	1		Formula 50	95-		0,60	BPR6HS	7022	-	BPR6HIX	4085
50	1		Formula 50 AC	98		0,60	BR7HS	4122	03	BR7HIX	7067
50	1		Formula 50 AC	99-		0,60	BR8HS	4322	01	BR8HIX	7001
50	1		Formula, Race, Sport, Williams	96-		0,60	BPR6HS	7022	-	BPR6HIX	4085
50	1		Formula L.C.	-		0,60	BPR7HS	6422	14	BPR7HIX	5944
50			Jetset 50 2T	01-04		0,70	BR9ES	5722	02	BR9EIX	3981
50	1		Pack III	91-		0,50	B6HS	4510	09	BR6HIX	3419
50	1		Pirana	-		0,50	B6HS	4510	09	BR6HIX	3419
50	1		Pista 50	95-		0,60	BP7HS	5111	14	BPR7HIX	5944
50	1		Pista II	-		0,60	BP7HS	5111	14	BPR7HIX	5944
50	1		Pulse	-		0,50	B6HS	4510	09	BR6HIX	3419
50	1		Reporter	-		0,60	BP7HS	5111	14	BPR7HIX	5944
50	1		Scoop 50	95-		0,60	BP7HS	5111	14	BPR7HIX	5944
50	1		Sunny 50	-		0,60	BP6HS	4511	-	BPR6HIX	4085
50	1		Tiffany	95-		0,50	B6HS	4510	09	BR6HIX	3419
50	1		Torpedo 2 Temps	-		0,60	B7HS	5110	03	BR7HIX	7067
50	1		Torpedo 4 Temps	-		0,60	CR7E	4578	12	CR7EIX	7385
50	1		Torpedo 25	97-		0,60	BPR8HS	3725	-	BPR8HIX	6742
50	1		Velocifero	96-00		0,70	BPR6HS	7022	-	BPR6HIX	4085
50	1		Velocifero "8", "10"	98-		0,60	BR8HS	4322	01	BR8HIX	7001
50	1		Winner	-		0,50	B5HS	4210	-	-	-
50	1		Yankee	95-		0,60	BP7HS	5111	14	BPR7HIX	5944
100			Millennium 100	00-04		0,60	BR7HS	4122	03	BR7HIX	7067
125			Jetset 125 4T	01-04		0,60	CR7E	4578	12	CR7EIX	7385
125	1		Jupiter	-		0,70	CR8E	1275	04	CR8EIX	4218
125	1		Millenium - 4 Temps	99-04		0,70	CR8E	1275	04	CR8EIX	4218
125	1		Super Range	-		0,50	B7HS	5110	03	BR7HIX	7067
125	1		Torpedo - 4 Temps	98-		0,60	CR7E	4578	12	CR7EIX	7385
125	1		Union	98-		0,50	BP7HS	5111	14	BPR7HIX	5944
150			Jetset 150 4T	01-04		0,60	CR7E	4578	12	CR7EIX	7385
150	1		Jupiter	-		0,70	CR8E	1275	04	CR8EIX	4218
150	1		Millenium - 4 Temps	99-		0,70	CR8E	1275	04	CR8EIX	4218
150	1		Torpedo - 4 Temps	99-		0,70	CR8EB	7784	04	CR8EIX	4218
180	1		Dragster	98-		0,60	BR9ES	5722	02	BR9EIX	3981
250	1		Millenium	99-		0,70	DR8EA	7162	11	DR8EIX	6681
250			Jupiter	01-04		0,70	DR8EA	7162	11	DR8EIX	6681

JAWA

CYL. Nb Cyl. TYPE MODÈLE



INFO



N° STOCK

N° BLISTER



N° STOCK IX



JAWA

50		Jawa Economy, Jive, Jazz	-	0,50	B6HS	4510	09	BR6HIX	3419
50		MJ50, Korado Basic/K'start, Lux	-	0,50	B6HS	4510	09	BR6HIX	3419
125	1	Betka	06-	0,60	C7HSA	4629	07	CR7HIX	7544
125	1	Dandy	00-	0,70	DR8ES	5423	11	DR8EIX	6681
350	2	Chopper	-	0,50	B8HS	5510	01	BR8HIX	7001
350	2	Scot Sabater	00-	0,50	B8HS	5510	01	BR8HIX	7001
350	2	Style	-	0,50	B8HS	5510	01	BR8HIX	7001
500	1	R	-	0,50	D8EA	2120	11	DR8EIX	6681
650	1	Classic, Dakar, Style	06-	0,70	DR8EA	7162	11	DR8EIX	6681



JCM

125	1	Trial	-	0,60	BP6ES	7811	-	BPR6EIX	6637
240	1	Trial	-	0,60	BP7ES	2412	-	BPR7EIX	4055
333	1	Trial	-	0,60	BP7ES	2412	-	BPR7EIX	4055



JIALING

50	1	CJ F/K	-	0,70	BPR6HS	7022	-	BPR6HIX	4085
50	1	JD	97-	0,60	BPR6HSA	4632	-	BPR6HIX	4085
50	1	JH	95-	0,70	C7HSA	4629	07	CR7HIX	7544
50	1	JL	97-	0,60	BPR6HSA	4632	-	BPR6HIX	4085
50	1	LX	-	0,70	BPR6HSA	4632	-	BPR6HIX	4085
50	1	QM	-	0,70	BPR4HS	7823	-	-	-
50	1	TA 55	-	0,70	BPR6HSA	4632	-	BPR6HIX	4085
70	1	CJ	-	0,70	CR7HSA	4549	07	CR7HIX	7544
70	1	JD, JH	94-	0,70	C7HSA	4629	07	CR7HIX	7544
90	1	JH	94-	0,70	C6HSA	3228	-	CR6HIX	7274
90	1	K	-	0,70	BP7HS	5111	14	BPR7HIX	5944
100	1	K, QM	-	0,70	BP7HS	5111	14	BPR7HIX	5944
125	1	JH	94-	0,70	DR8ES-L	2923	-	DR8EIX	6681
125	1	Sanyang Duke	-	0,90	DPR7EA-9	5129	13	DPR7EIX-9	7803
125	1	Sanyang Wolf	-	0,70	DR8ES-L	2923	-	DR8EIX	6681



JIANSHE

125	1	JS125Y Tiger	03-	0,70	DR8ES	5423	11	DR8EIX	6681
-----	---	--------------	-----	------	-------	------	----	--------	------



JINCHENG

50	1	JC 50 Q, JC 50 Q-7, TR 36 L	-	0,60	C7HSA	4629	07	CR7HIX	7544
70	1	CJ 70 A	-	0,70	CR6HSA	2983	-	CR6HIX	7274
90	1	JC 90, JC 90-2B	-	0,70	CR6HSA	2983	-	CR6HIX	7274
100	1	JC 100-7 Cruiser	-	0,60	C7HSA	4629	07	CR7HIX	7544
125	1	JC 125 A, JC 125 7B	-	0,70	DR8EA	7162	11	DR8EIX	6681



JMSTAR

125	1	CJ12M	-	0,70	C7HSA	4629	07	CR7HIX	7544
-----	---	-------	---	------	-------	------	----	--------	------



JOHN DEERE - Quad

500		Buck	-	0,60	DR8EA	7162	11	DR8EIX	6681
500		Trail Buck	-	0,80	DCPR8E	4339	-	DCPR8EIX	6546
650		Trail Buck	-	0,80	DCPR8E	4339	-	DCPR8EIX	6546



JOHN DEERE - SSV

-		Gator 4x2	-	0,80	BPR6ES	7822	-	BPR6EIX	6637
-		Gator Kawasaki 10 hp	-	0,60	B5HS	4210	-	-	-
-		Gator Kawasaki OHV 18hp	-	0,60	BMR6A	7421	-	-	-
-	2	Gator Kawasaki FD620D 20hp	-	0,90	BMR2A-10	4452	-	-	-
250	1	Gator Kawasaki FE250D 8hp	-	0,70	BPR5ES	7422	-	BPR5EIX	6597
290	1	Gator Kawasaki FE290D 9.5hp	-	0,70	BPR5ES	7422	-	BPR5EIX	6597
854	3	Gator 6x4	-	0,90	BMR2A-10	4452	-	-	-



JONWAY

125				09-	0,80	CR7HSA	4549	07	CR7HIX	7544
-----	--	--	--	-----	------	--------	------	----	--------	------



KAWASAKI





50			AE50 A1/A2, AR50 A1/C1-C10	81-97	0,70	B6ES	7310	-	-	-
50	1	KDX	KDX50	03-06	0,70	BPR4HS	7823	-	-	-
60	1	KX	KX60	95-02	0,70	BR9EG	3230	-	-	-
65	1	KX	KX65	00-15	0,70	BR10EG	3830	-	-	-
80	1	KX	KX80	92-00	0,80	R6252K-105	2741	-	-	-
85	1	KX	KX85	01-15	0,80	R6252K-105	2741	-	-	-
100	1	KE	KE100	87-95	0,70	B8ES	2411	05	BR8EIX	5044
100	1	KE	KE100	96-01	0,70	BR8ES	5422	05	BR8EIX	5044
100	1	KX	KX100	92-97	0,70	R6254K-105	4076	-	-	-
100	1	KX	KX100	98-15	0,70	R6252K-105	2741	-	-	-
110	1	AN	AN112	08-11	0,70	C6HSA	3228	-	CR6HIX	7274
110	1	AN	AN112 (Edge R & VR) RCF-SCF	12	0,70	C6HSA	3228	-	CR6HIX	7274
110	1	AN	AN112-SDF	13	0,70	C6HSA	3228	-	CR6HIX	7274
110	1	KLT		86-	0,70	C6HSA	3228	-	CR6HIX	7274
110	1	KLX	KLX110	02-14	0,70	CR6HSA	2983	-	CR6HIX	7274
110	1	KLX	KLX110L	10-14	0,70	CR6HSA	2983	-	CR6HIX	7274
110	1	KLX	KLX110 & KLX111 Monster Energy	09	0,70	CR6HSA	2983	-	CR6HIX	7274
110	1	KLX	KLX140 & KLX140L Monster Energy	09	0,70	CR6HSA	2983	-	CR6HIX	7274
110		KSR		03-	0,60	CR6HSA	2983	-	CR6HIX	7274
125	1	D	D-Tracker	09-	0,80	CR7HSA	4549	07	CR7HIX	7544
125	1	EL	BN125	98-	0,80	CR7E	4578	12	CR7EIX	7385
125	1	BN	Eliminator	01-07	0,80	CR7E	4578	12	CR7EIX	7385
125	1	KLX	KLX125, KLX125L	03-06	0,60	DR8EA	7162	11	DR8EIX	6681
125	1	KLX		09-	0,80	CR7HSA	4549	07	CR7HIX	7544
125	1	KMX	KMX125	86-01	0,80	BR8ES	5422	05	BR8EIX	5044
125	1	KX	KX125	94-96	0,60	-	-	-	BR9EIX	3981
125	1	KX	KX125	97	0,80	R6252K-105	2741	-	-	-
125	1	KX	KX125	98-03	0,60	-	-	-	BR9EIX	3981
125	1	KX	KX125	04-05	0,60	R6918B-9	2954	-	-	-
140	1	KLX	KLX140, KLX140L	08-15	0,80	CR7HSA	4549	07	CR7HIX	7544
160	1	KLT		85-	0,70	D8EA	2120	11	DR8EIX	6681
200	1	KDX	KDX200	95-06	0,80	BR8ES	5422	05	BR8EIX	5044
220	1	KDX	KDX220R	97-05	0,80	BR8ES	5422	05	BR8EIX	5044
250			Ninja R	08-	0,70	CR8E	1275	04	CR8EIX	4218
250	1	BJ	A Estrella	93-96	0,70	DR8ES	5423	11	DR8EIX	6681
250	1	BJ	C Estrella	97-	0,70	DR9EA	3437	-	DR9EIX	4772
250	1	EL	Eliminator	96-99	0,70	CR8HSA	2086	-	CR8HIX	7669
250	2	EX	K8F Ninja R	08-	0,80	CR8E	1275	04	CR8EIX	4218
250	1	KL	KLR250	84-05	0,90	DPR9EA-9	5329	-	DPR9EIX-9	5545
250	1	KL	KL250GAF	10	0,80	CR8E	1275	04	CR8EIX	4218
250	1	KLX	KLX250R	93-96	0,80	CR8E	1275	04	CR8EIX	4218
250	1	KLX	KLX250S	06-07	0,80	CR8E	1275	04	CR8EIX	4218
250	1	KR		-	0,80	B9ES	2611	02	BR9EIX	3981
250	1	KX	KX250	92-94	0,60	R7376-9	7763	-	-	-
250	1	KX	KX250	95-04	0,80	-	-	-	BR8EIX	5044
250	1	KX	KX250	05-07	0,60	-	-	-	BR8ECMIX	3520
250	1	KX	KX250F	04-05	0,70	CR8EB	7784	04	CR8EIX	4218
250	1	KX	KX250F	06-10	0,70	CR8E	1275	04	CR8EIX	4218
250	1	KX	KX250F	11-15	0,90	CPR8EB-9	6607	-	-	-
300	1	KLX	KLX300R	96-07	0,80	CR8E	1275	04	CR8EIX	4218
305			EX305 B2-B10 (GPz305)	84-96	0,90	DPR9EA-9	5329	-	DPR9EIX-9	5545
400	4	GPZ		-	0,90	DPR9EA-9	5329	-	DPR9EIX-9	5545
400	1	KLX	KLX400SR	03	0,80	CR8E	1275	04	CR8EIX	4218
400	1	KLX	KLX400R	03-04	0,80	CR8E	1275	04	CR8EIX	4218
400		ZL	Eliminator	93-	0,70	DR8ES	5423	11	DR8EIX	6681
400		ZXR	R	-	0,80	CR9EK	4548	-	CR9EIX	3521
450		KLX	/R	08-	0,90	CPR8EB-9	6607	-	-	-
450	1	KLX	KLX450R	12-14	0,90	CPR8EB-9	6607	-	-	-
450	1	KX	KX450F	06-15	0,90	CPR8EB-9	6607	-	-	-
500		EN		94-99	0,70	DR9EA	3437	-	DR9EIX	4772
500		ER5	ER500-A1~4, C1~2	97-02	0,70	DR9EA	3437	-	DR9EIX	4772
500		GPZ	R, S	-	0,70	DR8ES	5423	11	DR8EIX	6681
500		GPZ	S (EX500D)	94-96	0,70	DR9EA	3437	-	DR9EIX	4772
500		GPZ	S (EX500E4)	97-	0,70	DR9EA	3437	-	DR9EIX	4772
500	2	KLE		90-	0,70	DR9EA	3437	-	DR9EIX	4772
500	1	KX	KX500	88-04	0,60	BR8EG	3130	-	-	-
550		ZR	B Zephyr	91-	0,70	DR9EA	3437	-	DR9EIX	4772
600	4		Eliminator ZL600-B1~3	95-97	0,70	D9EA	2420	-	DR9EIX	4772

CYL.	Nb Cyl.	TYPE	MODÈLE		INFO			N° STOCK	N° BLISTER		N° STOCK IX
600	1	KLR		85-		0,90	DPR8EA-9	4929	08	DPR8EIX-9	2202
600	4	GPZ	R	-		0,70	DR8ES	5423	11	DR8EIX	6681
600	4	ZX-6	R Ninja / RR Ninja (K1)	95-03		0,80	CR9E	6263	06	CR9EIX	3521
600	4	ZX-6	RR Ninja	04-		0,80	CR9E	6263	06	CR9EIX	3521
600	4	ZX-6R	Ninja	08-		0,70	CR9E	6263	06	CR9EIX	3521
600	4	ZZR		90-04		0,80	CR9E	6263	06	CR9EIX	3521
636	4	ZX-6	R Ninja / R Ninja (B1)	02-		0,80	CR9E	6263	06	CR9EIX	3521
636	4	ZX-6	R, RR	04-		0,70	CR9E	6263	06	CR9EIX	3521
650	2		Versys	10-		0,90	CR9EIA-9	6289	-	-	-
650	2	ER-6N	ER650	06-14		0,90	CR9EIA-9	6289	-	-	-
650	2	EX	Ninja (EX650JHF)	17-		0,90	CR9EIA-9	6289	-	-	-
650	1	KL	KLR650	87-07		0,90	DPR8EA-9	4929	08	DPR8EIX-9	2202
650	1	KL	KLR650 New Edition	14		0,90	DPR8EA-9	4929	08	DPR8EIX-9	2202
650	2	KLE	Versys	07-09		0,90	CR9EIA-9	6289	-	-	-
650	2	KLE	Versys ABS	14		0,90	CR9EIA-9	6289	-	-	-
650	1	KLX	KLX650, KLX650R	93-96		0,90	DPR8EA-9	4929	08	DPR8EIX-9	2202
650	2	W		99-05		0,80	CR8E	1275	04	CR8EIX	4218
650		Z		-		0,80	BR7ES	5122	-	BR7EIX	6664
750	4	GPX	R	85-		0,70	DR8ES	5423	11	DR8EIX	6681
750	4	GPZ	R	85-		0,70	DR8ES	5423	11	DR8EIX	6681
750	2	VN		-		0,90	DPR8EA-9	4929	08	DPR8EIX-9	2202
750	4	Z	S	04-06		0,80	CR9EK	4548	-	CR9EIX	3521
750	4	Z	R	11-		0,70	CR9EK	4548	-	CR9EIX	3521
750	4	ZR	S	05-		0,80	CR9EK	4548	-	CR9EIX	3521
750	4	ZR	Zephyr	91-95		0,70	DR8ES	5423	11	DR8EIX	6681
750	4	ZR	Zephyr	96-99		0,70	DR9EA	3437	-	DR9EIX	4772
750	4	ZR-7		99-		0,70	DR9EA	3437	-	DR9EIX	4772
750	4	ZR-7	S	01-		0,70	DR9EA	3437	-	DR9EIX	4772
750	4	ZX-7	R, RR Ninja	93-		0,80	CR9E	6263	06	CR9EIX	3521
750	4	ZX		04-		0,70	DR9EA	3437	-	DR9EIX	4772
750	4	ZXR	R / L / M	88-		0,80	CR9E	6263	06	CR9EIX	3521
800	2	VN	A	95-98		0,80	CR7E	4578	12	CR7EIX	7385
800	2	VN	B Classic, C Drifter	96-		0,80	CR7E	4578	12	CR7EIX	7385
800	2	VN	Vulcan	06-		0,90	CPR7EA-9	3901	-	CPR7EAIX-9	9198
800	2	W	SE	11-		0,70	CR8E	1275	04	CR8EIX	4218
900	2	VN	A6F, B7F (Classic)	06-		0,90	CPR7EA-9	3901	-	CPR7EAIX-9	9198
900	2	VN	Custom, Classic, Light Tourer, Classic Special	-		0,90	CPR7EA-9	3901	-	CPR7EAIX-9	9198
900	4	ZX-9	R Ninja	94-04		0,80	CR9EK	4548	-	CR9EIX	3521
1000	4	GTR		94-99		0,70	DR9EA	3437	-	DR9EIX	4772
1000	2	KLX		04-		0,70	CR8EK	3478	-	CR8EIX	4218
1000	4	KLZ	Versys 1000 (KLZ1000ACF)	12		0,90	CR9EIA-9	6289	-	-	-
1000	4	KZ	Police 1000 (KZ1000-P10~24)	91-05		0,80	BR8ES	5422	05	BR8EIX	5044
1000	4	Z		03-06		0,80	CR9EK	4548	-	CR9EIX	3521
1000	4	Z		07-		0,90	CR9EIA-9	6289	-	-	-
1000	4	Z	SX	10-		0,90	CR9EIA-9	6289	-	-	-
1000	4	ZR		07-		0,90	CR9EIA-9	6289	-	-	-
1000	4	ZX 10	Tomcat	-		0,80	CR9E	6263	06	CR9EIX	3521
1000	4	ZX-10R	Ninja (ZX100D6F)	04-		0,90	CR9EIA-9	6289	-	-	-
1100	4	GPZ		95-99		0,80	CR9EK	4548	-	CR9EIX	3521
1100	4	ZR	Zephyr	92-97		0,80	CR9E	6263	06	CR9EIX	3521
1100	4	ZRX	R	97-01		0,80	CR9EK	4548	-	CR9EIX	3521
1100	4	ZX-11	Ninja	93-		0,80	CR9E	6263	06	CR9EIX	3521
1100	4	ZZR		90-01		0,80	CR9E	6263	06	CR9EIX	3521
1200	4	ZRX	R, S	01-		0,80	CR9EK	4548	-	CR9EIX	3521
1200	4	ZX-12	R Ninja	00-07		0,80	CR9EKPA	7785	-	-	-
1200	4	ZZR		02-04		0,80	CR9E	6263	06	CR9EIX	3521
1400	4	GTR		07-		0,90	CR9EIA-9	6289	-	-	-
1400	4	ZZR		06-		0,90	CR9EIA-9	6289	-	-	-
1500	2	VN	Classic D	-95		0,90	DPR7EA-9	5129	13	DPR7EIX-9	7803
1500	2	VN	Classic, Classic Tourer E	96-		0,90	DPR5EA-9	2887	-	-	-
1500	4	Vulcan	Vulcan Drifter VN1500-J1~2, R1~2	99-02		0,90	DPR6EA-9	5531	-	-	-
1500	2	VN	Mean Streak	02-		0,90	DPR6EA-9	5531	-	-	-
1600	2	VN	Classic, Classic Tour	03-		0,90	DPR6EA-9	5531	-	-	-
1600	2	VN	Classic Tourer	04-		0,90	DPR6EA-9	5531	-	-	-
1600	2	VN	Meanstreak	03-		0,90	DPR6EA-9	5531	-	-	-
1600	2	VN	Tourer	05-		0,90	DPR6EA-9	5531	-	-	-
1700	2	VN	Voyager / Voyager Custom	10-		1,10	ILZKAR7B11	6283	-	-	-
2000	2	VN		04-		1,10	IZFR6F11	4095	-	-	-



KAWASAKI - Quad

50	1	KSF	KFX50	03-06		0,70	BPR4HS	7823	-	-	-
50	1	KSF	KFX50	07-09		0,80	CR7HSA	4549	07	CR7HIX	7544
50	1	KSF	KFX50	13-15		0,80	CR7HSA	4549	07	CR7HIX	7544
80	1	KSF	KFX80	03-06		0,60	BPR7HS	6422	14	BPR7HIX	5944

CYL.	Nb Cyl.	TYPE	MODÈLE		INFO			N° STOCK	N° BLISTER		N° STOCK IX
90	1	KSF	KFX90	07-15		0,80	CR7HSA	4549	07	CR7HIX	7544
220	1	KLF	Bayou 220	88-02		0,70	DR8ES	5423	11	DR8EIX	6681
250	1	KLF	Bayou 250	03-11		0,70	DR8ES	5423	11	DR8EIX	6681
250	1	KSF	KFX250 Mojave	87-99		0,90	DP8EA-9	5829	08	DPR8EIX-9	2202
250	1	KSF	KFX250 Mojave	00-03		0,90	DPR8EA-9	4929	08	DPR8EIX-9	2202
300	1	KEF	Lakota	95-99		0,70	D8EA	2120	11	DR8EIX	6681
300	1	KEF	Lakota	00		0,70	DR7EA	7839	-	DR7EIX	5686
300	1	KEF	Lakota Sport	01-03		0,60	DR8EA	7162	11	DR8EIX	6681
300	1	KFX		95-		0,60	DR7EA	7839	-	DR7EIX	5686
300	1	KLF	Bayou 300 / 300 4x4	89-99		0,70	D8EA	2120	11	DR8EIX	6681
300	1	KLF	Bayou 300 / 300 4x4	00-04		0,60	DR8EA	7162	11	DR8EIX	6681
300	1	KVF	Brute Force 300	12-15		0,90	DPR7EA-9	5129	13	DPR7EIX-9	7803
300	1	KVF	Prairie	99-02		0,60	DR8EA	7162	11	DR8EIX	6681
360	1	KVF	Prairie 360 4x2	03-09		0,90	DPR8EA-9	4929	08	DPR8EIX-9	2202
360	1	KVF	Prairie 360 4x4	03-13		0,90	DPR8EA-9	4929	08	DPR8EIX-9	2202
400	1	KSF	KFX400	03-06		0,70	CR7E	4578	12	CR7EIX	7385
400	1	KLF	Bayou 400 4x4	93-99		0,90	DPR8EA-9	4929	08	DPR8EIX-9	2202
400	1	KVF	Prairie 400	97-02		0,90	DPR8EA-9	4929	08	DPR8EIX-9	2202
450	1	KFX	KFX450R	08-14		0,90	CPR8EB-9	6607	-	-	-
650	2	KVF	Prairie 650 4x4	02-03		0,70	CR7E	4578	12	CR7EIX	7385
650	2	KVF	Brute Force 650 4x4	05-13		0,80	CR7E	4578	12	CR7EIX	7385
700	2	KSV	KFX700 V Force	04-09		0,80	CR7E	4578	12	CR7EIX	7385
700	2	KVF	Prairie 700 4x4	04-06		0,70	CR7E	4578	12	CR7EIX	7385
750	2	KVF	Brute Force 750 4x4i	05-14		0,80	CR7E	4578	12	CR7EIX	7385
750	2	KVF	Brute Force 750 4x4i EPS	12-14		0,80	CR7E	4578	12	CR7EIX	7385
750	2	KVF	Brute Force 750 4x4i EPS / EPS CAMO	15		0,90	CPR7EA-9	3901	-	CPR7EIX-9	9198
750	2	KVF	Brute Force 750 4x4i Hardwoods Green HD	08-09		0,80	CR7E	4578	12	CR7EIX	7385
750	2	KVF	Brute Force 750 4x4i NRA Outdoors	08-09		0,80	CR7E	4578	12	CR7EIX	7385
750	2	KVF	Brute Force 750 4x4i Realtree APG HD	10		0,80	CR7E	4578	12	CR7EIX	7385

Bougies d'allumage



KAWASAKI - SSV

300		KAF	4x2	91-99		0,70	BPR5ES	7422	-	BPR5EIX	6597
300		KAF	D Mule 520	00-		0,70	BPR5ES	7422	-	BPR5EIX	6597
300	1	KAF	Mule 500	95-04		0,70	BPR5ES	7422	-	BPR5EIX	6597
400			Mule 610	07-		0,70	BPR5ES	7422	-	BPR5EIX	6597
401	1		Mule 4x2, 4x4	-		0,80	BPR2ES	2264	-	-	-
401	1		Mule 600 / Mule 610 4x4	10-		0,60	BPR5ES	7422	-	BPR5EIX	6597
450			Mule 1000 / KAF 450B (UV)	90-		0,70	D6EA	7512	-	-	-
450		KAF		91-		0,70	D7EA	7912	-	DR7EIX	5686
450		KAF	Liq. Cool.	92-96		0,70	D6EA	7512	-	-	-
550		KAF		94-		0,70	BPR5ES	7422	-	BPR5EIX	6597
620		KAF	B Mule 2520 / C Mule 2500	93-		0,70	BMR2A	7677	-	-	-
620	2	KAF	Mule 2500, Mule 2510 4x4	95-00		0,60	BMR2A	7677	-	-	-
620	2	KAF	Mule 3000, Mule 3010 4x4	01-04		0,60	BPR2ES	2264	-	-	-
950	3	KAF	Mule 2510 Diesel	00-02		11V	Y-706R	3041	-	-	-
950		KAF	Mule 3010 4x4 Diesel	03-04		11V	Y-706R	3041	-	-	-
950		KAF	Mule 3010 Trans Diesel	07-		11V	Y-706R	3041	-	-	-
953	3	KAF	Mule 4010 Diesel 4x4	10-		11V	Y-706R	3041	-	-	-



KEEWAY

50	1		Easy 25 V2, Easy 45 V2	-		0,80	BR7ES	5122	-	BR7EIX	6664
50	1		F-act	-		0,60	BR6HSA	4296	-	BR6HIX	3419
50	1		Flash	06-		0,60	BR6HSA	4296	-	BR6HIX	3419
50	1		Flash 25V1 / 45V1, Foc. 25V2 / 45V1 / 45V2	-		0,80	BR7ES	5122	-	BR7EIX	6664
50	1		Hurricane 25V2 / 45V1 / 45V2	-		0,80	BR7ES	5122	-	BR7EIX	6664
50	1		Hurricane (2-temps) Bougie Ø14mm	08-		0,60	BPR7HS	6422	14	BPR7HIX	5944
50	1		Hurricane (4-temps) Bougie Ø10mm	08-		0,70	C7HSA	4629	07	CR7HIX	7544
50	1		K1	07-		0,60	BR6HSA	4296	-	BR6HIX	3419
50	1		Matrix 25V2 / 45V1 / 45V2	-		0,80	BR7ES	5122	-	BR7EIX	6664
50	1		Pixel 50	07-		0,60	BR6HSA	4296	-	BR6HIX	3419
50	1		RY8 25 / 45 / 45SP	-		0,80	BR7ES	5122	-	BR7EIX	6664
50	1		X-Ray 50 Enduro V1/SM V1	-		0,80	BR8ES	5422	05	BR8EIX	5044
125	1		ARN, Foc., Matrix V1	-		0,70	CR6HSA	2983	-	CR6HIX	7274
125	1		F-act, Matrix V2	-		0,60	CR7HSA	4549	07	CR7HIX	7544
125	1		Outlook	06-		0,60	D7EA	7912	-	DR7EIX	5686
125	1		Silver Blade	07-		0,60	D7EA	7912	-	DR7EIX	5686
125	1		Speed, Superlight V1 / V2	-		0,60	DR7ES	3123	-	DR7EIX	5686
150	1		Speed	06-		0,60	D7EA	7912	-	DR7EIX	5686
150	1		Superbike	-		0,60	D7EA	7912	-	DR7EIX	5686
150	1		Superlight	06-		0,60	D7EA	7912	-	DR7EIX	5686

KEEWAY-Quad

CYL. Nb Cyl. TYPE MODÈLE



INFO



N° STOCK

N° BLISTER



N° STOCK IX

KEEWAY-Quad

250	1	Dragon 250	-	0,80	DR7ES	3123	-	DR7EIX	5686
-----	---	------------	---	------	-------	------	---	--------	------

KREIDLER

50	1	Florett 25 / 50	96-	0,60	BPR7HS	6422	14	BPR7HIX	5944
50	1	Florett RMC 25 / 50	05-	0,60	BPR7HS	6422	14	BPR7HIX	5944
50	1	Florett XL 25 / 50	-	0,60	BPR7HS	6422	14	BPR7HIX	5944
50	1	Florett (RM, RMS, RMC), GS50	-	0,50	B7HS	5110	03	BR7HIX	7067
50	1	Flory 4 temps	05-	0,60	C7HSA	4629	07	CR7HIX	7544
50	1	Flory 25 / 50	96-	0,60	BPR7HS	6422	14	BPR7HIX	5944
50	1	Flory RC 25 / 50	05-	0,60	BPR7HS	6422	14	BPR7HIX	5944
50	1	J 50 Junior, J 51 Junior	-	0,60	B6HS	4510	09	BR6HIX	3419
50	1	MC-5-50	-	0,50	B7HS	5110	03	BR7HIX	7067
50	1	MK	96-	0,60	BPR7HS	6422	14	BPR7HIX	5944
50	1	R 50	-	0,60	B7HS	5110	03	BR7HIX	7067
50	1	RMC E 25 / E 50 / F 25 / F 50	07-	0,70	BPR7HS	6422	14	BPR7HIX	5944
125	1	Enduro	00-	0,90	DP7EA-9	5629	13	DP7EIX-9	7803
125	1	Enduro	07-	0,70	CR8E	1275	04	CR8EIX	4218
125	1	Florett RMC 125	05-	0,50	CR7HSA	4549	07	CR7HIX	7544
125	1	Flory 125 4 temps	-	0,50	CR7HSA	4549	07	CR7HIX	7544
125	1	Mustang	-	0,70	DR8EA	7162	11	DR8EIX	6681
125	1	RMC F	07-	0,60	CR7HSA	4549	07	CR7HIX	7544
125	1	Supermoto	07-09	0,70	CR8E	1275	04	CR8EIX	4218
125	1	Supermoto DD	04-07	0,70	CR8E	1275	04	CR8EIX	4218
125	1	Supermoto DD	10-	0,70	CR8E	1275	04	CR8EIX	4218





KREIDLER-Quad

50	1	Mini Mustang, Mustang	05-	0,80	BPR7HS	6422	14	BPR7HIX	5944
100	1	F-Kart 100	05-	0,80	BPR7HS	6422	14	BPR7HIX	5944
170	1	Mustang 170, Mustang 200	05-	0,70	DR8EA	7162	11	DR8EIX	6681
250	1	Mustang 250	05-	0,70	CR8HS	7423	-	-	-

KTM

50	1	Chrono 50	-	0,50	BR7HS	4122	03	BR7HIX	7067
50	1	Cross 50 AC (Minarelli)	-	0,60	BR8HS	4322	01	BR8HIX	7001
50	1	Go 50, K 50	-	0,50	BR7HS	4122	03	BR7HIX	7067
50	1	K-Serie AC (Minarelli), K-Serie LC (Minarelli)	-	0,60	BR8HS	4322	01	BR8HIX	7001
50	1	LC Junior / Senior Adventure	01-	0,60	BR8ECM	3035	-	BR8ECMIX	3520
50	1	SX 2	-	0,60	B8HS	5510	01	BR8HIX	7001
50	1	SX 3	-	0,60	B6HS	4510	09	BR6HIX	3419
50	1	SX Mini	10-	0,70	LR8B	6208	-	-	-
50	1	SXR Pro-Junior	97-	0,60	B6HS	4510	09	BR6HIX	3419
50	1	SXR Pro-senior	99-	0,60	B8HS	5510	01	BR8HIX	7001
60	1	SX	99-	0,60	B105EGV	2171	-	-	-
65	1	CR 2 Temps	08-	0,60	BR8ECM	3035	-	BR8ECMIX	3520
65	1	SX	99-07	0,60	B105EGV	2171	-	-	-
65	1	SX	08-	0,60	BR8ECM	3035	-	BR8ECMIX	3520
85	1	SX	04-06	0,60	-	-	-	BR10ECMIX	3006
85	1	SX	07-	0,60	-	-	-	BR9EIX	3981
85	1	SX 17/14 - 19/16	10-	0,80	-	-	-	BR9ECMIX	2707
105	1	SX	07-	0,60	-	-	-	BR9EIX	3981
125	1	Duke	98-	0,70	BR9ES	5722	02	BR9EIX	3981
125	1	Duke	11-	0,90	LKAR8A-9	4786	-	-	-
125	1	Sting	97-	0,70	BR9ES	5722	02	BR9EIX	3981
125	1	Supermoto	01-	0,60	BR8HS	4322	01	BR8HIX	7001
125	1	EGS	93-	0,60	B10EGV	5927	-	-	-
125	1	EGS	98-00	0,60	R6918B-8	4492	-	-	-
125	1	EXC	93-97	0,60	B10EGV	5927	-	-	-
125	1	EXC	98-00	0,60	R6918B-8	4492	-	-	-
125	1	EXC	00-07	0,60	-	-	-	BR9EIX	3981
125	1	EXC	04-	0,60	-	-	-	BR10ECMIX	3006
125	1	EXC Six Day	08-	0,60	-	-	-	BR9ECMIX	2707
125	1	EXE	00-	0,60	BR8HS	4322	01	BR8HIX	7001
125	1	GS Culot court	-	0,60	B8HS	5510	01	BR8HIX	7001
125	1	GS Culot long	-	0,60	B10EGV	5927	-	-	-
125	1	LC2	96-99	0,70	BR9ES	5722	02	BR9EIX	3981
125	1	RC1	09-	0,60	-	-	-	BR9ECMIX	2707
125	1	SM	-	0,60	BR8HS	4322	01	BR8HIX	7001

CYL.	Nb Cyl.	TYPE	MODÈLE		INFO			N° STOCK	N° BLISTER		N° STOCK IX
125	1	SX		95-97		0,60	BR10EG	3830	-	-	-
125	1	SX		98-00		0,60	R6918B-8	4492	-	-	-
125	1	SX		01-07		0,60	-	-	-	BR9EIX	3981
125	1	SX		08-		0,60	-	-	-	BR9ECMIX	2707
144	1	SX		08-		0,60	-	-	-	BR9ECMIX	2707
150	1	SX		10-		0,80	-	-	-	BR9ECMIX	2707
150	1	XC		10-		0,60	-	-	-	BR9ECMIX	2707
200	1	EGS		98-		0,60	BR8EG	3130	-	-	-
200	1	EXC		98-		0,60	BR8EG	3130	-	-	-
200	1	EXC		10-		0,60	BR8EG	3130	-	-	-
200	1	SX		04-		0,60	-	-	-	BR9EIX	3981
200	1	XC-W		10-		0,60	BR8EG	3130	-	-	-
200		Duke		11-		0,90	LKAR8A-9	4786	-	-	-
200		EGS, EXC, MXC		98-		0,60	BR8EG	3130	-	-	-
250	1	EGS		97-02		0,60	BR8ECM	3035	-	BR8ECMIX	3520
250	1	EXC		93-95		0,60	B9EGV	5827	-	-	-
250	1	EXC		95-97		0,60	BR9EG	3230	-	-	-
250	1	EXC	Enduro Competition / 2 Temps	04-		0,60	BR7ES	5122	-	BR7EIX	6664
250	1	EXC	E-Starter	10-		0,80	BR7ES	5122	-	BR7EIX	6664
250	1	EXC	F 4 Temps	07-		0,80	CR9EKB	2305	-	CR9EIX	3521
250	1	EXC	Racing	97-		0,60	BR8ECM	3035	-	BR8ECMIX	3520
250	1	EXC	Racing GS / 4 Temps	04-		0,60	DCPR8E	4339	-	DCPR8EIX	6546
250	1	EXC	Six Days	10-		0,80	BR7ES	5122	-	BR7EIX	6664
250	1	EXC-F	Six Days	10-		0,80	CR9EKB	2305	-	CR9EIX	3521
250	1	GS	Culot court 14x12,7mm	-		0,60	B9HS	5810	-	BR9HIX	5687
250	1	GS	Culot long 14x19mm	-		0,60	B9EGV	5827	-	-	-
250	1	MX		-		0,60	B9EGV	5827	-	-	-
250	1	SX		93-95		0,60	B9EGV	5827	-	-	-
250	1	SX		96-97		0,60	BR8EG	3130	-	-	-
250	1	SX		97-		0,60	BR8ECM	3035	-	BR8ECMIX	3520
250	1	SX	F 4 Temps	05-		0,80	CR9EKB	2305	-	CR9EIX	3521
250	1	SXF		13-		0,70	LMAR9AI-8	97225	-	-	-
250	1	TVC		-		0,60	BR8ECM	3035	-	BR8ECMIX	3520
250	1	XC		10-		0,80	BR7ES	5122	-	BR7EIX	6664
250	1	XC-W		10-		0,80	BR7ES	5122	-	BR7EIX	6664
250	1	XCF-W	Champion's Edition	10-		0,80	CR9EKB	2305	-	CR9EIX	3521
300	1	EGS		97-		0,60	BR8ECM	3035	-	BR8ECMIX	3520
300	1	EXC	EGS	93-95		0,60	B9EGV	5827	-	-	-
300	1	EXC		96-		0,60	BR8EG	3130	-	-	-
300	1	EXC		97-02		0,60	BR8ECM	3035	-	BR8ECMIX	3520
300	1	EXC	Enduro Competition	04-		0,60	BR7ES	5122	-	BR7EIX	6664
300	1	EXC	Six Days	10-		0,80	BR7ES	5122	-	BR7EIX	6664
300	1	GS		-		0,60	B9EGV	5827	-	-	-
300	1	SX		-		0,60	B9EGV	5827	-	-	-
300	1	TVC		-		0,60	BR8ECM	3035	-	BR8ECMIX	3520
300	1	XC		06-		0,80	BR7ES	5122	-	BR7EIX	6664
300	1	XC-W		10-		0,80	BR7ES	5122	-	BR7EIX	6664
350	1	Freeride		12-		1,00	LMAR9AI-10	93188	-	-	-
350	1	EXC		11-		0,80	LMAR9AI-8	97225	-	-	-
350	1	MX		10-		0,80	LMAR9AI-8	97225	-	-	-
350	1	SX-F		10-		0,80	LMAR9AI-8	97225	-	-	-
350	1	XC-F		11-		0,80	LMAR9AI-8	97225	-	-	-
360	1	EXC		96-		0,60	BR8EG	3130	-	-	-
360	1	EXC		97-		0,60	BR8ECM	3035	-	BR8ECMIX	3520
360	1	SX		96-		0,60	BR8EG	3130	-	-	-
360	1	SX		97-		0,60	BR8ECM	3035	-	BR8ECMIX	3520
375	1	EXC	Racing	09-		0,90	LKAR8A-9	4786	-	-	-
380	1	EXC		98-		0,60	BR8ECM	3035	-	BR8ECMIX	3520
380	1	SX		98-		0,60	BR8ECM	3035	-	BR8ECMIX	3520
390	1	FE		10-		0,90	LKAR8AI-9	6706	-	-	-
400	1	EXC		02-		0,60	DCPR8E	4339	-	DCPR8EIX	6546
400	1	EXC		10-		0,90	LKAR8AI-9	6706	-	-	-
400	1	LC4	EGS / SC / SXC	93-99		0,60	D8EA	2120	11	DR8EIX	6681
400	1	LC4	EGS-E, LES	97-99		0,60	DR8EA	7162	11	DR8EIX	6681
400	1	LC4	E	99-		0,60	DR8EA	7162	11	DR8EIX	6681
400	1	LC4	SX / EXC Racing	00-		0,80	CR8EK	3478	-	CR8EIX	4218
400	1	XC	W	07-		0,60	DCPR8E	4339	-	DCPR8EIX	6546
400	1	XC-W		10-		0,90	LKAR8AI-9	6706	-	-	-
450	1	EXC	Racing, Racing GS	02-		0,60	DCPR8E	4339	-	DCPR8EIX	6546
450	1	EXC	R	07-		0,90	LKAR8A-9	4786	-	-	-
450	1	EXC	Six Days	10-		0,90	LKAR8AI-9	6706	-	-	-
450	1	FX		10-		0,90	LKAR8AI-9	6706	-	-	-
450	1	FE		10-		0,90	LKAR8AI-9	6706	-	-	-
450	1	MXC	Dessert	04-		0,60	DCPR8E	4339	-	DCPR8EIX	6546
450	1	SMR		05-		0,60	DCPR8E	4339	-	DCPR8EIX	6546

CYL.	Nb Cyl.	TYPE	MODÈLE		INFO			N° STOCK	N° BLISTER		N° STOCK IX
450	1	SX	F	07-		0,80	CR9EKB	2305	-	CR9EIX	3521
450	1	SX	Racing	03-		0,70	DCPR8E	4339	-	DCPR8EIX	6546
450	1	SX-F	Factory Repl.Nagl Edition	10-		0,80	CR9EKB	2305	-	CR9EIX	3521
450	1	XC	W	07-		0,60	DCPR8E	4339	-	DCPR8EIX	6546
450	1	XC-W	Six Days	10-		0,90	LKAR8AI-9	6706	-	-	-
505	1	SX	F	07-		0,70	CR9EKB	2305	-	CR9EIX	3521
520	1	EXC	Racing	00-		0,80	CR8EK	3478	-	CR8EIX	4218
520	1	LC4	SX	00-		0,80	CR8EK	3478	-	CR8EIX	4218
525	1	EXC	EXC Racing GS	04-06		0,60	DCPR8E	4339	-	DCPR8EIX	6546
525	1	EXC		07-		0,60	DCPR8E	4339	-	DCPR8EIX	6546
525	1	MXC	MXC / Desert Racing	04-		0,60	DCPR8E	4339	-	DCPR8EIX	6546
525	1	SMR	SMR	05-		0,60	DCPR8E	4339	-	DCPR8EIX	6546
525	1	SX	Racing	03-		0,70	DCPR8E	4339	-	DCPR8EIX	6546
525	1	XC	W	07-		0,60	DCPR8E	4339	-	DCPR8EIX	6546
530	1	EXC	R	07-		0,70	LKAR8A-9	4786	-	-	-
530	1	EXC	Six Days	10-		0,90	LKAR8AI-9	6706	-	-	-
530	1	XC-W	Six Days	10-		0,90	LKAR8AI-9	6706	-	-	-
540	1	LC4	SXC	98-99		0,60	D8EA	2120	11	DR8EIX	6681
570	1	FE		10-		0,90	LKAR8AI-9	6706	-	-	-
570	1	FS		10-		0,90	LKAR8AI-9	6706	-	-	-
620	1	LC4	Duke	95-		0,60	D8EA	2120	11	DR8EIX	6681
620	1	LC4	Duke-E	96-98		0,60	DR8EA	7162	11	DR8EIX	6681
620	1	LC4	EGS	93-97		0,60	D8EA	2120	11	DR8EIX	6681
620	1	LC4	EGS-E, LES	97-98		0,60	DR8EA	7162	11	DR8EIX	6681
620	1	LC4	EGS-E, LES	99-		0,90	DPR8EA-9	4929	08	DPR8EIX-9	2202
620	1	LC4	Rallye	97-98		0,60	D8EA	2120	11	DR8EIX	6681
620	1	LC4	Rallye	99-		0,90	DPR8EA-9	4929	08	DPR8EIX-9	2202
620	1	LC4	SC	95-97		0,60	D8EA	2120	11	DR8EIX	6681
620	1	LC4	Supercomp / Supermoto	99-		0,90	DPR8EA-9	4929	08	DPR8EIX-9	2202
620	1	LC4	SX	95-98		0,60	D8EA	2120	11	DR8EIX	6681
625	1	SC	Enduro, Super Moto	00-		0,70	DCPR8E	4339	-	DCPR8EIX	6546
625	1	SMC		05-		0,60	DCPR8E	4339	-	DCPR8EIX	6546
640	1	LC4	Duke	05-		0,60	DCPR8E	4339	-	DCPR8EIX	6546
640	1	LC4	Adventure R	99-		0,60	D8EA	2120	11	DR8EIX	6681
640	1	LC4	Adventure R	00-		0,90	DPR8EA-9	4929	08	DPR8EIX-9	2202
640	1	LC4	Duke II	99-		0,60	DR8EA	7162	11	DR8EIX	6681
640	1	LC4	Duke II	00-		0,90	DPR8EA-9	4929	08	DPR8EIX-9	2202
640	1	LC4	E / E Supermoto	99-		0,60	D8EA	2120	11	DR8EIX	6681
640	1	LC4	E / E Supermoto	00-		0,90	DPR8EA-9	4929	08	DPR8EIX-9	2202
640	1	LC4	Rallye	98-		0,60	D8EA	2120	11	DR8EIX	6681
640	1	LC4	SM	05-		0,60	DCPR8E	4339	-	DCPR8EIX	6546
654	1		690 LC4 Supermoto / Prestige	07-		0,90	LKAR8AI-9	6706	-	-	-
660	1		SMC	03-		0,70	DCPR8E	4339	-	DCPR8EIX	6546
660	1		SMC	07-		0,90	LKAR8AI-9	6706	-	-	-
660	1	LC4	Rallye	99-		0,70	DR9EA	3437	-	DR9EIX	4772
690	1		Duke, Duke R	10-		0,90	LKAR8AI-9	6706	-	-	-
690	1		Duke	12-	2 Bougies par Cylindre	0,90 +0,90	LKAR8BI9 +LMAR7A-9	1553 +4908	-	-	-
690	1		SM	-		0,90	LKAR8AI-9	6706	-	-	-
690	1		Enduro R	08-		0,90	LKAR8AI-9	6706	-	-	-
690	1	SMC		10-		0,90	LKAR8AI-9	6706	-	-	-
780	1	EXC		07-11		0,90	LKAR8A-9	4786	-	-	-
950	2		Adventure, Adventure S	04-		0,70	CR8EK	3478	-	CR8EIX	4218
950	2		Enduro	06-		0,70	CR8EK	3478	-	CR8EIX	4218
950	2		LC8 Rally	04-07		0,70	CR8EK	3478	-	CR8EIX	4218
950	2		LC8	07-		0,80	KR8DI	4742	-	-	-
950	2		Super Enduro R	-		0,70	CR8EK	3478	-	CR8EIX	4218
950	2		Superduke	05-		0,60	DCPR8E	4339	-	DCPR8EIX	6546
950	2		Supermoto	05-06		0,70	CR8EK	3478	-	CR8EIX	4218
950	2		Supermoto R	07-		0,70	CR8EK	3478	-	CR8EIX	4218
990	2		Adventure / ABS, R	10-		0,90	LKAR8BI9	1553	-	-	-
990	2		Super Duke	05-		0,70	CR8EK	3478	-	CR8EIX	4218
990	2		Super Duke R	-		0,60	DCPR8E	4339	-	DCPR8EIX	6546
990	2	LC8	Super Duke R	10-		0,90	LKAR8AI-9	6706	-	-	-
990	2		Super Duke, Super Duke R	07-		0,80	KR8DI	4742	-	-	-
990	2		Supermoto R / T silver / orange	10-		0,80	KR8DI	4742	-	-	-
999	2	SM	Adventure R	09-		0,60	DCPR8E	4339	-	DCPR8EIX	6546
999	2	SM	Supermoto R	09-		0,70	CR8EK	3478	-	CR8EIX	4218
1150	2	RC8	1190	08-		0,90	LKAR9BI9	6205	-	-	-
1150	2	RC8	4 Temps	10-		0,90	LKAR9BI9	6205	-	-	-
1190	2	RC8	1190 R Red Bull, 1190 R Akrapovic Ed	10-	2 Bougies par Cylindre	0,90 +0,90	LKAR9BI9 +LMAR7A-9	6205 +4908	-	-	-
1190	2	RC8	1190	10-	2 Bougies par Cylindre	0,90 +0,90	LKAR9BI9 +LMAR7A-9	6205 +4908	-	-	-
1200	2	RC8R	R	11-	2 Bougies par Cylindre	0,90	LKAR9BI9	6205	-	-	-

CYL. Nb Cyl. TYPE MODÈLE



INFO



N° STOCK

N° BLISTER



N° STOCK IX



KTM - Quad

450	1	SX	450	09-	0,70	CR9EKB	2305	-	CR9EIX	3521
450	1	XC		08-	0,90	DCPR8E	4339	-	DCPR8EIX	6546
477	1	SX	505	09-	0,70	CR9EKB	2305	-	CR9EIX	3521
510	1	XC	525	08-	0,60	DCPR8E	4339	-	DCPR8EIX	6546
525	1	XC		08-	0,90	DCPR8E	4339	-	DCPR8EIX	6546







KUANG YANG

50	1		GS7E - Movie, KA 50, KA 50G	-	0,60	BP6HSA	1046	-	BPR6HIX	4085
----	---	--	-----------------------------	---	------	--------	------	---	---------	------



KYMCO





50	1		Agility 50 4 Temps, Agility 50 MMC 4 Temps	05-	0,60	CR7HSA	4549	07	CR7HIX	7544
50	1		Agility Basic 50 / City 50 / One 50	-	0,60	CR7HSA	4549	07	CR7HIX	7544
50	1		Agility R10 / R12 / R16 / RS	-	0,70	CR7HSA	4549	07	CR7HIX	7544
50	1		Bet&Win 50LC	-	0,70	BR8HSA	5539	-	BR8HIX	7001
50	1		Calypso 50	97-	0,60	BR8HS	4322	01	BR8HIX	7001
50	1	Cobra	Cross / Racer / Exclusive	97-	0,60	BR8HSA	5539	-	BR8HIX	7001
50	1		Curio	96-	0,70	BR8HSA	5539	-	BR8HIX	7001
50	1		Dink 2 Temps	99-06	0,70	BR8HSA	5539	-	BR8HIX	7001
50	1		Dink 4 Temps	06-	0,70	CR7HSA	4549	07	CR7HIX	7544
50	1		Dink 50 LC, Grand Dink 50s	-	0,70	BR8HSA	5539	-	BR8HIX	7001
50	1		Heroism	96-	0,70	BR8HSA	5539	-	BR8HIX	7001
50	1		Like 2 Temps	09-	0,70	BR8HSA	5539	-	BR8HIX	7001
50	1		Like 4 Temps	09-	0,50	CR7HSA	4549	07	CR7HIX	7544
50	1		Nexxon 50	-	0,60	CR7HSA	4549	07	CR7HIX	7544
50	1		People / S2 Temps	99-	0,70	BR8HSA	5539	-	BR8HIX	7001
50	1		People S 50 4T	06-	0,60	CR7HSA	4549	07	CR7HIX	7544
50	1		Sento	09-	0,50	CR7HSA	4549	07	CR7HIX	7544
50	1		Sniper 50	93-	0,60	BR8HSA	5539	-	BR8HIX	7001
50	1		Snuper 50 DD	-	0,60	BR8HSA	5539	-	BR8HIX	7001
50	1		Spacer 50	99-	0,60	BR8HSA	5539	-	BR8HIX	7001
50	1		Super 8 2 Temps	09-	0,70	BR8HSA	5539	-	BR8HIX	7001
50	1		Super 8 4 Temps	08-	0,50	CR7HSA	4549	07	CR7HIX	7544
50	1		Super 9 AC 50 Sports	01-	0,60	BR8HSA	5539	-	BR8HIX	7001
50	1		Super 9 LC	00-	0,70	BR8HSA	5539	-	BR8HIX	7001
50	1		Spacer	98-	0,70	BR6HSA	4296	-	BR6HIX	3419
50	1		Tomos Classic / Quadro / Flexer	01-	0,60	B6HS	4510	09	BR6HIX	3419
50	1		Top Boy 50	01-	0,60	BR8HSA	5539	-	BR8HIX	7001
50	1		Vitality 2 Temps	05-	0,60	BR8HSA	5539	-	BR8HIX	7001
50	1		Vitality 4 Temps	05-	0,50	CR7HSA	4549	07	CR7HIX	7544
50	1		Vitality 50 Cross, Vitality 50 Sports	-	0,60	BR8HSA	5539	-	BR8HIX	7001
50	1		Yager 50 2 Temps	01-	0,60	BR8HSA	5539	-	BR8HIX	7001
50	1		Yager GT 50	-	0,60	CR7HSA	4549	07	CR7HIX	7544
50	1		Yup	00-	0,70	BR8HSA	5539	-	BR8HIX	7001
50	1	CSX		-	0,60	BR8HSA	5539	-	BR8HIX	7001
50	1	CX	/Super	-	0,60	BR8HSA	5539	-	BR8HIX	7001
50	1	DJ		-	0,70	BR8HSA	5539	-	BR8HIX	7001
50	1	Filly	LX	-	0,70	CR7HSA	4549	07	CR7HIX	7544
50	1	K12	SC10AE	96-	0,70	BR8HSA	5539	-	BR8HIX	7001
50	1	KB		-	0,60	BR8HSA	5539	-	BR8HIX	7001
50	1	RS	Renovo 2 temps	-	0,70	BR8HSA	5539	-	BR8HIX	7001
50	1	ZX	Scout	96-	0,70	BR8HSA	5539	-	BR8HIX	7001
50	1	ZX	Fever 10 pouces	-	0,70	BR7HS	4122	03	BR7HIX	7067
50	1	ZX	Fever 12 pouces	96-	0,70	BR8HSA	5539	-	BR8HIX	7001
100	1		Cobra Racer	98-	0,70	BR6HSA	4296	-	BR6HIX	3419
125	1		Agility, Agility R16, Agility RS	05-	0,70	CR7HSA	4549	07	CR7HIX	7544
125	1		Calypso 125	97-	0,60	C7HSA	4629	07	CR7HIX	7544
125	1		CK	05-	0,70	DR8EA	7162	11	DR8EIX	6681
125	1		Cruiser	-	0,70	CR8E	1275	04	CR8EIX	4218
125	1		Dink 4 Temps / DD	99-	0,90	DPR7EA-9	5129	13	DPR7EIX-9	7803
125	1		Downtown i	09-	0,80	CR7E	4578	12	CR7EIX	7385
125	1		Ego	00-	0,90	DPR7EA-9	5129	13	DPR7EIX-9	7803
125	1		Grand Dink	01-	0,90	DPR7EA-9	5129	13	DPR7EIX-9	7803
125	1		Heroism	-	0,70	CR7HSA	4549	07	CR7HIX	7544
125	1		Hipster	00-	0,70	DR8EA	7162	11	DR8EIX	6681
125	1		Hipster (4 Soupapes)	-	0,70	CR8E	1275	04	CR8EIX	4218
125	1		K-XCT	13-	0,70	CR7E	4578	12	CR7EIX	7385
125	1		Like	09-	0,70	CR7HSA	4549	07	CR7HIX	7544
125	1		Météorit	-	0,70	DR8EA	7162	11	DR8EIX	6681

CYL.	Nb Cyl.	TYPE	MODÈLE		INFO			N° STOCK	N° BLISTER		N° STOCK IX
125	1	Movie	125 4 Temps	-	0,60		C7HSA	4629	07	CR7HIX	7544
125		Movie	XL	02-	0,70		CR7HSA	4549	07	CR7HIX	7544
125	1	Quannon	Naked	10-	0,70		CR8E	1275	04	CR8EIX	4218
125	1	People		99-04	0,70		DR8EA	7162	11	DR8EIX	6681
125	1	People	125 E3 / S 125 DD	08-	0,70		CR7HSA	4549	07	CR7HIX	7544
125	1	People	People S	05-	0,70		CR7HSA	4549	07	CR7HIX	7544
125	1	People	GTi	10-	0,70		CR7HSA	4549	07	CR7HIX	7544
125	1	Pulsar		01-	0,70		DR8EA	7162	11	DR8EIX	6681
125	1	Sector		98-	0,70		DR8EA	7162	11	DR8EIX	6681
125	1	Spacer		97-	0,90		DPR7EA-9	5129	13	DPR7EIX-9	7803
125	1	Super 8		08-	0,70		CR7HSA	4549	07	CR7HIX	7544
125	1	Super 8-125		-	0,90		DPR7EA-9	5129	13	DPR7EIX-9	7803
125	1	Vivio		99-	0,70		CR7HSA	4549	07	CR7HIX	7544
125	1	Yager	125 4 Temps	01-	0,90		DPR7EA-9	5129	13	DPR7EIX-9	7803
125	1	Yager	GT 125	08-	0,90		DPR7EA-9	5129	13	DPR7EIX-9	7803
125	1	Zing		97-	0,70		DR8EA	7162	11	DR8EIX	6681
125	1	Zing	II	08-	0,70		DR8EA	7162	11	DR8EIX	6681
125	1	Stryker	On / Off Road	99-	0,70		DR8EA	7162	11	DR8EIX	6681
150	1	Agility	R16	08-	0,70		CR7HSA	4549	07	CR7HIX	7544
150	1	Heroism		96-	0,70		CR7HSA	4549	07	CR7HIX	7544
150	1	People		99-	0,90		DPR7EA-9	5129	13	DPR7EIX-9	7803
200	1	People S	200i / S 200 DD	08-	0,70		CR7HSA	4549	07	CR7HIX	7544
200	1	Dink	DD	08-	0,90		DPR6EA-9	5531	-	-	-
200	1	Agility	R16	10-	0,70		CR7HSA	4549	07	CR7HIX	7544
200	1	Downtown	i	10-	0,70		CR7E	4578	12	CR7EIX	7385
200	1	Like	i	09-	0,70		CR7HSA	4549	07	CR7HIX	7544
200	1	People S	200i	07-	0,60		CR7HSA	4549	07	CR7HIX	7544
200	1	People	GT 200i	10-	0,70		CR7E	4578	12	CR7EIX	7385
250	2	Ego		00-	0,90		DPR7EA-9	5129	13	DPR7EIX-9	7803
250	1	Grand	Dink	01-	0,90		DPR7EA-9	5129	13	DPR7EIX-9	7803
250	2	People		03-	0,90		DPR7EA-9	5129	13	DPR7EIX-9	7803
200	1	People S	250i	07-	0,90		DPR6EA-9	5531	-	-	-
250	2	Venox		02-	0,80		CR8E	1275	04	CR8EIX	4218
250	2	Xciting		05-	0,90		DPR7EA-9	5129	13	DPR7EIX-9	7803
250	1	People S	300i	07-	0,90		DPR6EA-9	5531	-	-	-
300		Downtown	i	09-	0,80		CR7E	4578	12	CR7EIX	7385
300		People	S	08-	0,90		DPR6EA-9	5531	-	-	-
300	1	People	GT i	10-	0,80		CR7E	4578	12	CR7EIX	7385
300	1	Xciting	R	-	0,90		CPR6EA-9	6899	-	-	-
300		Xciting	i R	09-	0,90		DPR6EA-9	5531	-	-	-
500	1	Xciting		05-	0,80		CR8E	1275	04	CR8EIX	4218
500	1	Xciting	i	07-	0,70		CR7E	4578	12	CR7EIX	7385



KYMCO - Quad

50	1	Calypso		97-	0,60		BR8HS	4322	01	BR8HIX	7001
50	1	Fever	ZX	-	0,60		BR8HSA	5539	-	BR8HIX	7001
50	1	Grand	Dink 2 Temps	05-	0,60		BR8HSA	5539	-	BR8HIX	7001
50	1	Heroism	, K 12, KB	-	0,60		BR8HSA	5539	-	BR8HIX	7001
50	1	KXR		04-	0,70		BR8HSA	5539	-	BR8HIX	7001
50	1	MX		01-	0,50		BR8HSA	5539	-	BR8HIX	7001
50	1	Mxer	(4x2)	02-	0,70		BR8HSA	5539	-	BR8HIX	7001
50	1	MXU		05-	0,50		BR8HSA	5539	-	BR8HIX	7001
50	1	People		99-	0,60		BR8HSA	5539	-	BR8HIX	7001
50	1	Scout		97-	0,60		BR8HSA	5539	-	BR8HIX	7001
50	1	Snuper	DD	-	0,60		BR8HSA	5539	-	BR8HIX	7001
50	1	Tomos	Classic/Quadro/Flexer/TX	01-	0,60		B6HS	4510	09	BR6HIX	3419
90	1	KXR		-	0,50		C7HSA	4629	07	CR7HIX	7544
100	1	Cobra	Racer	99-	0,60		BR8HSA	5539	-	BR8HIX	7001
125	1	Agility		05-	0,70		CR7HSA	4549	07	CR7HIX	7544
125	1	Calypso		97-	0,60		C7HSA	4629	07	CR7HIX	7544
125	1	CK		04-	0,70		DR8EA	7162	11	DR8EIX	6681
125	1	Dink	4 Temps, Grand Dink 4 Temps	99-	0,90		DPR7EA-9	5129	13	DPR7EIX-9	7803
125	1	Heroism		-	0,70		C7HSA	4629	07	CR7HIX	7544
125	1	Hipster	2 Temps	01-	0,70		DR8EA	7162	11	DR8EIX	6681
125	1	Hipster	4 Temps	01-	0,60		CR8E	1275	04	CR8EIX	4218
125	1	Movie	4 Temps	-	0,60		C7HSA	4629	07	CR7HIX	7544
125	1	People		05-	0,60		C7HSA	4629	07	CR7HIX	7544
125	1	Pulsar	4 Temps	01-	0,70		DR8EA	7162	11	DR8EIX	6681
125	1	Spacer		97-	0,90		DPR7EA-9	5129	13	DPR7EIX-9	7803
125	1	Stryker	, Stryker II	99-	0,70		DR8EA	7162	11	DR8EIX	6681
125	1	Yager	4 Temps	01-	0,90		DPR7EA-9	5129	13	DPR7EIX-9	7803
125	1	Zing		97-	0,60		DR8EA	7162	11	DR8EIX	6681
150	1	Heroism		-	0,70		C7HSA	4629	07	CR7HIX	7544

CYL.	Nb Cyl.	TYPE	MODÈLE		INFO			N° STOCK	N° BLISTER		N° STOCK IX
150	1	Mxer (4x2)		02-		0,70	DR8EA	7162	11	DR8EIX	6681
150	1	MX		01-		0,70	DR8EA	7162	11	DR8EIX	6681
150	1	MXU		-		0,70	DR8EA	7162	11	DR8EIX	6681
250	1	Dink / Grand Dink 4 Temps		99-		0,90	DPR7EA-9	5129	13	DPR7EIX-9	7803
250	1	KXR		01-		0,90	DPR7EA-9	5129	13	DPR7EIX-9	7803
250	1	Maxxer, Mxer 250R, MXU, People		05-		0,90	DPR7EA-9	5129	13	DPR7EIX-9	7803
250	1	Venox 4 Temps		01-		0,90	DPR7EA-9	5129	13	DPR7EIX-9	7803
250	1	Xciting		05-		0,90	DPR7EA-9	5129	13	DPR7EIX-9	7803
300	1	Maxxer, MXU		05-		0,90	DPR7EA-9	5129	13	DPR7EIX-9	7803
300	1	Xciting R		-		0,90	CPR6EA-9	6899	-	-	-
400	1	MXU		08-		0,90	CR8E	1275	04	CR8EIX	4218
500	1	MXU		05-		0,80	CR7E	4578	12	CR7EIX	7385
500	1	MXU 4x4		06-		0,60	CR8E	1275	04	CR8EIX	4218

KYMCO - SSV

500	1	UXV		08-		0,90	DPR7EA-9	5129	13	DPR7EIX-9	7803
500	1	UXV		-		0,60	CR7E	4578	12	CR7EIX	7385

LAVERDA

650		Sport		95-		0,60	DCPR8E	4339	-	DCPR8EIX	6546
650	2	Ghost, Ghost Strike, Formula		96-		0,60	DCPR8E	4339	-	DCPR8EIX	6546
650		650, GT, GTL, American Eagle		94-98		0,70	B9ES	2611	02	BR9EIX	3981
668	2			96-		0,60	DCPR8E	4339	-	DCPR8EIX	6546
750		Black Strike		00-		0,60	DCPR8E	4339	-	DCPR8EIX	6546
750		Diamant, Formula		97-		0,60	DCPR8E	4339	-	DCPR8EIX	6546
750		Ghost, Strike, Sport		98-		0,60	DCPR8E	4339	-	DCPR8EIX	6546
750		750, GT, GTL, American Eagle		-		0,70	B8ES	2411	05	BR8EIX	5044
750		S		97-		0,60	DCPR8E	4339	-	DCPR8EIX	6546
750		SS		00-		0,60	DCPR8E	4339	-	DCPR8EIX	6546

LEM - Quad

50	1	Cayman (4x2), Condor (4x2)		97-		0,70	BR8HS	4322	01	BR8HIX	7001
----	---	----------------------------	--	-----	--	------	-------	------	----	--------	------

LINGBEN

125	1	Manhattan		06-		0,70	CR7HSA	4549	07	CR7HIX	7544
-----	---	-----------	--	-----	--	------	--------	------	----	--------	------

LINHAI / HYTRACK - Quad

257	1	260 Yéti Standard, 260 Yéti Sport		-		0,60	DR8EA	7162	11	DR8EIX	6681
260	1			05-		0,70	DR8EA	7162	11	DR8EIX	6681





MAICO

-		Modèles culot court		-		0,50	-	-	-	BR9HIX	5687
250		Cross, Enduro		90-		0,50	B9EG	3530	-	-	-
320		Cross, Enduro		90-		0,50	B9EG	3530	-	-	-
360		Cross, Enduro		92-		0,50	B9EG	3530	-	-	-
380		Cross, Enduro		91-		0,50	B9EG	3530	-	-	-
440		Cross, Enduro		92-		0,50	B9EG	3530	-	-	-
500		Cross, Enduro		90-		0,50	B9EG	3530	-	-	-
610		Side Car		91-		0,50	B8EG	3430	-	-	-
640	2	Bi Cylindre Side Car		91-		0,50	B9EG	3530	-	-	-

MALAGUTI

50	1	Centro, Centro SL		92-		0,50	BR7HS	4122	03	BR7HIX	7067
50	1	Centro		00-		0,70	BR8HS	4322	01	BR8HIX	7001
50	1	Centro 4 Temps		08-		0,70	PMR7A	4259	-	-	-
50	1	Centro 50 SL 4T		10-		0,70	PMR7A	4259	-	-	-
50	1	Centro Luxe		96-		0,50	BR7HS	4122	03	BR7HIX	7067
50	1	Ciak		-		0,50	DR8HS	5123	-	-	-
50	1	Ciak Master 2 Temps		99-		0,70	BR8HS	4322	01	BR8HIX	7001
50	1	Ciak Master 4 Temps		08-		0,70	PMR7A	4259	-	-	-
50	1	CR1, Crosser CR1		95-		0,50	BPR6HS	7022	-	BPR6HIX	4085
50	1	DVD 4T Malbonline		10-		0,70	PMR7A	4259	-	-	-
50	1	ET		-		0,60	B6HS	4510	09	BR6HIX	3419

MALAGUTI

CYL.	Nb Cyl.	TYPE	MODÈLE		INFO			N° STOCK	N° BLISTER		N° STOCK IX
50	1		Fifty Full, Fifty Top	-		0,50	B6HS	4510	09	BR6HIX	3419
50	1		Foggy Replica	-		0,50	BR8HS	4322	01	BR8HIX	7001
50	1		Phantom LC Tiger 50	93-		0,60	BR7HS	4122	03	BR7HIX	7067
50	1		Rannocchio	90-		0,50	B6HS	4510	09	BR6HIX	3419
50	1		Yesterday	98-		0,50	BR7HS	4122	03	BR7HIX	7067
50	1	F10		93-		0,50	BR7HS	4122	03	BR7HIX	7067
50	1	F10	Jet Line	92-		0,70	BR7HS	4122	03	BR7HIX	7067
50	1	F10	Jet Line Tigers	-		0,60	BR7HS	4122	03	BR7HIX	7067
50	1	F10	Jet Line Tribal	10-		0,50	BR7HS	4122	03	BR7HIX	7067
50	1	F10	Jet Line WAP	03-		0,60	BR7HS	4122	03	BR7HIX	7067
50	1	F11		-		0,70	BR8HS	4322	01	BR8HIX	7001
50	1	F12	Dragon	96-		0,50	BR7HS	4122	03	BR7HIX	7067
50	1	F12	Phantom & Luxe (ref. air)	00-		0,70	BR7HS	4122	03	BR7HIX	7067
50	1	F12	Phantom (ref. liquide)	00-		0,70	BR8HS	4322	01	BR8HIX	7001
50	1	F15	Ducati Corse	07-		0,70	BR8HS	4322	01	BR8HIX	7001
50	1	F15	Firefox, Sesame (ref.liquide)	96-		0,70	BR8HS	4322	01	BR8HIX	7001
50	1	F15	Firefox (ref.air)	05-		0,70	BR7HS	4122	03	BR7HIX	7067
50	1	MRX		-		0,50	BP7ES	2412	-	BPR7EIX	4055
50	1	RCW	Grizzly 4 vitesses	93-96		0,50	B8HS	5510	01	BR8HIX	7001
50	1	RCX 10	Grizzly	90-		0,50	B6HS	4510	09	BR6HIX	3419
50	1	RCX 12	Grizzly	90-		0,50	B8HS	5510	01	BR8HIX	7001
70		F69	Phantom	97-99		0,50	BR7HS	4122	03	BR7HIX	7067
100	1		Ciak	02-		0,50	BR7HS	4122	03	BR7HIX	7067
100	1	F12	Phantom	-		0,50	BR7HS	4122	03	BR7HIX	7067
125	1		Blog	09-		0,90	DPR7EA-9	5129	13	DPR7EIX-9	7803
125	1		Centro 4T	-		0,90	DPR7EA-9	5129	13	DPR7EIX-9	7803
125	1		Centro SL 4T	10-		0,90	DPR7EA-9	5129	13	DPR7EIX-9	7803
125	1		Ciak	01-		0,70	CR7HSA	4549	07	CR7HIX	7544
125	1		Madison	99-		0,70	CR8E	1275	04	CR8EIX	4218
125	1		Madison 3	-		0,60	CR8EB	7784	04	CR8EIX	4218
125	1	F18	Warrior 4 Temps	01-		0,90	DPR7EA-9	5129	13	DPR7EIX-9	7803
150	1		Ciak 150 4 Temps	-		0,70	CR7HSA	4549	07	CR7HIX	7544
150	1	T	Madison	-		0,70	CR8E	1275	04	CR8EIX	4218
160	1		Blog, Centro 4T	-		0,90	DPR7EA-9	5129	13	DPR7EIX-9	7803
160	1		Centro SL 4T	10-		0,90	DPR7EA-9	5129	13	DPR7EIX-9	7803
180		R	Madison	-01		0,70	CR9EB	6955	06	CR9EIX	3521
180		S	Madison	01-		0,70	CR8EB	7784	04	CR8EIX	4218
200	1		Madison S	03-		0,70	CR8EB	7784	04	CR8EIX	4218
200	1	F12	Phantom Max	04-		0,60	CR8EB	7784	04	CR8EIX	4218
250			Madison	99-04		0,90	DPR9EA-9	5329	-	DPR9EIX-9	5545
250	1		Madison 3	-		0,70	PMR8B	6378	-	-	-
250	1		Madison S	99-		0,60	DR8EA	7162	11	DR8EIX	6681
250	1		Password	-		0,90	DPR8EA-9	4929	08	DPR8EIX-9	2202
400	1	K	Madison	02-		0,80	CR7E	4578	12	CR7EIX	7385
400	1		Madison	03-		0,80	CR9E	6263	06	CR9EIX	3521
500	1		Spidermax 500 GT	04-		0,60	CR7EKB	4455	-	CR7EIX	7385
500	1		Spidermax 500 RS	10-		0,60	CR7EKB	4455	-	CR7EIX	7385



MANCO

50			Miny Indy 5hp & Stock Car 4hp Mot. Subaru	-		0,70	BR6HS	3922	09	BR6HIX	3419
50	1		ZSR-50	-		0,80	BPR7HS	6422	14	BPR7HIX	5944
90	1		ZSR-90	-		0,80	BPR7HS	6422	14	BPR7HIX	5944
126	1		Bandit Kart 4.0 hp Moteur Subaru	-		0,60	BR6HS	3922	09	BR6HIX	3419
126	1		Critter Kart 5.0 hp Moteur Subaru	-		0,70	BR6HS	3922	09	BR6HIX	3419
126	1		Eliminator / Force Five Kart 5hp Mot. Subaru	-		0,60	BR6HS	3922	09	BR6HIX	3419
126	1		Quicksilver Kart 5.0 hp Moteur Subaru	-		0,70	BR6HS	3922	09	BR6HIX	3419
169	1		Eliminator / EZ Kart 6.5 hp Moteur Subaru	-		0,70	BR6HS	3922	09	BR6HIX	3419
211			Aerforce / Intruder Kart 7.0 hp Moteur Subaru	-		0,70	BR6HS	3922	09	BR6HIX	3419
260			8260E	-		0,70	DR8EA	7162	11	DR8EIX	6681
265			Aerforce Kart 10.0 hp Robin Moteur Subaru	-		0,70	BR6HS	3922	09	BR6HIX	3419
404			XTK-713E 13.5 hp Robin Moteur Subaru	-		0,60	BR6HS	3922	09	BR6HIX	3419
450			618 Super Deuce 18.0 hp Honda V-Twin OHV	-		0,70	BPR5ES	7422	-	BPR5EIX	6597



MASAI - Quad

265	1		A300	-		1,00	DCPR7E	3932	-	DCPR7EIX	6046
450	1		A450	-		0,80	DCPR8E	4339	-	DCPR8EIX	6546



MASSEY FERGUSON - Quad

250	3	MF	2x4	-		0,70	DR7EA	7839	-	DR7EIX	5686
350		MF	MRP	-		0,70	DR7EA	7839	-	DR7EIX	5686

CYL.	Nb Cyl.	TYPE	MODÈLE		INFO			N° STOCK	N° BLISTER		N° STOCK IX
400		MF	MRP	-		0,70	CR6E	6965	-	-	-
450		MF	MRP	-		0,70	CR6E	6965	-	-	-
500		MF	MRP / TBX	-		0,70	CR6E	6965	-	-	-



MBK

50	1		Active	-		0,70	BPR7HS	6422	14	BPR7HIX	5944
50	1		Booster	90-94		0,60	BPR7HS	6422	14	BPR7HIX	5944
50	1		Booster	97-		0,60	BR8HS	4322	01	BR8HIX	7001
50	1		Booster "10 years Spécial"	00-		0,70	BR8HS	4322	01	BR8HIX	7001
50	1		Booster F1	-		0,70	BR8HS	4322	01	BR8HIX	7001
50	1		Booster NG	97-		0,60	BR8HS	4322	01	BR8HIX	7001
50	1		Booster Original, Booster Power Rocket	-		0,70	BR8HS	4322	01	BR8HIX	7001
50	1		Booster R 50	-		0,60	BR7HS	4122	03	BR7HIX	7067
50	1		Booster Road	-		0,70	BR7HS	4122	03	BR7HIX	7067
50	1		Booster Rocket / Track	97-		0,70	BR8HS	4322	01	BR8HIX	7001
50	1		Booster Spirit	-		0,70	BR8HS	4322	01	BR8HIX	7001
50	1		Booster Spirit SAS	99-		0,70	BR8HS	4322	01	BR8HIX	7001
50	1		Champ	-		0,70	BPR6HS	7022	-	BPR6HIX	4085
50	1		Champ 88, 89	-		0,70	B6HS	4510	09	BR6HIX	3419
50	1		Dakota	05-		0,70	BR7HS	4122	03	BR7HIX	7067
50	1		Equalis, Evolis, Business Class, Fizz	-		0,70	BR7HS	4122	03	BR7HIX	7067
50	1		Flipper	98-		0,60	BR8HS	4322	01	BR8HIX	7001
50	1		Forte	96-		0,60	BR8HS	4322	01	BR8HIX	7001
50	1		Hot Champ	-		0,70	BR7HS	4122	03	BR7HIX	7067
50	1		Kansas	05-		0,70	BR7HS	4122	03	BR7HIX	7067
50	1		Mach G (AC), Mach G (LC)	04-		0,70	BR8HS	4322	01	BR8HIX	7001
50	1		New Sorriso 50	95-		0,60	BP7HS	5111	14	BPR7HIX	5944
50	1		Nitro	97-		0,70	BR8HS	4322	01	BR8HIX	7001
50	1		Nitro F1 "Mc Laren"	00-		0,70	BR8HS	4322	01	BR8HIX	7001
50	1		Nitro Jaguar Racing	04-		0,70	BR8HS	4322	01	BR8HIX	7001
50	1		Ovetto	97-		0,70	BR7HS	4122	03	BR7HIX	7067
50	1		Ovetto 4	14-		0,80	CR7E	4578	12	CR7EIX	7385
50	1		Phoenix	05-		0,70	BR7HS	4122	03	BR7HIX	7067
50	1		Sorriso	-		1,00	BP7HS-10	7829	-	-	-
50	1		Stunt	99-		0,60	BR9HS	4522	-	BR9HIX	5687
50	1		Stunt	03-		0,60	BR8HS	4322	01	BR8HIX	7001
50	1		Target	-		0,60	BP7HS	5111	14	BPR7HIX	5944
50	1		X-Limit	96-04		0,70	BR8ES	5422	05	BR8EIX	5044
50	1		X-Limit	05-		0,70	BR9ES	5722	02	BR9EIX	3981
50	1		X-Power	96-		0,70	BR8ES	5422	05	BR8EIX	5044
50	1	51	V	-		0,70	B7HS	5110	03	BR7HIX	7067
50	1	51	Club Swing	-		0,70	B6HS	4510	09	BR6HIX	3419
50	1	51	Club, Club VR, Collection, Evasion	-		0,70	B7HS	5110	03	BR7HIX	7067
50	1	51	Jazz, Hard Rock	-		0,70	B7HS	5110	03	BR7HIX	7067
50	1	51	Mag Max	-		0,70	B8ES	2411	05	BR8EIX	5044
50	1	51	Magnum Racing	-		0,70	B6HS	4510	09	BR6HIX	3419
50	1	51	Magnum Racing XR (ref.liquide)	-		0,70	B8ES	2411	05	BR8EIX	5044
50	1	51	Passion, Roadster	-		0,70	B8ES	2411	05	BR8EIX	5044
50	1	89	Air	-		0,70	B6HS	4510	09	BR6HIX	3419
50	1	881	P, U (air)	-		0,70	B6HS	4510	09	BR6HIX	3419
50	1	CT	S, SS	-		1,00	BP7HS-10	7829	-	-	-
50	1	DX	Boite 5	-		0,70	BR8ES	5422	05	BR8EIX	5044
50	1	DX	S	-		0,70	BR7HS	4122	03	BR7HIX	7067
80	1		Active	-		0,70	BPR7HS	6422	14	BPR7HIX	5944
80	1		Evolis, Business Class	-		0,70	BR8HS	4322	01	BR8HIX	7001
80	1		Zest	-		0,70	BR7HS	4122	03	BR7HIX	7067
100	1		Booster	99-		1,00	BPR7HS-10	1092	-	-	-
100	1		Nitro, Ovetto	00-		1,00	BR8HS-10	1134	-	-	-
125	1		Active	-95		0,70	CR6HSA	2983	-	CR6HIX	7274
125	1		Doodo	00-		0,60	CR8E	1275	04	CR8EIX	4218
125	1		Flame, Flame R	95-99		0,70	CR7E	4578	12	CR7EIX	7385
125	1		Flame R	00-		0,70	CR7E	4578	12	CR7EIX	7385
125	1		Skycruiser	06-		0,90	CPR9EA-9	2308	-	-	-
125	1		Skyliner	98-		0,70	CR8E	1275	04	CR8EIX	4218
125	1		Thunder	01-		0,60	CR8E	1275	04	CR8EIX	4218
125	1		X-Over	10-		0,90	CPR9EA-9	2308	-	-	-
125	1	XC	Flame	-94		0,70	CR6HSA	2983	-	CR6HIX	7274
125	1	XC	Flame	95-		0,70	CR7E	4578	12	CR7EIX	7385
150			Vertex	-		0,70	CR7E	4578	12	CR7EIX	7385
180	1		Skyliner	03-		0,80	CR8E	1275	04	CR8EIX	4218
300	1		Kilibre	03-		0,90	DR8EA	7162	11	DR8EIX	6681
400			Skyliner	04-		0,70	CR7E	4578	12	CR7EIX	7385

MONDIAL

CYL. Nb Cyl. TYPE MODÈLE



INFO



N° STOCK

N° BLISTER



N° STOCK IX

MONDIAL

50	1	Cross Spezial, Mondialino	-	0,50	B7HS	5110	03	BR7HIX	7067
50	1	Radial, Regularita	-	0,50	B8HS	5510	01	BR8HIX	7001
50	1	Spezial V4 Record	-	0,50	B7ES	1111	-	BR7EIX	6664
50	1	Touring	-	0,50	B8HS	5510	01	BR8HIX	7001
50	1	Tourismo	-	0,50	B7HS	5110	03	BR7HIX	7067
125	1	Cross Radial v6	-	0,50	B7HS	5110	03	BR7HIX	7067
175	1	175 SS	-	0,50	B9HS	5810	-	BR9HIX	5687
1000	2	SP Piega VTR	03-	1,10	FR9BI-11	4709	-	-	-





MONTESA

123		COTA	-	0,50	B6ES	7310	-	-	-
125		MH 123 Moteur Honda	-	0,70	BR7ES	5122	-	BR7EIX	6664
175		COTA 172, 200	-	0,50	B6ES	7310	-	-	-
200		MH Moteur Honda	-	0,50	BPR7ES	2023	-	BPR7EIX	4055
250		310	-	0,50	BPR7ES	2023	-	BPR7EIX	4055
250		COTA 242	-	0,50	BP6ES	7811	-	BPR6EIX	6637
250		COTA 247	-	0,60	B6HS	4510	09	BR6HIX	3419
250		COTA 248	-	0,50	BP5ES	6511	-	BPR5EIX	6597
250		COTA 315 Moteur Honda	97-99	0,60	BR6ES	4922	-	-	-
250	1	COTA 4 RT	05-	0,90	CR6EH-9	2688	-	-	-
260		304, 307, 309, 311	-	0,50	BPR5ES	7422	-	BPR5EIX	6597
260		314	-	0,60	BR6ES	4922	-	-	-
309	1	COTA	-	0,60	BPR7ES	2023	-	BPR7EIX	4055
310		348	-	0,50	BPR5ES	7422	-	BPR5EIX	6597
310	1	COTA Evasion	-	0,60	BPR7ES	2023	-	BPR7EIX	4055
315	1	COTA R	97-	0,60	BR6ES	4922	-	-	-
330		330	-	0,50	BPR5ES	7422	-	BPR5EIX	6597
350		335	-	0,50	BPR5ES	7422	-	BPR5EIX	6597
350		Cota 349	-	0,50	BP5ES	6511	-	BPR5EIX	6597

MOTO GUZZI

350	2	Nevada Club	98-99	0,70	BR8ES	5422	05	BR8EIX	5044
350	2	Nevada NT	94-97	0,70	BR8ES	5422	05	BR8EIX	5044
650		V	87-	0,50	BCPR6ES	2330	-	BCPR6EIX	5689
650		V Florida	92-	0,60	B8ES	2411	05	BR8EIX	5044
750	2	Breva	-	0,60	BR8ES	5422	05	BR8EIX	5044
750	2	Nevada Base-Club	02-03	0,60	BR8ES	5422	05	BR8EIX	5044
750	2	Nevada Basic	92-	0,60	B8ES	2411	05	BR8EIX	5044
750	2	Nevada Classic	04-	0,60	BR8ES	5422	05	BR8EIX	5044
750	2	Nevada Club	98-01	0,60	BR8ES	5422	05	BR8EIX	5044
750	2	Nevada NT	94-97	0,70	BR8ES	5422	05	BR8EIX	5044
750	2	Racer, Spécial, V7, V7 Spécial	12-	0,90	CPR8EB-9	6607	-	-	-
750	2	V7 Café Classic, V7 Classic, V7 Racer	09-	0,60	BR8ES	5422	05	BR8EIX	5044
750	2	V Breva i.e	04-	0,60	BPR6ES	7822	-	BPR6EIX	6637
850	2	V Breva	06-	0,60	BPR6ES	7822	-	BPR6EIX	6637
850	2	Griso	06-	0,60	BPR6ES	7822	-	BPR6EIX	6637
850	2	Norge	07-	0,70	BPR6ES	7822	-	BPR6EIX	6637
850	2	T4, T5, TS 5	-	0,60	BP6ES	7811	-	BPR6EIX	6637
936	2	Bellagio	11-	0,60	BPR6ES	7822	-	BPR6EIX	6637
940	2	Bellagio	07-	0,70	BPR6ES	7822	-	BPR6EIX	6637
			2 Bougies par Cylindre	+0,70	+PMR8B	+6378		+PMR8B	+6378
1000	2	California (Carbu & Inj.)	94-97	0,70	BPR6ES	7822	-	BPR6EIX	6637
1000	2	Daytona	92-95	0,70	D9EA	2420	-	DR9EIX	4772
1000	2	Daytona Racing	96	0,70	D9EA	2420	-	DR9EIX	4772
1000	2	Daytona RS	97-98	0,70	DR9EA	3437	-	DR9EIX	4772
1000	2	Quota	92-97	0,60	BP7ES	2412	-	BPR7EIX	4055
1000	2	Quota I.E.	-	0,70	BPR8ES	3923	-	BPR8EIX	6684
1000		Series 1000	-	0,70	BP6ES	7811	-	BPR6EIX	6637
1000	2	Strada	-	0,60	BP6ES	7811	-	BPR6EIX	6637
1000	2	V10 Centauro	97-99	0,70	DR9EA	3437	-	DR9EIX	4772
1000	2	V10 Centauro GT, Centauro Sport	96-	0,70	DR9EA	3437	-	DR9EIX	4772
1100	2	V Breva	05-	0,70	BPR6ES	7822	-	BPR6EIX	6637
			2 Bougies par Cylindre	+0,70	+PMR8B	+6378		+PMR8B	+6378
1100	2	California Aluminium	03-04	0,70	BPR6ES	7822	-	BPR6EIX	6637
1100	2	California Carb, Inj /Special	94-97	0,60	BPR6ES	7822	-	BPR6EIX	6637
1100	2	California Classic	06-	0,60	BPR6ES	7822	-	BPR6EIX	6637
			2 Bougies par Cylindre	+0,70	+PMR8B	+6378		+PMR8B	+6378
1100	2	California EV	97-05	0,70	BPR6ES	7822	-	BPR6EIX	6637
1100	2	California EV Touring	01-02	0,70	BPR6ES	7822	-	BPR6EIX	6637

MOTO GUZZI

CYL.	Nb Cyl.	TYPE	MODÈLE		INFO			N° STOCK	N° BLISTER		N° STOCK IX
1100	2		California Jackal	99-01		0,70	BPR6ES	7822	-	BPR6EIX	6637
1100	2		California Special	99-00		0,70	BPR6ES	7822	-	BPR6EIX	6637
1100	2		California Special Sport, California Stone Metal	01-02		0,70	BPR6ES	7822	-	BPR6EIX	6637
1100	2		California Stone Touring, California Titanium	03-04		0,70	BPR6ES	7822	-	BPR6EIX	6637
1100	2		California Touring/Vintage	06	2 Bougies par Cylindre	0,60	BPR6ES	7822	-	BPR6EIX	6637
						+0,70	+PMR8B	+6378		+PMR8B	+6378
1100	2		California Vintage 90ième Anniversaire	11-	2 Bougies par Cylindre	0,70	BPR6ES	7822	-	BPR6EIX	6637
						+0,70	+PMR8B	+6378		+PMR8B	+6378
1100	2		Griso	05-	2 Bougies par Cylindre	0,70	BPR6ES	7822	-	BPR6EIX	6637
						+0,70	+PMR8B	+6378		+PMR8B	+6378
1100	2		Quota I.E. / ES	98-02		0,60	BPR6ES	7822	-	BPR6EIX	6637
1100	2		Sport	94-99		0,70	BPR6ES	7822	-	BPR6EIX	6637
1100	2	V11	Ballabio, Cafe Sport	03-05		0,70	BPR6ES	7822	-	BPR6EIX	6637
1100	2	V11	Coppa Italia	03-04		0,70	BPR6ES	7822	-	BPR6EIX	6637
1100	2	V11	Le Mans	01-04		0,70	BPR6ES	7822	-	BPR6EIX	6637
1100	2	V11	Le Mans Nero / Rosso	04-		0,60	BPR6ES	7822	-	BPR6EIX	6637
1100	2	V11	Naked, Sucre	03-		0,60	BPR6ES	7822	-	BPR6EIX	6637
1100	2	V11	Scura R	04-05		0,70	BPR6ES	7822	-	BPR6EIX	6637
1100	2	V11	Sport	99-04		0,70	BPR6ES	7822	-	BPR6EIX	6637
1100	2	V11	Sport Ballado	03-		0,60	BPR6ES	7822	-	BPR6EIX	6637
1100	2	V11	Sport IE, Sport IE Corsa	95-99		0,60	BPR6ES	7822	-	BPR6EIX	6637
1100	2	V11		05-	2 Bougies par Cylindre	0,70	BPR6ES	7822	-	BPR6EIX	6637
						+0,70	+PMR8B	+6378		+PMR8B	+6378
1150	2		Breva V1200	08-	2 Bougies par Cylindre	0,70	BPR6ES	7822	-	BPR6EIX	6637
						+0,70	+PMR8B	+6378		+PMR8B	+6378
1151			Griso 8V Special Edition, Norge GT 8V	09-		0,70	CR8EKB	4374	-	CR8EIX	4218
1150	2		Stelvio 1200 4V	08-		0,70	PMR8B	6378	-	-	-
1151			Stelvio 1200 NTX	09-		0,70	CR8EKB	4374	-	CR8EIX	4218
1200	2		Griso 8V	08-		0,70	PMR8B	6378	-	-	-
1200	2		Norge	06-	2 Bougies par Cylindre	0,70	BPR6ES	7822	-	BPR6EIX	6637
						+0,70	+PMR8B	+6378		+PMR8B	+6378
1200	2		Sport 4V	09-		0,70	CR8EKB	4374	-	CR8EIX	4218
1200	2		Stelvio / NTX	11-		0,70	CR8EKB	4374	-	CR8EIX	4218
1225	2	MGS	Café Sport	04-		0,70	D10EA	2720	-	-	-
1225	2	MGS-01	Corsa	04-		0,60	-	-	-	DCPR9EIX	2316

MOTO HISPANA

50	1		Furia, Furia Cross - 12,7mm	99-		0,60	BPR7HS	6422	14	BPR7HIX	5944
50	1		Furia, Furia Cross - 19mm	99-		0,60	BR9ES	5722	02	BR9EIX	3981
50	1	RX		-		0,60	BR9ES	5722	02	BR9EIX	3981
50	1	RYZ	Cross, Supermoto	-		0,60	BR9ES	5722	02	BR9EIX	3981
125		RYZ		-		0,60	CR7HSA	4549	07	CR7HIX	7544

MOTO MORINI

1187	2		9 1/2, Corsaro	06-		0,70	CR9E	6263	06	CR9EIX	3521
------	---	--	----------------	-----	--	------	------	------	----	--------	------

MOTOBECANE

50	1		Tous modèles	-		0,60	B6HS	4510	09	BR6HIX	3419
----	---	--	--------------	---	--	------	------	------	----	--------	------

MOTORTEK - Quad

125	1	MT	4x2	00-		0,70	C7HSA	4629	07	CR7HIX	7544
175	1	MT	R 4x2	00-		0,70	DR8EA	7162	11	DR8EIX	6681

MSA

50	1	MX		-		0,70	BR8HSA	5539	-	BR8HIX	7001
50	1	RC	/SM	99-		0,70	BR8ES	5422	05	BR8EIX	5044
50	1	RC	Trophy "YACCO"	00-		0,70	BR8ES	5422	05	BR8EIX	5044
50	1	RSE		99-		0,70	BR8ES	5422	05	BR8EIX	5044
50	1	RTW		00-		0,70	BR8ES	5422	05	BR8EIX	5044
50	1	SM	Super Motard	01-		0,70	BR8ES	5422	05	BR8EIX	5044

MSA - Quad

50	1		Fox	00-		0,70	BR8HSA	5539	-	BR8HIX	7001
50	1		Mini Fox	00-		0,70	BM6A	5921	-	-	-
50	1	VR	Sport	00-		0,70	BR8HSA	5539	-	BR8HIX	7001
90	1		Fox	00-		0,70	CR7HSA	4549	07	CR7HIX	7544
100	1		Fox	00-		0,70	BR8HSA	5539	-	BR8HIX	7001
100	1	VR	Sport	00-		0,70	BR8HSA	5539	-	BR8HIX	7001

MV AGUSTA

CYL. Nb Cyl. TYPE MODÈLE



INFO



N° STOCK

N° BLISTER



N° STOCK IX

MV AGUSTA

675	3	F3	Brutale	13-	0,70	CR9EKB	2305	-	CR9EIX	3521
750	4	F4	Brutale S	02-	0,70	CR9EB	6955	06	CR9EIX	3521
750	4	F4	Brutale S	02-06	0,70	CR9EKB	2305	-	CR9EIX	3521
750	4	F4	Brutale oro 93kW	99-	0,70	CR9EKB	2305	-	CR9EIX	3521
750	4	F4	Oro / S	99-	0,70	CR9EB	6955	06	CR9EIX	3521
750	4	F4	Oro -> Fgst.300	99-	0,70	CR9EKB	2305	-	CR9EIX	3521
750	4	F4	S American	-	0,50	B7ES	1111	-	BR7EIX	6664
750	4	F4	S 1+1 (biposto)	00-	0,70	CR9EB	6955	06	CR9EIX	3521
750	4	F4	SS PR / Senna / 103KW	99-	0,70	CR9EKB	2305	-	CR9EIX	3521
800	3		Rivale	13-	0,90	CR9EIB-9	92579	-	-	-
910	4	F4	Brutale 910 / R	05-	0,70	CR9EB	6955	06	CR9EIX	3521
990	4		Brutale R	10-	0,70	CR9EB	6955	06	CR9EIX	3521
1000	4	F4	1000 S/ Senna	06-	1,10	R0045J-10	7400	-	-	-
1000	4	F4	1000 Tamburini	04-	1,10	R0045J-10	7400	-	-	-
1078	4	F4	Brutale 1078 RR, RR 312	08-	0,70	CR9EB	6955	06	CR9EIX	3521

MZ

50	1		Moskito FB	97-	0,60	BR7HS	4122	03	BR7HIX	7067
50	1		Moskito RX	02-	0,60	BR8HSA	5539	-	BR8HIX	7001
125	1		RT	00-	0,70	CR8E	1275	04	CR8EIX	4218
125	1		Saxon Roadster	94-	0,60	B8HS	5510	01	BR8HIX	7001
125	1		SM	01-	0,70	CR8E	1275	04	CR8EIX	4218
125	1		Sportstar	93-	0,60	B8HS	5510	01	BR8HIX	7001
125	1		SX	02-	0,70	CR8E	1275	04	CR8EIX	4218
150	1		Roadster	-	0,60	B8HS	5510	01	BR8HIX	7001
250	1		Tour	94-	0,60	B8HS	5510	01	BR8HIX	7001
500	1		Country, Silverstar/Classic/Voyager	94-	0,70	D8EA	2120	11	DR8EIX	6681
500	1		Tour	95-	0,70	D8EA	2120	11	DR8EIX	6681
660	1		Baghira Enduro & Forest	98-	0,90	DPR8EA-9	4929	08	DPR8EIX-9	2202
660	1		Baghira HR SM Street Moto	04-	0,90	DPR9EA-9	5329	-	DPR9EIX-9	5545
660	1		Mastiff	98-	0,90	DPR8EA-9	4929	08	DPR8EIX-9	2202
660	1		Skorpion Sport/Tour/Traveller	94-	0,90	DPR8EA-9	4929	08	DPR8EIX-9	2202
1000	2		S / SF / ST	04-	0,80	BCPR6ET	2197	-	BCPR6EIX	5689

MZ-Quad





50	1		ATV 50	03-	0,60	BP6HS	4511	-	BPR6HIX	4085
100	1		ATV 100	03-	0,60	BP6HS	4511	-	BPR6HIX	4085
125	1		MT 125 Cobra	05-	0,60	C7HSA	4629	07	CR7HIX	7544
150	1		KX 150, VRS 150	05-	0,60	CR7E	4578	12	CR7EIX	7385





MZ KANUNI

125		SM	Classic	97-	0,50	B8HS	5510	01	BR8HIX	7001
300			Kanuni	97-	0,50	B8HS	5510	01	BR8HIX	7001

PEUGEOT MOTORCYCLES

50	1		101, 102, 103, 104, 105	-	0,50	B6HS	4510	09	BR6HIX	3419
50	1		Buxy	95-97	0,60	BR7HS	4122	03	BR7HIX	7067
50	1		Blaster RS12	06-	0,60	BR7HS	4122	03	BR7HIX	7067
50	1		Elystar Advantage	-	0,70	BR7HS	4122	03	BR7HIX	7067
50	1		Elystar TSDI	-05	0,60	CPR8E	7411	-	-	-
50	1		Elystar TSDI	06-	0,60	CR7EKA	1462	-	-	-
50	1		Elyséo	99-	0,60	BR7HS	4122	03	BR7HIX	7067
50	1		Fox Concept	-	0,70	BR7HS	4122	03	BR7HIX	7067
50	1		Fox L / LM / SPX M	-	0,70	B7HS	5110	03	BR7HIX	7067
50	1		Fox M / MPH / M Pro / LM Pro	-	0,70	BR7HS	4122	03	BR7HIX	7067
50	1		Jet C-Tech Carbu	10-	0,60	CR7EB	4663	12	CR7EIX	7385
50	1		Jet Force	-05	0,60	CPR8E	7411	-	-	-
50	1		Jet Force - 14x12,7mm	-	0,70	BR7HS	4122	03	BR7HIX	7067
50	1		Jet Force C-Tech	05-	0,60	CR7EB	4663	12	CR7EIX	7385
50	1		Jet Force H2i	11-	0,70	CR7EKA	1462	-	-	-
50	1		Jet Force TSDI	03-	0,60	CR7EKA	1462	-	-	-
50	1		Kisbee Carbu	10-	0,70	CR7HSA	4549	07	CR7HIX	7544
50	1		Looxor	01-02	0,60	BR7HS	4122	03	BR7HIX	7067
50	1		Looxor TSDI Injection 2 Tps	02-06	0,60	CR7EKA	1462	-	-	-
50	1		Ludix 2-50	04-	0,60	BR7HS	4122	03	BR7HIX	7067
50	1		Ludix 14 EP, Ludix 14 Pro	04-	0,60	BR7HS	4122	03	BR7HIX	7067
50	1		Ludix Blaster	04-	0,70	BR7HS	4122	03	BR7HIX	7067





CYL.	Nb Cyl.	TYPE	MODÈLE		INFO			N° STOCK	N° BLISTER		N° STOCK IX
50	1		Ludix Blaster Furious	11-		0,80	CR7EKB	4455	-	CR7EIX	7385
50	1		Ludix Blaster ref. liquide	07-		0,70	CR7E	4578	12	CR7EIX	7385
50	1		Ludix Blaster RS12 LC-12	04-		0,60	BR7HS	4122	03	BR7HIX	7067
50	1		Ludix Classic / Elegance / One	04-		0,70	BR7HS	4122	03	BR7HIX	7067
50	1		Ludix Snake / Trend	04-		0,70	BR7HS	4122	03	BR7HIX	7067
50	1		Ludix Urban Track	04-		0,60	BR7HS	4122	03	BR7HIX	7067
50			Metal-X	02-		0,60	BR7HS	4122	03	BR7HIX	7067
50	1		NK7	10-		0,60	BR9ES	5722	02	BR9EIX	3981
50	1		Rapido	-		0,60	BP6HS	4511	-	BPR6HIX	4085
50	1		Rapido 2, Rapido 3 50	-		0,60	BR6HSA	4296	-	BR6HIX	3419
50	1		Speedake	-		0,70	BR7HS	4122	03	BR7HIX	7067
50	1		Speedfight	-		0,60	BR8HS	4322	01	BR8HIX	7001
50	1		Speedfight AC	98-		0,70	BR7HS	4122	03	BR7HIX	7067
50	1		Speedfight LC/LCD/LCDP/LCT/M/MP/Prost	96-00		0,60	BR7HS	4122	03	BR7HIX	7067
50	1		Speedfight X' Team	99-00		0,60	BR7HS	4122	03	BR7HIX	7067
50	1		Speedfight 2 AC	00-		0,60	BR7HS	4122	03	BR7HIX	7067
50	1		Speedfight 2 AC Iron / AC Motorsport	-		0,70	BR7HS	4122	03	BR7HIX	7067
50	1		Speedfight 2 LC	00-		0,60	BR7HS	4122	03	BR7HIX	7067
50	1		Speedfight 2 LC Motorsport / LC Victories	-		0,70	BR7HS	4122	03	BR7HIX	7067
50	1		Speedfight 2 WRC / 2 X-Race	00-		0,60	BR7HS	4122	03	BR7HIX	7067
50	1		Speedfight 3 2T	12-		0,70	BR7HS	4122	03	BR7HIX	7067
50	1		Speedfight 3 4T	12-		0,70	CR7EKA	1462	-	-	-
50	1		Speedfight 3 AC 25kmh	09-		0,70	BPR5HS	6222	-	-	-
50	1		Speedfight 3 LC 45kmh	09-		0,60	CR7EB	4663	12	CR7EIX	7385
50	1		Speedfight 3 2T/RS ref.air 45kmh	09-		0,60	BR7HS	4122	03	BR7HIX	7067
50	1		Speedfight 3 Le Mans / 3 Team Peugeot	11-		0,70	BR7HS	4122	03	BR7HIX	7067
50	1		Squab	-		0,70	BR7HS	4122	03	BR7HIX	7067
50	1		TKR 50	03-		0,60	BR7HS	4122	03	BR7HIX	7067
50	1		TKR 50 307 WRC	05-		0,60	BR7HS	4122	03	BR7HIX	7067
50	1		TKR Furious AC / Streetboard / Victories	-		0,60	BR7HS	4122	03	BR7HIX	7067
50	1		Trekker	-		0,60	BR8HS	4322	01	BR8HIX	7001
50	1		Trekker Black 2	00-		0,70	BR7HS	4122	03	BR7HIX	7067
50	1		Trekker Off Road	97-		0,70	BR7HS	4122	03	BR7HIX	7067
50	1		Trekker Métal-X, Trekker Tuning	00-		0,70	BR7HS	4122	03	BR7HIX	7067
50	1		Trekker Road	97-		0,70	BR7HS	4122	03	BR7HIX	7067
50	1		Trekker Streetboard, Trekker Urban Black	99-		0,70	BR7HS	4122	03	BR7HIX	7067
50	1		Tweet 4T	10-		0,70	CR6HSA	2983	-	CR6HIX	7274
50	1		V-Clic / Silversport	07-		0,60	CR7HSA	4549	07	CR7HIX	7544
50	1		Vivacity	99-		0,60	BR7HS	4122	03	BR7HIX	7067
50	1		Vivacity Compact, Vivacity Silversport	99-		0,70	BR7HS	4122	03	BR7HIX	7067
50	1		Vivacity Sportline	99-		0,60	BR7HS	4122	03	BR7HIX	7067
50	1		Vivacity 2T	10-		0,70	BR7HS	4122	03	BR7HIX	7067
50			Vivacity 3 Sixties	11-		0,70	CR6HSA	2983	-	CR6HIX	7274
50	1		Vivacity 4T	10-		0,70	CR7EKA	1462	-	-	-
50	1		VS-R, X-Race	00-		0,60	BR7HS	4122	03	BR7HIX	7067
50			XPS 50 Enduro, Trail, Supermotard 50	03-		0,70	BR9ES	5722	02	BR9EIX	3981
50	1		Zenith, N, LN, LS	99-		0,70	BR7HS	4122	03	BR7HIX	7067
50	1		Zenith LM2	96-		0,50	BR8HS	4322	01	BR8HIX	7001
50	1	103	MVL M	-		0,70	BP5HS	4111	-	-	-
50	1	103	RCX M, LC M	-		0,60	BR7HS	4122	03	BR7HIX	7067
50	1	103	SPX	02-		0,70	BR7HS	4122	03	BR7HIX	7067
50	1	103	Vogue LE, SE, VSE	-		0,70	BP5HS	4111	-	-	-
50	1	RC	X' Race	00-		0,70	BR7HS	4122	03	BR7HIX	7067
50	1	SC	L	-		0,50	B6HS	4510	09	BR6HIX	3419
50	1	ST	L2, L3	-		0,60	BR6HSA	4296	-	BR6HIX	3419
50	1	SV		95-		0,60	B8HS	5510	01	BR8HIX	7001
50	1	SV		96-		0,60	BR8HS	4322	01	BR8HIX	7001
50	1	SV	Geo, Junior, M	-		0,60	B8HS	5510	01	BR8HIX	7001
50	1	SX	Pro	-		0,50	BPR6HS	7022	-	BPR6HIX	4085
50	1	XP6	Trail, Supermotard	98-		0,60	BR9ES	5722	02	BR9EIX	3981
50	1	XR6	Multivitesses	01-		0,60	BR9ES	5722	02	BR9EIX	3981
50	1	XR7		10-		0,60	BR9ES	5722	02	BR9EIX	3981
80	1	SV		-		0,60	B8HS	5510	01	BR8HIX	7001
80	1	SX	PRO	-		0,50	BPR6HS	7022	-	BPR6HIX	4085
100	1		Elyséo	99-		0,70	BR8ES	5422	05	BR8EIX	5044
100			Metal X	02-		0,60	BR8ES	5422	05	BR8EIX	5044
100	1		Speedfight & Prost GP	97-99		0,70	BR8ES	5422	05	BR8EIX	5044
100			Speedfight WRC 206 (Refr. Air)	01-		0,60	BR8ES	5422	05	BR8EIX	5044
100	1		Speedfight 2	00-		0,70	BR8ES	5422	05	BR8EIX	5044
100	1		Speedfight 2 Victories	06-		0,60	BR8ES	5422	05	BR8EIX	5044
100	1		TKR 100	00-		0,60	BR8ES	5422	05	BR8EIX	5044
100	1		Trekker	97-		0,70	BR8ES	5422	05	BR8EIX	5044
100	1	M	Looxor	01-		0,70	BR8ES	5422	05	BR8EIX	5044
100	1	M	VivaCity	99-		0,70	BR8ES	5422	05	BR8EIX	5044
100	1	SV		97-		0,70	BR8ES	5422	05	BR8EIX	5044

CYL.	Nb Cyl.	TYPE	MODÈLE		INFO			N° STOCK	N° BLISTER		N° STOCK IX
100	1	SV	L	-		0,70	BR8ES	5422	05	BR8EIX	5044
125	1		Atlantis	06-		0,70	CR9EB	6955	06	CR9EIX	3521
125	1		Black Sat Compresseur	08-		0,70	CR9EB	6955	06	CR9EIX	3521
125	1		Citystar	11-		0,70	CR8EB	7784	04	CR8EIX	4218
125	1		Elyséo	99-		0,70	CR7E	4578	12	CR7EIX	7385
125	1		Elyseo Advantage	04-		0,70	CR7E	4578	12	CR7EIX	7385
125	1		Elystar	02-		0,70	CR7EB	4663	12	CR7EIX	7385
125	1		Elystar Advantage	04-		0,70	CR7EB	4663	12	CR7EIX	7385
125	1		Géopolis	06-		0,70	CR9EB	6955	06	CR9EIX	3521
125	1		Géopolis RS	08-		0,70	CR8EB	7784	04	CR8EIX	4218
125	1		Jet Force	03-		0,70	CR7EB	4663	12	CR7EIX	7385
125	1		Jet Force Compressor	05-		0,70	CR8EK	3478	-	CR8EIX	4218
125	1		Jet Force Compressor K	05-		0,70	CR8EKB	4374	-	CR8EIX	4218
125	1		Liberty	03-		0,70	CR7EB	4663	12	CR7EIX	7385
125	1		Ludix 125	04-		0,60	CR9EB	6955	06	CR9EIX	3521
125	1		LXR	09-		0,70	CR7E	4578	12	CR7EIX	7385
125	1		Satelis	05-08		0,70	CR9EB	6955	06	CR9EIX	3521
125	1		Satelis, Satelis Compressor	12-		0,70	CR8EB	7784	04	CR8EIX	4218
125	1		Satelis Blacksat	12-		0,70	CR9EB	6955	06	CR9EIX	3521
125	1		Satelis Compressor, Satelis Executive	06-		0,60	CR9EB	6955	06	CR9EIX	3521
125	1		Satelis GT Sport, Satelis Roland Garros	12-		0,70	CR8EB	7784	04	CR8EIX	4218
125	1		Satelis RS	08-		0,70	CR8EB	7784	04	CR8EIX	4218
125	1		Satelis Withesat	12-		0,70	CR8EB	7784	04	CR8EIX	4218
125	1		Sum-Up	07-		0,70	CR7HSA	4549	07	CR7HIX	7544
125	1		Tweet	10-		0,70	CR7HSA	4549	07	CR7HIX	7544
125	1		Tweet RS	12-		0,80	CR7HSA	4549	07	CR7HIX	7544
125	1		Vivacity	10-		0,70	CR7HSA	4549	07	CR7HIX	7544
125	1		Vivacity Roland-Garros, Satelis Roland Garros	12-		0,80	CR7HSA	4549	07	CR7HIX	7544
125	1		WTR	07-		0,70	CR9EB	6955	06	CR9EIX	3521
125		XPS	CT	06-08		0,70	CR7HSA	4549	07	CR7HIX	7544
125	1	F	Looxor	02-		0,70	CR7EB	4663	12	CR7EIX	7385
150	1		Elyséo	01-		0,70	CR7E	4578	12	CR7EIX	7385
150	1		Elystar, Looxor	03-		0,70	CR7EB	4663	12	CR7EIX	7385
150	1		Tweet	10-		0,70	CR7HSA	4549	07	CR7HIX	7544
200	1		LXR	09-		0,70	CR7E	4578	12	CR7EIX	7385
250	1		Elystar Injection	06-		0,70	PMR8B	6378	-	-	-
250	1		Geo RS 250, Géopolis	08-		0,70	PMR8B	6378	-	-	-
250			Geopolis Executive	07-		0,60	CR9EB	6955	06	CR9EIX	3521
250	1		Satelis	06-		0,70	PMR8B	6378	-	-	-
250	1		Satelis RS	08-		0,70	PMR8B	6378	-	-	-
250	1	SV		01-		0,90	DPR7EA-9	5129	13	DPR7EIX-9	7803
300	1		Geopolis	10-		0,80	CR7EKB	4455	-	CR7EIX	7385
300	1		Géopolis RS	12-		0,80	CR7EKB	4455	-	CR7EIX	7385
400	1		Géopolis	07-		0,80	CR7EKB	4455	-	CR7EIX	7385
400	1		Géopolis RS	07-		0,70	CR7EKB	4455	-	CR7EIX	7385
400	1		Metropolis 400i, Metropolis 400i RS	13-		0,90	CPR8EB-9	6607	-	-	-
400	1		Satelis, Satelis RS	07-		0,70	CR7EKB	4455	-	CR7EIX	7385
400	1		Satelis Premium RS	11-		0,80	CR7EKB	4455	-	CR7EIX	7385
500	1		Géopolis, Satelis	07-		0,70	CR7EKB	4455	-	CR7EIX	7385
500	1		Satelis RS	12-		0,80	CR7EKB	4455	-	CR7EIX	7385



P.G.O.

50	1		Big Max, Sport / LTD / R	95-		0,70	BP7HS	5111	14	BPR7HIX	5944
50	1		Comet, Light, Sport, Larrousse F1	93-		0,70	BP7HS	5111	14	BPR7HIX	5944
50			Comet, PMX Sport, Rodoshow, T-Rex	98-		0,60	BPR7HS	6422	14	BPR7HIX	5944
50	1		Galaxy, Galaxy Junior	93-		0,70	BP7HS	5111	14	BPR7HIX	5944
50	1		G-Max	04-		0,60	BPR7HS	6422	14	BPR7HIX	5944
50			Libra, Ligero	08-		0,60	BPR7HS	6422	14	BPR7HIX	5944
50	1		Mega 50	96-		0,50	BPR7HS	6422	14	BPR7HIX	5944
50	1		New Galaxy 50	-		0,60	BP6HS	4511	-	BPR6HIX	4085
50	1		PMS	99-		0,70	BP7HS	5111	14	BPR7HIX	5944
50	1		PMX	97-		0,70	BP7HS	5111	14	BPR7HIX	5944
50	1		Road 66	94-		0,70	BP7HS	5111	14	BPR7HIX	5944
50	1		Rodoshow	00-		0,70	BP7HS	5111	14	BPR7HIX	5944
50	1		Star	92-		0,70	BP6HS	4511	-	BPR6HIX	4085
50	1		Star 2	94-		0,70	BP7HS	5111	14	BPR7HIX	5944
50	1		Super Comet 50	-		0,70	BP7HS	5111	14	BPR7HIX	5944
50	1		Tornado	97-00		0,50	BPR7HS	6422	14	BPR7HIX	5944
50	1		TR3, TR3-50	-		0,70	BP7HS	5111	14	BPR7HIX	5944
50	1		T-Rex 50	99-		0,70	BP7HS	5111	14	BPR7HIX	5944
80	1		Big Max 1.25	96-		0,50	BPR7HS	6422	14	BPR7HIX	5944
80	1		Star	92-		0,70	BP6HS	4511	-	BPR6HIX	4085
90	1		Big Max 90	96-		0,50	BPR7HS	6422	14	BPR7HIX	5944

CYL.	Nb Cyl.	TYPE	MODÈLE		INFO			N° STOCK	N° BLISTER		N° STOCK IX
90	1	Galaxy		-		0,60	BPR7HS	6422	14	BPR7HIX	5944
125	1	G-Max		05-		0,70	C7HSA	4629	07	CR7HIX	7544
125		Libra 125, Ligerio 125		08-		0,60	C7HSA	4629	07	CR7HIX	7544
125	1	Tornado		-		0,70	BPR7HS	6422	14	BPR7HIX	5944
125	1	T-Rex 125 2 Temps		98-		0,60	BP7HS	5111	14	BPR7HIX	5944
125	1	T-Rex 125 4 Temps		98-		0,70	CR7HSA	4549	07	CR7HIX	7544
150	1	T-Rex 150 4 Temps		03-		0,70	CR7HSA	4549	07	CR7HIX	7544
250		G-Max 250		05-07		0,70	DPR7EA-9	5129	13	DPR7EIX-9	7803







P.G.O. - Quad





110	1			03-		0,70	BPR7HS	6422	14	BPR7HIX	5944
151	1			03-		0,70	CR7HSA	4549	07	CR7HIX	7544







PIAGGIO

25	1	Free 25 Mofa		-		0,50	BP8ES	2912	-	BPR8EIX	6684
25	1	Zip 25 Mofa, Zip Base 25 / Mofa		-		0,50	BPR8ES	3923	-	BPR8EIX	6684
50	1	50 R, Special, 50 S, Ape 50, Boss		-		0,50	B6HS	4510	09	BR6HIX	3419
50	1	Bravo - Si / Moped		-		0,50	B5HS	4210	-	-	-
50	1	Bravo P, Bravo PV		-		0,70	BR6HS	3922	09	BR6HIX	3419
50	1	Bravo PVRI		-		0,50	B8HS	5510	01	BR8HIX	7001
50	1	Ciao - Bravo SI / Mofa		-		0,50	B5HS	4210	-	-	-
50	1	Ciao M Kat, Ciao V Kat		-		0,70	BR6HS	3922	09	BR6HIX	3419
50	1	Diesis 50		-		0,70	BR9ES	5722	02	BR9EIX	3981
50	1	Eaglet, ET2 - Carbu		-		0,50	B9ES	2611	02	BR9EIX	3981
50	1	ET2i		98-		0,60	-	-	-	DCPR9EIX	2316
50	1	ET4		-		0,70	CR9EB	6955	06	CR9EIX	3521
50	1	Fly 2 Temps		-		0,60	BR9ES	5722	02	BR9EIX	3981
50	1	Fly 4 Temps		06-		0,70	PMR7A	4259	-	-	-
50	1	Grillo / Mofa		-		0,50	B5HS	4210	-	-	-
50	1	LX 2 Temps		-		0,60	BR9ES	5722	02	BR9EIX	3981
50	1	LX 4 Temps		06-		0,80	CR8EB	7784	04	CR8EIX	4218
50	1	Free		93-		0,50	B9ES	2611	02	BR9EIX	3981
50	1	Liberty 2 Temps		97-		0,70	BR9ES	5722	02	BR9EIX	3981
50	1	Liberty 4 Temps		02-05		0,70	CR9EB	6955	06	CR9EIX	3521
50	1	Liberty 4 Temps		06-		0,70	PMR7A	4259	-	-	-
50	1	Liberty Kat		-		0,70	BR9ES	5722	02	BR9EIX	3981
50	1	Plurimatic		-		0,50	B6HS	4510	09	BR6HIX	3419
50	1	Quartz		92-		0,50	B9ES	2611	02	BR9EIX	3981
50	1	Rush		-		0,60	BR7HS	4122	03	BR7HIX	7067
50	1	Sfera, Sfera 50 Automatique		91-		0,50	B9ES	2611	02	BR9EIX	3981
50	1	Sfera 50 FL, RL, RST, Skipper		-		0,50	B9ES	2611	02	BR9EIX	3981
50	1	Storm Autom.		94-		0,50	B9ES	2611	02	BR9EIX	3981
50	1	Super Bravo / Mofa		-		0,50	B5HS	4210	-	-	-
50	1	Super Bravo 2 Gang / Mofa		-		0,50	B5HS	4210	-	-	-
50	1	TPH		93-		0,50	B9ES	2611	02	BR9EIX	3981
50	1	Typhoon		11-		0,70	CR7EB	4663	12	CR7EIX	7385
50	1	Typhoon air / X 50		96-		0,70	BR9ES	5722	02	BR9EIX	3981
50	1	Typhoon X, Typhoon XR		93-		0,50	B9ES	2611	02	BR9EIX	3981
50	1	Velofax		95-		0,50	B8ES	2411	05	BR8EIX	5044
50	1	Velofax / Mofa		-		0,60	BP8ES	2912	-	BPR8EIX	6684
50	1	Velofax AE		95-		0,50	B8ES	2411	05	BR8EIX	5044
50	1	Velofax L, Velofax M, Velofax S		-		0,50	B9ES	2611	02	BR9EIX	3981
50	1	Vespa 4 vit.		-		0,50	B8HS	5510	01	BR8HIX	7001
50	1	Vespa A		-		0,50	B7ES	1111	-	BR7EIX	6664
50	1	Vespa Delta / Puch Condor		-		0,50	B7HS	5110	03	BR7HIX	7067
50	1	Vespa Elestart		-		0,50	B6HS	4510	09	BR6HIX	3419
50	1	Vespa ET 3 Primavera		-		0,60	BR7HS	4122	03	BR7HIX	7067
50	1	Vespa ET 4		02-05		0,80	CR9EB	6955	06	CR9EIX	3521
50	1	Vespa ET 4		06-		0,70	PMR7A	4259	-	-	-
50	1	Vespa HP 4M		-		0,50	B6HS	4510	09	BR6HIX	3419
50	1	Vespa HP 4M		93-		0,50	B7HS	5110	03	BR7HIX	7067
50	1	Vespa LX 2T		06-		0,60	BR9ES	5722	02	BR9EIX	3981
50	1	Vespa LX 50 4T 4V		10-		0,60	ER9EH-6N	1673	-	ER9EHIX	96652
50	1	Vespa LXV 50		-		0,60	BR9ES	5722	02	BR9EIX	3981
50	1	Vespa R/S		-		0,50	B6HS	4510	09	BR6HIX	3419
50	1	Vespa S		08-		0,60	BR9ES	5722	02	BR9EIX	3981
50	1	Vespa S 50 4T		09-		0,60	ER9EH-6N	1673	-	ER9EHIX	96652
50	1	Vespa Special		-		0,50	B6HS	4510	09	BR6HIX	3419
50	1	Vespa Vale Spécial, Standard		-		0,50	B5HS	4210	-	-	-
50	1	Vespino AL/ALX/GL/GN/GS/NL		-		0,50	B7HS	5110	03	BR7HIX	7067
50	1	Vespino NX/SC/T/TL/TN/TS/TX/XE		-		0,50	B7HS	5110	03	BR7HIX	7067
50	1	NRG		-		0,50	B9ES	2611	02	BR9EIX	3981

CYL.	Nb Cyl.	TYPE	MODÈLE		INFO			N° STOCK	N° BLISTER		N° STOCK IX
50	1	NRG	MC2	-00		0,50	B9ES	2611	02	BR9EIX	3981
50	1	NRG	MC2 50	96-		0,60	B9EG	3530	-	-	-
50	1	NRG	MC2 DD, MC2 DT	-		0,50	B9ES	2611	02	BR9EIX	3981
50	1	NRG	MC3	01-		0,50	B9ES	2611	02	BR9EIX	3981
50	1	NRG	MC3	02-05		0,60	CPR8E	7411	-	-	-
50	1	NRG	MC3	06-		0,60	ZMR7AP	6914	-	-	-
50	1	NRG	MC3 Pure Jet	02-		0,60	CPR8E	7411	-	-	-
50	1	NRG	Extreme, Extreme Kat, H2O Kat	-		0,50	B9ES	2611	02	BR9EIX	3981
50	1	NRG	Power 50 DD	-		-	BR9ES	5722	02	BR9EIX	3981
50	1	NRG	Power DT Purejet	05-		0,60	CPR8E	7411	-	-	-
50	1	NSP	4 Temps Aria	02-		0,80	CR9EB	6955	06	CR9EIX	3521
50	1	NTT		95-		0,50	B9ES	2611	02	BR9EIX	3981
50	1	PK	S Auto	-		0,50	B6ES	7310	-	-	-
50	1	PK	S Auto	-		0,50	BR7ES	5122	-	BR7EIX	6664
50	1	PK	SS, XL2	-		0,50	B7HS	5110	03	BR7HIX	7067
50	1	PK	XL2 Auto	-		0,50	B8ES	2411	05	BR8EIX	5044
50	1	PX		-		0,50	B6HS	4510	09	BR6HIX	3419
50	1	ZIP		92-		0,60	B9ES	2611	02	BR9EIX	3981
50	1	ZIP	4 4 Temps	-		0,60	CR7E	4578	12	CR7EIX	7385
50	1	ZIP	4 Temps	06-		0,70	PMR7A	4259	-	-	-
50	1	ZIP	4 Temps Aria	02-		0,70	CR9EB	6955	06	CR9EIX	3521
50	1	ZIP	& Zip 50	94-		0,60	B9ES	2611	02	BR9EIX	3981
50	1	ZIP	& Zip (Hybrid)	94-		0,50	B9ES	2611	02	BR9EIX	3981
50	1	ZIP	Air	96-		0,70	BR9ES	5722	02	BR9EIX	3981
50	1	ZIP	Base 50	-		0,50	B9ES	2611	02	BR9EIX	3981
50	1	ZIP	Eau	96-		0,70	B10ES	7928	-	BR10EIX	6801
50	1	ZIP	Fast Rider	92-99		0,50	B9ES	2611	02	BR9EIX	3981
50	1	ZIP	Kat	-		0,50	BPR8ES	3923	-	BPR8EIX	6684
50	1	ZIP	RST / F. R. RST	-99		0,50	B9ES	2611	02	BR9EIX	3981
50	1	ZIP	SP	-		0,60	BR9ES	5722	02	BR9EIX	3981
50	1	ZIP	SP	-		0,50	B9EG	3530	-	-	-
50	1	ZIP	SP	96-		0,60	B9ES	2611	02	BR9EIX	3981
75	1	PK	Vespa S Primavera, T3 Prima.	-		0,50	B7HS	5110	03	BR7HIX	7067
75	1	PK	Vespa S/ Elestart/ Junior	-		0,50	B7HS	5110	03	BR7HIX	7067
75	1	PK	Vespa XL/ Elestart	-		0,60	B8ES	2411	05	BR8EIX	5044
75	1	PK	Vespa XL/ Elestart	-		0,60	B9ES	2611	02	BR9EIX	3981
75	1	SKR	City	-		0,60	BR9ES	5722	02	BR9EIX	3981
80	1	PX	E, E Lusso, X	-		0,50	B6ES	7310	-	-	-
80	1		Sfera, Sfera Auto., Sfera RST, Sfera RST	-		0,50	B9ES	2611	02	BR9EIX	3981
80	1		Typhoon	94-		0,50	B9ES	2611	02	BR9EIX	3981
100	1		Diesis	01-		0,60	CR8EB	7784	04	CR8EIX	4218
100			Diesis	03-		0,60	BR9ES	5722	02	BR9EIX	3981
100	1		Fly	06-		0,70	CR9EB	6955	06	CR9EIX	3521
100	1		Free	02-		0,60	CR8EB	7784	04	CR8EIX	4218
100	1		Zip 4 Temps	06-08		0,70	CR9EB	6955	06	CR9EIX	3521
125	1		Ape	-		0,50	B7HS	5110	03	BR7HIX	7067
125	1		Beverly / Beverly Tourer, Beverly Light, GT	02-		0,80	CR8EB	7784	04	CR8EIX	4218
125	1		Camaby	07-		0,80	CR8EB	7784	04	CR8EIX	4218
125	1		Cosa FL 125	91-		0,50	B9ES	2611	02	BR9EIX	3981
125	1		Cosa 125 MA AE	88-		0,60	B9ES	2611	02	BR9EIX	3981
125	1		Cosa 200 FL EBC 12PS	-		0,50	B8ES	2411	05	BR8EIX	5044
125	1		ET 3	-		0,60	BR7HS	4122	03	BR7HIX	7067
125	1		ET 4 Automatique	-		0,80	CR7EB	4663	12	CR7EIX	7385
125	1		Fly	05-		0,80	CR7EB	4663	12	CR7EIX	7385
125	1		Fly E3	-		0,60	CR7EKB	4455	-	CR7EIX	7385
125	1		Hexagon	-97		0,50	B9ES	2611	02	BR9EIX	3981
125	1		Hexagon LX	94-		0,50	B9ES	2611	02	BR9EIX	3981
125	1		Hexagon LX 4T 2V AC	-		0,80	CR7EB	4663	12	CR7EIX	7385
125	1		Hexagon LX 4T / 4V H2O LC	-		0,60	CR8EB	7784	04	CR8EIX	4218
125	1		GTS Super	07-		0,80	CR8EB	7784	04	CR8EIX	4218
125	1		Liberty	98-00		0,60	CR7E	4578	12	CR7EIX	7385
125	1		Liberty	02-		0,80	CR7EB	4663	12	CR7EIX	7385
125	1		Liberty E3	-		0,60	CR7EKB	4455	-	CR7EIX	7385
125	1		Liberty Leader	01-		0,70	CR9EB	6955	06	CR9EIX	3521
125	1		Liberty S E3	-		0,60	CR7EKB	4455	-	CR7EIX	7385
125	1		MP3, MP3 ie	06-		0,60	CR8EB	7784	04	CR8EIX	4218
125	1		MP3 Hys	08-		0,80	CR8EB	7784	04	CR8EIX	4218
125	1		MP3 RL	-		0,80	CR8EB	7784	04	CR8EIX	4218
125	1		Runner	02-		0,60	CR8EB	7784	04	CR8EIX	4218
125	1		Sfera	95-		0,60	CR9E	6263	06	CR9EIX	3521
125	1		Sfera RL 4 Temps	-		0,60	CR9E	6263	06	CR9EIX	3521
125	1		Sfera RST 4 Temps	95-		0,60	CR7E	4578	12	CR7EIX	7385
125	1		Skipper, LX	93-		0,50	B9ES	2611	02	BR9EIX	3981
125	1		Skipper 4 Temps	00-		0,80	CR7EB	4663	12	CR7EIX	7385
125	1		Skr 125	93-		0,50	B9ES	2611	02	BR9EIX	3981

CYL.	Nb Cyl.	TYPE	MODÈLE		INFO			N° STOCK	N° BLISTER		N° STOCK IX
125	1		Sphera 4 Temps	95-99		0,60	CR9E	6263	06	CR9EIX	3521
125	1		Sphera 4 Temps Air	00-		0,60	CR8EB	7784	04	CR8EIX	4218
125	1		Super Hexagon GTX 4 Temps	01-		0,60	CR8EB	7784	04	CR8EIX	4218
125	1		TPH	95-		0,50	B9ES	2611	02	BR9EIX	3981
125	1		Typhoon 4T	10-		0,80	CR7EB	4663	12	CR7EIX	7385
125	1		Vespa CL/ LS/ NK Primavera/T3	-		0,50	B6HS	4510	09	BR6HIX	3419
125	1		Vespa ET 4	-		0,60	CR7E	4578	12	CR7EIX	7385
125	1		Vespa ET 4	96-		0,70	CR8EB	7784	04	CR8EIX	4218
125	1		Vespa ET 4	99-		0,80	CR7EB	4663	12	CR7EIX	7385
125	1		Vespa FL2	90-		0,60	B7HS	5110	03	BR7HIX	7067
125	1		Vespa Gandturismo	-04		0,60	CR9EB	6955	06	CR9EIX	3521
125	1		Vespa GT	03-		0,60	CR8EB	7784	04	CR8EIX	4218
125	1		Vespa GTS 125	07-		0,70	CR8EKB	4374	-	CR8EIX	4218
125	1		Vespa GTS Super 125 i.e.	10-		0,70	CR8EKB	4374	-	CR8EIX	4218
125	1		Vespa GTV 125	-		0,60	CR8EB	7784	04	CR8EIX	4218
125	1		Vespa Leader ET 4	00-		0,70	CR9EB	6955	06	CR9EIX	3521
125	1		Vespa LX	05-		0,70	CR7EB	4663	12	CR7EIX	7385
125	1		Vespa LX 125 i.e.	09-		0,70	CR8EB	7784	04	CR8EIX	4218
125	1		Vespa LXV 125	-		0,80	CR7EB	4663	12	CR7EIX	7385
125	1		Vespa PK 125	85-		0,60	BR7HS	4122	03	BR7HIX	7067
125	1		Vespa PK S Elestart	-		0,50	B6HS	4510	09	BR6HIX	3419
125	1		Vespa PK XL Elestart	-		0,60	B7ES	1111	-	BR7EIX	6664
125	1		Vespa PX	08-		0,70	BR7HS	4122	03	BR7HIX	7067
125	1		Vespa PX E, E Iris	-		0,60	B6HS	4510	09	BR6HIX	3419
125	1		Vespa PX MA AE	86-		0,50	B6HS	4510	09	BR6HIX	3419
125	1		Vespa S, Vespa S i.e.	08-		0,80	CR7EB	4663	12	CR7EIX	7385
125	1		Vespa Special ET3 Primavera	-		0,60	B7HS	5110	03	BR7HIX	7067
125	1		Vespa Special ET4 Carbu	-		0,60	CR8EB	7784	04	CR8EIX	4218
125	1		Vespa T3 Li / T3	-		0,50	B6HS	4510	09	BR6HIX	3419
125	1		Vespa T5	-		0,50	B9ES	2611	02	BR9EIX	3981
125	1		Vespa T5 Sport Elestart	-		0,60	B9ES	2611	02	BR9EIX	3981
125	1		Vespa XL Plurimat Elestart	-		0,60	B7HS	5110	03	BR7HIX	7067
125	1		X7	07-		0,80	CR8EB	7784	04	CR8EIX	4218
125	1		X7 Evo 125 i.e.	07-		0,70	CR8EKB	4374	-	CR8EIX	4218
125	1		X8	-		0,70	CR9EB	6955	06	CR9EIX	3521
125	1		X8 Street	-		0,80	CR7EB	4663	12	CR7EIX	7385
125	1		X9	00-02		0,70	CR9EB	6955	06	CR9EIX	3521
125	1		X9	02-		0,60	CR8EB	7784	04	CR8EIX	4218
125	1		X-Evo	06-		0,60	CR8EB	7784	04	CR8EIX	4218
125	1	L	Granturismo	04-		0,70	CR9EB	6955	06	CR9EIX	3521
125	1	LX	Super LX	00-		0,70	CR9EB	6955	06	CR9EIX	3521
125	1	LX2		97-		0,50	B9ES	2611	02	BR9EIX	3981
125	1	LX4		98-00		0,60	CR7E	4578	12	CR7EIX	7385
125	1	ST	Skipper Leader	00-		0,70	CR9EB	6955	06	CR9EIX	3521
125	1	XR	Typhoon	-		0,50	B9ES	2611	02	BR9EIX	3981
125	1	ZIP		-		0,70	CR7EB	4663	12	CR7EIX	7385
125	1	ZIP	New Edge Leader 2 Temps	01-		0,60	B9ES	2611	02	BR9EIX	3981
125	1	ZIP	New Edge Leader 4 Temps	00-		0,70	CR9EB	6955	06	CR9EIX	3521
150			Cosa	-		0,60	BR9ES	5722	02	BR9EIX	3981
150	1		Fly	08-		0,80	CR7EB	4663	12	CR7EIX	7385
150	1		Hexagon	94-		0,50	B9ES	2611	02	BR9EIX	3981
150	1		Liberty	02-		0,80	CR7EB	4663	12	CR7EIX	7385
150	1		Piaggio	-		0,50	B9ES	2611	02	BR9EIX	3981
150	1		Skipper	93-		0,60	B9ES	2611	02	BR9EIX	3981
150	1		Skipper ST 4T	-00		0,70	BR9ES	5722	02	BR9EIX	3981
150	1		Skipper ST 4T	01-		0,80	CR7EB	4663	12	CR7EIX	7385
150	1		SKR 150	98-		0,50	B9ES	2611	02	BR9EIX	3981
150	1		Vespa culot court	-		0,50	B6HS	4510	09	BR6HIX	3419
150	1		Vespa culot long	-		0,50	B6ES	7310	-	-	-
150	1		Vespa ET 4	-01		0,60	CR7E	4578	12	CR7EIX	7385
150	1		Vespa ET 4	01-02		0,60	CR8EB	7784	04	CR8EIX	4218
150	1		Vespa ET 4	02-		0,80	CR7EB	4663	12	CR7EIX	7385
150	1		Vespa LX	08-		0,80	CR7EB	4663	12	CR7EIX	7385
150	1		Vespa LX 150 i.e.	09-		0,80	CR7EB	4663	12	CR7EIX	7385
150	1		Vespa LXV, Vespa S	-		0,80	CR7EB	4663	12	CR7EIX	7385
150	1		Vespa S i.e.	08-		0,80	CR7EB	4663	12	CR7EIX	7385
150	1	PX	Vespa PX Kat	-		0,70	BR6HS	3922	09	BR6HIX	3419
150	1	PX	Vespa PX MA AE	86-		0,50	B6HS	4510	09	BR6HIX	3419
150	1		X8 Street	-		0,80	CR7EB	4663	12	CR7EIX	7385
150	1		Vespa, Vespa GT	-		0,50	B6HS	4510	09	BR6HIX	3419
175	1		Vespa	-		0,50	B6HS	4510	09	BR6HIX	3419
180	1		Hexagon LXT	98-00		0,50	B9ES	2611	02	BR9EIX	3981
180	1		Super Hexagon LXT 180	01-		0,60	CR8EB	7784	04	CR8EIX	4218
180	1		Vespa SS	-		0,50	B6HS	4510	09	BR6HIX	3419
180	1		X9 4 Temps Amalfi	01-		0,60	CR8EB	7784	04	CR8EIX	4218

PIAGGIO





CYL.	Nb Cyl.	TYPE	MODÈLE		INFO			N° STOCK	N° BLISTER		N° STOCK IX
190		Ape		-		0,70	BR7HS	4122	03	BR7HIX	7067
200	1	Beverly		02-		0,60	CR8EB	7784	04	CR8EIX	4218
200	1	Camaby		07-		0,60	CR8EB	7784	04	CR8EIX	4218
200	1	Cosa		-		0,50	B8ES	2411	05	BR8EIX	5044
200	1	Cosa MA AE		88-		0,60	BR8ES	5422	05	BR8EIX	5044
200	1	Cosa (cylindre Alu 12PS)		93-97		0,60	BR8ES	5422	05	BR8EIX	5044
200	1	Cosa FL		91-		0,50	B8ES	2411	05	BR8EIX	5044
200	1	Cosa II MA AE		88-		0,60	BR8ES	5422	05	BR8EIX	5044
200	1	DN, DS		-		0,50	BR7ES	5122	-	BR7EIX	6664
200	1	Leader LXT		00-		0,70	CR9EB	6955	06	CR9EIX	3521
200	1	Liberty		04-		0,80	CR7EB	4663	12	CR7EIX	7385
200	1	PE		-		0,50	BR7ES	5122	-	BR7EIX	6664
200	1	Vespa DN, DS, E		-		0,50	B5ES	6410	-	-	-
200	1	Vespa Granturimo L		-		0,60	CR7EKB	4455	-	CR7EIX	7385
200	1	Vespa PX E/Iris/Iris Elestart		-		0,60	B7ES	1111	-	BR7EIX	6664
200	1	Vespa PX MA AE		86-		0,50	B6ES	7310	-	-	-
200	1	Vespa Rally		-		0,50	BR7ES	5122	-	BR7EIX	6664
200	1	Vespa TX Elestart		-		0,60	B7ES	1111	-	BR7EIX	6664
200	1	X8		05-		0,60	CR7EKB	4455	-	CR7EIX	7385
220		Ape		-		0,70	BR7HS	4122	03	BR7HIX	7067
250	1	Beverly		03-		0,70	PMR8B	6378	-	-	-
250	1	Beverly GTS 4 Temps Injection		06-		0,70	PMR8B	6378	-	-	-
250	1	Camaby		08-		0,70	PMR8B	6378	-	-	-
250	1	Cruiser		03-		0,70	PMR8B	6378	-	-	-
250	1	Hexagon GT, X		98-01		0,90	DPR6EA-9	5531	-	-	-
250	1	MP3 ie /RST		06-		0,70	PMR8B	6378	-	-	-
250	1	MP3 ie		-		0,70	CR9EB	6955	06	CR9EIX	3521
250	1	MP3 RL ie		-		0,70	PMR8B	6378	-	-	-
250		Super Hexagon GTX		00-		0,70	CR9E	6263	06	CR9EIX	3521
250	1	Tourer		03-		0,70	PMR8B	6378	-	-	-
250	1	Vespa GTS ie		06-		0,70	PMR8B	6378	-	-	-
250	1	Vespa GTV Via Montenapoleone		11-		0,70	PMR8B	6378	-	-	-
250	1	X-Evo		-		0,70	PMR8B	6378	-	-	-
250	1	X7		07-		0,70	PMR8B	6378	-	-	-
250	1	X8 4 Temps Injection		06-		0,70	PMR8B	6378	-	-	-
250	1	X9 4 Temps		00-03		0,90	DPR7EA-9	5129	13	DPR7EIX-9	7803
250	1	X9 Evolution		-		0,60	CR8EB	7784	04	CR8EIX	4218
250	1	X9 Evo		07-		0,70	PMR8B	6378	-	-	-
300	1	Beverly 300 i.e.		11-		0,70	CR8EKB	4374	-	CR8EIX	4218
300	1	Beverly Tourer 300 i.e.		10-		0,70	CR8EKB	4374	-	CR8EIX	4218
300	1	Camaby		09-		0,70	CR8EKB	4374	-	CR8EIX	4218
300	1	Camaby Cruiser 300 i.e.		10-		0,70	CR8EKB	4374	-	CR8EIX	4218
300	1	Vespa GTS Super		08-		0,70	CR8EKB	4374	-	CR8EIX	4218
300	1	Vespa GTS Super Sport / ie		11-		0,70	CR8EKB	4374	-	CR8EIX	4218
300	1	Vespa GTV via Montenapoleone		10-		0,70	CR8EKB	4374	-	CR8EIX	4218
300	1	MP3 300 i.e. / LT 300 i.e.		10-		0,70	CR8EKB	4374	-	CR8EIX	4218
300	1	MP3 300 i.e. Hybrid		11-		0,70	CR8EKB	4374	-	CR8EIX	4218
300	1	MP3 LT		-		0,70	CR8EKB	4374	-	CR8EIX	4218
300	1	MP3 LT 300 i.e. Hybrid		11-		0,70	CR8EKB	4374	-	CR8EIX	4218
300	1	X7 EVO i.e.		10-		0,70	CR8EKB	4374	-	CR8EIX	4218
400	1	Beverly / Tourer		06-		0,70	CR7EKB	4455	-	CR7EIX	7385
400	1	MP3		07-		0,80	CR7EKB	4455	-	CR7EIX	7385
400	1	MP3 LT 400 i.e.		09-		0,80	CR7EKB	4455	-	CR7EIX	7385
400		MP3 LT Sport ie		11-		0,70	CR7EKB	4455	-	CR7EIX	7385
400	1	MP3 RL ie		-		0,70	CR7EKB	4455	-	CR7EIX	7385
400	1	MP3 RST		07-		0,70	CR7EKB	4455	-	CR7EIX	7385
400	1	X-Evo		07-		0,80	CR7EKB	4455	-	CR7EIX	7385
400	1	X8		06-		0,70	CR7EKB	4455	-	CR7EIX	7385
460		B500		03-		0,80	CR7EKB	4455	-	CR7EIX	7385
500	1	Beverly		03-		0,70	CR7EKB	4455	-	CR7EIX	7385
500	1	Beverly Cruiser		07-		0,70	CR7EKB	4455	-	CR7EIX	7385
500	1	X9, X9 Evo ABS		02-		0,70	CR7EKB	4455	-	CR7EIX	7385

PIONEER

125		Nevada 125, Torro 125		08-		0,70	D8EA	2120	11	DR8EIX	6681
-----	--	-----------------------	--	-----	--	------	------	------	----	--------	------





POLARIS - Quad

50	1	Predator AR03-01		03-		0,80	BPR7HS	6422	14	BPR7HIX	5944
50	1	Scrambler 4x2, Predator		01-		0,70	BPR7HS	6422	14	BPR7HIX	5944
50	1	Youth Scrambler AR03		01-		0,80	BPR7HS	6422	14	BPR7HIX	5944
90	1	Scrambler 4x2, Sportsman 4x2		01-		0,70	BPR7HS	6422	14	BPR7HIX	5944
90	1	Predator 4x2		03-		0,70	BPR7HS	6422	14	BPR7HIX	5944

CYL.	Nb Cyl.	TYPE	MODÈLE		INFO			N° STOCK	N° BLISTER		N° STOCK IX
90	1	Youth Predator	AR07	03-	0,80		BPR7HS	6422	14	BPR7HIX	5944
90	1	Youth Scrambler / Sportsman	AR07	01-	0,80		BPR7HS	6422	14	BPR7HIX	5944
121	1	Pro X 120 2 Temps		05-	0,70		B6ES	7310	-	-	-
200		Phoenix		-	0,70		CR6HSA	2983	-	CR6HIX	7274
200	1	Phönix	200	05-	0,60		CR7HSA	4549	07	CR7HIX	7544
200		Sawtooth		06-	0,70		CR7HSA	4549	07	CR7HIX	7544
250	1	2x4		93	0,60		BR8ES	5422	05	BR8EIX	5044
250	1	Scrambler		89-	0,60		BR8ES	5422	05	BR8EIX	5044
250	1	Trail Blazer, Trail Boss		90-97	0,60		BR8ES	5422	05	BR8EIX	5044
250		Xplorer 4x2		00-02	0,70		BR8ES	5422	05	BR8EIX	5044
300		Big Boss		93-	0,60		BR8ES	5422	05	BR8EIX	5044
300		Hawkeye		06-	0,90		CR8E	1275	04	CR8EIX	4218
300	1	2x4		94-95	0,60		BR8ES	5422	05	BR8EIX	5044
300	1	4x4		95	0,60		BR8ES	5422	05	BR8EIX	5044
300		Xpress, Xplorer		96-00	0,60		BR8ES	5422	05	BR8EIX	5044
325	1	ACE EFI		16-	0,80		MR7F	95897	-	-	-
325	1	Hawkeye 2x4		15-	0,80		MR7F	95897	-	-	-
325	1	Sportsman ACE / ACE Euro		14-	0,80		MR7F	95897	-	-	-
325	1	Sportsman ACE EFI / ACE HD		15-	0,80		MR7F	95897	-	-	-
325	1	Sportsman ETX EFI / ETX EFI MD		15-	0,80		MR7F	95897	-	-	-
325		Trail Boss 4x2		-02	0,90		BKR6E	6962	-	BKR6EIX	6418
325		Xpedition 4x4		-02	0,80		BKR6E	6962	-	BKR6EIX	6418
325	HDS	Magnum 4x2		-02	0,90		BKR6E	6962	-	BKR6EIX	6418
330	HDS	Magnum 4x2		03-	0,80		BKR6E	6962	-	BKR6EIX	6418
325	HDS	Magnum 4x4		-02	0,90		BKR6E	6962	-	BKR6EIX	6418
330	HDS	Magnum 4x4		03-	0,80		BKR6E	6962	-	BKR6EIX	6418
330	1	Magnum 330 4x4		05-	0,60		BKR6ES	3783	-	BKR6EIX	6418
330		Trail Boss 4x2		03-	0,80		BKR6E	6962	-	BKR6EIX	6418
330	1	Trail Boss 330		05-	0,60		BKR6ES	3783	-	BKR6EIX	6418
335		Sportsman 4x4		-00	0,70		BKR7E	6097	-	BKR7EIX	2667
350		Big Boss		93-	0,60		BR8ES	5422	05	BR8EIX	5044
350	1	Euro Trail Boss		92	0,60		BR8ES	5422	05	BR8EIX	5044
350	1	Trail Boss EC35		90-	0,50		BR8ES	5422	05	BR8EIX	5044
400	1	400L		94-96	0,60		BR8ES	5422	05	BR8EIX	5044
400	1	Big Boss 400L		95-98	0,70		BR8ES	5422	05	BR8EIX	5044
400	1	Norwegian 400L		96	0,60		BR8ES	5422	05	BR8EIX	5044
400	1	Scrambler		95-00	0,70		BR8ES	5422	05	BR8EIX	5044
400		Sport 4x2		-00	0,70		BR8ES	5422	05	BR8EIX	5044
400	1	Sport 400L		94-97	0,60		BR8ES	5422	05	BR8EIX	5044
400	1	Sportsman		95-97	0,70		BR8ES	5422	05	BR8EIX	5044
400		Sportman 4x4		03-	0,60		BKR5E	7938	-	BKR5EIX	6341
400		Trail Blazer 4x2		03-	0,70		BR8ES	5422	05	BR8EIX	5044
400	1	Xplorer		95-00	0,70		BR8ES	5422	05	BR8EIX	5044
400	1	Xpress		96-98	0,70		BR8ES	5422	05	BR8EIX	5044
425		Expedition EH42		01-	0,60		BKR5E	7938	-	BKR5EIX	6341
425	1	Magnum		95	0,60		BKR6E	6962	-	BKR6EIX	6418
425	1	Magnum		96-98	0,60		BKR5E	7938	-	BKR5EIX	6341
425		Ranger EH42		02-	0,60		BKR5E	7938	-	BKR5EIX	6341
425		Sportsman		01-04	0,60		BKR5E	7938	-	BKR5EIX	6341
425		Xpedition 4x4		-00	0,60		BKR5E	7938	-	BKR5EIX	6341
450	1	450 HO 2x4 MD		16-	0,80		MR7F	95897	-	-	-
450		Sportsman EH 460		06-	0,80		CR8E	1275	04	CR8EIX	4218
450	1	Sportsman EPS Quad / HO / Tractor		16-	0,80		MR7F	95897	-	-	-
500	1	ATP 500		05-	0,60		BKR6ES	3783	-	BKR6EIX	6418
500	1	Big Boss		98-00	0,70		BKR5E	7938	-	BKR5EIX	6341
500	1	LUH 6x6 PSS (C02CL50AB)		02	0,60		BKR5E	7938	-	BKR5EIX	6341
500		Predator 4x2		03-	0,80		DCPR8E	4339	-	DCPR8EIX	6546
500	1	Pro ATV 4x4 PPS (C02CD50AC)		02	0,60		BKR5E	7938	-	BKR5EIX	6341
500		Ranger 4x4		02-	0,70		BKR5E	7938	-	BKR5EIX	6341
500		Ranger 6x6		99-	0,70		BKR5E	7938	-	BKR5EIX	6341
500	1	Scrambler		97-	0,70		BKR5E	7938	-	BKR5EIX	6341
500		Scrambler 4x4		10-	0,90		BKR6E	6962	-	BKR6EIX	6418
500	1	Sportsman		96-05	0,60		BKR5E	7938	-	BKR5EIX	6341
500	2	Sportsman 6x6		00-	0,70		BKR5E	7938	-	BKR5EIX	6341
500	2	Sportsman 6x6		05-	0,60		BKR6ES	3783	-	BKR6EIX	6418
500		Task Force Utility EH50		02-	0,60		BKR5E	7938	-	BKR5EIX	6341
500	1	Xplorer		97-98	0,60		BKR5E	7938	-	BKR5EIX	6341
500	HDS	Magnum 4x4		00-	0,70		BKR5E	7938	-	BKR5EIX	6341
500	RSE	Sportsman 4x4		00-	0,70		BKR5E	7938	-	BKR5EIX	6341
550		XP		09-	0,90		LZKAR7A	6799	-	-	-
570	1	ACE 570 EFI Euro / EFI HD / EFI MD		16-	0,80		MR7F	95897	-	-	-
570	1	Sportsman ACE EFI / ACE Euro / ACE HD		15-	0,80		MR7F	95897	-	-	-
570	1	Sportsman EFI / EFI HD		14-16	0,80		MR7F	95897	-	-	-
570	1	Sportsman EFI EPS / EPS Forest		14-	0,80		MR7F	95897	-	-	-
570	1	Sportsman EFI EPS Forest Quad / EPS MD		15-	0,80		MR7F	95897	-	-	-
570	1	Sportsman EFI MD / EFI UTE HD		15-16	0,80		MR7F	95897	-	-	-

POLARIS - Quad





Bougies d'allumage

CYL.	Nb Cyl.	TYPE	MODÈLE		INFO		N° STOCK	N° BLISTER		N° STOCK IX
570	1	Sportsman EFI Touring EU		15-		0,80	MR7F 95897	-	-	-
570	1	Sportsman EFI UTE HD EPS		14-		0,80	MR7F 95897	-	-	-
570	1	Sportsman EFI UTE MD / UTE Tractor		16-		0,80	MR7F 95897	-	-	-
570	1	Sportsman EFI X2 EPS		15-16		0,80	MR7F 95897	-	-	-
570	1	Sportsman EFI X2 EPS Europe		15-		0,80	MR7F 95897	-	-	-
570	1	Sportsman EPS Quad / UTE Quad		16-		0,80	MR7F 95897	-	-	-
570	1	Sportsman Forest		14-		0,80	MR7F 95897	-	-	-
570	1	Sportsman HD		15-		0,80	MR7F 95897	-	-	-
570	1	Sportsman SP / SP EPS, Quad / SP MD		15-16		0,80	MR7F 95897	-	-	-
570	1	Sportsman SP Touring		15-		0,80	MR7F 95897	-	-	-
570	1	Sportsman Touring EFI		14-		0,80	MR7F 95897	-	-	-
570	1	Sportsman Touring EFI EPS MD - R01		16-		0,80	MR7F 95897	-	-	-
570	1	Sportsman Touring EFI INTL		14-		0,80	MR7F 95897	-	-	-
570	1	Sportsman Touring EFI MD		15-		0,80	MR7F 95897	-	-	-
570	1	Sportsman Touring EFI/EPS		15-16		0,80	MR7F 95897	-	-	-
570	1	Sportsman Touring Quad EPS / Tractor		16-		0,80	MR7F 95897	-	-	-
570	1	Sportsman Touring Tractor EFI EPS		16-		0,80	MR7F 95897	-	-	-
600		Sportsman 4x4		03-05		0,70	BKR7E 6097	-	BKR7EIX	2667
700		Sportsman 4x4		02-05		0,70	BKR7E 6097	-	BKR7EIX	2667
700		Ranger 4x4, 6x6		06-		0,70	BKR7E 6097	-	BKR7EIX	2667
800		Sportsman 4x4		05-		0,70	BKR7E 6097	-	BKR7EIX	2667
850	2	Sportsman Touring		10-		0,90	LZKAR7A 6799	-	-	-
850	2	XP		09-		0,90	LZKAR7A 6799	-	-	-
900	2	ACE EFI EPS		16-		0,80	MR7F 95897	-	-	-



POLARIS - SSV





-		UTV 2x4 24PS 4Tps		-		0,60	BKR5E 7938	-	BKR5EIX	6341
-		UTV 4x4 30PS 4Tps, UTV 6x6 30PS 4Tps		-		0,60	BKR5E 7938	-	BKR5EIX	6341
325	1	M1400 Gas, Ranger ETX EU		15-		0,80	MR7F 95897	-	-	-
325	1	Ranger ETX		15-16		0,80	MR7F 95897	-	-	-
400	1	Ranger 4x4		14		0,90	BKR6E 6962	-	BKR6EIX	6418
400	1	Ranger 4x4 HO		10-12		0,90	BKR6E 6962	-	BKR6EIX	6418
400	1	Ranger Midsize		13		0,90	BKR6E 6962	-	BKR6EIX	6418
500		Hauler Light Utility EH50		02-		0,60	BKR5E 7938	-	BKR5EIX	6341
500	1	Ranger		99		0,80	BKR5E 7938	-	BKR5EIX	6341
500	1	Ranger 2x4		04-09		0,70	BKR5E 7938	-	BKR5EIX	6341
500	1	Ranger 4x4		04-07		0,70	BKR5E 7938	-	BKR5EIX	6341
500	1	Ranger 4x4 Crew		11-12		0,70	BKR5E 7938	-	BKR5EIX	6341
500	1	Ranger 4x4 Crew		12-		0,80	BKR5E 7938	-	BKR5EIX	6341
500	1	Ranger 4x4 EFI		06-09		0,70	BKR6E 6962	-	BKR6EIX	6418
500	1	Ranger 4x4 EFI		10-12		0,70	BKR5E 7938	-	BKR5EIX	6341
500	1	Ranger 6x6		04-05		0,70	BKR5E 7938	-	BKR5EIX	6341
570	1	570 EFI/EPS Forest Tractor		15-		0,80	MR7F 95897	-	-	-
570	1	570 TR PRM PS MD, Ranger		15-		0,80	MR7F 95897	-	-	-
570	1	Ranger EFI Crew		14		0,60	CPR8E 7411	-	-	-
570	1	Ranger EFI Full Size Crew		15-		0,80	MR7F 95897	-	-	-
570	1	Ranger Full Size		15-16		0,80	MR7F 95897	-	-	-
570	1	Ranger INTL		14-		0,80	MR7F 95897	-	-	-
570	1	Ranger Crew EFI		14-15		0,80	MR7F 95897	-	-	-
570	1	RGR, RGR EFI Crew		16-		0,80	MR7F 95897	-	-	-
570	1	RGR EU, RGR Full Size Crew		16-		0,80	MR7F 95897	-	-	-
570	1	RZR RZR		14-16		0,80	MR7F 95897	-	-	-
570	1	RZR RZR EU		15-		0,80	MR7F 95897	-	-	-
653	2	Ranger TM (A04RB63AA)		04		0,70	BPR4EY 2128	-	-	-
700	2	Ranger 4x4 EFI		09		0,70	BKR7E 6097	-	BKR7EIX	2667
700	2	Ranger 4x4 EFI / LE		07		0,70	BKR7E 6097	-	BKR7EIX	2667
700	2	Ranger 4x4 EFI / XP		08		0,70	BKR7E 6097	-	BKR7EIX	2667
700	2	Ranger 4x4 EFI Crew		08-09		0,70	BKR7E 6097	-	BKR7EIX	2667
700	2	Ranger 6x6 EFI		06-09		0,70	BKR7E 6097	-	BKR7EIX	2667
700	2	Ranger XP (R05RD68AA)		05		0,70	BKR7E 6097	-	BKR7EIX	2667
700	2	Ranger XP 4x4 (R06RD68AA)		06		0,70	BKR7E 6097	-	BKR7EIX	2667
800	2	Ranger		14		0,70	BKR7E 6097	-	BKR7EIX	2667
800	2	Ranger EFI Midsize		13-14		0,70	BKR7E 6097	-	BKR7EIX	2667
800	2	Ranger 4x4 EFI, Ranger 4x4 EFI Crew		10		0,70	BKR7E 6097	-	BKR7EIX	2667
800	2	Ranger 4x4 EFI		11		0,70	BKR7E 6097	-	BKR7EIX	2667
800	2	Ranger 4x4 EFI Crew		11-14		0,70	BKR7E 6097	-	BKR7EIX	2667
800	2	Ranger 6x6 EFI		10-14		0,70	BKR7E 6097	-	BKR7EIX	2667
800	2	Ranger XP		12		0,70	BKR7E 6097	-	BKR7EIX	2667
800	2	RZR RZR EFI		08-11		0,70	BKR7E 6097	-	BKR7EIX	2667
800	2	RZR RZR EFI / EPS		12-14		0,70	BKR7E 6097	-	BKR7EIX	2667
800	2	RZR Ranger EFI - White lightning/black		12-		0,70	BKR7E 6097	-	BKR7EIX	2667
800	2	RZR 4 RZR 4 EFI		10		0,70	BKR7E 6097	-	BKR7EIX	2667
800	2	RZR 4 RZR 4 EFI		12-14		0,70	BKR7E 6097	-	BKR7EIX	2667
800	2	RZR 4 Ranger EFI EPS INTL		12-		0,70	BKR7E 6097	-	BKR7EIX	2667





CYL.	Nb Cyl.	TYPE	MODÈLE		INFO			N° STOCK	N° BLISTER		N° STOCK IX
800	2	RZR 4	RZR 4 EFI EPS INTL	12		0,70	BKR7E	6097	-	BKR7EIX	2667
800	2	RZR 4	RZR 4 EPS RGE, RZR 4 INTL	11		0,70	BKR7E	6097	-	BKR7EIX	2667
800	2	RZR S	RZR S EFI	09-13		0,70	BKR7E	6097	-	BKR7EIX	2667
800	2	RZR S	RZR S EFI INTL	09-10		0,70	BKR7E	6097	-	BKR7EIX	2667
800	2	RZR S	RZR S EPS INTL	11		0,70	BKR7E	6097	-	BKR7EIX	2667
800	2	RZR S	Ranger EFI - Indy red	12-		0,70	BKR7E	6097	-	BKR7EIX	2667
800	2	RZR S	Ranger EFI - Vogue silver/indy red	12-		0,70	BKR7E	6097	-	BKR7EIX	2667
800	2		SDi 2 Temps	12-		0,70	GR9A-EG	94841	-	-	-
900	2		Ranger Crew All Options	14-16		0,80	MR7F	95897	-	-	-
900	2		Ranger XP All Options	13-16		0,80	MR7F	95897	-	-	-
900	2		Ranger XP EU	15-16		0,80	MR7F	95897	-	-	-
900	2	RZR	RZR 50/55 Inch, RZR 60 Inch / PS, EU	15-16		0,80	MR7F	95897	-	-	-
900	2	RZR	RZR 60 Inch PS INTL	15-		0,80	MR7F	95897	-	-	-
900	2	RZR	RZR XP 4 EFI	13-		0,80	MR7F	95897	-	-	-
900	2	RZR	RZR XP EFI	12-13		0,80	MR7F	95897	-	-	-
900	2	RZR	RZR XP EPS INTL	13-		0,80	MR7F	95897	-	-	-
900	2	RZR 4	RZR 4	14-16		0,80	MR7F	95897	-	-	-
900	2	RZR 4	RZR 4 XP	11-13		0,80	MR7F	95897	-	-	-
900	2	RZR 4	RZR 4 XP Jagged X, RZR 4 XP PS INTL	13-		0,80	MR7F	95897	-	-	-
1000	2	RZR	RZR 1000 60 Inch All Options	15-		0,80	MR7F	95897	-	-	-
1000	2	RZR	RZR XP	14-16		0,80	MR7F	95897	-	-	-
1000	2	RZR	RZR XP 1000 INTL	15-		0,80	MR7F	95897	-	-	-
1000	2	RZR	RZR XP 4 1000	15-16		0,80	MR7F	95897	-	-	-











POLARIS - Motoneige





120	1	INDY	120 Indy / INTL	14		0,90	BR6ES	4922	-	-	-
120	1	RUSH	120 Pro / INTL	12		0,90	BR6ES	4922	-	-	-
120	1	RUSH	120 Pro-R / INTL	13		0,90	BR6ES	4922	-	-	-
120	1		120	07		0,90	BR6ES	4922	-	-	-
120	1		120 / Euro	09		0,90	BR6ES	4922	-	-	-
120	1		120 Assault / INTL	11		0,90	BR6ES	4922	-	-	-
120	1		120 Dragon / Euro	08		0,90	BR6ES	4922	-	-	-
120	1		120 Dragon / INTL	10		0,90	BR6ES	4922	-	-	-
120	1		120 Pro X	04-06		0,90	BR6ES	4922	-	-	-
120	1		120 XC SP	01-03		0,90	BR6ES	4922	-	-	-
120	1		120 XCR	00		0,90	BR6ES	4922	-	-	-
250	1		250 Star, 250 Startrak	88-90		0,80	BR8ES	5422	05	BR8EIX	5044
340	1		340	08		0,80	BR8ES	5422	05	BR8EIX	5044
340	1		340 Classic	05-06		0,80	BR8ES	5422	05	BR8EIX	5044
340	1		340 Edge LX, 340 Edge Touring	07		0,80	BR8ES	5422	05	BR8EIX	5044
340	1		340 Edge/Edge Classic	03		0,80	BR8ES	5422	05	BR8EIX	5044
340	1	INDY	340 Indy	99		0,80	BR8ES	5422	05	BR8EIX	5044
340	1	INDY	340 Indy Deluxe	99-02		0,80	BR8ES	5422	05	BR8EIX	5044
340	1	INDY	340 Indy Touring	99-03		0,80	BR8ES	5422	05	BR8EIX	5044
340	1	INDY	340 Indy/INT'L/Classic	04		0,80	BR8ES	5422	05	BR8EIX	5044
340	2		340 Lite	91-98		0,80	BR8ES	5422	05	BR8EIX	5044
340	2		340 Lite Deluxe	92-98		0,80	BR8ES	5422	05	BR8EIX	5044
340	2		340 Lite GT	91-97		0,80	BR8ES	5422	05	BR8EIX	5044
340	2		340 Lite Touring	98		0,80	BR8ES	5422	05	BR8EIX	5044
340	2		340 Sport	88-89		0,70	BR9ES	5722	02	BR9EIX	3981
340	2		340 Sprint ES	88-90		0,70	BR9ES	5722	02	BR9EIX	3981
340	2		340 Star Lite	91-95		0,80	BR8ES	5422	05	BR8EIX	5044
340	2		340 Star Lite GT	93-94		0,80	BR8ES	5422	05	BR8EIX	5044
340	1		340 Touring	06		0,80	BR8ES	5422	05	BR8EIX	5044
340	1		340 Touring/INT'L	04		0,80	BR8ES	5422	05	BR8EIX	5044
340	1		340 Transport/Euro	08		0,80	BR8ES	5422	05	BR8EIX	5044
400	2		400	88-90		0,70	BR9ES	5722	02	BR9EIX	3981
400	2		400	91		0,80	BR8ES	5422	05	BR8EIX	5044
400	2		400 Classic, 400 SKS	88		0,70	BR9ES	5722	02	BR9EIX	3981
400	2		400 XC	91		0,70	BR9ES	5722	02	BR9EIX	3981
440	2	INDY	440 Indy	98		0,80	BR8ES	5422	05	BR8EIX	5044
440	2	IQ	440 IQ	05-06		0,60	BR10EG	3830	-	-	-
440	2	IQ	440 IQ / Euro	07		0,60	BR10EG	3830	-	-	-
440	2		440	92		0,80	BR8ES	5422	05	BR8EIX	5044
440	2		440 L/C	93-97		0,80	BR8ES	5422	05	BR8EIX	5044
440	2		440 Longtrak	88		0,70	BR9ES	5722	02	BR9EIX	3981
440	2		440 Longtrak/Reverse	89		0,70	BR9ES	5722	02	BR9EIX	3981
440	2		440 Pro X	01-03		0,60	BR10EG	3830	-	-	-
440	2		440 Pro X Fan Cooled	02-03		0,70	BR9ES	5722	02	BR9EIX	3981
440	2		440 Pro XR	04		0,60	BR10EG	3830	-	-	-
440	2		440 SKS	93-95		0,80	BR8ES	5422	05	BR8EIX	5044
440	2		440 Sport	90		0,70	BR9ES	5722	02	BR9EIX	3981
440	2		440 Sport	91-99		0,80	BR8ES	5422	05	BR8EIX	5044
440	2		440 Sport GT	90		0,70	BR9ES	5722	02	BR9EIX	3981

CYL.	Nb Cyl.	TYPE	MODÈLE		INFO			N° STOCK	N° BLISTER		N° STOCK IX
440	2		440 Sport GT	91-92		0,80	BR8ES	5422	05	BR8EIX	5044
440	2		440 Sport SKS	94		0,80	BR8ES	5422	05	BR8EIX	5044
440	2		440 Sport Touring	95-99		0,80	BR8ES	5422	05	BR8EIX	5044
440	2		440 Sport (Lite)	00		0,70	BR9ES	5722	02	BR9EIX	3981
440	2		440 Super Sport	94-96		0,80	BR8ES	5422	05	BR8EIX	5044
440	2		440 Transport	96-99		0,80	BR8ES	5422	05	BR8EIX	5044
440	2		440 XC	97		0,70	BR9ES	5722	02	BR9EIX	3981
440	2		440 XC SP	00		0,60	BR10EG	3830	-	-	-
440	2		440 XCF	97-98		0,80	BR8ES	5422	05	BR8EIX	5044
440	2		440 XCF	99		0,70	BR9ES	5722	02	BR9EIX	3981
440	2		440 XCR	92-99		0,70	BR9ES	5722	02	BR9EIX	3981
440	2		440 XCR SP	95-96		0,70	BR9ES	5722	02	BR9EIX	3981
440	2		440 XCR SP	99		0,60	BR10EG	3830	-	-	-
450	2		450 XCF Edge	00		0,70	BR9ES	5722	02	BR9EIX	3981
450	2		450 XCF SP	99		0,70	BR9ES	5722	02	BR9EIX	3981
450	2		450 XCF SP Edge	01		0,70	BR9ES	5722	02	BR9EIX	3981
500	2	INDY	500 Indy	97-02		0,80	BR8ES	5422	05	BR8EIX	5044
500	2	INDY	500 Indy	05-06		0,80	BR8ES	5422	05	BR8EIX	5044
500	2	RMK	500 Carb RMK	96		0,80	BR8ES	5422	05	BR8EIX	5044
500	2	RMK	500 RMK	96-99		0,80	BR8ES	5422	05	BR8EIX	5044
500	2	RMK	500 RMK	00		0,70	BR9ES	5722	02	BR9EIX	3981
500	2	RMK	500 RMK 136	01-02		0,70	BR9ES	5722	02	BR9EIX	3981
500	2	RMK	500 Trail RMK	98		0,80	BR8ES	5422	05	BR8EIX	5044
500	2		500 Carb	95-96		0,80	BR8ES	5422	05	BR8EIX	5044
500	2		500 Carb SKS	96		0,80	BR8ES	5422	05	BR8EIX	5044
500	2		500	89-90		0,70	BR9ES	5722	02	BR9EIX	3981
500	2		500	91-92		0,80	BR8ES	5422	05	BR8EIX	5044
500	2		500 Classic	89-90		0,70	BR9ES	5722	02	BR9EIX	3981
500	2		500 Classic	91-02		0,80	BR8ES	5422	05	BR8EIX	5044
500	2		500 Classic	03		0,60	BR10EG	3830	-	-	-
500	2		500 Classic	04-06		0,80	BR8ES	5422	05	BR8EIX	5044
500	2		500 Classic Touring	93-03		0,80	BR8ES	5422	05	BR8EIX	5044
500	2		500 Edge	03-04		0,80	BR8ES	5422	05	BR8EIX	5044
500	2		500 EFI	93-97		0,80	BR8ES	5422	05	BR8EIX	5044
500	2		500 EFI SKS	93-96		0,80	BR8ES	5422	05	BR8EIX	5044
500	2		500 EFI SKS PDL TRK	95		0,80	BR8ES	5422	05	BR8EIX	5044
500	2		500 SKS	89-90		0,70	BR9ES	5722	02	BR9EIX	3981
500	2		500 SKS	91-92		0,80	BR8ES	5422	05	BR8EIX	5044
500	2		500 SKS	95		0,80	BR8ES	5422	05	BR8EIX	5044
500	2		500 SKS	97		0,80	BR8ES	5422	05	BR8EIX	5044
500	2		500 SKS Euro	00-02		0,70	BR9ES	5722	02	BR9EIX	3981
500	2		500 SP	89-90		0,70	BR9ES	5722	02	BR9EIX	3981
500	2		500 SP	91-92		0,80	BR8ES	5422	05	BR8EIX	5044
500	2		500 SP EFI, 500 SPX	92		0,80	BR8ES	5422	05	BR8EIX	5044
500	2		500 SuperSport	97-98		0,80	BR8ES	5422	05	BR8EIX	5044
500	2		500 Supertrak	92		0,80	BR8ES	5422	05	BR8EIX	5044
500	2		500 Trail, 500 Trail Deluxe	88-90		0,70	BR9ES	5722	02	BR9EIX	3981
500	2		500 Trail	91-99		0,80	BR8ES	5422	05	BR8EIX	5044
500	2		500 Trail Deluxe	91-95		0,80	BR8ES	5422	05	BR8EIX	5044
500	2		500 Trail ES	88-89		0,70	BR9ES	5722	02	BR9EIX	3981
500	2		500 Trail SKS, 500 Trail SP	88-89		0,70	BR9ES	5722	02	BR9EIX	3981
500	2		500 Trail Supertrak	89-90		0,70	BR9ES	5722	02	BR9EIX	3981
500	2		500 Trail Supertrak	91		0,80	BR8ES	5422	05	BR8EIX	5044
500	2		500 Trail Touring	96-99		0,80	BR8ES	5422	05	BR8EIX	5044
500	2		500 Widetrack	90		0,70	BR9ES	5722	02	BR9EIX	3981
500	2		500 Widetrack	91-93		0,80	BR8ES	5422	05	BR8EIX	5044
500	2		500 Widetrack GT	93-97		0,80	BR8ES	5422	05	BR8EIX	5044
500	2		500 Widetrack LX	94-07		0,80	BR8ES	5422	05	BR8EIX	5044
500	2		500 Widetrack LX Euro	00		0,80	BR8ES	5422	05	BR8EIX	5044
500	2		500 Widetrack LX Euro	02		0,80	BR8ES	5422	05	BR8EIX	5044
500	2		500 XC	99-00		0,70	BR9ES	5722	02	BR9EIX	3981
500	2		500 XC	01-02		0,60	BR10EG	3830	-	-	-
500	2		500 XC Edge, 500 XC Edge F/O	03		0,60	BR10EG	3830	-	-	-
500	2		500 XC SP	99		0,70	BR9ES	5722	02	BR9EIX	3981
500	2		500 XC SP	00-07		0,60	BR10EG	3830	-	-	-
500	2		500 XC SP Edge	03		0,60	BR10EG	3830	-	-	-
500	2		500 XC SP Edge Stock B	06		0,60	BR10EG	3830	-	-	-
500	2		500 XC SP Edge M-10 F/O	03		0,60	BR10EG	3830	-	-	-
500	2		500 XC SP Edge X F/O	03		0,60	BR10EG	3830	-	-	-
500	2		500 XC SP Edge/M-10	04-05		0,60	BR10EG	3830	-	-	-
500	2		500 XC SP F/O	02		0,60	BR10EG	3830	-	-	-
550	2	INDY	550 Indy / ES / INTL, 550 Indy 144 / ES	14		0,70	BR9ES	5722	02	BR9EIX	3981
550	2	INDY	550 Indy Adventure / INTL, 550 Indy LXT	14		0,70	BR9ES	5722	02	BR9EIX	3981
550	2	INDY	550 Indy Voyager / INTL	14		0,70	BR9ES	5722	02	BR9EIX	3981
550	2	IQ	550 IQ LXT / INTL	11-13		0,70	BR9ES	5722	02	BR9EIX	3981

CYL.	Nb Cyl.	TYPE	MODÈLE		INFO			N° STOCK	N° BLISTER		N° STOCK IX
550	2	IQ	550 IQ Shift / ES / INTL	10-13		0,70	BR9ES	5722	02	BR9EIX	3981
550	2	IQ	550 IQ Shift / Euro	09		0,70	BR9ES	5722	02	BR9EIX	3981
550	2	RMK	Trail RMK	99		0,80	BR8ES	5422	05	BR8EIX	5044
550	2	RMK	Trail RMK	00-04		0,70	BR9ES	5722	02	BR9EIX	3981
550	2	RMK	Trail RMK	07		0,70	BR9ES	5722	02	BR9EIX	3981
550	2	RMK	Trail RMK / ES	10		0,70	BR9ES	5722	02	BR9EIX	3981
550	2	RMK	Trail RMK 136	02		0,70	BR9ES	5722	02	BR9EIX	3981
550	2	RMK	Trail RMK 136 F/O	05		0,70	BR9ES	5722	02	BR9EIX	3981
550	2	RMK	Trail RMK 136 Stock A	06		0,70	BR9ES	5722	02	BR9EIX	3981
550	2	RMK	Trail RMK/FLEET/ES/Euro	09		0,70	BR9ES	5722	02	BR9EIX	3981
550	2	RMK	Trail RMK/FLEET/Euro	08		0,70	BR9ES	5722	02	BR9EIX	3981
550	2	RMK	Trail Touring	00		0,70	BR9ES	5722	02	BR9EIX	3981
550	2	RMK	Trail Touring	03		0,70	BR9ES	5722	02	BR9EIX	3981
550	2	RMK	Trail Touring Deluxe	07		0,70	BR9ES	5722	02	BR9EIX	3981
550	2	RMK	Trail Touring/FLEET/Euro	08		0,70	BR9ES	5722	02	BR9EIX	3981
550	2	RMK	Trail Touring/FLEET/Transport/Euro	09		0,70	BR9ES	5722	02	BR9EIX	3981
550	2		550 Classic	05-06		0,70	BR9ES	5722	02	BR9EIX	3981
550	2		550 Classic Edge	03-04		0,70	BR9ES	5722	02	BR9EIX	3981
550	2		550 Edge LX	07		0,70	BR9ES	5722	02	BR9EIX	3981
550	2		550 F/C Classic	02		0,70	BR9ES	5722	02	BR9EIX	3981
550	2		550 LX	08		0,70	BR9ES	5722	02	BR9EIX	3981
550	2		550 Shift 136 / ES / CND ES / CND ES INTL	11-13		0,70	BR9ES	5722	02	BR9EIX	3981
550	2		Sport Touring	00-03		0,70	BR9ES	5722	02	BR9EIX	3981
550	2		Sport Touring ES	01		0,70	BR9ES	5722	02	BR9EIX	3981
550	2		Sport Touring ES Euro	02		0,70	BR9ES	5722	02	BR9EIX	3981
550	2		Sport Touring Euro	00-01		0,70	BR9ES	5722	02	BR9EIX	3981
550	2		Sport Touring/INT'L	04		0,70	BR9ES	5722	02	BR9EIX	3981
550	2		SuperSport	99		0,80	BR8ES	5422	05	BR8EIX	5044
550	2		SuperSport	00		0,70	BR9ES	5722	02	BR9EIX	3981
550	2		SuperSport	02		0,70	BR9ES	5722	02	BR9EIX	3981
550	2		SuperSport	05-06		0,70	BR9ES	5722	02	BR9EIX	3981
550	2		SuperSport Edge	01		0,70	BR9ES	5722	02	BR9EIX	3981
550	2		SuperSport Edge	03-04		0,70	BR9ES	5722	02	BR9EIX	3981
550	2		SuperSport Edge X F/O	03		0,70	BR9ES	5722	02	BR9EIX	3981
550	2		SuperSport/Euro	07-08		0,70	BR9ES	5722	02	BR9EIX	3981
550	2		SuperSport M-10 F/O, SuperSport M-10 X F/O	03		0,70	BR9ES	5722	02	BR9EIX	3981
550	2		Trail SKS Euro	99		0,80	BR8ES	5422	05	BR8EIX	5044
550	2		Trail Touring	02		0,70	BR9ES	5722	02	BR9EIX	3981
550	2		Trail Touring	06		0,70	BR9ES	5722	02	BR9EIX	3981
550	2		Trail Touring/Euro	05		0,70	BR9ES	5722	02	BR9EIX	3981
550	2		Trail Touring/INT'L	04		0,70	BR9ES	5722	02	BR9EIX	3981
550	2		Trail Touring/INTL/FLEET	10		0,70	BR9ES	5722	02	BR9EIX	3981
600	2	INDY	600 Indy / SP / ES / Intl All Options	13-14		0,70	BPR9ES	7788	-	BPR9EIX	6853
600	2	INDY	600 Indy Voyager / Intl	14		0,70	BPR9ES	7788	-	BPR9EIX	6853
600	2	IQ	600 / IQ LX / Euro All Options	08		0,60	BR10EG	3830	-	-	-
600	2	IQ	600 HO IQ F/O, 600 HO IQ/LX Cleanfire	07		0,60	BR10EG	3830	-	-	-
600	2	IQ	600 HO IQ Touring Cleanfire/Euro	07		0,60	BR10EG	3830	-	-	-
600	2	IQ	600 IQ LXT / INTL	11-14		0,60	BR10EG	3830	-	-	-
600	2	IQ	600 IQ Racer	10		0,60	BR10EG	3830	-	-	-
600	2	IQ	600 IQ Racer / INTL	11-14		0,60	BR10EG	3830	-	-	-
600	2	IQ	600 IQ Racer/Euro	08-09		0,60	BR10EG	3830	-	-	-
600	2	IQ	600 IQ Shift / ES / INTL	10-12		0,60	BR10EG	3830	-	-	-
600	2	IQ	600 IQ Shift / Euro	08-09		0,60	BR10EG	3830	-	-	-
600	2	IQ	600 IQ Shift 136/Euro	09		0,70	BPR9ES	7788	-	BPR9EIX	6853
600	2	IQ	600 IQ Touring / Euro	08-09		0,60	BR10EG	3830	-	-	-
600	2	IQ	600 IQ Touring / INTL	10		0,60	BR10EG	3830	-	-	-
600	2	IQ	600 IQ/ES/ES Euro	09		0,60	BR10EG	3830	-	-	-
600	2	IQ	600 Widetrack IQ / Intl	10-14		0,70	BPR9ES	7788	-	BPR9EIX	6853
600	2	RMK	600 HO RMK 144 F/O	06		0,60	BR10EG	3830	-	-	-
600	2	RMK	600 Pro RMK 155	12-14		0,70	BPR9ES	7788	-	BPR9EIX	6853
600	2	RMK	600 RMK	98-99		0,70	BR9ES	5722	02	BR9EIX	3981
600	2	RMK	600 RMK	00		0,60	BR10EG	3830	-	-	-
600	2	RMK	600 RMK / 144 / 155 / ES / INTL	10-11		0,60	BR10EG	3830	-	-	-
600	2	RMK	600 RMK 136	01-02		0,60	BR10EG	3830	-	-	-
600	2	RMK	600 RMK 144	03		0,60	BR10EG	3830	-	-	-
600	2	RMK	600 RMK 144/155	07		0,60	BR10EG	3830	-	-	-
600	2	RMK	600 RMK 144/155	14		0,70	BPR9ES	7788	-	BPR9EIX	6853
600	2	RMK	600 RMK 144/155 All Options	13		0,70	BPR9ES	7788	-	BPR9EIX	6853
600	2	RMK	600 RMK 144/ES/INTL/155/ES All Options	12		0,70	BPR9ES	7788	-	BPR9EIX	6853
600	2	RMK	600 RMK 144/Euro/RMK Shift/Euro	08		0,60	BR10EG	3830	-	-	-
600	2	RMK	600 RMK 155	08		0,60	BR10EG	3830	-	-	-
600	2	RMK	600 RMK F/O	04-05		0,60	BR10EG	3830	-	-	-
600	2	RMK	600 RMK Shift 144/155/Euro	09		0,70	BPR9ES	7788	-	BPR9EIX	6853
600	3	RMK	600 XLT RMK	95-97		0,80	BR8ES	5422	05	BR8EIX	5044
600	3		600 XLT	93-96		0,70	BR9ES	5722	02	BR9EIX	3981

CYL.	Nb Cyl.	TYPE	MODÈLE		INFO			N° STOCK	N° BLISTER		N° STOCK IX
600	3		600 XLT SKS	93		0,70	BR9ES	5722	02	BR9EIX	3981
600	3		600 XLT SKS	94-96		0,80	BR8ES	5422	05	BR8EIX	5044
600	3		600 XLT SP	92-93		0,70	BR9ES	5722	02	BR9EIX	3981
600	3		600 XLT SP	94-95		0,80	BR8ES	5422	05	BR8EIX	5044
600	3		600 XLT SP	96		0,70	BR9ES	5722	02	BR9EIX	3981
600	3		600 XLT SP 48" Stance	95		0,80	BR8ES	5422	05	BR8EIX	5044
600	3		600 XLT SP LT	95		0,80	BR8ES	5422	05	BR8EIX	5044
600	3		600 XLT SP XTRA	94		0,80	BR8ES	5422	05	BR8EIX	5044
600	3		600 XLT Touring	95-96		0,80	BR8ES	5422	05	BR8EIX	5044
600	2	RR	600 RR / Euro	08-09		0,60	BR10EG	3830	-	-	-
600	2	RUSH	600 Rush / ES	01-13		0,70	BPR9ES	7788	-	BPR9EIX	6853
600	2	RUSH	600 Rush Pro R/ ES / Intl	14		0,70	BPR9ES	7788	-	BPR9EIX	6853
600	2	RUSH	600 Rush Pro R/ ES / Intl / Retro	13		0,70	BPR9ES	7788	-	BPR9EIX	6853
600	2	RUSH	600 Rush Pro-R / ES / Retro All Options	11		0,70	BPR9ES	7788	-	BPR9EIX	6853
600	2	RUSH	600 Rush Pro-R / SC / SP / ES / INTL All Opt.	12		0,70	BPR9ES	7788	-	BPR9EIX	6853
600	2	RUSH	600 Rush/ES/Retro ES/LX/LX Retro All Opt.	11		0,70	BPR9ES	7788	-	BPR9EIX	6853
600	2	RUSH	600 Shift 136 / ES / INTL	11		0,60	BR10EG	3830	-	-	-
600	2		Switchback 600 Dragon Switchback All Options	10		0,60	BR10EG	3830	-	-	-
600	2		Switchback 600 Switchback / ES	11		0,60	BR10EG	3830	-	-	-
600	2		Switchback 600 Switchback / ES	12-14		0,70	BPR9ES	7788	-	BPR9EIX	6853
600	2		Switchback 600 Switchback Adventure	12-14		0,70	BPR9ES	7788	-	BPR9EIX	6853
600	2		Switchback 600 Switchback Assault All Options	14		0,70	BPR9ES	7788	-	BPR9EIX	6853
600	2		Switchback 600 Switchback F/O (S05NS6ES)	05		0,60	BR10EG	3830	-	-	-
600	2		Switchback 600 Switchback Pro R / ES / Intl	14		0,70	BPR9ES	7788	-	BPR9EIX	6853
600	2		Switchback 600 Switchback Pro R / ES / Intl / Retro	13		0,70	BPR9ES	7788	-	BPR9EIX	6853
600	2		Switchback 600 Switchback Pro-R	12		0,70	BPR9ES	7788	-	BPR9EIX	6853
600	2		Switchback 600 Switchback/Dragon Switchback All Opt.	08		0,60	BR10EG	3830	-	-	-
600	2		Switchback 600 Switchback/Dragon/Euro	09		0,60	BR10EG	3830	-	-	-
600	2		Switchback 600 Switchback/ES/INTL/LX/INTL All Options	10		0,60	BR10EG	3830	-	-	-
600	2		Switchback 600 Cleanfire Switchback	07		0,60	BR10EG	3830	-	-	-
600	2		Switchback 600 HO Switchback F/O	06-07		0,60	BR10EG	3830	-	-	-
600	2		Switchback 600 Switchback	04		0,60	BR10EG	3830	-	-	-
600	2		600 Classic	02-06		0,60	BR10EG	3830	-	-	-
600	2		600 Classic Edge	01		0,60	BR10EG	3830	-	-	-
600	2		600 Classic Touring	01-03		0,60	BR10EG	3830	-	-	-
600	2		600 Classic Touring/INT'L	04		0,60	BR10EG	3830	-	-	-
600	2		600 Dragon SP/ES Euro	09		0,60	BR10EG	3830	-	-	-
600	2		600 Edge Touring	05-06		0,60	BR10EG	3830	-	-	-
600	2		600 HO Fusion F/O	06		0,60	BR10EG	3830	-	-	-
600	2		600 Pro X	01-03		0,60	BR10EG	3830	-	-	-
600	2		600 Pro X/Pro X2	04		0,60	BR10EG	3830	-	-	-
600	2		600 Touring	00		0,60	BR10EG	3830	-	-	-
600	2		600 Triumph	00		0,70	BR9ES	5722	02	BR9EIX	3981
600	2		600 XC (Twin)	96		0,70	BR9ES	5722	02	BR9EIX	3981
600	3		600 XC	97-99		0,70	BR9ES	5722	02	BR9EIX	3981
600	2		600 XC Deluxe	00		0,60	BR10EG	3830	-	-	-
600	2		600 XC Edge F/O	03		0,60	BR10EG	3830	-	-	-
600	2		600 XC SP	99		0,70	BR9ES	5722	02	BR9EIX	3981
600	2		600 XC SP	01-02		0,60	BR10EG	3830	-	-	-
600	2		600 XC SP Edge	00		0,60	BR10EG	3830	-	-	-
600	2		600 XC SP Edge	03		0,60	BR10EG	3830	-	-	-
600	2		600 XC SP Edge M-10 F/O	03		0,60	BR10EG	3830	-	-	-
600	2		600 XC SP Edge X F/O	03		0,60	BR10EG	3830	-	-	-
600	2		600 XC SP Edge/M-10	04-05		0,60	BR10EG	3830	-	-	-
600	2		600 XC SP (EV)	00		0,60	BR10EG	3830	-	-	-
600	2		600 XC SP F/O	02		0,60	BR10EG	3830	-	-	-
600	2		600 XC SP M-10 F/O	02		0,60	BR10EG	3830	-	-	-
600	3		600 XCR	94-98		0,70	BR9ES	5722	02	BR9EIX	3981
600	3		600 XCR SE	97		0,70	BR9ES	5722	02	BR9EIX	3981
600	3		600 XLT, 600 XLT SKS	97		0,80	BR8ES	5422	05	BR8EIX	5044
600	3		600 XLT Classic	98		0,70	BR9ES	5722	02	BR9EIX	3981
600	3		600 XLT Classic	99		0,80	BR8ES	5422	05	BR8EIX	5044
600	3		600 XLT LTD	97-98		0,80	BR8ES	5422	05	BR8EIX	5044
600	3		600 XLT LTD SP	97		0,70	BR9ES	5722	02	BR9EIX	3981
600	3		600 XLT SP	97		0,80	BR8ES	5422	05	BR8EIX	5044
600	3		600 XLT SP	98-99		0,70	BR9ES	5722	02	BR9EIX	3981
600	3		600 XLT Touring	97-99		0,80	BR8ES	5422	05	BR8EIX	5044
650	3		650	88-92		0,70	BR9ES	5722	02	BR9EIX	3981
650	3		650 RXL	90-97		0,70	BR9ES	5722	02	BR9EIX	3981
650	3		650 RXL LT	95		0,70	BR9ES	5722	02	BR9EIX	3981
650	3		650 RXL SKS	91-93		0,70	BR9ES	5722	02	BR9EIX	3981
650	3		650 RXL Touring	94-95		0,70	BR9ES	5722	02	BR9EIX	3981
650	3		650 SKS	88-90		0,70	BR9ES	5722	02	BR9EIX	3981
700	2	IQ	700 IQ / Dragon	08		0,60	BR10EG	3830	-	-	-
700	2	RMK	700 RMK	97-99		0,70	BR9ES	5722	02	BR9EIX	3981

CYL.	Nb Cyl.	TYPE	MODÈLE		INFO			N° STOCK	N° BLISTER		N° STOCK IX
700	2	RMK	700 RMK	00		0,60	BR10EG	3830	-	-	-
700	2	RMK	700 RMK	06		0,60	BR10EG	3830	-	-	-
700	2	RMK	700 RMK 136	01-02		0,60	BR10EG	3830	-	-	-
700	2	RMK	700 RMK 136 Stock	02		0,60	BR10EG	3830	-	-	-
700	2	RMK	700 RMK 144	01		0,60	BR10EG	3830	-	-	-
700	2	RMK	700 RMK 144 F/O, 700 RMK 144 Stock	02-03		0,60	BR10EG	3830	-	-	-
700	2	RMK	700 RMK 151 F/O	02-03		0,60	BR10EG	3830	-	-	-
700	2	RMK	700 RMK 151 Stock	03		0,60	BR10EG	3830	-	-	-
700	2	RMK	700 RMK 155/163 All Options	08		0,60	BR10EG	3830	-	-	-
700	2	RMK	700 RMK 155/ES	09		0,60	BR10EG	3830	-	-	-
700	2	RMK	700 RMK Early ProD	08		0,60	BR10EG	3830	-	-	-
700	2	RMK	700 RMK F/O	04-05		0,60	BR10EG	3830	-	-	-
700	2	Switchback	700 Switchback/Dragon Switchback All Opt.	08		0,60	BR10EG	3830	-	-	-
700	2	Switchback	700 Switchback	04		0,60	BR10EG	3830	-	-	-
700	2		700 Classic	01-05		0,60	BR10EG	3830	-	-	-
700	2		700 Classic Touring	03		0,60	BR10EG	3830	-	-	-
700	2		700 Classic Touring/INT'L	04		0,60	BR10EG	3830	-	-	-
700	2		700 Cleanfire Dragon/Euro	07		0,60	BR10EG	3830	-	-	-
700	2		700 Fusion F/O, 700 HO Touring	06		0,60	BR10EG	3830	-	-	-
700	2		700 Pro X	03		0,60	BR10EG	3830	-	-	-
700	2		700 Pro X/Pro X2	04		0,60	BR10EG	3830	-	-	-
700	2		700 SKS	00-03		0,60	BR10EG	3830	-	-	-
700	2		700 SKS Euro	02		0,60	BR10EG	3830	-	-	-
700	2		700 SKS	97		0,70	BR9ES	5722	02	BR9EIX	3981
700	2		700 SKS	99		0,70	BR9ES	5722	02	BR9EIX	3981
700	3		700 Ultra	97-98		0,70	BR9ES	5722	02	BR9EIX	3981
700	3	RMK	700 Ultra RMK	96		0,70	BR9ES	5722	02	BR9EIX	3981
700	3		700 Ultra SKS	96		0,70	BR9ES	5722	02	BR9EIX	3981
700	3		700 Ultra SP	96-97		0,70	BR9ES	5722	02	BR9EIX	3981
700	3		700 Ultra Touring	97-98		0,70	BR9ES	5722	02	BR9EIX	3981
700	2		700 XC	97-99		0,70	BR9ES	5722	02	BR9EIX	3981
700	2		700 XC Deluxe	00		0,60	BR10EG	3830	-	-	-
700	2		700 XC Edge F/O	03-04		0,60	BR10EG	3830	-	-	-
700	2		700 XC SP	99		0,70	BR9ES	5722	02	BR9EIX	3981
700	2		700 XC SP	00-02		0,60	BR10EG	3830	-	-	-
700	2		700 XC SP Edge	03		0,60	BR10EG	3830	-	-	-
700	2		700 XC SP Edge EV	01		0,60	BR10EG	3830	-	-	-
700	2		700 XC SP Edge M-10 F/O / Edge X F/O	03		0,60	BR10EG	3830	-	-	-
700	2		700 XC SP F/O, 700 XC SP M-10 F/O	02		0,60	BR10EG	3830	-	-	-
700	2		700 XC SP M-10 F/O	05		0,60	BR10EG	3830	-	-	-
700	3		700 XCR	98		0,70	BR9ES	5722	02	BR9EIX	3981
700	3		700 XCR (099AB7BS)	99		0,70	BR9ES	5722	02	BR9EIX	3981
750	2	IQ	FS IQ Touring/Euro	07-09		0,70	BKR7E	6097	-	BKR7EIX	2667
750	2	IQ	FST IQ Touring	07		0,90	PFR7G-9	4371	-	-	-
800	2	INDY	800 Indy SP / ES / Intl All Options	14		0,70	BPR9ES	7788	-	BPR9EIX	6853
800	2	IQ	800 Dragon IQ/ES/INTL All Options	10		0,60	BR10EG	3830	-	-	-
800	2	IQ	800 IQ / ES	09-10		0,60	BR10EG	3830	-	-	-
800	2	RMK	800 Dragon RMK 155 Special Late ProD	08		0,60	BR10EG	3830	-	-	-
800	2	RMK	800 Dragon RMK 155/163 All Options	10		0,60	BR10EG	3830	-	-	-
800	2	RMK	800 Dragon RMK 155/163/ES/Euro All Options	09		0,60	BR10EG	3830	-	-	-
800	2	RMK	800 Dragon RMK 155/163/Euro	08		0,60	BR10EG	3830	-	-	-
800	2	RMK	800 Pro RMK / 155 / 163 All Options	12-13		0,70	BPR9ES	7788	-	BPR9EIX	6853
800	2	RMK	800 Pro RMK / LE 155 / 163 All Options	14		0,70	BPR9ES	7788	-	BPR9EIX	6853
800	2	RMK	800 Pro RMK 155/163/ES/INTL All Options	11		0,70	BPR9ES	7788	-	BPR9EIX	6853
800	2	RMK	800 RMK	00		0,60	BR10EG	3830	-	-	-
800	2	RMK	800 RMK 144	01		0,60	BR10EG	3830	-	-	-
800	2	RMK	800 RMK 144 F/O	02-03		0,60	BR10EG	3830	-	-	-
800	2	RMK	800 RMK 144 F/O Stock	02		0,60	BR10EG	3830	-	-	-
800	2	RMK	800 RMK 144 Stock	03		0,60	BR10EG	3830	-	-	-
800	2	RMK	800 RMK 144 / 155 / ES / INTL	10		0,60	BR10EG	3830	-	-	-
800	2	RMK	800 RMK 151	01		0,60	BR10EG	3830	-	-	-
800	2	RMK	800 RMK 151 F/O, 800 RMK 151 Stock	02-03		0,60	BR10EG	3830	-	-	-
800	2	RMK	800 RMK 155	14		0,70	BPR9ES	7788	-	BPR9EIX	6853
800	2	RMK	800 RMK 155/ES/INTL	11-13		0,70	BPR9ES	7788	-	BPR9EIX	6853
800	2	RMK	800 RMK 156 F/O	02-03		0,60	BR10EG	3830	-	-	-
800	2	RMK	800 RMK 159 Vertical Escape	03		0,60	BR10EG	3830	-	-	-
800	2	RMK	800 RMK Assault / INTL	10		0,60	BR10EG	3830	-	-	-
800	2	RMK	800 RMK Assault 146	09		0,60	BR10EG	3830	-	-	-
800	2	RMK	800 RMK Assault 155 All Options	12		0,70	BPR9ES	7788	-	BPR9EIX	6853
800	2	RMK	800 RMK Assault 155/ INTL	11		0,70	BPR9ES	7788	-	BPR9EIX	6853
800	2	RMK	800 RMK Assault All Options	13-14		0,70	BPR9ES	7788	-	BPR9EIX	6853
800	2	RMK	800 RMK F/O	04-05		0,60	BR10EG	3830	-	-	-
800	2	RMK	800 RMK Shift 144	09		0,60	BR10EG	3830	-	-	-
800	2	RMK	800 RMK SP 144, 800 RMK SP 151	01		0,60	BR10EG	3830	-	-	-
800	2	RMK	800 Rush / ES	09		0,60	BR10EG	3830	-	-	-

CYL.	Nb Cyl.	TYPE	MODÈLE		INFO			N° STOCK	N° BLISTER		N° STOCK IX
800	2	RUSH	800 Rush / ES	12-13		0,70	BPR9ES	7788	-	BPR9EIX	6853
800	2	RUSH	800 Rush Pro R All Options	14		0,70	BPR9ES	7788	-	BPR9EIX	6853
800	2	RUSH	800 Rush Pro R All Options	12-13		0,70	BPR9ES	7788	-	BPR9EIX	6853
800	2	RUSH	800 Rush Pro-R/ES/Retro All Options	11		0,70	BPR9ES	7788	-	BPR9EIX	6853
800	2	RUSH	800 Rush/ES/Retro/Retro LX/Retro ES All Opt.	11		0,70	BPR9ES	7788	-	BPR9EIX	6853
800	3		800 Storm	93-94		0,70	BR9ES	5722	02	BR9EIX	3981
800	3		800 Storm	95		0,80	BR8ES	5422	05	BR8EIX	5044
800	3		800 Storm	96		0,70	BR9ES	5722	02	BR9EIX	3981
800	3	RMK	800 Storm RMK	96		0,70	BR9ES	5722	02	BR9EIX	3981
800	3		800 Storm SKS	93-94		0,70	BR9ES	5722	02	BR9EIX	3981
800	3		800 Storm SKS	95		0,80	BR8ES	5422	05	BR8EIX	5044
800	3		800 Storm SKS	96		0,70	BR9ES	5722	02	BR9EIX	3981
800	3		800 Storm SKS PDL TRK	95		0,80	BR8ES	5422	05	BR8EIX	5044
800	3		800 Storm	97-98		0,70	BR9ES	5722	02	BR9EIX	3981
800	3	RMK	800 Storm RMK	97		0,70	BR9ES	5722	02	BR9EIX	3981
800	3		800 Storm SE	97		0,70	BR9ES	5722	02	BR9EIX	3981
800	2		Switchback 800 Dragon Switchback/ES/INTL All Options	10		0,60	BR10EG	3830	-	-	-
800	2		Switchback 800 Switchback	04		0,60	BR10EG	3830	-	-	-
800	2		Switchback 800 Switchback Adventure	14		0,70	BPR9ES	7788	-	BPR9EIX	6853
800	2		Switchback 800 Switchback Assault All Options	12-14		0,70	BPR9ES	7788	-	BPR9EIX	6853
800	2		Switchback 800 Switchback Assault/INTL	11		0,70	BPR9ES	7788	-	BPR9EIX	6853
800	2		Switchback 800 Switchback F/O	05		0,60	BR10EG	3830	-	-	-
800	2		Switchback 800 Switchback Pro R/ES/INT/LE All Options	14		0,70	BPR9ES	7788	-	BPR9EIX	6853
800	2		Switchback 800 Switchback Pro-R/ES/INTL/Retro/LE	13		0,70	BPR9ES	7788	-	BPR9EIX	6853
800	2		Switchback 800 Switchback Pro-R/ES/SC/SP/INTL	12		0,70	BPR9ES	7788	-	BPR9EIX	6853
800	2		Switchback 800 Switchback/Dragon/Euro	09		0,60	BR10EG	3830	-	-	-
800	2		Switchback 800 Switchback/ES	10		0,60	BR10EG	3830	-	-	-
800	2		Switchback 800 Switchback/ES	12-14		0,70	BPR9ES	7788	-	BPR9EIX	6853
800	2		800 Classic	04		0,60	BR10EG	3830	-	-	-
800	2		800 Classic Touring	03		0,60	BR10EG	3830	-	-	-
800	2		800 Classic Touring/INT'L	04		0,60	BR10EG	3830	-	-	-
800	2		800 Dragon SP/ES Euro	09		0,60	BR10EG	3830	-	-	-
800	2		800 Edge Touring	05		0,60	BR10EG	3830	-	-	-
800	2		800 LE	01		0,60	BR10EG	3830	-	-	-
800	2		800 Pro X	03		0,60	BR10EG	3830	-	-	-
800	2		800 Pro X/Pro X2, 800 Pro XR	04		0,60	BR10EG	3830	-	-	-
800	2		800 SKS	03		0,60	BR10EG	3830	-	-	-
800	2		800 XC Edge F/O	03-04		0,60	BR10EG	3830	-	-	-
800	2		800 XC SP	01		0,60	BR10EG	3830	-	-	-
800	2		800 XC SP Edge	03		0,60	BR10EG	3830	-	-	-
800	2		800 XC SP Edge M-10 F/O / Edge X F/O	03		0,60	BR10EG	3830	-	-	-
800	2		800 XC SP F/O / SP M-10 F/O	02		0,60	BR10EG	3830	-	-	-
800	2		800 XC SP M-10 F/O	05		0,60	BR10EG	3830	-	-	-
800	2		800 XC SP Stock	02		0,60	BR10EG	3830	-	-	-
800	3		800 XCR	99-03		0,70	BR9ES	5722	02	BR9EIX	3981
900	2	RMK	900 RMK	06		0,60	BR10EG	3830	-	-	-
900	2	RMK	900 RMK All Options	05		0,60	BR10EG	3830	-	-	-
900	2		Switchback 900 Switchback	05-06		0,60	BR10EG	3830	-	-	-
900	2		900 Fusion	05		0,60	BR10EG	3830	-	-	-
900	2		900 Fusion F/O	06		0,60	BR10EG	3830	-	-	-
-	2	INDY	Indy Frontier	02		0,70	BKR7E	6097	-	BKR7EIX	2667
-	2	IQ	FST IQ Cruiser / IQ LX / IQ Switchback	07		0,90	PFR7G-9	4371	-	-	-
-	2	RMK	Dragon RMK/INTL	07		0,60	BR10EG	3830	-	-	-
-	2		Switchback FST Switchback	06		0,90	PFR7G-9	4371	-	-	-
-	2		Frontier Classic	04		0,70	BKR7E	6097	-	BKR7EIX	2667
-	2		Frontier Touring	03-05		0,70	BKR7E	6097	-	BKR7EIX	2667
-	2		FS Classic, FS Touring	06		0,70	BKR7E	6097	-	BKR7EIX	2667
-	2		FST Classic, FST Touring	06		0,90	PFR7G-9	4371	-	-	-
-	2		Widetrack LX	10		0,80	BR8ES	5422	05	BR8EIX	5044
-	2		Widetrack LX / Euro	08-09		0,80	BR8ES	5422	05	BR8EIX	5044
-	2		Widetrack LX / INTL	11-14		0,80	BR8ES	5422	05	BR8EIX	5044



POLINI

50	1	Steel	910 LC - pocket bike	-		0,60	B6HS	4510	09	BR6HIX	3419
50	1	Steel	910 Race / LC Race - pocket bike	-		0,60	-	-	-	BR7HIX	7067



REGAL RAPTOR

50	1		DD50QE-2	03-		0,70	CR7HSA	4549	07	CR7HIX	7544
100			DD100E	03-		0,70	CR7HSA	4549	07	CR7HIX	7544



RENAULT Sport

50	1	Campus	01-	0,60	BR8ES	5422	05	BR8EIX	5044
50	1	Spécimen	01-	0,60	BR8HS	4322	01	BR8HIX	7001
100	1	Spécimen	01-	0,60	BR8HS	4322	01	BR8HIX	7001
125	1	Kouranos, Fulltime, Groomy	01-	0,70	CR9EB	6955	06	CR9EIX	3521



RFR

138		Moteur Linhai	07-	0,70	C7HSA	4629	07	CR7HIX	7544
-----	--	---------------	-----	------	-------	------	----	--------	------



RIEJU

50	1	Drac	96-	0,50	BR8ES	5422	05	BR8EIX	5044
50		Tango	07-	0,70	BR9ES	5722	02	BR9EIX	3981
50	1	Windy	-	0,50	BR7HS	4122	03	BR7HIX	7067
50		MRT MRT 50 (Incl. Pro, SM)	-	0,60	BR9ES	5722	02	BR9EIX	3981
50	1	MRX Euro	02-	0,60	BR9ES	5722	02	BR9EIX	3981
50	1	MRX Top	03-	0,60	BR9ES	5722	02	BR9EIX	3981
50	1	MX Infantil - Morini S5	01	0,50	B6HS	4510	09	BR6HIX	3419
50	1	MX Infantil - Morini S6	02-	0,60	BR9ES	5722	02	BR9EIX	3981
50	1	NKD	03-	0,60	BR9ES	5722	02	BR9EIX	3981
50	1	RR	-	0,70	BR8ES	5422	05	BR8EIX	5044
50	1	RR Castrol, Euro	02-	0,60	BR9ES	5722	02	BR9EIX	3981
50	1	RR Racing, Spike	-00	0,70	BR8ES	5422	05	BR8EIX	5044
50	1	RR Spike Racing Pro	01-	0,70	BR8ES	5422	05	BR8EIX	5044
50	1	RR Supermotard	-00	0,70	BR8ES	5422	05	BR8EIX	5044
50		RRX Spike 50 Supermoto	07-	0,50	BR8ES	5422	05	BR8EIX	5044
50	1	RS1	97-	0,60	BR8ES	5422	05	BR8EIX	5044
50		RS1 Evo	98-04	0,80	BR9ES	5722	02	BR9EIX	3981
50	1	RS1 Evo Euro	02-	0,60	BR9ES	5722	02	BR9EIX	3981
50	1	RS1 Racing	97-00	0,70	BR8ES	5422	05	BR8EIX	5044
50		RS2 Matrix (Incl. Pro)	03-	0,70	BR9ES	5722	02	BR9EIX	3981
50		RS2 NKD	-	0,70	BR9ES	5722	02	BR9EIX	3981
50		RS3	11-	0,70	BR9ES	5722	02	BR9EIX	3981
50		RS3 NKD	13-	0,70	BR9ES	5722	02	BR9EIX	3981
50	1	SMX	02-	0,60	BR9ES	5722	02	BR9EIX	3981
125		Marathon (Endura / SM)	-	0,70	CR8E	1275	04	CR8EIX	4218
125		Tango	07-	0,60	CR7HSA	4549	07	CR7HIX	7544
125	1	MRX Moteur Yamaha	02-	0,60	CR7HSA	4549	07	CR7HIX	7544
125	1	SMX Moteur Yamaha	02-	0,60	CR7HSA	4549	07	CR7HIX	7544
125	1	RS2 Matrix	07-	0,60	CR7HSA	4549	07	CR7HIX	7544
125		RS2 NKD	06-07	0,60	CR7HSA	4549	07	CR7HIX	7544
125	1	RS3	11-	0,70	CR8E	1275	04	CR8EIX	4218
125	1	RS3 NKD	13-	0,70	CR8E	1275	04	CR8EIX	4218
250		Marathon	10-	0,70	CR8E	1275	04	CR8EIX	4218
250		Tango	-	0,70	D8EA	2120	11	DR8EIX	6681
450		Marathon	10-	0,70	CR8E	1275	04	CR8EIX	4218



ROYAL ENFIELD

50	1	Sunny, Bonny	-	0,50	B6HS	4510	09	BR6HIX	3419
100		KB 100	-	0,50	B8ES	2411	05	BR8EIX	5044
125		Scooter	-	0,50	B6HS	4510	09	BR6HIX	3419
350		Bullet & De Luxe - culot court	-	0,60	BR6HS	3922	09	BR6HIX	3419
350		Bullet & De Luxe - culot long	-	0,60	BR6ES	4922	-	-	-
500		Bullet Classic models	80-08	0,50	BR8ES	5422	05	BR8EIX	5044
500		Bullet - culot court	-	0,60	B8HS	5510	01	BR8HIX	7001
500		Bullet - culot long	-	0,60	B8ES	2411	05	BR8EIX	5044
500		Bullet Electra X	04-	0,80	BR9ES	5722	02	BR9EIX	3981



RTX





125	1	C 125, T 125	-	0,50	B7HS	5110	03	BR7HIX	7067
212	1	C 212, T 212	-	0,50	B8HS	5510	01	BR8HIX	7001



SACHS

50	1	4 rock	06-	0,70	BPR7HS	6422	14	BPR7HIX	5944
50	1	49er	05-	0,50	CR7HSA	4549	07	CR7HIX	7544

SACHS

CYL.	Nb Cyl.	TYPE	MODÈLE		INFO			N° STOCK	N° BLISTER		N° STOCK IX
50	1		Bee 50	-		0,60	BPR6HS	7022	-	BPR6HIX	4085
50	1		Buxy (RS)	-		0,60	B7HS	5110	03	BR7HIX	7067
50	1		City Roller CV 50	-		0,70	BPR6HS	7022	-	BPR6HIX	4085
50			Dirty Devil	04-		0,60	BP5HS	4111	-	-	-
50	1		Eagle	09-		0,60	BR8HSA	5539	-	BR8HIX	7001
50	1		Limbo	-		0,70	BP6HS	4511	-	BPR6HIX	4085
50			MadAss	04-		0,60	CR7HSA	4549	07	CR7HIX	7544
50	1		Reggae (RS)	-		0,60	B7HS	5110	03	BR7HIX	7067
50	1		Samba SR	-		0,50	B8HS	5510	01	BR8HIX	7001
50	1		Speedake	-		0,60	B7HS	5110	03	BR7HIX	7067
50	1		Speedfight 50 AC / 50 LC / 50 LC ADT	97-		0,60	BR7HS	4122	03	BR7HIX	7067
50	1		Speedforce 25 / 50 / R50	07-		0,60	BPR6HS	7022	-	BPR6HIX	4085
50	1		Speedjet 25 / 50	-		0,60	BPR6HS	7022	-	BPR6HIX	4085
50			Speedjet R	09-		0,70	BPR7HS	6422	14	BPR7HIX	5944
50			Speedjet RS	11-		0,70	BPR7HS	6422	14	BPR7HIX	5944
50	1		Splinter	-		0,60	B7HS	5110	03	BR7HIX	7067
50	1		Squab	-		0,60	BR8HS	4322	01	BR8HIX	7001
50	1		SR 50, SV 50, SV 50 Junior	-		0,60	B8HS	5510	01	BR8HIX	7001
50	1		SX1	-		0,60	BPR6HS	7022	-	BPR6HIX	4085
50	1		T-Rex	06-		0,60	BPR7HS	6422	14	BPR7HIX	5944
50	1		Zenith	-		0,60	BP6HS	4511	-	BPR6HIX	4085
80	1		City Roller CV 80	-		0,70	BPR6HS	7022	-	BPR6HIX	4085
80	1		City Roller CV 80 E	-		0,70	BR8HS	4322	01	BR8HIX	7001
80	1		SR 80, SV 80	-		0,60	B8HS	5510	01	BR8HIX	7001
100			Helix, T-Rex	06-		0,60	BPR7HS	6422	14	BPR7HIX	5944
110			4 rock	06-		0,70	BPR7HS	6422	14	BPR7HIX	5944
110	1		Dirty Devil	04-		0,60	C7HSA	4629	07	CR7HIX	7544
125	1		Eagle	09-		0,60	CR7HSA	4549	07	CR7HIX	7544
125			MadAss	06-		0,60	C7HSA	4629	07	CR7HIX	7544
125	1		SR 125, SR 125 C	-		0,60	BP6HS	4511	-	BPR6HIX	4085
125	1		Superduke	97-		0,60	C7HSA	4629	07	CR7HIX	7544
125	1		SV 125, SV 125 C	-		0,60	BP6HS	4511	-	BPR6HIX	4085
125	1	V2	Roadster	01-		0,70	CR6HSA	2983	-	CR6HIX	7274
125	1	XTC	Racing / N	01-		0,70	BR8ES	5422	05	BR8EIX	5044
125	1	ZX	Trail	01-		0,70	BR8ES	5422	05	BR8EIX	5044
125	1	ZZ	Super Motard	01-		0,70	BR8ES	5422	05	BR8EIX	5044
150			4 rock	06-		0,70	C7HSA	4629	07	CR7HIX	7544
150			Helix	06-		0,60	C7HSA	4629	07	CR7HIX	7544
250			4 rock	06-		0,70	CR8HSA	2086	-	CR8HIX	7669
650	1	V 1.6	Roadster	00-		0,70	CR10E	6264	-	CR10EIX	6482
800	2	V 3.8	Roadster	01-		0,90	DPR8EA-9	4929	08	DPR8EIX-9	2202
805			B 805	02-		0,90	DPR8EA-9	4929	08	DPR8EIX-9	2202



SACHS-Quad

50	1		4rock 50	06-		0,70	BPR7HS	6422	14	BPR7HIX	5944
50	1		Little Devil	-		0,60	BP6HS	4511	-	BPR6HIX	4085
50	1		T-Rex 50	06-		0,60	BPR7HS	6422	14	BPR7HIX	5944
100	1		Helix 100, T-Rex 100	06-		0,60	BPR7HS	6422	14	BPR7HIX	5944
110	1		4rock 110	06-		0,70	BPR7HS	6422	14	BPR7HIX	5944
150	1		4rock 150	06-		0,70	C7HSA	4629	07	CR7HIX	7544
150	1		Helix 150	06-		0,60	C7HSA	4629	07	CR7HIX	7544
250	1		4rock 250	06-		0,70	CR8HS	7423	-	-	-







SAN YANG

50	1		Bullet (G5A,B), DD, DD 50 Mofa	-		0,60	BR8HSA	5539	-	BR8HIX	7001
50	1		Dio (F5A, B, E)	-		0,60	BR8HSA	5539	-	BR8HIX	7001
50	1		Fancy 50	95-		0,60	BR8HSA	5539	-	BR8HIX	7001
50	1		Flash, Free, Jet / Euro X / Moi, Mike, Pure	-		0,60	BR8HSA	5539	-	BR8HIX	7001
50	1		Red Devil, RS 50 (Shark 50), Super Fancy 50	-		0,60	BR8HSA	5539	-	BR8HIX	7001
125	1		Duke 125	-		0,60	C7HSA	4629	07	CR7HIX	7544
125	1		Euro MX 125	-		0,60	CR7HSA	4549	07	CR7HIX	7544
125	1		GTS, HD 125 Evo	-		0,70	CR8E	1275	04	CR8EIX	4218
125	1		Joyride, RS 4V	-		0,60	CR7HSA	4549	07	CR7HIX	7544
125	1		Super Duke 125	-		0,60	C7HSA	4629	07	CR7HIX	7544
200	1		HD 200 i	-		0,70	CR8E	1275	04	CR8EIX	4218
250	1		GTS	-		0,70	CR8E	1275	04	CR8EIX	4218



SCORPA

70	1		4-Tricks	06-07		0,60	CR7HSA	4549	07	CR7HIX	7544
125	1	SR	R	11-		0,60	BP5ES	6511	-	BPR5EIX	6597

CYL.	Nb Cyl.	TYPE	MODÈLE		INFO			N° STOCK	N° BLISTER		N° STOCK IX	
125	1	SY	FR		03-09		0,60	CR7HSA	4549	07	CR7HIX	7544
125	1	TY-S	F		04-06		0,60	CR7HSA	4549	07	CR7HIX	7544
125		TY	F		12-		0,70	CR6HSA	2983	-	CR6HIX	7274
175	1	SY	FR		03-09		0,60	CR7HSA	4549	07	CR7HIX	7544
175	1	TY-S	F		03-09		0,60	CR7HSA	4549	07	CR7HIX	7544
250	1		Easy Trial		94-		0,60	BP5ES	6511	-	BPR5EIX	6597
250		SY	FR		07-		0,70	CR8E	1275	04	CR8EIX	4218
250	1	SY	Long Ride		00-		0,60	-	-	-	BPR6EIX	6637
250	1	SY	F Long Rider		07-		0,80	CR8E	1275	04	CR8EIX	4218
250			SY 250 Racing		01-09		0,60	-	-	-	BKR5EIX	6341
250	1	T	Ride F		08-		0,80	CR8E	1275	04	CR8EIX	4218
250		TY	250 / E		-		0,70	-	-	-	BKR6EIX	6418
272		SR	280R		11-		0,50	BP5ES	6511	-	BPR5EIX	6597
280	1		Easy Trial		94-		0,60	BP5ES	6511	-	BPR5EIX	6597
280	1	SR	R		11-		0,60	BP5ES	6511	-	BPR5EIX	6597
300	1		294, 295		11-		0,60	BP5ES	6511	-	BPR5EIX	6597



SHERCO

50			0.5 Kid		03-		0,60	B9ES	2611	02	BR9EIX	3981
50			Base, Champion Replica 50		-		0,70	BR9ES	5722	02	BR9EIX	3981
50	1		Enduro 50, HRD50		03-		0,70	BR9ES	5722	02	BR9EIX	3981
50			Ipone Replica		-		0,70	BR9ES	5722	02	BR9EIX	3981
50	1		Trial Kid		01-		0,50	B9ES	2611	02	BR9EIX	3981
50	1		SE-R, SM-R		14-		0,70	BR9ES	5722	02	BR9EIX	3981
50	1		Supermotard 50		03-		0,70	BR9ES	5722	02	BR9EIX	3981
75	1				08-		0,70	BP5ES	6511	-	BPR5EIX	6597
80	1		0.8		-		0,50	BP5ES	6511	-	BPR5EIX	6597
80	1		ST		14-		0,60	BP5ES	6511	-	BPR5EIX	6597
125	1				08-		0,70	BP5ES	6511	-	BPR5EIX	6597
125			Academy		09		0,60	BP5ES	6511	-	BPR5EIX	6597
125	1	ST	1.25 Moteur 2 temps		99-		0,60	BP5ES	6511	-	BPR5EIX	6597
125	1		1.2 Trial		00-		0,50	BP5ES	6511	-	BPR5EIX	6597
125	1		City Corp 125		04-		0,60	CR7HSA	4549	07	CR7HIX	7544
125	1		ST		14-		0,60	BP5ES	6511	-	BPR5EIX	6597
125	1		X-Ride		14-		0,60	BPR5ES	7422	-	BPR5EIX	6597
200	1		2.0		99-		0,50	BP5ES	6511	-	BPR5EIX	6597
250			Access 2.5 2T		10		0,60	BP5ES	6511	-	BPR5EIX	6597
250	1		Scottish Six Days Winner		99-		0,50	BP5ES	6511	-	BPR5EIX	6597
250			2.5i-F		08-11		0,70	CR8EK	3478	-	CR8EIX	4218
250	1		2.5 Trial		00-		0,50	BP5ES	6511	-	BPR5EIX	6597
250	1		SE 2 Temps, SE-R 2 Temps		14-		0,60	BR8ES	5422	05	BR8EIX	5044
250	1		SEF 4 Temps, SEF-R 4 Temps		14-		0,70	CR8EK	3478	-	CR8EIX	4218
250		SE	250i		12-		0,70	CR8EK	3478	-	CR8EIX	4218
250	1		ST		14-		0,60	BP5ES	6511	-	BPR5EIX	6597
250		ST	2.5		99-		0,60	BP5ES	6511	-	BPR5EIX	6597
290	1		ST, X-Ride		14-		0,60	BP5ES	6511	-	BPR5EIX	6597
290			3.0i-F		10-11		0,70	CR8EK	3478	-	CR8EIX	4218
290			Access 2.9 (2T)		10		0,60	BP5ES	6511	-	BPR5EIX	6597
290		ST	2.9		99-		0,60	BP5ES	6511	-	BPR5EIX	6597
290		SE	300i		12-		0,70	CR8EK	3478	-	CR8EIX	4218
300	1		SE 2 Temps, SE-R 2 Temps		14-		0,60	BR8ES	5422	05	BR8EIX	5044
300	1		SEF 4 Temps, SEF-R 4 Temps		14-		0,70	CR8EK	3478	-	CR8EIX	4218
305	1		ST		14-		0,60	BP5ES	6511	-	BPR5EIX	6597
320			3.2 4T		05-		0,60	BCPR6E	1269	-	BCPR6EIX	5689
450	1		4.5 4T		04-		0,60	CR8EK	3478	-	CR8EIX	4218
450			4.5i Enduro		05-		0,60	CR8EK	3478	-	CR8EIX	4218
510	1	SE	5.1 Moteur 4 temps		05-		0,70	CR8EK	3478	-	CR8EIX	4218



SHERCO-HRD

50	1		0.5 Enduro / Super Motard		02-		0,60	BR8ES	5422	05	BR8EIX	5044
----	---	--	---------------------------	--	-----	--	------	-------	------	----	--------	------



SHE LUNG

50	1		Club, Racer		-		0,70	BP7HS	5111	14	BPR7HIX	5944
----	---	--	-------------	--	---	--	------	-------	------	----	---------	------







SHINERAY - Quad

250	1				12-		0,90	DPR7EA-9	5129	13	DPR7EIX-9	7803
-----	---	--	--	--	-----	--	------	----------	------	----	-----------	------



SKI-DOO / BOMBARDIER - Motoneige

120	1	Mini Z	98-03	0,60	BPR6ES	7822	-	BPR6EIX	6637
247		250 (10-12HP)	-	0,50	AB-6	2910	-	-	-
247		250 (14HP)	-	0,50	AB-7	3010	-	-	-
247		250 Deluxe, 250T	-	0,50	B7HS	5110	03	BR7HIX	7067
247		250SS	-	0,50	B8HS	5510	01	BR8HIX	7001
250		247 Elan, Spirit	-	0,50	AB-7	3010	-	-	-
253		Citation L/S, Tunda, -LT	-	0,50	BR9ES	5722	02	BR9EIX	3981
280		Tundra F	04-	0,50	BR9ES	5722	02	BR9EIX	3981
299		300 (12.0HP)	-	0,50	AB-6	2910	-	-	-
299		300S	-	0,50	AB-7	3010	-	-	-
300		300 MX-Z300 / Fan	-	0,50	BR9ES	5722	02	BR9EIX	3981
337		TNT, RV340, Sonic 340	-	0,50	-	-	-	BR10EIX	6801
339		TNT340 Free Air	-	0,50	B9ES	2611	02	BR9EIX	3981
339		TNT340SM	-	0,50	B8HS	5510	01	BR8HIX	7001
339		354 Blizzard 6500, 354 Super Sonic / LC	-	0,50	-	-	-	BR10EIX	6801
368		300 Touring 300 / Fan	-	0,50	BR9ES	5722	02	BR9EIX	3981
368		Formula S, 368 MX-Z380 / Fan	-	0,50	BR9ES	5722	02	BR9EIX	3981
368		368 Touring 380 / Fan, 377 Safari Saga	-	0,50	BR9ES	5722	02	BR9EIX	3981
377		377 Touring E / ELT, 380 Formula Deluxe 380	-	0,40	BR9ES	5722	02	BR9EIX	3981
380		380 Scandic 380	-	0,40	BR9ES	5722	02	BR9EIX	3981
380	F	Legend Fan, GT, MX Z Fan	04-	0,50	BR9ES	5722	02	BR9EIX	3981
400		400 MX-Z400 / Fan	-	0,50	BR9ES	5722	02	BR9EIX	3981
436		440 MX-Z 440 / F	-	0,40	BR9ES	5722	02	BR9EIX	3981
436		444 Elite, 444 LC Everest, Futura	-	0,50	B8ES	2411	05	BR8EIX	5044
437		TNT440 Free Air 18mm Head	-	0,50	AB-7	3010	-	-	-
437		TNT440 Free Air 14mm Head	-	0,50	B9ES	2611	02	BR9EIX	3981
437		440 Skandic LC / LT440	-	0,50	BR9ES	5722	02	BR9EIX	3981
437		447 Grand Luxe	-	0,50	BR8ES	5422	05	BR8EIX	5044
437		454 Blizzard 9500 / Plus	-	0,50	-	-	-	BR10EIX	6801
440			04-	0,50	BR9ECS-5	6669	-	-	-
440		Touring LE	-	0,40	BR9ES	5722	02	BR9EIX	3981
440	F	Skandic LT	04-	0,50	BR9ES	5722	02	BR9EIX	3981
447		447 Safari 1986	-	0,50	BR9ES	5722	02	BR9EIX	3981
463		454 Ultra Sonic	-	0,50	-	-	-	BR10EIX	6801
494		Formula SLS	-	0,50	BR9ES	5722	02	BR9EIX	3981
494		Skandic WT LC	-	0,50	BR8ES	5422	05	BR8EIX	5044
494		Summit 500	-	0,50	BR9ES	5722	02	BR9EIX	3981
496		467 Formula MX, 467 Formula LT	-	0,50	BR9ES	5722	02	BR9EIX	3981
496		503 Alpine II	-	0,50	BR8ES	5422	05	BR8EIX	5044
497		Formula Deluxe / LC / Fan	-	0,40	BR9ES	5722	02	BR9EIX	3981
497		Scandic SWT / WT / LC	-	0,40	BR9ES	5722	02	BR9EIX	3981
497		Summit Fun / Touring Fan	-	0,50	BR9ES	5722	02	BR9EIX	3981
497		503 Safari Cheyenne / Escapade	-	0,50	BR9ES	5722	02	BR9EIX	3981
497		503 Sonic MX 1983	-	0,50	BR7ES	5122	-	BR7EIX	6664
499		500 Formula Z / Grand Touring	-	0,40	BR9ES	5722	02	BR9EIX	3981
499		500 MX-Z Trail / Fan	-	0,40	BR9ES	5722	02	BR9EIX	3981
500		Scandic / SWT / WT / WT LC	-	0,40	BR9ES	5722	02	BR9EIX	3981
500	SS	GSX Sport, 1+1, Legend Sport, Sport GT	04-	0,50	BR9ECS-5	6669	-	-	-
500	SS	MX Z Adrenaline, MX Z Trail	04-	0,50	BR9ECS-5	6669	-	-	-
503		503 Formula SL	-	0,50	BR9ES	5722	02	BR9EIX	3981
521		536 Formula Plus / LT	-	0,50	BR9ES	5722	02	BR9EIX	3981
550	F	Skandic Sport/SUV/SWT/WT	04-	0,50	BR9ES	5722	02	BR9EIX	3981
550	F	Legend Fan, GT, MX Z Fan, Summit Fan	04-	0,50	BR9ES	5722	02	BR9EIX	3981
581		583 Formula Deluxe	-	0,40	BR9ES	5722	02	BR9EIX	3981
581		Grand Touring	-	0,50	BR9ES	5722	02	BR9EIX	3981
583		Summit	-	0,50	BR9ES	5722	02	BR9EIX	3981
599		Formula III, Formula III LT	-	0,50	BR10ES	4832	-	BR10EIX	6801
600		Ace	12-	0,80	MR7BI-8	90982	-	-	-
600		Formula III	-	0,50	BR10ES	4832	-	BR10EIX	6801
600		Formula Delux	-	0,50	BR9ES	5722	02	BR9EIX	3981
600		Expedition	06-	0,80	BR8ECS	3972	-	-	-
600		Formula Z	-	0,50	BR9ES	5722	02	BR9EIX	3981
600		GSX SDI	06-	0,80	BR8ECS	3972	-	-	-
600		GSX LTD	09-	0,80	PZFR6F	7550	-	-	-
600		Grand Touring / SE	-	0,50	BR9ES	5722	02	BR9EIX	3981
600		MX Z Adrenaline	06-	0,50	BR9ECS-5	6669	-	-	-
600		MXZ 50TH, X, Adrenaline, TNT	09-	0,80	PZFR6F	7550	-	-	-
600		MX Z SDI	06-	0,80	BR8ECS	3972	-	-	-
600		MX-Z / Trail	-	0,50	BR9ES	5722	02	BR9EIX	3981
600		Skandic SUV / WT LC	04-	0,50	BR9ECS-5	6669	-	-	-
600		Summit	06-	0,80	BR8ECS	3972	-	-	-
600		Summit Everest, X	09-	0,80	PZFR6F	7550	-	-	-

CYL.	Nb Cyl.	TYPE	MODÈLE		INFO			N° STOCK	N° BLISTER		N° STOCK IX
600			XP, XR, XU	08-		0,80	PZFR6F	7550	-	-	-
600		HO	GSX Sport, 1+1	04-		0,50	BR9ECS-5	6669	-	-	-
600		HO	MX Z, Adrenaline, Renegade	04-		0,50	BR9ECS-5	6669	-	-	-
600		HO	Summit Adren, X	04-		0,50	BR9ECS-5	6669	-	-	-
600		HO SDI	Legend SE/SE GT/Sport/Sport GT	04-		0,50	BR9ECS-5	6669	-	-	-
600		HO SDI	GSX Limited, Limited 1+1, Sport	04-		0,50	BR9ECS-5	6669	-	-	-
600		HO SDI	MX Z Adrenaline, Renegade, X	04-		0,50	BR9ECS-5	6669	-	-	-
635			640 ER Alpine	-		0,50	B7HS	5110	03	BR7HIX	7067
669			670 MX-Z H.O.	-		0,40	BR9ES	5722	02	BR9EIX	3981
670			670 Formula SS / Z	-		0,50	BR9ES	5722	02	BR9EIX	3981
670			Mach 1	-		0,50	BR10ES	4832	-	BR10EIX	6801
670			Summit / X	-		0,50	BR9ES	5722	02	BR9EIX	3981
699			Mach 1	-		0,40	BR10ES	4832	-	BR10EIX	6801
699			Formula Z 600	-		0,50	BR9ES	5722	02	BR9EIX	3981
699			MX-Z 700 / Trail 700, 700 Grand Touring	-		0,50	BR9ES	5722	02	BR9EIX	3981
700		SE	Légend SE, SE GT, Sport, Sport GT	04-		0,50	BR9ECS-5	6669	-	-	-
765			Grand Touring SE	-		0,50	BR9ES	5722	02	BR9EIX	3981
765			Mach Z, MX2600, MX2700	-		0,50	BR9ES	5722	02	BR9EIX	3981
765			Summit 700, Skandic WT LC	-		0,50	BR9ES	5722	02	BR9EIX	3981
779			Mach Z / ZLT	-		0,50	BR10ES	4832	-	BR10EIX	6801
796			Grand Touring SE, Mach Z800	-		0,50	BR9ES	5722	02	BR9EIX	3981
798			Grand Touring SE	-		0,50	BR10ES	4832	-	BR10EIX	6801
800			Summit	-		0,50	BR9ES	5722	02	BR9EIX	3981
800		HO	GSX Limited, Limited 1+1, MX Z Adrenaline	04-		0,50	BR9ECS-5	6669	-	-	-
800		HO	Renegade, X, Summit Adrenaline	04-		0,50	BR9ECS-5	6669	-	-	-
800		HO	HM, HM X, HM Xtrême, Sport, X	04-		0,50	BR9ECS-5	6669	-	-	-
800			Summit X R, R E-Tec	12-		0,80	PFR7AB	93322	-	-	-
809			Mach Z	-		0,40	BR10ES	4832	-	BR10EIX	6801
1000			Légend SE, SE GT, Sport, Sport GT	04-		0,80	DCPR8E	4339	-	DCPR8EIX	6546
1000			Elite SE	04-		0,80	DCPR8E	4339	-	DCPR8EIX	6546
1000			Expedition, MXZ	06-		0,80	BR8ECS	3972	-	-	-
1000		SDI	Mach Z Adrenaline 2Temps	05-		0,50	BR9ECS-5	6669	-	-	-
1000		SDI	Summit Highmark 2T	05-		0,50	BR8ECS	3972	-	-	-



SKYTEAM

100	1		Dax	-		0,70	CR7HSA	4549	07	CR7HIX	7544
125	1		Dax	08-		0,70	CR7HSA	4549	07	CR7HIX	7544
125			Wacky ST125/Y	-		0,70	C7HSA	4629	07	CR7HIX	7544



SMC

50			NAF 50 Navigator, NGF 50 Sports Force	-		0,60	BPR7HS	6422	14	BPR7HIX	5944
50			NKF 50 on/off road, NLFR 50 Caprillio	-		0,60	BPR7HS	6422	14	BPR7HIX	5944
50			PAF 50 Partner, SBF 50 Super	-		0,60	BPR7HS	6422	14	BPR7HIX	5944
90			NGN 90 Sports Force, SBN 90 Super	-		0,60	BPR7HS	6422	14	BPR7HIX	5944
100			NKO 100 on/off road, SBO 100 Super	-		0,60	BPR7HS	6422	14	BPR7HIX	5944
125			CHP 125 Chopper	-		0,70	DR8EA	7162	11	DR8EIX	6681



SPIGAOU

50	1		Dax	-		0,70	CR7HSA	4549	07	CR7HIX	7544
125	1		Dax (moteur Loncin)	-		0,70	CR7HSA	4549	07	CR7HIX	7544







SUNDIRO

50	1		Speedy 50	96-		0,60	-	-	-	BR9EIX	3981
80	1		Speedy 80	-		0,60	-	-	-	BR9EIX	3981
125	1		Phönix XDZ 125 T/TA	96-		0,60	CR7HSA	4549	07	CR7HIX	7544
125	1		Phönix XDZ TN	96-		0,60	DR8EA	7162	11	DR8EIX	6681



SUZUKI

50	1	A	M/PM/PB-D	-		0,70	B8HS	5510	01	BR8HIX	7001
50	1	A	PS	-		0,70	BPR6HS	7022	-	BPR6HIX	4085
50	1	AE	L, M, N, P, R, T	90-99		0,70	BPR6HS	7022	-	BPR6HIX	4085
50	1	AH		92-		0,60	BPR6HS	7022	-	BPR6HIX	4085
50	1	AH	Adress	92-		0,70	BPR6HS	7022	-	BPR6HIX	4085
50	1	AH	FD	-		0,70	BPR6HS	7022	-	BPR6HIX	4085
50	1	AH	GP	95-		0,60	BPR6HS	7022	-	BPR6HIX	4085
50	1	AJ	ZZ	95-		0,50	BPR7HS	6422	14	BPR7HIX	5944
50	1	AP	R	94-		0,70	BPR6HS	7022	-	BPR6HIX	4085
50	1	AP	S	95-		0,70	BPR6HS	7022	-	BPR6HIX	4085

CYL.	Nb Cyl.	TYPE	MODÈLE		INFO			N° STOCK	N° BLISTER		N° STOCK IX
50	1	AP	T	96-		0,70	BPR6HS	7022	-	BPR6HIX	4085
50	1	AP	V / W	94-		0,70	BPR6HS	7022	-	BPR6HIX	4085
50	1	AY	Katana Air (V,W)	97-98		0,70	BPR6HS	7022	-	BPR6HIX	4085
50	1	AY	Katana Air (X,Y)	99-		0,70	BPR7HS	6422	14	BPR7HIX	5944
50	1	AY	W Katana liquide (W,X)	98-		0,70	BPR7HS	6422	14	BPR7HIX	5944
50	1	AY	A K5	05-		0,60	CPR8E	7411	-	-	-
50			CL50D, CS50D, FS50 Snip	-		0,70	BPR4HS	7823	-	-	-
50	1	CP	CHF (Scooter)	-		0,70	BPR6HS	7022	-	BPR6HIX	4085
50		DR		-		0,60	BR7HS	4122	03	BR7HIX	7067
50	1	GT	PE-B	-		0,70	BPR6HS	7022	-	BPR6HIX	4085
50	1	JR	(H > K1)	87-		0,70	BP4HS	3611	-	-	-
50	1	RM	T, X, Z, D	80-95		0,70	BR7HS	4122	03	BR7HIX	7067
50	1	RMX	T,V,W,X,Y,K1	96-		0,70	BPR8ES	3923	-	BPR8EIX	6684
50	1	RV	L/PN	-		0,70	BPR6HS	7022	-	BPR6HIX	4085
50	1	SMX	X / Y / K1	99-		0,70	BPR8ES	3923	-	BPR8EIX	6684
50	1	TR	S Street Magic (W,X)	98-		0,70	BPR6HS	7022	-	BPR6HIX	4085
50	1	TS	PC/XAM R	-		0,70	BPR6HS	7022	-	BPR6HIX	4085
50	1	UF	Estilite	00-		0,80	BPR7HS	6422	14	BPR7HIX	5944
50	1	UX	Zillion (W,X)	98-		0,70	BPR7HS	6422	14	BPR7HIX	5944
65	1	RM		03-		0,70	BR10EG	3830	-	-	-
70	1	DR-Z		08-		0,70	CR7HSA	4549	07	CR7HIX	7544
80	1	CP	C H F (Scooter)	-		0,70	BPR6HS	7022	-	BPR6HIX	4085
80	1	CS	CD	-		0,70	BPR6HS	7022	-	BPR6HIX	4085
80	1	DS	T,V,W,X,Y	93-00		0,70	B7ES	1111	-	BR7EIX	6664
80	1	GT	LX	-		0,80	B8ES	2411	05	BR8EIX	5044
80	1	JR		01-		0,70	BP7ES	2412	-	BPR7EIX	4055
80	1	RG	EX	-		0,80	B8ES	2411	05	BR8EIX	5044
80	1	RM	XM	92-95		0,70	BR10ES	4832	-	BR10EIX	6801
80	1	RM	X-T	-		0,70	B8ES	2411	05	BR8EIX	5044
80	1	RM	M	-		0,70	BR10ES	4832	-	BR10EIX	6801
80	1	RMX	T,V,W,X,Y,K1	96-		0,70	BR10ES	4832	-	BR10EIX	6801
80	1	RT	Z(OVNI)	-		0,70	B7ES	1111	-	BR7EIX	6664
85	1	RM		01-07		0,60	BR10ES	4832	-	BR10EIX	6801
85	1	RM		08-		0,80	BR10ES	4832	-	BR10EIX	6801
100		AH	F	-		0,70	BPR7HS	6422	14	BPR7HIX	5944
100	1	RM		04-		0,70	R6252K-105	2741	-	-	-
110		DR	Z	03-		0,70	CR6HSA	2983	-	CR6HIX	7274
120		B	M	-		0,70	BR7HS	4122	03	BR7HIX	7067
125			Address	08-		0,80	CR8E	1275	04	CR8EIX	4218
125	1		Burgman	07-		0,80	CR8E	1275	04	CR8EIX	4218
125			Marauder	08-		0,80	CR7E	4578	12	CR7EIX	7385
125	1		Sixteen	08-		0,70	CR8E	1275	04	CR8EIX	4218
125	1	AN		95-96		0,70	CR8E	1275	04	CR8EIX	4218
125	1	AN		97-99		0,70	CR7E	4578	12	CR7EIX	7385
125	1	AN	S	95-		0,70	CR8EK	3478	-	CR8EIX	4218
125	1	AN	T	96-		0,70	CR8E	1275	04	CR8EIX	4218
125	1	AN	V / W / X	97-00		0,70	CR9E	6263	06	CR9EIX	3521
125		DF	E (X)	99-		0,70	DR8EA	7162	11	DR8EIX	6681
125		DR	SE (R,S,W,X,Y,K1)	94-		0,70	DR8EA	7162	11	DR8EIX	6681
125		DR	SM	08-		0,70	CR8E	1275	04	CR8EIX	4218
125		DR-Z	L	08-		0,70	DR8EA	7162	11	DR8EIX	6681
125	1	FL	DW	08-		0,70	CR6HSA	2983	-	CR6HIX	7274
125		GN	R,V,W,X,Y,K1	91-		0,70	DR8EA	7162	11	DR8EIX	6681
125		GP	Tout modèle	-		0,70	B8HS	5510	01	BR8HIX	7001
125		GS	ESD	-		0,70	DR8ES-L	2923	-	DR8EIX	6681
125		GZ	Marauder (W,X,Y)	98-		0,70	DR8EA	7162	11	DR8EIX	6681
125		GZ	K4K5	04-		0,70	CR8E	1275	04	CR8EIX	4218
125		RG	FU-N / P / R / U Wolf	-		0,70	BR9ECM	3252	-	BR9ECMIX	2707
125		RM	PRS	93-95		0,60	R4118S-9	3245	-	-	-
125		RM	T,U,W,X,Y,K1-K8	96-		0,60	R6918B-8	4492	-	-	-
125		RM		93-		0,70	BR9EG	3230	-	-	-
125	1	RM		02-		0,60	R6918B-8	4492	-	-	-
125		RV	Van Van	03-		0,70	CR8E	1275	04	CR8EIX	4218
125		TU	XT (X)	99-		0,70	DR8EA	7162	11	DR8EIX	6681
125		UC	Epicuro (X,Y)	99-		0,70	CR8E	1275	04	CR8EIX	4218
125	1	UE	K1	01-		0,70	CR7E	4578	12	CR7EIX	7385
125	1	UH	Burgman	02-		0,80	CR8E	1275	04	CR8EIX	4218
125		UX	Sixteen	07-		0,80	CR8E	1275	04	CR8EIX	4218
125		VL	Intruder Classic, LC	99-		0,70	CR8E	1275	04	CR8EIX	4218
150	1	UX	Sixteen 150	08-		0,70	CR8E	1275	04	CR8EIX	4218
200		AN	K7 Burgman	07-		0,70	CR8EK	3478	-	CR8EIX	4218
200		DR	S	-		0,60	DR8ES-L	2923	-	DR8EIX	6681
200		GT	X5	-		0,70	B8ES	2411	05	BR8EIX	5044
200		TS	R M	91-		0,70	BR9ES	5722	02	BR9EIX	3981
200	1	UH	Burgman	07-		0,70	CR8EK	3478	-	CR8EIX	4218
250	1	AN	Burgman (W)	98-99		0,80	CR8EK	3478	-	CR8EIX	4218

CYL.	Nb Cyl.	TYPE	MODÈLE		INFO			N° STOCK	N° BLISTER		N° STOCK IX
250	1	AN	Burgman (K4-K5)	04-		0,70	CR7EK	7546	-	CR7EIX	7385
250		GN	F / K / M / N / P / R / T	85-96		0,70	DR8ES-L	2923	-	DR8EIX	6681
250		GSX	E, T, X	-		0,70	DR8ES-L	2923	-	DR8EIX	6681
250		GT	AB	-		0,70	B9ES	2611	02	BR9EIX	3981
250		GW	L2 Inazuma	12-		0,70	CR7E	4578	12	CR7EIX	7385
250		GZ	Marauder X	99-		0,70	DR8EA	7162	11	DR8EIX	6681
250		LT	R H	87-		0,60	B8EGV	5627	-	-	-
250		PE	B/C	-		0,50	B8EG	3430	-	-	-
250		RGV	M, N, P, R	91-		0,80	BR9ECM	3252	-	BR9ECMIX	2707
250		RM	D	-		0,60	B8EGV	5627	-	-	-
250		RM	P, R, S	92-95		0,80	R4118S-8	3236	-	-	-
250		RM	T,V,W,X,Y	96-00		0,80	R6918B-7	6259	-	-	-
250	1	RM	K1, K5	01-07		0,60	BR8EG	3130	-	-	-
250		RM	2 Temps	08-		0,60	BR8EG	3130	-	-	-
250	1	RM	Z	04-		0,60	CR8EB	7784	04	CR8EIX	4218
250	1	RM	Z	06-		1,00	CR8EIA-10	4708	-	-	-
250		RMX	K / M / N / S	89-95		0,60	B8EGV	5627	-	-	-
250		RMX	RP, T	-		0,50	-	-	-	BR9EIX	3981
250		RM-Z	K4-K5 4T	04-06		0,70	CR8EB	7784	04	CR8EIX	4218
250		RM-Z	4 Temps	08-		1,00	CR8EIA-10	4708	-	-	-
250		TS	A, B	-		0,70	B8ES	2411	05	BR8EIX	5044
250		TS	X E/RH 250	-		0,70	-	-	-	BR8EIX	5044
250		TS	XG,H/RH250	-		0,70	BR8ES	5422	05	BR8EIX	5044
250		TU	X (V)	97-		0,70	DR8ES-L	2923	-	DR8EIX	6681
250		TU	X (W,X)	98-		0,70	DR8EA	7162	11	DR8EIX	6681
350	1	DR	SE (R,S,T,V,W,X)/SER/SR	94-99		0,60	CR9EK	4548	-	CR9EIX	3521
380		GT	K	89-		0,70	B7ES	1111	-	BR7EIX	6664
400	1	AN	Burgman (X, Y, K1, K6)	99-06		0,70	CR7E	4578	12	CR7EIX	7385
400	1	AN	Burgman (K7, K8)	08-		0,80	CR7E	4578	12	CR7EIX	7385
400	1	AN	Burgman	06-		0,90	CR8EH-9	5666	10	CR8EHIX-9	3797
400		DR	S / T / X	95-97		0,70	DR8ES-L	2923	-	DR8EIX	6681
400	1	DR-Z	Y / K1 / E / SM	00-		0,70	CR8E	1275	04	CR8EIX	4218
400		GSF	Bandit P	93-		0,60	CR9EK	4548	-	CR9EIX	3521
400		GSX	F / Z	-		0,70	DR8ES-L	2923	-	DR8EIX	6681
400		GSX-R	H	86-		0,60	C8HSA	6821	-	CR8HIX	7669
400		LT	Z	04-		0,70	CR7E	4578	12	CR7EIX	7385
400		PE	T/X/Z	-		0,70	BR9EG	3230	-	-	-
400		TS	K / L / M	89-91		0,80	B8ES	2411	05	BR8EIX	5044
400		TS	A, B	-		0,80	B9ES	2611	02	BR9EIX	3981
425		GS	E, N	-		0,70	B8ES	2411	05	BR8EIX	5044
450	1	RM-Z	4 Temps	05-		1,00	CR8EIB-10	4948	-	-	-
450	1	RM-Z		08-		1,00	DIMR8A10	5066	-	-	-
450	1	RM-Z	ZL1 Enduro Inj	11-		1,00	DIMR8A10	5066	-	-	-
450	1	RMX		10-		1,00	DIMR8A10	5066	-	-	-
465		RM	X / S	-		0,70	B8EGV	5627	-	-	-
500		DR	S / X	-		0,70	DR8ES-L	2923	-	DR8EIX	6681
500	2	GS	E (K,L,M,N,P,R,S)	89-95		0,90	DPR8EA-9	4929	08	DPR8EIX-9	2202
500		GS	E (T,V,W,X,Y)	96-00		0,90	DPR8EA-9	4929	08	DPR8EIX-9	2202
500	2	GS	E (K1)	00-		0,90	DPR8EA-9	4929	08	DPR8EIX-9	2202
500	2	GS	F	04-		0,90	DPR8EA-9	4929	08	DPR8EIX-9	2202
500		GT	A, B	-		0,70	BR7HS	4122	03	BR7HIX	7067
550		GS	B, D, EC, EN, ET, L, N, T	-		0,70	B8ES	2411	05	BR8EIX	5044
600		GS	FJ	88-		0,70	DR8ES	5423	11	DR8EIX	6681
600	4	GSF	Bandit N & S (S,T,V,W,X)	95-99		0,70	CR9EK	4548	-	CR9EIX	3521
600	4	GSF	Bandit N & S (Y,K1)	00-		0,70	CR9EK	4548	-	CR9EIX	3521
600	4	GSR	K6	06-		0,70	CR9E	6263	06	CR9EIX	3521
600		GSX-F	J, K, L, M, N, P, R, S, V	88-97		0,70	DR8ES	5423	11	DR8EIX	6681
600		GSX-F	W, X, Y, K1	98-		0,90	CR9EK	4548	-	CR9EIX	3521
600	4	GSX-R	V / W / X / Y	97-00		0,70	CR9E	6263	06	CR9EIX	3521
600	4	GSX-R	K1, K7	00-		0,70	CR9E	6263	06	CR9EIX	3521
600	4	GSX-R	K6, K9	06-		0,70	CR9E	6263	06	CR9EIX	3521
600	4	GSX-R	K8	08-		0,90	CR9EIA-9	6289	-	-	-
600		VS	GL Intruder S,T,V	96-97		0,90	DPR8EA-9	4929	08	DPR8EIX-9	2202
650	4		Bandit / S	08-		0,70	CR8E	1275	04	CR8EIX	4218
650	2	AN	Burgman	02-		0,70	CR8E	1275	04	CR8EIX	4218
650	2	AN	Burgman Executive	04-		0,70	CR8E	1275	04	CR8EIX	4218
650	2	DL	V-Strom	03-		0,70	CR7E	4578	12	CR7EIX	7385
650	2	DL	Traveller V-strom K7	10-	2 Bougies par Cylindre	0,80	CR8E	1275	04	CR8EIX	4218
650	2	DL	V-Storm AUJEL 1 ABS	11-		0,80	CR8E	1275	04	CR8EIX	4218
650	2	DL	AL2 V-Storm 650 ABS	11-		0,90	CR8EIA-9	4286	-	-	-
650		DR	RN,RSL,M,RM,N,P,R,S	90-95		0,90	DPR9EA-9	5329	-	DPR9EIX-9	5545
650		DR	RSE Models and RE models	91-95		0,90	DPR9EA-9	5329	-	DPR9EIX-9	5545
650		DR	RER,S	94-95		0,90	DPR9EA-9	5329	-	DPR9EIX-9	5545
650		DR	SE (M,N,P,R,S,T)	91-96		0,90	DPR9EA-9	5329	-	DPR9EIX-9	5545
650		DR	SE (T,V,W,X,Y,K1)	96-		0,70	CR10E	6264	-	CR10EIX	6482
650		GS	GLX / GX	-		0,70	DR8ES-L	2923	-	DR8EIX	6681

SUZUKI





Bougies d'allumage

CYL.	Nb Cyl.	TYPE	MODÈLE		INFO			N° STOCK	N° BLISTER		N° STOCK IX
650	4	GSF	Bandit	05-		0,70	CR9EK	4548	-	CR9EIX	3521
650	4	GSF	Bandit N & S	07-		0,90	DPR8EA-9	4929	08	DPR8EIX-9	2202
650	4	GSF	K7 Bandit Liquid Cooled	08-		0,60	CR9E	6263	06	CR9EIX	3521
650		GSF	Bandit UE L1 / SUEL1 / SUELA1 ABS	11-		0,80	CR8E	1275	04	CR8EIX	4218
650		GSX	F	08-		0,70	CR8E	1275	04	CR8EIX	4218
650		GSX	FUEAL1 ABS/ ABS Leo Vince	11-		0,80	CR8E	1275	04	CR8EIX	4218
650	1	LS	Tout modèle	87-99		0,90	DPR8EA-9	4929	08	DPR8EIX-9	2202
650	1	LS	P Savage (J > X)	88-99		0,90	DPR8EA-9	4929	08	DPR8EIX-9	2202
650	2	SFV	UEL1 Gladius	11-		0,80	CR8E	1275	04	CR8EIX	4218
650	2	SV	N & S	99-		0,70	CR8E	1275	04	CR8EIX	4218
650	2	SV	V-Strom / S	08-		0,70	CR8E	1275	04	CR8EIX	4218
650	2	SFV	Gladius	09-		0,90	CR8EIA-9	4286	-	-	-
650	1	XF	Freewind (V,W,X)	97-99		0,70	CR10E	6264	-	CR10EIX	6482
650	1	XF	Freewind (Y,K1)	00-		0,70	CR10E	6264	-	CR10EIX	6482
650		XN	85 D Turbo	-		0,70	DR8ES	5423	11	DR8EIX	6681
750		GSR		11-		0,90	CR9EIA-9	6289	-	-	-
750		GSX	ET,EX,EZ	-		0,70	DR8ES-L	2923	-	DR8EIX	6681
750		GSX	Inazuma (X,Y,K1)	98-		0,70	CR9EK	4548	-	CR9EIX	3521
750	4	GSX-F	K/L/M/N/P/R/S/F/T/V	89-97		0,70	JR9C	6193	-	-	-
750	4	GSX-F	W, X, Y, K1, K5	98-		0,70	CR9EK	4548	-	CR9EIX	3521
750	4	GSX-R	R Racing (K)	89-		0,70	CR10EK	2360	-	CR10EIX	6482
750	4	GSX-R	W (N,P,R,S)	92-95		0,70	CR10EK	2360	-	CR10EIX	6482
750	4	GSX-R	SPR	94-		0,70	CR9E	6263	06	CR9EIX	3521
750	4	GSX-R	T,V,W,X,Y, K1-K7	96-99		0,60	CR9E	6263	06	CR9EIX	3521
750	4	GSX-R	K6	06-		0,70	CR9E	6263	06	CR9EIX	3521
750	4	GSX-R	K8	08-		0,90	CR9EIA-9	6289	-	-	-
750	4	GSX-S		16-		0,90	CR9EIA-9	6289	-	-	-
750		VS	GL S	95-		0,90	DPR8EA-9	4929	08	DPR8EIX-9	2202
800		DR	SL,SM,SN,P,R,S,T,V	90-97		0,90	DPR9EA-9	5329	-	DPR9EIX-9	5545
800	2	M	Intruder	09-		0,60	DR7EA	7839	-	DR7EIX	5686
800	2	VL	Volusia (K1)	01-		0,90	DPR7EA-9	5129	13	DPR7EIX-9	7803
800	2	VL	CL1 Intruder	11-		0,60	DR7EA	7839	-	DR7EIX	5686
800		VS	GL Intruder (N,P,R,S,W,X)	92-95		0,90	DPR8EA-9	4929	08	DPR8EIX-9	2202
800		VX	L/M/(CHOPPER)/N/P/R/T	90-96		0,90	DPR8EA-9	4929	08	DPR8EIX-9	2202
800	2	VZ	L1 Intruder M800	11-		0,60	DR7EA	7839	-	DR7EIX	5686
800		VZ	Marauder (V,W,X)	97-01		0,90	DPR8EA-9	4929	08	DPR8EIX-9	2202
850		GS	GLT	-		0,70	B8ES	2411	05	BR8EIX	5044
900		RF	RR / RS / RS2	94-95		0,80	CR9E	6263	06	CR9EIX	3521
1000	2	DL	V-Strom	02-12		0,70	CR8EK	3478	-	CR8EIX	4218
1000	2	DL	V-Strom	13-		0,90	LMAR8BI-9	91909	-	-	-
1000	4	GSX-R	K1, K6	00-06		0,70	CR9E	6263	06	CR9EIX	3521
1000	4	GSX-R	K7	07-		0,90	CR9EIA-9	6289	-	-	-
1000	2	SV	N & S	03-		0,70	CR8EK	3478	-	CR8EIX	4218
1000	2	SV	Classic	08-		0,70	CR8EK	3478	-	CR8EIX	4218
1000		TL	S (V,W,X,Y) / R (W,X,Y,K1)	97-03		0,70	CR8EK	3478	-	CR8EIX	4218
1100		GS	G / GG (GU71A) / GT	-		0,80	B8ES	2411	05	BR8EIX	5044
1200	4	GSF	Bandit N & S (T,V,W,X)	96-00		0,70	JR9B	3188	-	-	-
1200	4	GSF	Bandit N & S (Y,K1)	00-		0,70	JR9B	3188	-	-	-
1200	4	GSF	K6	06-		0,70	JR9B	3188	-	-	-
1200	4	GSX	Inazuma (X,Y)	99-		0,70	JR8B	7237	-	-	-
1250	4	GSF	Bandit	08-		0,80	CR7E	4578	12	CR7EIX	7385
1250	4	GSX	FA	10-		0,60	CR7E	4578	12	CR7EIX	7385
1300	4	GSX	B-King	07-		0,80	CR9E	6263	06	CR9EIX	3521
1300	4	GSX	B-King	08-		0,90	CR9EIA-9	6289	-	-	-
1300	4	GSX-R	Hayabusa (X,Y,K1)	99-07		0,70	CR9E	6263	06	CR9EIX	3521
1300	4	GSX-R	Hayabusa	08-		0,90	CR9EIA-9	6289	-	-	-
1400	4	GSX		01-		0,70	CR8EK	3478	-	CR8EIX	4218
1400	2	VS	GLP (H,J,K,L,M,N,P,R,S)	87-95		0,90	DPR8EA-9	4929	08	DPR8EIX-9	2202
1400	2	VS	GLP Intruder (T,V,W,X)	96-98		0,90	DPR8EA-9	4929	08	DPR8EIX-9	2202
1400	2	VS	GLP Intruder	01-		0,90	DPR8EA-9	4929	08	DPR8EIX-9	2202
1500	2	VL	Intruder Legend. Classic (W,X,K1)	98-		0,90	DPR7EA-9	5129	13	DPR7EIX-9	7803
1500		VZ	LO Intruder M1500	10-		0,70	CR6E	6965	-	-	-
1600	2		Marauder	03-		0,90	DPR6EA-9	5531	-	-	-
1600		VZ	K4-K5	03-04		0,90	DPR6EA-9	5531	-	-	-
1800	2	M	Intruder R / R / R2	06-		0,70	CR8EK	3478	-	CR8EIX	4218
1800			VLR1800 C1800R/RT Intruder	08-		0,70	CR8EK	3478	-	CR8EIX	4218
1800		VZR	Intruder ZUF L1 / MR UF L1	11-		0,70	CR8EK	3478	-	CR8EIX	4218



SUZUKI - Quad

50	1	LT	X / Y (4x2)	89-		0,70	BPR4HS	7823	-	-	-
50	1	LT	Z50	05-07		0,70	CR6HSA	2983	-	CR6HIX	7274
50	1	LT	Z	08-		0,70	CR6HSA	2983	-	CR6HIX	7274
50	1	LT-A	K2 (4x2)	01-		0,70	BPR4HS	7823	-	-	-
80	1	LT	L/M/N/P/R/S/T/W/X/Y (4x2)	90-		0,70	BPR7HS	6422	14	BPR7HIX	5944

CYL.	Nb Cyl.	TYPE	MODÈLE		INFO			N° STOCK	N° BLISTER		N° STOCK IX
80	1	LT		08-		0,70	BPR7HS	6422	14	BPR7HIX	5944
90	1	LT	Z	06-		0,70	CR6HSA	2983	-	CR6HIX	7274
160	1	LT	E	-		0,70	D7EA	7912	-	DR7EIX	5686
160	1	LT	E	93-		0,90	DPR7EA-9	5129	13	DPR7EIX-9	7803
160	1	LT	F	93-		0,90	DP7EA-9	5629	13	DPR7EIX-9	7803
160	1	LT-F		95-		0,90	DP7EA-9	5629	13	DPR7EIX-9	7803
230	1	LT	E	93-		0,70	D7EA	7912	-	DR7EIX	5686
230	1	LT	E/F	-		0,70	DR7ES	3123	-	DR7EIX	5686
230	1	LT	GE	-		0,70	D7EA	7912	-	DR7EIX	5686
250	1	LT	4WD	-		0,70	DR7ES	3123	-	DR7EIX	5686
250	1	LT	E/EF	93-		0,70	D8EA	2120	11	DR8EIX	6681
250	1	LT	EF	-		0,70	DR8ES-L	2923	-	DR8EIX	6681
250	1	LT	R	-		0,60	-	-	-	BR8EIX	5044
250	1	LT	R	93-		0,60	B9EGV	5827	-	-	-
250	1	LT	S	-		0,90	DPR7EA-9	5129	13	DPR7EIX-9	7803
250	1	LT-F		93-		0,70	DR7ES	3123	-	DR7EIX	5686
250	1	LT-F		-		0,70	DR7ES	3123	-	DR7EIX	5686
250	1	LT-F		95-		0,60	D7EA	7912	-	DR7EIX	5686
250	1	LT-F	4WD	-		0,70	DR7ES	3123	-	DR7EIX	5686
250		LT-F	Ozark (4x2)	02-		0,80	DR7EA	7839	-	DR7EIX	5686
280	1	LT	4WD	95-		0,60	DR7EA	7839	-	DR7EIX	5686
280	1	LT	4WD X	95-		0,60	D7EA	7912	-	DR7EIX	5686
280	1	LT-F	4WD	95-		0,60	DR7EA	7839	-	DR7EIX	5686
280	1	LT-F	4WD X	93-		0,70	DR7ES	3123	-	DR7EIX	5686
300	1	LT		87-		0,60	D8EA	2120	11	DR8EIX	6681
300	1	LT-F		99-		0,60	D7EA	7912	-	DR7EIX	5686
400			KingQuad	08-		0,80	CR7E	4578	12	CR7EIX	7385
400		LT-A	F Auto (4x4)	02-		0,70	CR7E	4578	12	CR7EIX	7385
400		LT-F	F Méca (4x4)	02-		0,70	CR7E	4578	12	CR7EIX	7385
400		LT-Z		02-		0,80	CR8E	1275	04	CR8EIX	4218
400		Z	QuadSport	08-		0,80	CR7E	4578	12	CR7EIX	7385
450		LT-R	KingQuad	06-		0,80	CR8EB	7784	04	CR8EIX	4218
500		LT-A	F Auto (4x4)	01-		0,70	CR6E	6965	-	-	-
500		LT-F	F Méca (4x4)	01-		0,70	CR6E	6965	-	-	-
750			KingQuad	08-		0,70	CR6E	6965	-	-	-



SUZUKI - Motoneige





292		Nomad	-		0,70	B7HS	5110	03	BR7HIX	7067
336		Nomad	-		0,70	B7HS	5110	03	BR7HIX	7067
340		F / C	-		0,80	BR9EYA	7548	-	BR9EIX	3981
360		SM10 / SM10D	-		0,70	B7HS	5110	03	BR7HIX	7067
370		370F/C	-		0,80	BR9EYA	7548	-	BR9EIX	3981
395		400 Wide Track, SM20	-		0,70	B7HS	5110	03	BR7HIX	7067
395		SM20 Hop Up Kit	-		0,70	B8ES	2411	05	BR8EIX	5044
395		XR400	-		0,70	B7HS	5110	03	BR7HIX	7067
400		440 L/C-ZRV	98-		0,70	BR10ES	4832	-	BR10EIX	6801
400		440 L/C-ZRV	99-		0,80	-	-	-	BR10EIX	6801
400		440 L/C-ZRV	00-		0,80	BR9EYA	7548	-	BR9EIX	3981
432		XR440	-		0,70	B7HS	5110	03	BR7HIX	7067
433		440 F/C	-		0,80	BR9EYA	7548	-	BR9EIX	3981
433		440 F/C-C	-		0,80	BR9ES	5722	02	BR9EIX	3981
433		440 L/C-LWS	-		0,80	BR9EYA	7548	-	BR9EIX	3981
433		SM440M	-		0,70	-	-	-	BR9EIX	3981
500		F / C	-		0,80	BR9ES	5722	02	BR9EIX	3981
500		L/C	00-		0,80	-	-	-	BR10EIX	6801
500		L/C - L/C-EID	99-		0,80	BR9EYA	7548	-	BR9EIX	3981
530		L/C	-		0,70	BR10ES	4832	-	BR10EIX	6801
530		550 L/C	-		0,80	BR9EYA	7548	-	BR9EIX	3981
580		L/C-EID	-		0,80	BR9EYA	7548	-	BR9EIX	3981
600		L/C - L/C-EID	-		0,80	BR9EYA	7548	-	BR9EIX	3981
650		L/C	-		0,70	BR10ES	4832	-	BR10EIX	6801
700		L/C	99-		0,70	BR10ES	4832	-	BR10EIX	6801
700		L/C	-95		0,80	BR9ES	5722	02	BR9EIX	3981
785		L/C	-		0,80	BR9EYA	7548	-	BR9EIX	3981
800		L/C	-		0,80	BR9EYA	7548	-	BR9EIX	3981
900		L/C	-		0,80	BR9EYA	7548	-	BR9EIX	3981
1000		L/C	-		0,80	BR9EYA	7548	-	BR9EIX	3981



SYM

50		City Hopper	98-03		0,60	BR8HSA	5539	-	BR8HIX	7001
50	1	DD50 City Trek / Sport	02-		0,60	BR8HSA	5539	-	BR8HIX	7001
50	1	Fancy / Flash / Free	96-		0,70	BR8HSA	5539	-	BR8HIX	7001
50	1	Fiddle	98-		0,60	BR8HSA	5539	-	BR8HIX	7001

SYM

CYL.	Nb Cyl.	TYPE	MODÈLE		INFO			N° STOCK	N° BLISTER		N° STOCK IX
50			Fiddle II 50	08-	0,70		BR8HSA	5539	-	BR8HIX	7001
50	1		Fiddle II 50	-	0,60		CR7HSA	4549	07	CR7HIX	7544
50	1		Jet	96-	0,70		BR8HSA	5539	-	BR8HIX	7001
50	1		Jet 50 BasiX / 50 Euro X / 50 Sport X R	-	0,60		BR8HSA	5539	-	BR8HIX	7001
50	1		Jet 50 Sport X S / X SE / X SR / X XS	06-	0,70		BR8HSA	5539	-	BR8HIX	7001
50	1		Jungle	99-	0,70		BR8HSA	5539	-	BR8HIX	7001
50	1		Mask	00-	0,70		BR8HSA	5539	-	BR8HIX	7001
50			Mio	05-	0,70		CR6HSA	2983	-	CR6HIX	7274
50	1		Orbit 50	-	0,60		CR7HSA	4549	07	CR7HIX	7544
50	1		Pure 50	96-	0,60		BR8HSA	5539	-	BR8HIX	7001
50	1		Red Devil	99-	0,70		BR8HSA	5539	-	BR8HIX	7001
50	1		Shark	00-	0,70		BPR8HS	3725	-	BPR8HIX	6742
50	1		Shark	-	0,60		BR8HSA	5539	-	BR8HIX	7001
50	1		Simply, Symphony	09-	0,70		CR7HSA	4549	07	CR7HIX	7544
50			Super Fancy	98-03	0,60		BR8HSA	5539	-	BR8HIX	7001
50	1	DD		05-	0,70		BR8HSA	5539	-	BR8HIX	7001
50	1	RS		05-	0,60		BR8HSA	5539	-	BR8HIX	7001
50	1	RS	Shark	-	0,60		BR8HSA	5539	-	BR8HIX	7001
50	1	SK		00-	0,70		BR8HSA	5539	-	BR8HIX	7001
100			Jet	99-	0,60		BR8HSA	5539	-	BR8HIX	7001
100			Jet 100 Sport X S/SR Jet	-	0,60		BR8HSA	5539	-	BR8HIX	7001
100			Mio	-	0,70		CR6HSA	2983	-	CR6HIX	7274
125			Attila	98-00	0,60		CR7HSA	4549	07	CR7HIX	7544
125	1		Euro MX	01-	0,70		CR8E	1275	04	CR8EIX	4218
125	1		Euro MX 125 4V	05-	0,70		CR8E	1275	04	CR8EIX	4218
125			Fiddle II	08-	0,60		CR7HSA	4549	07	CR7HIX	7544
125	1		Husky	02-	0,70		DR8EA	7162	11	DR8EIX	6681
125	1		Joyride	02-	0,70		CR8E	1275	04	CR8EIX	4218
125	1		Joyride	03-04	0,60		CR7HSA	4549	07	CR7HIX	7544
125	1		Joyride 125 E2/3 / Evo	05-	0,70		CR8E	1275	04	CR8EIX	4218
125			Megalo 125	01-	0,60		CR7HSA	4549	07	CR7HIX	7544
125	1		Orbit	-	0,60		CR7HSA	4549	07	CR7HIX	7544
125			Shark 125, Shark 125 R	99-05	0,80		CR8E	1275	04	CR8EIX	4218
125	1		Simply, Symphony	09-	0,70		CR7HSA	4549	07	CR7HIX	7544
125			Super Duke	96-	0,60		CR7HSA	4549	07	CR7HIX	7544
125			Voyager	-	0,70		CR8E	1275	04	CR8EIX	4218
125	1		Wolf	05-09	0,70		DR8EA	7162	11	DR8EIX	6681
125	1		Wolf	10-	0,70		DR7EA	7839	-	DR7EIX	5686
125	1	CT		04-	0,70		DR8EA	7162	11	DR8EIX	6681
125	1	GTS		06-	0,70		CR8E	1275	04	CR8EIX	4218
125	1	GTS	E2 / E3	-	0,70		CR8E	1275	04	CR8EIX	4218
125		GTS	Voyager	05-	0,80		CR8E	1275	04	CR8EIX	4218
125	1	HD		04-	0,70		DR8EA	7162	11	DR8EIX	6681
125	1	HD		05-08	0,70		CR8E	1275	04	CR8EIX	4218
125	1	HD	Evo	06-	0,70		CR8E	1275	04	CR8EIX	4218
125		HD2		10-	0,70		CR8E	1275	04	CR8EIX	4218
125	1	RS	4V	05-	0,70		CR8E	1275	04	CR8EIX	4218
125	1	SK		01-	0,70		CR8E	1275	04	CR8EIX	4218
125		VS		06-	0,70		CR8E	1275	04	CR8EIX	4218
125	1	XS	K	-	0,70		DR8EA	7162	11	DR8EIX	6681
150			Fiddle II	10-	0,70		CR7HSA	4549	07	CR7HIX	7544
150	1		Joyride 150	-	0,70		CR8E	1275	04	CR8EIX	4218
150			Symphony	10-	0,70		CR7HSA	4549	07	CR7HIX	7544
150	1		VS	07-	0,70		CR8E	1275	04	CR8EIX	4218
180			HD Orbit 180	04-	0,70		CR8E	1275	04	CR8EIX	4218
180			Joyride 180	02-	0,70		CR8E	1275	04	CR8EIX	4218
200	1	HD		05-	0,70		CR8E	1275	04	CR8EIX	4218
200	1	HD 2		10-	0,80		CR7E	4578	12	CR7EIX	7385
200			Joyride	05-	0,70		CR8E	1275	04	CR8EIX	4218
200	1		Maxsym	10-	0,70		CR8E	1275	04	CR8EIX	4218
250	1	GTS	250	06-	0,70		CR8E	1275	04	CR8EIX	4218
250	1	GTS	250 E2, 250i E3	-	0,70		CR8E	1275	04	CR8EIX	4218
250	1		Joymax	06-	0,70		CR8E	1275	04	CR8EIX	4218
300			Citycom i, Joymax Evo	08-	0,70		CR8E	1275	04	CR8EIX	4218
300		GTS		-	0,70		CR8E	1275	04	CR8EIX	4218
400			MaxSym	10-	0,70		CR8E	1275	04	CR8EIX	4218
500	1		GT, XP	04-	0,60		CR7EKB	4455	-	CR7EIX	7385



SYM - Quad

200			Track Runner 200	06-	0,80		CR8HSA	2086	-	CR8HIX	7669
250			GTS	06-	0,70		CR8E	1275	04	CR8EIX	4218
250			Quadlander	06-	0,80		CR8HSA	2086	-	CR8HIX	7669
300	1		Quadlander 300	-	0,70		CR8E	1275	04	CR8EIX	4218
500			GT, XP	04-	0,60		CR7EKB	4455	-	CR7EIX	7385
600	1		Quadlander 600, Quadraider LE	-	0,70		CR8E	1275	04	CR8EIX	4218



TGB (Taiwan Golden Bee)

50		202 Classic	02-	0,50	BPR7HS	6422	14	BPR7HIX	5944
50	1	202T (Big Wheels)	98-	0,70	BPR7HS	6422	14	BPR7HIX	5944
50	1	302 Sport, 303 R Hawk	02-	0,70	BPR7HS	6422	14	BPR7HIX	5944
50	1	AKROStec	03-05	0,70	BPR7HS	6422	14	BPR7HIX	5944
50	1	Bunny AS 50 X	-	0,60	BP6HS	4511	-	BPR6HIX	4085
50	1	Delivery	03-	0,70	BPR7HS	6422	14	BPR7HIX	5944
50	1	Ergon	98-	0,70	BPR7HS	6422	14	BPR7HIX	5944
50	1	KBX 50	-	0,60	BP6HS	4511	-	BPR6HIX	4085
50	1	R50X	05-	0,70	BPR7HS	6422	14	BPR7HIX	5944
125	1	202T (Palio)	98-	0,70	CR7HSA	4549	07	CR7HIX	7544
125	1	204 Classic	02-07	0,70	CR7HSA	4549	07	CR7HIX	7544
125		303 R	-	0,70	CR7HSA	4549	07	CR7HIX	7544
125		303 R Hawk	07-	0,70	CR7HSA	4549	07	CR7HIX	7544
125		304 Sport	02-	0,70	CR7HSA	4549	07	CR7HIX	7544
125		309 RS	-	0,70	CR7HSA	4549	07	CR7HIX	7544
125		404 Executive	02-07	0,70	CR7HSA	4549	07	CR7HIX	7544
125		F409 / Laser	-	0,70	CR7HSA	4549	07	CR7HIX	7544
125		Delivery	05-	0,70	CR7HSA	4549	07	CR7HIX	7544
125		R125X	08-	0,70	CR7HSA	4549	07	CR7HIX	7544
150		303R, 309RS, F409 / Laser	-	0,70	CR7HSA	4549	07	CR7HIX	7544



TGB (Taiwan Golden Bee) - Quad

90	1	Hornet 90	-	0,70	BPR7HS	6422	14	BPR7HIX	5944
250		Blade E	08-	0,70	CR8E	1275	04	CR8EIX	4218



TM

80	1	Cross & Enduro	94-	0,60	BR9EG	3230	-	-	-
125	1	Cross & Enduro	94-	0,60	BR9EG	3230	-	-	-
125	1	EN	03-	0,60	BR9EG	3230	-	-	-
125	1	MX Racing 2 Temps	05-	0,60	BR9EG	3230	-	-	-
250	1	Cross & Enduro	94-	0,60	BR8EG	3130	-	-	-
250		EN Cross & Enduro 4 Temps	01-	0,70	CR8E	1275	04	CR8EIX	4218
250	1	EN	03-	0,60	BR8EG	3130	-	-	-
250	1	EN EN-F	03-	0,70	CR8E	1275	04	CR8EIX	4218
250	1	EN 4 Temps	05-	0,70	CR8E	1275	04	CR8EIX	4218
250	1	EN 2 Temps	05-	0,60	BR8EG	3130	-	-	-
300		Cross & Enduro	94-	0,60	BR9EG	3230	-	-	-
300	1	EN	03-	0,60	BR8EG	3130	-	-	-
400		Cross & Enduro 4 Temps	02-	0,70	CR8E	1275	04	CR8EIX	4218
450	1	EN-F	03-	0,70	CR8E	1275	04	CR8EIX	4218
450	1	EN 4 Temps	05-	0,70	CR8E	1275	04	CR8EIX	4218
450		MX Racing 4 Temps	05-	0,70	CR8E	1275	04	CR8EIX	4218
530		EN 4 Temps	05-	0,70	CR8E	1275	04	CR8EIX	4218
530		MX Racing 4 Temps	05-	0,70	CR8E	1275	04	CR8EIX	4218



TRAILBLAZER

50	1	50	-	0,70	BP7HS	5111	14	BPR7HIX	5944
50	1	Mini	-	0,70	BPR7HS	6422	14	BPR7HIX	5944
90	1	2 Temps	-	0,70	BP7HS	5111	14	BPR7HIX	5944
90	1	4 Temps	-	0,70	CR7HSA	4549	07	CR7HIX	7544
170		170	04-	0,70	DR8EA	7162	11	DR8EIX	6681
250		250	-	0,80	CR8HSA	2086	-	CR8HIX	7669



TRAILSPORT

500	1	TS-500 5.0hp	04-	0,60	BR2-LM	5798	-	-	-
600	1	TSB-600 6.0hp	04-	0,60	BR2-LM	5798	-	-	-



TRITON





280	1	Baja 300 R / Limited	-	0,90	DPR7EA-9	5129	13	DPR7EIX-9	7803
280	1	Outback 300 / 300 White Desert	-	0,90	DPR7EA-9	5129	13	DPR7EIX-9	7803



TRIUMPH

250		Twins with 3/4"	-	0,60	B8ES	2411	05	BR8EIX	5044
600	4	Daytona 600	04-	0,70	CR9EK	4548	-	CR9EIX	3521

TRIUMPH

CYL.	Nb Cyl.	TYPE	MODÈLE		INFO			N° STOCK	N° BLISTER		N° STOCK IX
600	4		Speed Triple S / Speed Four	02-		0,70	CR9EK	4548	-	CR9EIX	3521
600	4	TT	Supersport	00-		0,70	CR9EK	4548	-	CR9EIX	3521
650	4		Daytona	05-		0,70	CR9EK	4548	-	CR9EIX	3521
675	3		Daytona	06-		0,70	CR9EK	4548	-	CR9EIX	3521
675	3		Daytona	13-		0,90	CR9EIA-9	6289	-	-	-
675	3		Daytona R	-		0,70	CR9EK	4548	-	CR9EIX	3521
675	3		Daytona R	13-		0,90	CR9EIA-9	6289	-	-	-
675	3		Street Triple	-		0,70	CR9EK	4548	-	CR9EIX	3521
675	3		Speed Triple R	08-		0,70	CR9EK	4548	-	CR9EIX	3521
750			Bonneville T140D/E	-		0,50	B6ES	7310	-	-	-
750			Hurricane TRX75, Tiger TR7RV, TR7V	-		0,50	B8ES	2411	05	BR8EIX	5044
750			TSX8, TSS	-		0,60	C8E	7471	04	CR8EIX	4218
750			Trident T150V, T160	-		0,50	B8ES	2411	05	BR8EIX	5044
750	3		Trident, Daytona	91-98		0,90	DPR9EA-9	5329	-	DPR9EIX-9	5545
790	2		America	05-		0,90	DPR8EA-9	4929	08	DPR8EIX-9	2202
790	2		Bonneville T100 / America, Speedmaster	01-		0,90	DPR8EA-9	4929	08	DPR8EIX-9	2202
790	2		Tiger	91-98		0,90	DPR8EA-9	4929	08	DPR8EIX-9	2202
800	2		Bonneville	01-		0,90	DPR8EA-9	4929	08	DPR8EIX-9	2202
800	3		Tiger, Tiger XC	10-		0,70	CR9EK	4548	-	CR9EIX	3521
800	3	XRT	Tiger XRT	17-		0,70	CR9EK	4548	-	CR9EIX	3521
865	2		America	07-		0,90	DPR8EA-9	4929	08	DPR8EIX-9	2202
865	2		America LT	-		0,90	DPR8EA-9	4929	08	DPR8EIX-9	2202
865	2		Bonneville	07-		0,90	DPR8EA-9	4929	08	DPR8EIX-9	2202
865	2		Bonneville T100	05-		0,90	DPR8EA-9	4929	08	DPR8EIX-9	2202
865	2		Scrambler	06-		0,90	DPR8EA-9	4929	08	DPR8EIX-9	2202
865	2		Speedmaster	05-		0,90	DPR8EA-9	4929	08	DPR8EIX-9	2202
865	2		Thrupton 900 / SE	04-		0,90	DPR8EA-9	4929	08	DPR8EIX-9	2202
885	3		Thunderbird	95-04		0,90	DPR8EA-9	4929	08	DPR8EIX-9	2202
885			T509 Speed Triple	96-98		0,90	DPR8EA-9	4929	08	DPR8EIX-9	2202
885			T709 Tiger	98-		0,90	DPR8EA-9	4929	08	DPR8EIX-9	2202
900	3		Adventurer	96-		0,90	DPR8EA-9	4929	08	DPR8EIX-9	2202
900			Daytona / Super III	91-96		0,90	DPR9EA-9	5329	-	DPR9EIX-9	5545
900	3		Legend TT	00-		0,90	DPR8EA-9	4929	08	DPR8EIX-9	2202
900	2		Scrambler	06-		0,90	DPR8EA-9	4929	08	DPR8EIX-9	2202
900	2		Speedmaster	05-		0,90	DPR8EA-9	4929	08	DPR8EIX-9	2202
900	3		Speed Triple	94-97		0,90	DPR9EA-9	5329	-	DPR9EIX-9	5545
900			Sprint, Executive, Sport	-		0,90	DPR9EA-9	5329	-	DPR9EIX-9	5545
900	3		Thunderbird	95-		0,90	DPR9EA-9	5329	-	DPR9EIX-9	5545
900	3		Thunderbird Sport	00-		0,90	DPR9EA-9	5329	-	DPR9EIX-9	5545
900	2		Thrupton	04-		0,90	DPR8EA-9	4929	08	DPR8EIX-9	2202
900	3		Tiger	93-00		0,90	DPR9EA-9	5329	-	DPR9EIX-9	5545
900	3		Trident, Trophy	91-		0,90	DPR9EA-9	5329	-	DPR9EIX-9	5545
955	3		i Daytona	01-		0,70	CR9EK	4548	-	CR9EIX	3521
955	3		i Tiger	01-		0,90	DPR9EA-9	5329	-	DPR9EIX-9	5545
955	3		i Sprint ST / RS	99-		0,90	DPR9EA-9	5329	-	DPR9EIX-9	5545
955	3	T509	i Speed Triple	98-		0,90	DPR9EA-9	5329	-	DPR9EIX-9	5545
955	3	T595	Daytona	97-99		0,90	DPR9EA-9	5329	-	DPR9EIX-9	5545
955	3	T595	i Daytona / Centenary	00-		0,90	DPR9EA-9	5329	-	DPR9EIX-9	5545
1000			Daytona	91-		0,90	DPR9EA-9	5329	-	DPR9EIX-9	5545
1050	3		HM	07-		0,70	CR9EK	4548	-	CR9EIX	3521
1050	3		Speed Triple	05-		0,70	CR9EK	4548	-	CR9EIX	3521
1050	3		Tiger	06-		0,70	CR9EK	4548	-	CR9EIX	3521
1050	3		Tiger Sport	13-		0,70	CR8EK	3478	-	CR8EIX	4218
1050	3	ST	Sprint, ABS	05-		0,70	CR9EK	4548	-	CR9EIX	3521
1050	3	GT	Sprint	10-		0,70	CR8EK	3478	-	CR8EIX	4218
1200	4		Daytona	92-		0,90	DPR9EA-9	5329	-	DPR9EIX-9	5545
1200	3		Tiger Explorer	12-		0,70	CR8EK	3478	-	CR8EIX	4218
1200	4		Trophy	91-		0,90	DPR9EA-9	5329	-	DPR9EIX-9	5545
1200	3		Trophy (Incl. SE)	12-		0,70	CR8EK	3478	-	CR8EIX	4218
1600	2		Thunderbird	10-		0,90	DPR6EA-9	5531	-	-	-
2300	3		Rocket III GT	07-		0,90	DPR8EA-9	4929	08	DPR8EIX-9	2202
2300	3		Rocket III	04-	2 Bougies par Cylindre	0,90	DPR8EA-9	4929	08	DPR8EIX-9	2202

UNILLI

150	1		KX 150	05-		0,60	CR7E	4578	12	CR7EIX	7385
-----	---	--	--------	-----	--	------	------	------	----	--------	------

UNITED MOTORS

50	1		Dirt Squirt	-		0,60	BR8HS	4322	01	BR8HIX	7001
50	1		Monntrax	-		0,80	BPR7HS	6422	14	BPR7HIX	5944
90	1		Dirt Squirt	-		0,60	BR8HS	4322	01	BR8HIX	7001
90	1		Earthlander	-		0,80	BPR7HS	6422	14	BPR7HIX	5944
90	1		Moontrax	-		0,60	BPR7HS	6422	14	BPR7HIX	5944
90	1		Reptile	-		0,70	C7HSA	4629	07	CR7HIX	7544



UNISOM

50	1		Desert-Cat 50	04-	0,60	BR8HS	4322	01	BR8HIX	7001
90	1		Desert-Cat 90	04-	0,60	BR8HS	4322	01	BR8HIX	7001



URAL RETRO

648			Cruiser, Classic	97-	0,60	BP4HS	3611	-	-	-
650			IMZ-10 / 40 / 50	-	0,60	BP4HS	3611	-	-	-
650			Solo Single, Sportsman	94-96	0,60	BP4HS	3611	-	-	-
650			M3-8.123	-	0,70	BP6ES	7811	-	BPR6EIX	6637
745	2			-	0,50	BP7HS	5111	14	BPR7HIX	5944



V.O.R.

400	1	EN	Enduro	00-	0,60	CR7EK	7546	-	CR7EIX	7385
400	1	MX	Cross	00-	0,60	CR7EK	7546	-	CR7EIX	7385
400	1	SM	Super Motard	00-	0,60	CR7EK	7546	-	CR7EIX	7385
450	1	EN	Enduro	00-	0,60	CR7EK	7546	-	CR7EIX	7385
450	1		EN-MAR, ENE	04-	0,70	CR8EK	3478	-	CR8EIX	4218
450	1	MX	Cross	00-	0,60	CR7EK	7546	-	CR7EIX	7385
500	1	C	Cross	02-	0,70	CR8EK	3478	-	CR8EIX	4218
501	1	E	Enduro	02-	0,70	CR8EK	3478	-	CR8EIX	4218
501	1	S	Super Motard	02-	0,70	CR8EK	3478	-	CR8EIX	4218
503	1	SM	Super Motard	99-	0,60	CR7EK	7546	-	CR7EIX	7385
530	1	EN	Enduro	99-	0,60	CR7EK	7546	-	CR7EIX	7385
530	1	ENE	EN-MAR	04-	0,70	CR8EK	3478	-	CR8EIX	4218
530	1	MX	Cross	01-	0,60	CR7EK	7546	-	CR7EIX	7385
530	1	SM	Super Motard Compétition	99-	0,60	CR7EK	7546	-	CR7EIX	7385



VELOSOLEX

50	1		2200, 3300, 3800, 5000, 6000	-	0,50	B-4H	4110	-	-	-
50	1		8000, GS Ténor, GL Ténor, GR Ténor	-	0,50	B6HS	4510	09	BR6HIX	3419
50	1		Micron, Pli-solex	-	0,50	B-4H	4110	-	-	-
50	1		Ténor L/R/S	-	0,50	B6ES	7310	-	-	-



VENTO

100	1		Avalanche EX100	-	0,70	BPR6HS	7022	-	BPR6HIX	4085
250			Rhino 250	-	0,70	DR8EA	7162	11	DR8EIX	6681



VERTEMATI

500	1	C	Cross	02-	0,70	CR8EK	3478	-	CR8EIX	4218
500		SR	501	-	0,70	CR9EK	4548	-	CR9EIX	3521
501	1	E	Enduro	02-	0,70	CR8EK	3478	-	CR8EIX	4218
501	1	S	Super Motard	02-	0,70	CR8EK	3478	-	CR8EIX	4218
503	1		E 450 / E, E 501 / E, E 570 / E	-	0,70	CR9EK	4548	-	CR9EIX	3521
570		S	570	03-	0,70	CR9EK	4548	-	CR9EIX	3521



VICTORY

1507			V92C and all 92 cu.Inch models	99-01	1,00	DCPR6E	3481	-	DCPR6EIX	8196
1507			V92C and all 92 cu.Inch models	02-04	0,80	CPR6EB-9	5958	-	-	-
1634	2		Hammer, Kingpin, Touring Cruiser	06-	0,90	CPR6EB-9	5958	-	-	-
1634	2		Vegas, Jackpot, 8-Ball	06-	0,90	CPR6EB-9	5958	-	-	-
1700	2		Cross Country	11-	0,90	DCPR6E	3481	-	DCPR6EIX	8196
1700	2		Hammer, 8-Ball, Jackpot, S Suede	11-	0,90	DCPR6E	3481	-	DCPR6EIX	8196
1700	2		Vision Tour ABS, Zach Ness Cross Vegas SL	11-	0,90	DCPR6E	3481	-	DCPR6EIX	8196
1731			Arlen Ness Vision, Cory Ness Jackpot	10-	0,80	DCPR6E	3481	-	DCPR6EIX	8196
1731	2		Broadwalk	13-	0,80	DCPR6E	3481	-	DCPR6EIX	8196
1731	2		Cross Country / Country Tour, Cross Roads	10-	0,80	DCPR6E	3481	-	DCPR6EIX	8196
1731	2		Jackpot, Vision 8-Ball	10-	0,80	DCPR6E	3481	-	DCPR6EIX	8196
1731	2		Hammer S	11-	0,90	DCPR6E	3481	-	DCPR6EIX	8196





VINSON





150	1		ETV 4 Temps	-	0,60	C7HSA	4629	07	CR7HIX	7544
250			ETV 4 Temps	-	0,60	C7HSA	4629	07	CR7HIX	7544









YAMAHA



50	1	Beluga	-	1,00	BP7HS-10	7829	-	-	-
50	1	Jog	90-	0,70	BPR6HS	7022	-	BPR6HIX	4085
50	1	JogR, JogRR	-	0,60	BR8HS	4322	01	BR8HIX	7001
50	1	Jog-Z 50	95-	0,70	BP7HS	5111	14	BPR7HIX	5944
50	1	LB, Chappy	-	0,60	B6HS	4510	09	BR6HIX	3419
50	1	Meyami	86-	0,70	BR7HS	4122	03	BR7HIX	7067
50	1	Slider	99-	0,60	BR9HS	4522	-	BR9HIX	5687
50	1	Why	98-00	0,70	BR8HS	4322	01	BR8HIX	7001
50	1	BA N / NH / S	07	0,70	BR7HS	4122	03	BR7HIX	7067
50	1	BW's Bump	96-	0,70	BR8HS	4322	01	BR8HIX	7001
50	1	BW's CW50	92-	0,70	BR8HS	4322	01	BR8HIX	7001
50	1	BW's Original / NG / R	96-	0,70	BR8HS	4322	01	BR8HIX	7001
50	1	BW's R 12	01-	0,70	BR8HS	4322	01	BR8HIX	7001
50	1	BW's Spy	96-	0,70	BR8HS	4322	01	BR8HIX	7001
50	1	BX / N	07	0,70	CR8E	1275	04	CR8EIX	4218
50	1	BX S	08	0,70	CR8E	1275	04	CR8EIX	4218
50	1	CE / D	07-09	0,80	CR7E	4578	12	CR7EIX	7385
50	1	CE ZR	09	0,70	CR7E	4578	12	CR7EIX	7385
50	1	CR Z	-	0,50	BR7HS	4122	03	BR7HIX	7067
50	1	CS / Z	09	0,70	BR8HS	4322	01	BR8HIX	7001
50	1	CT S	-	1,00	BP7HS-10	7829	-	-	-
50	1	CT SS	-	0,70	BP7HS	5111	14	BPR7HIX	5944
50	1	CV / A / R / Z2 / ZR	07	0,60	BPR7HS	6422	14	BPR7HIX	5944
50	1	CW / L / N	07-09	0,70	BR8HS	4322	01	BR8HIX	7001
50	1	CW LN	08-09	0,70	BR8HS	4322	01	BR8HIX	7001
50	1	CW R	-	0,70	BR8HS	4322	01	BR8HIX	7001
50	1	CW RS	09	0,70	BR8HS	4322	01	BR8HIX	7001
50	1	CW RSP	08-09	0,70	BR8HS	4322	01	BR8HIX	7001
50	1	DT A	87-	0,70	BR6HS	3922	09	BR6HIX	3419
50	1	DT RM	97-	0,80	BR8ES	5422	05	BR8EIX	5044
50	1	EW N	07-09	0,70	BR8HS	4322	01	BR8HIX	7001
50	1	PW	90-	0,70	BPR4HS	7823	-	-	-
50	1	PW	08-	0,70	BP4HS	3611	-	-	-
50	1	SH	-	1,00	BPR6HS-10	2633	-	-	-
50	1	TT-R E / EX / EY	07-	0,70	CR7HSA	4549	07	CR7HIX	7544
50	1	TY M	-	0,60	B7HS	5110	03	BR7HIX	7067
50	1	TZR	03-12	0,80	BR9ES	5722	02	BR9EIX	3981
50	1	TZR	13-	0,70	CR8E	1275	04	CR8EIX	4218
50	1	TZR R	97-	0,80	BR8ES	5422	05	BR8EIX	5044
50	1	V FM	-	0,60	B7HS	5110	03	BR7HIX	7067
50	1	V MA	-	0,60	B6HS	4510	09	BR6HIX	3419
50	1	XC V Vino	06-	0,70	CR7E	4578	12	CR7EIX	7385
50	1	XF Giggle	07-	0,80	CR7E	4578	12	CR7EIX	7385
50	1	YE Zest	92-	0,70	BR7HS	4122	03	BR7HIX	7067
50	1	YM Breeze	-	0,70	BR8HS	4322	01	BR8HIX	7001
50	1	YN Neo's	97-07	0,60	BR8HS	4322	01	BR8HIX	7001
50	1	YN Neo's 4 Temps	09-	0,80	CR7E	4578	12	CR7EIX	7385
50	1	YN R Neo's	-	0,70	BR7HS	4122	03	BR7HIX	7067
50	1	YQ Aerox / R "Biaggi", Nitro	97-	0,70	BR8HS	4322	01	BR8HIX	7001
50	1	YQ Aerox R Toyota Racing	03-	0,60	BR8HS	4322	01	BR8HIX	7001
50	1	YW ZUMA	08-	0,70	BPR7HS	6422	14	BPR7HIX	5944
50	1	YZ H	-	0,60	B9ES	2611	02	BR9EIX	3981
50	1	ZE Zest	93-96	0,60	BR7HS	4122	03	BR7HIX	7067
60	1	YF S	-	0,70	BP6HS	4511	-	BPR6HIX	4085
70	1	V	-	0,70	B7HS	5110	03	BR7HIX	7067
80	1	PW K	-	0,60	BP6HS	4511	-	BPR6HIX	4085
80	1	TY B	-	0,60	B6HS	4510	09	BR6HIX	3419
80	1	YE Zest	-	0,70	BR7HS	4122	03	BR7HIX	7067
80	1	YFM Badger	-	0,70	CR7HSA	4549	07	CR7HIX	7544
80	1	YFM S / T	85-	0,60	CR7HSA	4549	07	CR7HIX	7544
80	1	YSR	-	0,60	BR8HS	4322	01	BR8HIX	7001
80	1	YZ S	86-	0,60	BR9EG	3230	-	-	-
80	1	YZ B	-	0,70	B8HS	5510	01	BR8HIX	7001
80	1	YZ E / F / G / H / H1 / LW / LWF / LWH / LWG	94-96	0,60	B10EG	3630	-	-	-
80	1	YZ J / K / L / N / T	-	0,60	B9EG	3530	-	-	-
80	1	YZ LC	99-	0,60	BR10EG	3830	-	-	-
85	1	YZ	01-	0,60	BR10EG	3830	-	-	-
85	1	YZ W1 / X	07-	0,60	BR10EG	3830	-	-	-
90	1	TT-R	00-	0,70	CR6HSA	2983	-	CR6HIX	7274
90	1	T D / N	07	0,70	CR6HSA	2983	-	CR6HIX	7274
90	1	V	-	0,70	B7HS	5110	03	BR7HIX	7067
100	1	AG H	-	0,70	B7ES	1111	-	BR7EIX	6664

CYL.	Nb Cyl.	TYPE	MODÈLE		INFO			N° STOCK	N° BLISTER		N° STOCK IX
100	1	BW		99-00		0,60	BR8HS	4322	01	BR8HIX	7001
100	1	BW		00-		0,70	BR7HS	4122	03	BR7HIX	7067
100	1	BW's		00-		1,00	BPR7HS-10	1092	-	-	-
100		DT	B	-		0,50	B8HS	5510	01	BR8HIX	7001
100		DT	C / X	-		0,50	B7ES	1111	-	BR7EIX	6664
100		DT	D / SD / E	-		0,50	B8ES	2411	05	BR8EIX	5044
100		RS	B/X/DX/S	-		0,50	B8HS	5510	01	BR8HIX	7001
100		RS	P	-		0,50	BP6HS	4511	-	BPR6HIX	4085
100	1	RT	G / H	-		0,70	B7ES	1111	-	BR7EIX	6664
100	1	YN	Neo's	00-		1,00	BR8HS-10	1134	-	-	-
100	1	YQ	Aerox	00-		1,00	BR8HS-10	1134	-	-	-
100		YZ	H	-		0,50	B8EG	3430	-	-	-
100		YZ	K	-		0,50	B9EG	3530	-	-	-
100		YZ	L	-		0,60	BR9EG	3230	-	-	-
110	1	TT-R	EX, EY	09-		0,70	CR6HSA	2983	-	CR6HIX	7274
115	1	AF	C, S	07-08		0,70	C7HSA	4629	07	CR7HIX	7544
115	1	AL	C,F,S	07-09		0,70	C7HSA	4629	07	CR7HIX	7544
115	1	AT	C	07-09		0,80	CR7HSA	4549	07	CR7HIX	7544
125			Black X-max	09-		0,90	CPR9EA-9	2308	-	-	-
125	1	BW's	Culot court	09-		0,70	CR7HSA	4549	07	CR7HIX	7544
125	1	BW's	Culot long	10-		0,60	CR7E	4578	12	CR7EIX	7385
125	1		Vity	08-		0,60	CR7E	4578	12	CR7EIX	7385
125	1	DT	MX	-		0,80	B8ES	2411	05	BR8EIX	5044
125	1	DT		88-		0,80	BR9ES	5722	02	BR9EIX	3981
125	1	DT	E, ED, F, H, MX	-		0,80	B8ES	2411	05	BR8EIX	5044
125	1	DT	LC	-		0,60	BR9ES	5722	02	BR9EIX	3981
125	1	DT	X	05-		0,50	BR8ES	5422	05	BR8EIX	5044
125	1	DT	R, RE	90-		0,70	BR9ES	5722	02	BR9EIX	3981
125	1	DT	RE	04-		0,80	BR8ES	5422	05	BR8EIX	5044
125		HW	Xenter	12-		0,90	CPR9EA-9	2308	-	-	-
125		NXC	XC125 Cygnus X	04-		0,80	CR7E	4578	12	CR7EIX	7385
125	1	RD	C-DX, DX, D-DX	-		0,80	B8ES	2411	05	BR8EIX	5044
125	1	RD	Culot court	-		0,70	B8HS	5510	01	BR8HIX	7001
125	1	RD	Culot long	-		0,80	B8ES	2411	05	BR8EIX	5044
125	1	RS	E	-		0,70	B7HS	5110	03	BR7HIX	7067
125	1	RS	Z / DX	-		0,70	B8HS	5510	01	BR8HIX	7001
125	1	SR	SE	-95		0,70	D8EA	2120	11	DR8EIX	6681
125	1	SR		96-		0,70	DR8EA	7162	11	DR8EIX	6681
125		T	H / J	-		0,60	B9EG	3530	-	-	-
125	1	TDR		92-96		0,80	BR9ES	5722	02	BR9EIX	3981
125	1	TDR		97-		0,80	BR8ES	5422	05	BR8EIX	5044
125	1	TT-R	LW (petites & grandes roues)	00-		0,70	CR7HSA	4549	07	CR7HIX	7544
125	1	TTR	EX, LEX, LX	08-		0,70	CR7HSA	4549	07	CR7HIX	7544
125	1	TW		98-		0,70	DR8EA	7162	11	DR8EIX	6681
125	1	TY	culot court	-		0,70	B7HS	5110	03	BR7HIX	7067
125	1	TZ	H	-95		0,60	-	-	-	BR10EIX	6801
125	1	TZ	H	95-		0,60	R7376-10	4457	-	-	-
125	1	TZR		93-		0,80	BR9ECM	3252	-	BR9ECMIX	2707
125		VP	X-City	07-		0,90	CPR9EA-9	2308	-	-	-
125	1	WR		97-		0,60	BR9EG	3230	-	-	-
125	1	WR	R Enduro / X Supermotard	09-		0,70	CR8E	1275	04	CR8EIX	4218
125	1	XC	(3TE)	90-		0,70	CR6HSA	2983	-	CR6HIX	7274
125	1	XC	B/E/F/G/H/X/W/ZW	-		0,70	C6HSA	3228	-	CR6HIX	7274
125	1	XC	S / SC / ZSC / ZS, Beluga	-		0,70	CR6HSA	2983	-	CR6HIX	7274
125	1	XC	Cygnus	95-		0,70	CR7E	4578	12	CR7EIX	7385
125	1	XC	T (4KY)	95-		0,60	CR7E	4578	12	CR7EIX	7385
125	1	XC	T (4NB)	94-		0,70	CR7E	4578	12	CR7EIX	7385
125	1	XC	T Cygnus T (4NB)	96-		0,60	CR7E	4578	12	CR7EIX	7385
125	1	XC	TR Cygnus, R	96-99		0,70	CR7E	4578	12	CR7EIX	7385
125	1	XC	TR Cygnus	00-		0,70	CR7E	4578	12	CR7EIX	7385
125	1	XC	X Cygnus	07-		0,70	CR7E	4578	12	CR7EIX	7385
125	1	XN	Teo's	00-		0,60	CR8E	1275	04	CR8EIX	4218
125	1	XQ	Maxster, Thunder	01-		0,60	CR8E	1275	04	CR8EIX	4218
125	1	XT	J/ K/ KC/ L	-		0,70	D8EA	2120	11	DR8EIX	6681
125	1	XT	E, EC, F, FC	93-		0,70	DR8EA	7162	11	DR8EIX	6681
125	1	XT	R / X	05-		0,80	CR7HSA	4549	07	CR7HIX	7544
125	1	XV	Virago	97-		0,70	CR6HSA	2983	-	CR6HIX	7274
125	1	XVS	DragStar	00-		0,70	CR7HSA	4549	07	CR7HIX	7544
125		Y	E / F	-		0,50	BR9EG	3230	-	-	-
125	1	YBR		05-		0,70	CR6HSA	2983	-	CR6HIX	7274
125	1	YBR	Custom	10-		0,70	CR6HSA	2983	-	CR6HIX	7274
125	1	YFA	1 Breeze	-		0,70	CR7HSA	4549	07	CR7HIX	7544
125	1	YJ	V Vino	06-		0,70	CR7E	4578	12	CR7EIX	7385
125	1	YP	Majesty	04-		0,70	CR7E	4578	12	CR7EIX	7385
125	1	YP	Majesty	07-		0,70	CR8E	1275	04	CR8EIX	4218
125	1	YP	R Majesty	98-		0,70	CR8E	1275	04	CR8EIX	4218

CYL.	Nb Cyl.	TYPE	MODÈLE		INFO			N° STOCK	N° BLISTER		N° STOCK IX
125	1	YP	X-Max R	06-		0,90	CPR9EA-9	2308	-	-	-
125	1	YS		13-		-	-	-	-	BR9EIX	3981
125	1	YT	N	85-		0,60	BP5ES	6511	-	BPR5EIX	6597
125	1	YZ	A, U, W, N, S, E, E1, F, LC	-		0,60	BR9EG	3230	-	-	-
125	1	YZ	B, C, G, G1, H, X	-		0,60	B9EG	3530	-	-	-
125	1	YZ	S1 / T1	04-		0,60	BR9EG	3230	-	-	-
125	1	YZ	X1	08-		0,70	-	-	-	BR9EIX	3981
125	1	YZ	W1	07-		0,60	-	-	-	BR9EIX	3981
125		YZF	R	08-		0,70	CR8E	1275	04	CR8EIX	4218
135	1	JT		07-08		0,90	CPR8EA-9	2306	-	-	-
135	1	T	HC / S / SE / SEC	07-09		0,90	CPR8EA-9	2306	-	-	-
150	1	XC	Fly One	95-		0,70	CR7E	4578	12	CR7EIX	7385
153			AC 150 B	09-		0,90	CPR8EA-9	2306	-	-	-
175	1	DT	E, MX	-		0,80	B8ES	2411	05	BR8EIX	5044
175	1	IT	E	-		0,60	-	-	-	BR10EIX	6801
175	1	IT	H / J / K	-		0,60	B9EG	3530	-	-	-
175	1	TY	E, J	-		0,80	B7ES	1111	-	BR7EIX	6664
200			CSSE	-		0,60	B8HS	5510	01	BR8HIX	7001
200	1	DT	R	-		0,80	BR9ES	5722	02	BR9EIX	3981
200	1	IT		-		0,60	BR9EG	3230	-	-	-
200	1	RD	B culot court	-		0,70	B8HS	5510	01	BR8HIX	7001
200	1	RD	B culot long	-		0,80	B7ES	1111	-	BR7EIX	6664
200	1	RD	Tous modèles sauf B	-		0,80	B8ES	2411	05	BR8EIX	5044
200	1	RS		-		0,80	B8ES	2411	05	BR8EIX	5044
200	1	TW	E / EC / F	87-		0,70	DR8EA	7162	11	DR8EIX	6681
200	1	TW	X	08-		0,70	DR8EA	7162	11	DR8EIX	6681
200	1	WR	B/R/RD/RE/RG/RH	-		0,60	BR9ES	5722	02	BR9EIX	3981
200	1	YFM	DX	-		0,70	DR7ES	3123	-	DR7EIX	5686
200	1	YFM	N (Moto-4)	-		0,70	D7EA	7912	-	DR7EIX	5686
200	1	YFS	Blaster	-		0,80	BR8ES	5422	05	BR8EIX	5044
200	1	YTM	K/EK/L/EL/ERN/N	-		0,70	D7EA	7912	-	DR7EIX	5686
225	1	TT		-		0,70	DR8ES-L	2923	-	DR8EIX	6681
225	1	YFM	S (Moto-4)	-		0,70	D7EA	7912	-	DR7EIX	5686
240	1	TDR		-		0,80	BR9ES	5722	02	BR9EIX	3981
240	1	XV		-		0,70	CR6HS	7023	-	-	-
250	1		Grand Majesty	04-		0,90	CPR6EA-9	6899	-	-	-
250	2		V Star 250	12-		0,70	C6HSA	3228	-	CR6HIX	7274
250	1		X-City	07-		0,90	DPR8EA-9	4929	08	DPR8EIX-9	2202
250	1		X-Max	05-06		0,60	DR8EA	7162	11	DR8EIX	6681
250	1		X-Max	07-		0,90	DPR8EA-9	4929	08	DPR8EIX-9	2202
250	1	CP	W Morphous	07-		0,90	CPR7EA-9	3901	-	CPR7EIX-9	9198
250	1	DT	E, MX	-		0,80	B8ES	2411	05	BR8EIX	5044
250		IT	H	-		0,60	B9EG	3530	-	-	-
250		MX		-		0,60	-	-	-	BR8EIX	5044
250	2	RD	LC	-		0,80	BR8ES	5422	05	BR8EIX	5044
250	2	RD	Culot court	-		0,70	B8HS	5510	01	BR8HIX	7001
250	2	RD	Culot long	-		0,80	B9ES	2611	02	BR9EIX	3981
250	2	RD	D, H, J	-		0,80	B8ES	2411	05	BR8EIX	5044
250	1	SR		-		0,80	BPR7ES	2023	-	BPR7EIX	4055
250	2	TDR		-		0,80	BR9ES	5722	02	BR9EIX	3981
250	1	TTR		94-99		0,80	CR9E	6263	06	CR9EIX	3521
250	1	TTR	R	00-		0,80	CR9E	6263	06	CR9EIX	3521
250	1	TY	N	-		0,60	BR8ES	5422	05	BR8EIX	5044
250	1	TY	R	-		0,80	BR6ES	4922	-	-	-
250	1	TY	Z	94-95		0,60	-	-	-	BPR6EIX	6637
250	1	TY	Z	96-		0,60	-	-	-	BPR6EIX	6637
250	2	TZR	A, T	-		0,80	BR9ES	5722	02	BR9EIX	3981
250	2	TZR	R, RS, RSP	-		0,80	BR9ECM	3252	-	BR9ECMIX	2707
250		VP	X-City	07-		0,90	DPR8EA-9	4929	08	DPR8EIX-9	2202
250	1	WR		97-		0,60	BR8EG	3130	-	-	-
250	1	WR	Z / ZB / ZG / ZF	-		0,60	B8EG	3430	-	-	-
250	1	WR	ZH	-		0,60	BR8EG	3130	-	-	-
250	1	WR	F	01-		0,70	CR8E	1275	04	CR8EIX	4218
250	1	WR	FX	08-		0,70	CR8E	1275	04	CR8EIX	4218
250	1	WR	R / X / RY / RYC / XY / XYC	08-		0,80	CR9EK	4548	-	CR9EIX	3521
250	1	XG	Tricker	05-		0,70	DR7EA	7839	-	DR7EIX	5686
250	2	XS	C, H, RH, SE, SH	-		0,80	BP7ES	2412	-	BPR7EIX	4055
250	2	XS	PK, SK, R	-		0,70	D8EA	2120	11	DR8EIX	6681
250	1	XT		07-09		0,60	DR7EA	7839	-	DR7EIX	5686
250	1	XTZ		07-09		0,70	DR8EA	7162	11	DR8EIX	6681
250	2	XV	S / SG (Virago)	95-		0,60	CR6HS	7023	-	-	-
250	2	XV	Virago	08-		0,70	C6HSA	3228	-	CR6HIX	7274
250	2	XV	W, WC	-		0,70	CR6HSA	2983	-	CR6HIX	7274
250		XVS	Drag Star	01-		0,70	CR6HSA	2983	-	CR6HIX	7274
250		YBR		07-		0,60	DR8EA	7162	11	DR8EIX	6681
250	1	YP		00-		0,60	DR8EA	7162	11	DR8EIX	6681

CYL.	Nb Cyl.	TYPE	MODÈLE		INFO			N° STOCK	N° BLISTER		N° STOCK IX
250	1	YP	Black X-Max	07-	0,90		DPR8EA-9	4929	08	DPR8EIX-9	2202
250	1	YP	Black X-Max	10-	0,60		DR8EA	7162	11	DR8EIX	6681
250	1	YP	Grand Majesty	04-	0,90		CPR7EA-9	3901	-	CPR7EAI-X-9	9198
250	1	YP	Majesty DX	97-00	0,60		DR8EA	7162	11	DR8EIX	6681
250	1	YP	A Majesty, ABS	00-	0,70		DR8EA	7162	11	DR8EIX	6681
250	1	YP	R Black X-max	09-	0,90		DPR8EA-9	4929	08	DPR8EIX-9	2202
250	1	YP	R X-Max	05-09	0,70		DR8EA	7162	11	DR8EIX	6681
250	1	YP	R X-Max	10-	0,70		CR7E	4578	12	CR7EIX	7385
250		YTZ	N/S	85-	0,60		B8ES	2411	05	BR8EIX	5044
250	1	YZ	4MX	95-	0,70		BR8EG	3130	-	-	-
250	1	YZ	A/E/U/W/WR/WRA/WRW	-	0,60		B8EG	3430	-	-	-
250	1	YZ	F/W1	07-	0,60		BR8EG	3130	-	-	-
250	1	YZ	FX	08-	0,70		CR8E	1275	04	CR8EIX	4218
250	1	YZ	G/G1	95-	0,50		B8EG	3430	-	-	-
250	1	YZ	H/H1	96-	0,60		BR8EG	3130	-	-	-
250	1	YZ	N	-	0,60		B9EG	3530	-	-	-
250	1	YZ	LC	99-	0,60		BR8EG	3130	-	-	-
250	1	YZ	F	01-	0,80		CR8E	1275	04	CR8EIX	4218
250	1	YZ	F/FS	04-	0,80		CR8E	1275	04	CR8EIX	4218
250	1	YZ	F	13-	0,80		LMAR8G	95627	-	-	-
250	1	YZ	S1/T1	04-	0,60		BR8EG	3130	-	-	-
250	1	YZ	X	08-	0,60		BR8EG	3130	-	-	-
300	2	VP	Versity	03-	0,90		DR8EA	7162	11	DR8EIX	6681
350	2	RD	Culot court	-	0,70		B8HS	5510	01	BR8HIX	7001
350	2	RD	Culot long	-	0,80		B8ES	2411	05	BR8EIX	5044
350	2	RD	F/LCF/N	86-	0,80		BR9ES	5722	02	BR9EIX	3981
350		TT		-	0,70		D8EA	2120	11	DR8EIX	6681
350		XT		-	0,70		DR8ES-L	2923	-	DR8EIX	6681
350	1	YFM	ERT, FWT, XT	87-	0,60		D8EA	2120	11	DR8EIX	6681
350		YFZ	T	87-	0,60		B8ES	2411	05	BR8EIX	5044
400	1		Majesty	01-	0,70		CR7E	4578	12	CR7EIX	7385
400		DT	E, MX	-	0,80		B8ES	2411	05	BR8EIX	5044
400		FZR	RR/SP	91-95	0,70		CR8E	1275	04	CR8EIX	4218
400		IT		-	0,80		B8ES	2411	05	BR8EIX	5044
400		MX		-	0,60		-	-	-	BR8EIX	5044
400	2	RD	C/D	-	0,80		B8ES	2411	05	BR8EIX	5044
400		WR	F	98-	0,70		CR8E	1275	04	CR8EIX	4218
400	4	XJ		-	0,70		D8EA	2120	11	DR8EIX	6681
400	2	XJR	R	07-	0,70		CR9E	6263	06	CR9EIX	3521
400	2	XVS		07-08	0,90		DPR7EA-9	5129	13	DPR7EIX-9	7803
400		YFM	FW Kodiak	92-99	0,60		DR8EA	7162	11	DR8EIX	6681
400	1	YP	W Majesty	07-	0,70		CR7E	4578	12	CR7EIX	7385
400		YZ	C, E	-	0,60		-	-	-	BR8EIX	5044
400	4	YZ	F	98-99	0,70		CR8E	1275	04	CR8EIX	4218
426	1	WR	F	00-	0,70		CR8E	1275	04	CR8EIX	4218
426	1	YZ	F	99-	0,70		CR8E	1275	04	CR8EIX	4218
450	1	WR	F	03-	0,70		CR8E	1275	04	CR8EIX	4218
450		WR	FX	08-	0,70		CR8E	1275	04	CR8EIX	4218
450		YZ	F/FW/FX	07-	0,80		CR8E	1275	04	CR8EIX	4218
450	1	YZ	F	10-	0,70		CR8E	1275	04	CR8EIX	4218
450	1	YZF	F	04-	0,70		CR8E	1275	04	CR8EIX	4218
450		YZF	F	09-	0,70		CR8E	1275	04	CR8EIX	4218
465		IT	H/J	-	0,80		B8ES	2411	05	BR8EIX	5044
465		YZ	H	-	0,80		B8ES	2411	05	BR8EIX	5044
490		YZ	K/L/N/S/T/U/W	-	0,60		B9EG	3530	-	-	-
500		HL		-	0,60		BP7ES	2412	-	BPR7EIX	4055
500		SR	E, H	-96	0,80		BP7ES	2412	-	BPR7EIX	4055
500		SR		97-	0,80		BPR7ES	2023	-	BPR7EIX	4055
500	2	XP	T-Max	00-	0,80		CR7E	4578	12	CR7EIX	7385
500		XS	X/E	-	0,70		D9EA	2420	-	DR9EIX	4772
500		XT		-	0,80		BPR7ES	2023	-	BPR7EIX	4055
500		XT	T	-	0,90		DPR8EA-9	4929	08	DPR8EIX-9	2202
500	2	YP	T-Max ABS	-	0,60		CR7E	4578	12	CR7EIX	7385
535		XV	DX Virago	88-01	0,80		BPR7ES	2023	-	BPR7EIX	4055
535		XV	S/SP	-	0,80		BPR7ES	2023	-	BPR7EIX	4055
550		XJ		-	0,70		D8EA	2120	11	DR8EIX	6681
550		XT		-	0,60		DR7ES	3123	-	DR7EIX	5686
550		XT	J/K	-	0,70		D8EA	2120	11	DR8EIX	6681
550	2	XZ		-	0,70		DR8ES-L	2923	-	DR8EIX	6681
600		FZ		-	0,70		DR8ES-L	2923	-	DR8EIX	6681
600	4	FZ6	Fazer	03-06	0,80		CR9EK	4548	-	CR9EIX	3521
600	4	FZ6	Fazer S2	07-	0,80		CR9EK	4548	-	CR9EIX	3521
600		FZ6R	Fazer	10-	0,70		CR9E	6263	06	CR9EIX	3521
600		FZR	R	-	0,80		CR9E	6263	06	CR9EIX	3521
600	4	FZS	Fazer	98-04	0,70		CR8E	1275	04	CR8EIX	4218
600		SRX		-	0,90		DPR8EA-9	4929	08	DPR8EIX-9	2202

CYL.	Nb Cyl.	TYPE	MODÈLE		INFO			N° STOCK	N° BLISTER		N° STOCK IX
600		TTR	E / R	96-99		0,90	DPR8EA-9	4929	08	DPR8EIX-9	2202
600	4	XJ		-		0,70	DR8ES-L	2923	-	DR8EIX	6681
600	4	XJ	N & S Diversion	91-02		0,70	CR8E	1275	04	CR8EIX	4218
600	4	XJ	6N / 6NA / 6S / 6SA / 6SY	09-		0,80	CR9E	6263	06	CR9EIX	3521
600	1	XT	Tous modèles	86-		0,90	DPR8EA-9	4929	08	DPR8EIX-9	2202
600	2	XV	V Star Classic	08-		0,90	DPR7EA-9	5129	13	DPR7EIX-9	7803
600	4	YZF	R, R Thundercat	96-		0,80	CR9E	6263	06	CR9EIX	3521
600	4	YZF	R6	99-		0,70	CR10EK	2360	-	CR10EIX	6482
600	4	YZF	RW	07-		0,80	CR9E	6263	06	CR9EIX	3521
600	4	YZF	R6SW, R6S	07-		0,70	CR10EK	2360	-	CR10EIX	6482
650	2	XS	E, SE, Special	-		0,80	BP7ES	2412	-	BPR7EIX	4055
650	2	XVS	Drag Star (4VR / 4XR)	97-		0,90	DPR7EA-9	5129	13	DPR7EIX-9	7803
650	2	XVS	V-Star Midnight	06-		0,90	DPR7EA-9	5129	13	DPR7EIX-9	7803
660	1	MT-03		06-		0,70	CR7E	4578	12	CR7EIX	7385
660		SZR		-		0,90	DPR8EA-9	4929	08	DPR8EIX-9	2202
660	1	XTZ	Tenere	-		0,90	DPR8EA-9	4929	08	DPR8EIX-9	2202
660		YFM	R Raptor	01-		0,90	DPR8EA-9	4929	08	DPR8EIX-9	2202
660	1	XTR		04-		0,70	CR7E	4578	12	CR7EIX	7385
660	1	XT	R / X	04-		0,70	CR7E	4578	12	CR7EIX	7385
700	2	MT-07		14-		0,90	LMAR8A-9	4313	-	-	-
700	2	MT-07	Tracer	17-		0,90	LMAR8A-9	4313	-	-	-
750		FZ	Génésis	-		0,70	DR8ES-L	2923	-	DR8EIX	6681
750		FZR	R	89-		0,70	DR9EA	3437	-	DR9EIX	4772
750	4	FZX		-		0,80	DR8ES-L	2923	-	DR8EIX	6681
750		XJ	RH	-		0,70	BP7ES	2412	-	BPR7EIX	4055
750	3	XS	C, D, E, SE	-		0,70	BP7ES	2412	-	BPR7EIX	4055
750		XTZ	Super Tenere	-		0,90	DPR8EA-9	4929	08	DPR8EIX-9	2202
750		XV	F / FC / SE	-		0,70	BPR7ES	2023	-	BPR7EIX	4055
750		YZF	R RF/RFC, SP/SPF	93-		0,70	CR9E	6263	06	CR9EIX	3521
750	4	YZF	R7 (OW 02)	99-		0,70	R0373A-10	4940	-	-	-
800	4	FZ8	FZ8-S / FZ8-SA / FZ8-N	10-		0,70	CR9E	6263	06	CR9EIX	3521
800	4	FZ8	Redline	12-		0,70	CR9E	6263	06	CR9EIX	3521
850		TDM		91-96		0,90	DPR9EA-9	5329	-	DPR9EIX-9	5545
850	2	TDM		97-01		0,90	DPR8EA-9	4929	08	DPR8EIX-9	2202
850		TRX		96-		0,90	DPR9EA-9	5329	-	DPR9EIX-9	5545
850	3	MT-09		14-		0,90	CPR9EA-9	2308	-	-	-
850	3	MT-09	Tracer	17-		0,90	CPR9EA-9	2308	-	-	-
900	2	TDM		02-		0,90	DPR8EA-9	4929	08	DPR8EIX-9	2202
900	4	XJ	S Diversion & GT Diversion	95-		0,90	DPR8EA-9	4929	08	DPR8EIX-9	2202
900	3	XSR		16-		0,90	CPR9EA-9	2308	-	-	-
900	3	XSR	Abarth	17-		0,90	CPR9EA-9	2308	-	-	-
950	2		V Star, V Star Tourer	12-		0,90	CPR7EA-9	3901	-	CPR7EAIX-9	9198
950	2	SCR		17-		0,90	CPR7EA-9	3901	-	CPR7EAIX-9	9198
950		XVS	A Midnight Star	09-		0,90	CPR7EA-9	3901	-	CPR7EAIX-9	9198
1000	2		MT-01	07-		0,90	DPR7EA-9	5129	13	DPR7EIX-9	7803
1000			TR1	-		0,70	BPR7ES	2023	-	BPR7EIX	4055
1000	4	FZ-1	Fazer	06-07		0,80	CR9EK	4548	-	CR9EIX	3521
1000	4	FZ-1	Fazer / S / SA / SX / SY	08-		0,80	CR9EK	4548	-	CR9EIX	3521
1000	4	FZR	FC	94-		0,70	DR8EA	7162	11	DR8EIX	6681
1000	4	FZR	U	94-		0,90	DP8EA-9	5829	08	DPR8EIX-9	2202
1000	4	FZS	Fazer	00-		0,80	CR9E	6263	06	CR9EIX	3521
1000	4	GTS	A, ABS, Free Way	-		0,90	DPR8EA-9	4929	08	DPR8EIX-9	2202
1000	2	XV	SE	-		0,70	BPR7ES	2023	-	BPR7EIX	4055
1000	4	YZF	R Thunderace	95-		0,90	DR8EA	7162	11	DR8EIX	6681
1000	4	YZF	R1	98-01		0,70	CR9E	6263	06	CR9EIX	3521
1000	4	YZF	R1	02-03		0,90	CR9EIA-9	6289	-	-	-
1000	4	YZF	R1	04-08		0,80	CR9EK	4548	-	CR9EIX	3521
1000	4	YZF	R1	09-		0,70	LMAR9E-J	6884	-	-	-
1000	4	YZF	R1	12-		0,70	LMAR9E-J	6884	-	-	-
1100	4	BT	Bulldog	02-		0,70	BPR7ES	2023	-	BPR7EIX	4055
1100	4	XS	E, H, LH, RH, S	-		0,80	BP6ES	7811	-	BPR6EIX	6637
1100		XV	Virago	-98		0,70	BPR7ES	2023	-	BPR7EIX	4055
1100	2	XVS	Drag Star / A Classic	99-		0,70	BR7ES	5122	-	BR7EIX	6664
1100		XVS	V-Star Midnight	06-		0,70	BPR7ES	2023	-	BPR7EIX	4055
1100	2	XVS	V Star Classic, Custom	08-		0,70	BPR7ES	2023	-	BPR7EIX	4055
1100	2	XVS	XB / XBC V Star Midnight Custom	08-		0,70	BPR7ES	2023	-	BPR7EIX	4055
1200	4		V-Max	88-02		0,90	DPR8EA-9	4929	08	DPR8EIX-9	2202
1200		FJ		89-96		0,90	DPR8EA-9	4929	08	DPR8EIX-9	2202
1200	4	XJR	SP	95-98		0,90	DPR8EA-9	4929	08	DPR8EIX-9	2202
1200	2	XT	Z Super Ténére	10-		0,90	CPR8EB-9	6607	-	-	-
1300	4	FJR		01-		0,80	CR8E	1275	04	CR8EIX	4218
1300		FJR	/A	01-		0,70	CR8E	1275	04	CR8EIX	4218
1300		FJR	/A	13-		0,90	CPR8EA-9	2306	-	-	-
1300		FJR	A/AS	06-		0,70	CR8E	1275	04	CR8EIX	4218
1300	4	XJR	& SP	99-		0,90	DPR8EA-9	4929	08	DPR8EIX-9	2202





CYL.	Nb Cyl.	TYPE	MODÈLE		INFO		N° STOCK	N° BLISTER		N° STOCK IX
1300	4	XV	TD	-		0,90	DPR8EA-9 4929	08	DPR8EIX-9	2202
1300	2	XVS	V Star / Tourer	08-		0,90	LMAR7A-9 4908	-	-	-
1300	4	XVZ	A Royal Star, A Midnighn Star	98-01		0,90	DPR7EA-9 5129	13	DPR7EIX-9	7803
1300	4	XVZ	TF Venture	08-		0,90	DPR8EA-9 4929	08	DPR8EIX-9	2202
1304	2		Stryker	12-		0,90	LMAR7A-9 4908	-	-	-
1600	2	XV	A Wild Star	99-02		0,90	DPR7EA-9 5129	13	DPR7EIX-9	7803
1670	2	MT-01		05-		0,90	DPR7EA-9 5129	13	DPR7EIX-9	7803
1670	4		Road Star S, Road Star Silverado S	12-		0,90	DPR7EA-9 5129	13	DPR7EIX-9	7803
1679	4		V Max	12-		0,90	CR9EIA-9 6289	-	-	-
1700	2		V-Max	09-		0,90	CR9EIA-9 6289	-	-	-
1700	2	XV	Road Star Warrior	08-		0,90	DPR7EA-9 5129	13	DPR7EIX-9	7803
1854	4		Roadliner S, Royal Star Venture S	12-		0,90	DPR8EA-9 4929	08	DPR8EIX-9	2202
1854	4		Stratoliner Deluxe, Stratoliner S	12-		0,90	DPR8EA-9 4929	08	DPR8EIX-9	2202
1854	4	XV	1900, S	12-		0,90	DPR8EA-9 4929	08	DPR8EIX-9	2202
1900	4		Star Stratoliner Deluxe	10-		0,90	DPR8EA-9 4929	08	DPR8EIX-9	2202
1900	2	XV	Midnight Star	06-		0,90	DPR8EA-9 4929	08	DPR8EIX-9	2202



YAMAHA - Quad

50	1	YFM	RV / RX	06-		0,70	CR7HSA 4549	07	CR7HIX	7544
50	1	YFM	S	04-		0,70	CR7HS 7223	-	-	-
60	1	YF	(1HN)	87-		0,70	BPR6HS 7022	-	BPR6HIX	4085
60	1	YF	S	86-		0,70	BP6HS 4511	-	BPR6HIX	4085
80	1	YFM		-		0,70	CR7HS 7223	-	-	-
80	1	YFM	E / F	93-		0,70	C7HSA 4629	07	CR7HIX	7544
80	1	YFM	RV	06-		0,70	CR7HSA 4549	07	CR7HIX	7544
80	1	YFM	S / T	85-		0,70	CR7HSA 4549	07	CR7HIX	7544
80	1	YFM	W (4x2)	02-		0,70	CR7HSA 4549	07	CR7HIX	7544
80	1	YFM	Grizzly	08-		0,70	CR7HSA 4549	07	CR7HIX	7544
90	1	YFM	Raptor	09-		0,80	CR7HSA 4549	07	CR7HIX	7544
100	1	YFM	T Champ, U Champ	87-		0,70	CR7HSA 4549	07	CR7HIX	7544
125	1		Grizzly	12-		0,80	CR7HSA 4549	07	CR7HIX	7544
125	1	YFA	1 Breeze	89-		0,70	CR7HS 7223	-	-	-
125	1	YFA	1 F	94-		0,70	C7HSA 4629	07	CR7HIX	7544
125	1	YFA	Breeze (4x2)	96-		0,70	CR7HSA 4549	07	CR7HIX	7544
125	1	YFM	A	07-		0,80	CR7HSA 4549	07	CR7HIX	7544
125	1	YFM	G	09-		0,80	CR7HSA 4549	07	CR7HIX	7544
125	1	YFM	GHX, GX	08-		0,70	CR7HSA 4549	07	CR7HIX	7544
125	1	YT	/ CH	-		0,80	BP6ES 7811	-	BPR6EIX	6637
125	1	YT	N	85-		0,70	BP5ES 6511	-	BPR5EIX	6597
125	1	YZ	Grizzly	08-		0,70	CR7HSA 4549	07	CR7HIX	7544
175		YT		-		0,80	BP7ES 2412	-	BPR7EIX	4055
200	1	YFM		92-		0,60	D7EA 7912	-	DR7EIX	5686
200	1	YFM	(2HT), (59V)	-		0,70	DR7ES 3123	-	DR7EIX	5686
200	1	YFM	(52H)	85-		0,70	DR7ES 3123	-	DR7EIX	5686
200		YFM	DXS / S / DXT	86-		0,60	D7EA 7912	-	DR7EIX	5686
200	1	YFS	Blaster	90-04		0,70	BR8ES 5422	05	BR8EIX	5044
200	1	YFS	E / F	93-		0,80	B8ES 2411	05	BR8EIX	5044
225		TT		-		0,70	DR8ES-L 2923	-	DR8EIX	6681
225	1	YFM	59V/2HT	92-		0,70	DR7ES 3123	-	DR7EIX	5686
250	1		Raptor	12-		0,70	DR7EA 7839	-	DR7EIX	5686
250		YFB	/ E / F / FWF	93-		0,70	D7EA 7912	-	DR7EIX	5686
250		YFB	/ FW	94-		0,70	DR7EA 7839	-	DR7EIX	5686
250		YFB	Timberwolf (4x2)	-99		0,70	DR7EA 7839	-	DR7EIX	5686
250	1	YFM	(3GH), (4x2)	90-		0,70	DR7ES 3123	-	DR7EIX	5686
250		YFM	Big Bear Raptor	08-		0,70	DR7EA 7839	-	DR7EIX	5686
250	1	YFM	Bruin	05-		0,60	DR7EA 7839	-	DR7EIX	5686
250	1	YFM	R	08-		0,70	DR7EA 7839	-	DR7EIX	5686
250	1	YFM	Timberwolf	-		0,70	DR7EA 7839	-	DR7EIX	5686
250		YFM	X Bear Tracker (4x2)	99-		0,70	DR7EA 7839	-	DR7EIX	5686
250		YTZ	N / S	85-		0,70	B8ES 2411	05	BR8EIX	5044
350	1		Raptor	12-		0,70	DR8EA 7162	11	DR8EIX	6681
350		YFM	(4x2)	89-		0,70	DR8ES-L 2923	-	DR8EIX	6681
350	1	YFM	2HR/2HN	92-		0,60	DR8ES-L 2923	-	DR8EIX	6681
350	1	YFM	4x4 (2HR), 4x4 (3HN)	-		0,70	DR8ES-L 2923	-	DR8EIX	6681
350		YFM	ERT / FWT / XT	87-		0,70	D8EA 2120	11	DR8EIX	6681
350		YFM	ERF / FWF / XF	94-		0,70	D8EA 2120	11	DR8EIX	6681
350	1	YFM	FW	94-		0,70	DR8EA 7162	11	DR8EIX	6681
350		YFM	FWB Big Bear (4x4)	-01		0,70	DR8EA 7162	11	DR8EIX	6681
350		YFM	FWX Wolverine (4x4)	-98		0,70	DR8EA 7162	11	DR8EIX	6681
350		YFM	Grizzly, Raptor, Wolverine	08-		0,70	DR8EA 7162	11	DR8EIX	6681
350	1	YFM	Grizzly 4x2 / 4x4	09-		0,60	DR8EA 7162	11	DR8EIX	6681
350		YFM	U Big Bear (4x2)	-00		0,70	DR8EA 7162	11	DR8EIX	6681
350	1	YFM	X Warrior (4x2)	95-03		0,70	DR8EA 7162	11	DR8EIX	6681
350	2	YFZ		94-		0,80	BR8ES 5422	05	BR8EIX	5044
350	2	YFZ	Banshee	86-		0,80	BR8ES 5422	05	BR8EIX	5044

YAMAHA - Quad



CYL.	Nb Cyl.	TYPE	MODÈLE		INFO			N° STOCK	N° BLISTER		N° STOCK IX
350	2	YFZ	E / F	93-		0,80	B8ES	2411	05	BR8EIX	5044
350		YFZ	T	87-		0,70	B8ES	2411	05	BR8EIX	5044
400	1		Big Bear 4x4, Big Bear 4x4 Hunter	12-		0,70	DR8EA	7162	11	DR8EIX	6681
400	1	YFM		93-		0,70	DR8ES-L	2923	-	DR8EIX	6681
400	1	YFM	Big Bear 4x4	08-		0,60	DR8EA	7162	11	DR8EIX	6681
400	1	YFM	AN Kodiak (4x2)	03-04		0,70	DR8EA	7162	11	DR8EIX	6681
400	1	YFM	FW	94-		0,70	DR8EA	7162	11	DR8EIX	6681
400		YFM	FW Big Bear Pro (4x4)	00-		0,60	DR8EA	7162	11	DR8EIX	6681
400		YFM	FWA Kodiak (4x4)	-00		0,60	DR8EA	7162	11	DR8EIX	6681
400	1	YFM	FWA Kodiak	00-		0,70	DR8EA	7162	11	DR8EIX	6681
400		YFM	FWAN Kodiak (4x2 & 4X4)	03-04		0,70	DR8EA	7162	11	DR8EIX	6681
400	1	YFM	FWF	94-		0,70	D8EA	2120	11	DR8EIX	6681
450		YFM		08-		0,70	DR8EA	7162	11	DR8EIX	6681
450	1	YFM	Grizzly 4x4	09-		0,60	DR7EA	7839	-	DR7EIX	5686
450	1	YFM	Wolverine 4x4	08-		0,60	DR8EA	7162	11	DR8EIX	6681
450	1	YFZ	R, X	08-		0,70	CR8E	1275	04	CR8EIX	4218
450	1	YFZ	V / S	06-		0,80	CR8E	1275	04	CR8EIX	4218
500		YFM		08-		0,70	CR7HSA	4549	07	CR7HIX	7544
550		YFM	G	09-		0,90	LMAR6A-9	5946	-	-	-
550		YFM	Grizzly	09-		0,90	LMAR7A-9	4908	-	-	-
600		YFM	FWA Grizzly (4x4)	-01		0,90	DP8EA-9	5829	08	DPR8EIX-9	2202
660		YFM	Grizzly	08-		0,90	DPR8EA-9	4929	08	DPR8EIX-9	2202
660		YFM	FWA Grizzly (4x2 & 4x4)	01-		0,90	DPR8EA-9	4929	08	DPR8EIX-9	2202
660	1	YFM	R (4x2)	00-04		0,90	DPR8EA-9	4929	08	DPR8EIX-9	2202
700	1		Raptor	05-		0,60	CR7E	4578	12	CR7EIX	7385
700	1		Grizzly EPS 4wd, Grizzly EPS 4wd Hunter	12-		0,90	LMAR6A-9	5946	-	-	-
700	1		Raptor R, Raptor R Special edition	12-		0,60	CR8E	1275	04	CR8EIX	4218
700	1	YFM		05-		0,70	CR8E	1275	04	CR8EIX	4218
700		YFM	FI EPS	10-		0,90	LMAR6A-9	5946	-	-	-
700	1	YFM	Raptor	08-		0,70	CR8E	1275	04	CR8EIX	4218
700	1	YFM	Grizzly	06-		0,90	CPR7EA-9	3901	-	CPR7EAIX-9	9198
700	1	YFM	Grizzly	09-		0,90	LMAR7A-9	4908	-	-	-
700	1	YFM	R	06-		0,70	CR8E	1275	04	CR8EIX	4218
700	1	YFM	Rhino	08-09		0,90	CPR7EA-9	3901	-	CPR7EAIX-9	9198
700	1	YFM	RV	06-		0,80	CR8E	1275	04	CR8EIX	4218
800		YFM	Grizzly	08-		0,70	CR7HSA	4549	07	CR7HIX	7544

YAMAHA - SSV

450		YXR	Rhino	06-		0,70	DR8EA	7162	11	DR8EIX	6681
660		YXR	AS, AT Rhino	04-		0,90	DPR8EA-9	4929	08	DPR8EIX-9	2202
700	1	YFM	Rhino FI Hunter	08-		0,90	CPR7EA-9	3901	-	CPR7EAIX-9	9198
700	1	YXR	Rhino FI	08-		0,90	CPR7EA-9	3901	-	CPR7EAIX-9	9198
700		YXP	AS/AT/AVL Pro Hauler 2WD - Bougie 'chaude'	04-07		0,80	BPR2ES	2264	-	-	-
700		YXP	AS/AT/AVL Pro Hauler 2WD - Bougie 'froide'	04-07		0,80	BPR4ES	7222	-	-	-
900		DIESEL	RTV (Moteur Diesel)	04-		11V	YE01	2649	-	-	-
1000		YXP	AS/AT Pro hauler - Bougie 'chaude'	04-06		0,80	BPR2ES	2264	-	-	-
1000		YXP	AS/AT Pro hauler - Bougie 'froide'	04-06		0,80	BPR4ES	7222	-	-	-

YAMAHA - Motoneige

80	1		SE80, SV80 Series	-		0,70	BR8HS	4322	01	BR8HIX	7001
125			SV125 Series	-		0,70	BR8HS	4322	01	BR8HIX	7001
250			BR250 Series	-		0,70	BR8HS	4322	01	BR8HIX	7001
250			ET250 Series	-		0,70	B8HS	5510	01	BR8HIX	7001
250			ET250A/B	-		0,60	-	-	-	BR8HIX	7001
300			CF300	-		0,70	BR8HS	4322	01	BR8HIX	7001
300			EC300, ET300 Series	-		0,80	BR9ES	5722	02	BR9EIX	3981
300			ET300C	-		0,60	-	-	-	BR9EIX	3981
340			CS340 / E / EC, EC / ET 340 Series	-		0,80	BR9ES	5722	02	BR9EIX	3981
340			ET340 / B / C / EC	-		0,60	-	-	-	BR9EIX	3981
340			EX570 Series	-		0,80	BR9ES	5722	02	BR9EIX	3981
340			S340	-		0,80	BR8ES	5422	05	BR8EIX	5044
400			ET400 Series	-		0,80	BR8ES	5422	05	BR8EIX	5044
440			SS440 Series	-		0,80	BR9ES	5722	02	BR9EIX	3981
480			PZ480 Series, VT480 Series	-		0,80	BR9ES	5722	02	BR9EIX	3981
499	2		Venture Lite / Multi Purpose	10-		0,70	CR9EKB	2305	-	CR9EIX	3521
499	2	GT	Phazer	12-		0,80	CR9EKB	2305	-	CR9EIX	3521
499	2	MTX	Phazer	10-		0,70	CR9EKB	2305	-	CR9EIX	3521
499	2	RTX	Phazer	10-		0,70	CR9EKB	2305	-	CR9EIX	3521
500			PZ500 / C / DX / ML / MLD / ST, SX500 / D	-		0,80	BR9ES	5722	02	BR9EIX	3981
500			VT500 Series, VX500 Series	-		0,80	BR9ES	5722	02	BR9EIX	3981
540			VK540 Series, XL540 Series	-		0,80	BR9ES	5722	02	BR9EIX	3981
540		VK	III	05-		0,80	BR9ES	5722	02	BR9EIX	3981
600			MM600/D	-		0,80	BR9ES	5722	02	BR9EIX	3981

CYL.	Nb Cyl.	TYPE	MODÈLE		INFO		N° STOCK	N° BLISTER		N° STOCK IX
600			SRX600 / C / S / SC	99-		0,80	BR9ECS	3570	-	-
600			SRX600 Series	-98		0,80	BR10ECS	5880	-	-
600			SX600 / D	-		0,80	BR9ES	5722	02	BR9EIX 3981
600			VT600 / C / D	99-		0,80	BR9ES	5722	02	BR9EIX 3981
600			VT600	-00		0,80	BR9ECS	3570	-	-
600			VX600 Series	-		0,80	BR9ES	5722	02	BR9EIX 3981
700			MM700/D	-		0,80	BR9ES	5722	02	BR9EIX 3981
700			SRX700 / C / S / SC	99-		0,80	BR9ECS	3570	-	-
700			SRX700 Series	-98		0,80	BR10ECS	5880	-	-
700			SX700 / D / SD, VT700 Series, VX700 Series	-		0,80	BR9ES	5722	02	BR9EIX 3981
750			VX750 Series	-		0,80	BR9ES	5722	02	BR9EIX 3981
800			VX800 Series	-		0,80	BR9ES	5722	02	BR9EIX 3981
973		RS	Rage / Venture TF / Vector GT	05-		0,70	CR9E	6263	06	CR9EIX 3521
973		RS	Nytro ER Nytro / Vertor	06-		0,70	CR8E	1275	04	CR8EIX 4218
973	3	RS	Viking Professional	10-		0,70	CR9E	6263	06	CR9EIX 3521
973		RSG	RS Rage	06-		0,70	CR8E	1275	04	CR8EIX 4218
998	4		Apex / SE / XTX	12-		0,70	CR9EB	6955	06	CR9EIX 3521
998		RX	Apex	06-		0,70	CR9EB	6955	06	CR9EIX 3521
998		RXW-10	Attak	06-		0,70	CR9EB	6955	06	CR9EIX 3521
998		RX-1	ER	05-		0,70	CR9E	6263	06	CR9EIX 3521
998		RX	Warrior	05-		0,70	CR9E	6263	06	CR9EIX 3521
998	4	RX	Warrior GT	10-		0,70	CR9E	6263	06	CR9EIX 3521
1049	2		Venture Lite	12-		0,80	CR9EKB	2305	-	CR9EIX 3521
1049	3	FX	FX Nytro M-TX SE 162	10-		0,70	CR9E	6263	06	CR9EIX 3521
1049	3	FX	FX Nytro R-TX SE / X-TX	10-		0,70	CR9E	6263	06	CR9EIX 3521
1049	3	RS	Venture TF 120 FI / GT	09-		0,70	CR9E	6263	06	CR9EIX 3521



YIYING

50	1	YY		-		0,70	CR7HSA	4549	07	CR7HIX 7544
125	1	YY		-		0,70	CR7HSA	4549	07	CR7HIX 7544
250	1			-		0,70	CR7HSA	4549	07	CR7HIX 7544



ZHONGNENG

50	1		Sixies	06-		0,70	CR7HSA	4549	07	CR7HIX 7544
----	---	--	--------	-----	--	------	--------	------	----	-------------



ZHEN

50	1		Viper	06-		0,70	CR7HSA	4549	07	CR7HIX 7544
----	---	--	-------	-----	--	------	--------	------	----	-------------



ZONGSHEN

50	1		Explorer Flash 50	-		0,60	CR7HSA	4549	07	CR7HIX 7544
50	1		Qingqi B2 2 tps / QM50QT-B2	08-		0,50	BP7HS	5111	14	BPR7HIX 5944
50	1		Ride Flash	-		0,60	CR7HSA	4549	07	CR7HIX 7544
50	1		Vento Phantom / Triton / Zip 2 Temps	08-		0,50	BP7HS	5111	14	BPR7HIX 5944
125			Arktix, Predator ZS125-GY10	-		0,70	DR8EA	7162	11	DR8EIX 6681
125	1		Explorer	-		0,60	CR7HSA	4549	07	CR7HIX 7544
125	1		Explorer MRS, MRX	-		0,90	DP8EA-9	5829	08	DPR8EIX-9 2202
125	1		Explorer Phantom 125	-		0,60	CR7HSA	4549	07	CR7HIX 7544
125	1		Qingqi 10D GY6 4 Temps	08-		0,60	CR7HSA	4549	07	CR7HIX 7544
125	1		Ride MRS, MRX	-		0,90	DP8EA-9	5829	08	DPR8EIX-9 2202
125	1		Ride Phantom	-		0,60	CR7HSA	4549	07	CR7HIX 7544
150	1		Qingqi 10D GY6 4 Temps	08-		0,60	CR7HSA	4549	07	CR7HIX 7544
250			Storm ZS250GS	-		0,60	D8EA	2120	11	DR8EIX 6681



ZONGSHEN - Quad

125	1		ZS 125 ST	04-		0,60	BKR5E	7938	-	BKR5EIX 6341
200	1		Shineray	-		0,70	D8EA	2120	11	DR8EIX 6681



CAPUCHONS ANTIPARASITES

CAPUCHONS ANTIPARASITES







SIGNIFICATION DES RÉFÉRENCES

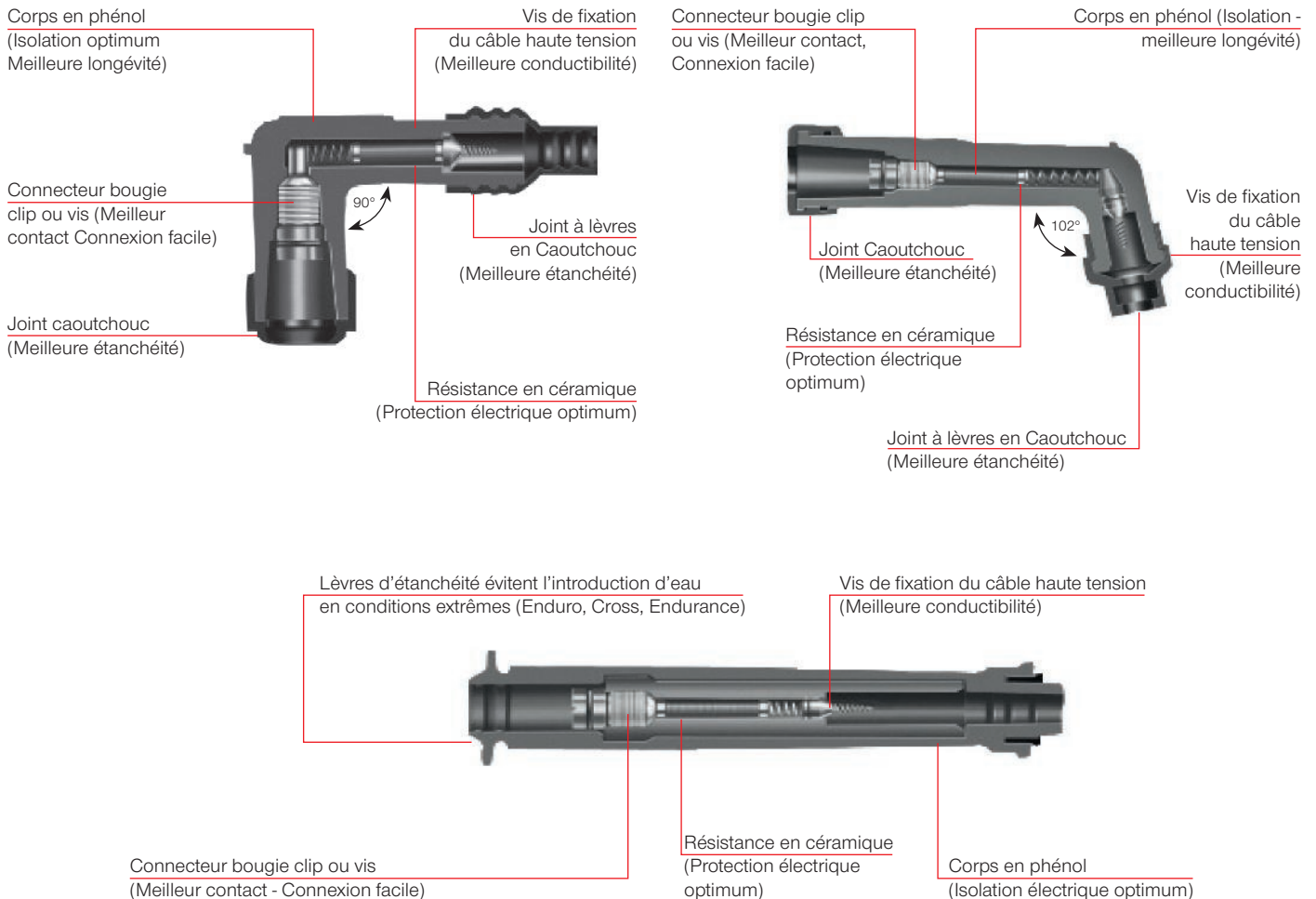

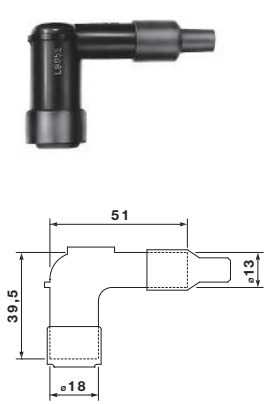
L	B	10	E	H F
Apparence	Filetage bougie	Résistance	Embout bougie	Apparence
L Coude 90°	B Ø 14 mm	Vide 0 kΩ	E Avec olive	A Design spécial
S Droit	C Ø 10 mm	01 1 kΩ	F Sans olive	F Pour câble HT Ø 5 mm
X Coude à 102°	D Ø 10 & 12 mm	05 5 kΩ		G Avec joint pour volute moteur
V Coude à 120° (long)	Z Ø 10, 12, 14 mm	10 10 kΩ		H Type compact
Y Coude à 120° (court)				K Joint silicone étanche
T Type "T"				L Résistance bobinée
				M Gaine caoutchouc
				P Joint spécial étanche
				S Blindé
				Y Avec ergot de préhension
				Z Forme spéciale

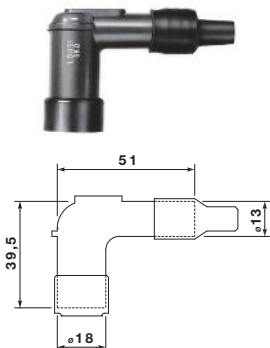

TECHNOLOGIES



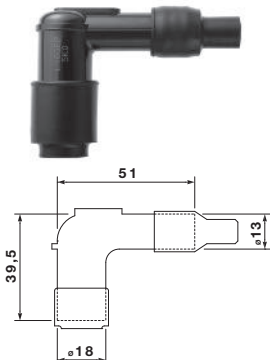



Résine Phénolique		TYPE	NGK	N° STOCK	COUL.	R (kΩ)	Ø Bougie (mm)	CONNEXION
	LB	LB-E		8302	Noir	/	14	
		LB01E		8011	Noir	1 kΩ		
		LB05E		8031	Noir	5 kΩ		
		LB05E-R		8898	Rouge	5 kΩ		
		LB10E		8349	Noir	10 kΩ		
		LB-F		8309	Noir	/	14	
		LB01F		8330	Noir	1 kΩ		
		LB01FF		8331	Noir	1 kΩ		
		LB05F		8051	Noir	5 kΩ		
		LB05F-R		8854	Rouge	5 kΩ		
		LB05FF		30326	Noir	5 kΩ		
		LB10F		8358	Noir	10 kΩ		
		LB10FF		8359	Noir	10 kΩ		

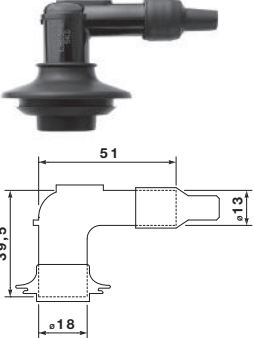

Résine Phénolique		TYPE	NGK	N° STOCK	COUL.	R (kΩ)	Ø Bougie (mm)	CONNEXION
	LD	LD05E		6902	Noir	5 kΩ	10-12	
		LD-F		8311	Noir	/	10-12	
		LD01F		8362	Noir	1 kΩ		
		LD05F-R		8231	Rouge	5 kΩ		
		LD10F		8997	Noir	10 kΩ		

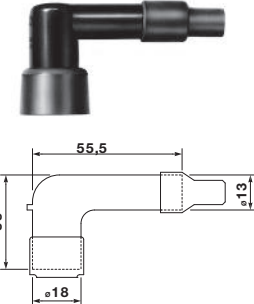

Résine Phénolique		TYPE	NGK	N° STOCK	COUL.	R (kΩ)	Ø Bougie (mm)	CONNEXION
	LB	LBEPK		8304	Noir	/	14	
		LB01EP		8328	Noir	1 kΩ		
		LB05EP		8020	Noir	5 kΩ		
		LB05EPK		8342	Noir	5 kΩ	14	
		LB01FP		8088	Noir	1 kΩ		
	LB05FP		8030	Noir	5 kΩ			
	LD	LD05FP		8070	Noir	5 kΩ	10-12	

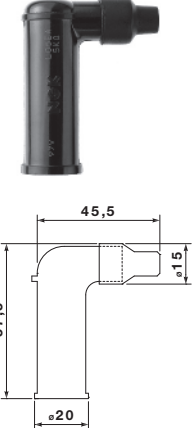

Résine Phénolique	TYPE	NGK	N° STOCK	COUL.	R (kΩ)	Ø Bougie (mm)	CONNEXION
	LZ	LZ05F	8368	Noir	5 kΩ	10-12-14	

Résine Phénolique	TYPE	NGK	N° STOCK	COUL.	R (kΩ)	Ø Bougie (mm)	CONNEXION
	LB	LB05FG	8346	Noir	5 kΩ	14	



Résine Phénolique	TYPE	NGK	N° STOCK	COUL.	R (kΩ)	Ø Bougie (mm)	CONNEXION
	LB	LB05EZ	8744	Noir	5 kΩ	14	

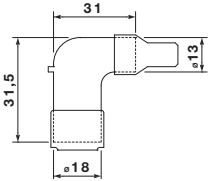

Résine Phénolique	TYPE	NGK	N° STOCK	COUL.	R (kΩ)	Ø Bougie (mm)	CONNEXION
	L	L05EA	6667	Noir	5 kΩ	Spéciale	

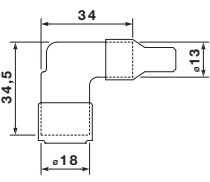

Résine Phénolique	TYPE	NGK	N° STOCK	COUL.	R (kΩ)	Ø Bougie (mm)	CONNEXION
	L	LEH	8301	Noir	/	14	

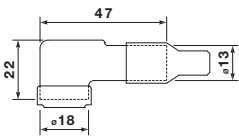

Résine Phénolique	TYPE	NGK	N° STOCK	COUL.	R (kΩ)	Ø Bougie (mm)	CONNEXION
 	LB	LB01EH	8326	Noir	1 kΩ	14	
		LB01EHF	8327	Noir	1 kΩ		
		LB05EH	8334	Noir	5 kΩ		
		LB05EHF	8336	Noir	5 kΩ		
		LB10EH	8351	Noir	10 kΩ		
		LB10EHF	8055	Noir	10 kΩ		
LD	LD-FH	8313	Noir	/	10-12		



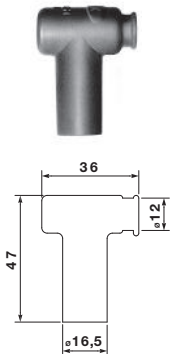

Résine Phénolique	TYPE	NGK	N° STOCK	COUL.	R (kΩ)	Ø Bougie (mm)	CONNEXION
	LB	LB10EHAK	8719	Noir	10 kΩ	14	

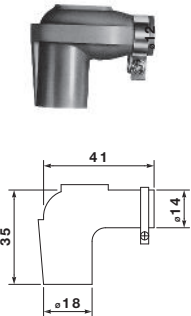

Résine Phénolique	TYPE	NGK	N° STOCK	COUL.	R (kΩ)	Ø Bougie (mm)	CONNEXION
 	LZ	LZEH	8760	Noir	/	10-12-14	
		LZFH	8710	Noir	/	10-12-14	

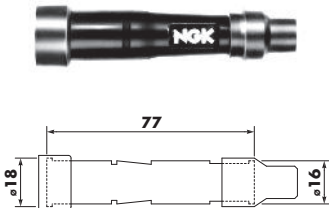

Résine Phénolique	TYPE	NGK	N° STOCK	COUL.	R (kΩ)	Ø Bougie (mm)	CONNEXION
 	LC	LC05EFK	8050	Noir	5 kΩ	10	



Enveloppe Caoutchouc		TYPE	NGK	N° STOCK	COUL.	R (kΩ)	Ø Bougie (mm)	CONNEXION
	LB		LB05EMH	8338	Noir	5 kΩ	14	
			LB05EMH-R	8160	Rouge	5 kΩ		



Caoutchouc (silicone)		TYPE	NGK	N° STOCK	COUL.	R (kΩ)	Ø Bougie (mm)	CONNEXION
	LB		LBER-B	8308	Bleu	/	14	



Résine Phénolique		TYPE	NGK	N° STOCK	COUL.	R (kΩ)	Ø Bougie (mm)	CONNEXION	
	SB		SB01E	8370	Noir	1 kΩ	14		
			SB05E	8374	Noir	5 kΩ			
			SB10E	8803	Noir	10 kΩ			
		SD		SB01F	8372	Noir	1 kΩ	14	
				SB05F	8080	Noir	5 kΩ		
				SB05F-R	8567	Rouge	5 kΩ		
				SB10F	8387	Noir	10 kΩ		
		SD		SD05E	6894	Noir	5 kΩ	10-12	
				SD01F	8388	Noir	1 kΩ	10-12	
				SD05F	8022	Noir	5 kΩ		
			SD05F-R	8238	Rouge	5 kΩ			
			SD10F	8394	Noir	10 kΩ			
	SZ		SZ05F	8396	Noir	5 kΩ	10-12-14		

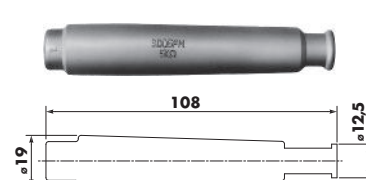

Résine Phénolique		TYPE	NGK	N° STOCK	COUL.	R (kΩ)	Ø Bougie (mm)	CONNEXION
	SB		SB05FP	8386	Noir	5 kΩ	14	
	SD		SD05FP	8325	Noir	5 kΩ	10-12	

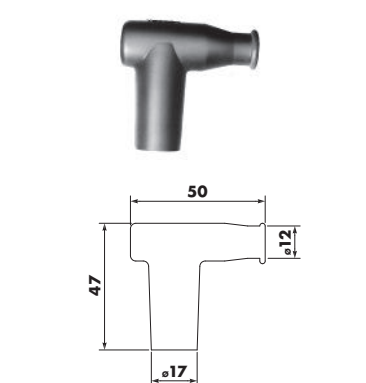

Résine Phénolique	TYPE	NGK	N° STOCK	COUL.	R (kΩ)	Ø Bougie (mm)	CONNEXION
	SD	SD05EG	5818	Noir	5 kΩ	10-12	



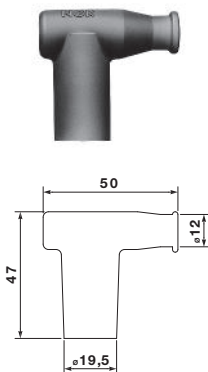

Résine Phénolique	TYPE	NGK	N° STOCK	COUL.	R (kΩ)	Ø Bougie (mm)	CONNEXION
	SD	SD05FGA	8683	Noir	5 kΩ	10-12	

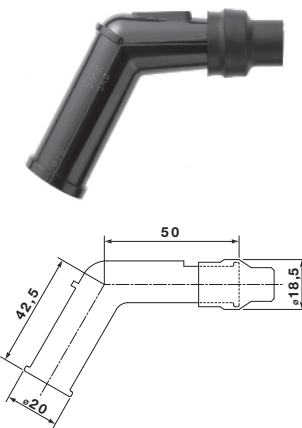

Enveloppe Caoutchouc	TYPE	NGK	N° STOCK	COUL.	R (kΩ)	Ø Bougie (mm)	CONNEXION
	SD	SD05FM	8392	Noir	5 kΩ	10-12	
		SD05FM-R	8673	Rouge	5 kΩ		

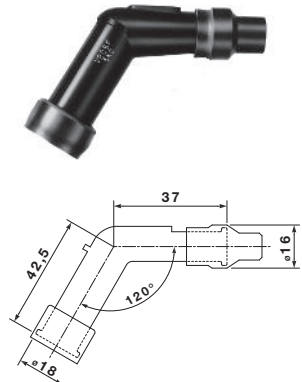

Caoutchouc (silicone)	TYPE	NGK	N° STOCK	COUL.	R (kΩ)	Ø Bougie (mm)	CONNEXION
	TB	TB05EM-R	8955	Rouge	5 kΩ	14	
		TB10EM-Y	8404	Jaune	10 kΩ		

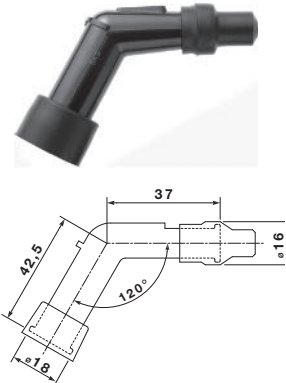

Enveloppe Caoutchouc		TYPE	NGK	N° STOCK	COUL.	R (kΩ)	Ø Bougie (mm)	CONNEXION
	TB	TB05EMA	8636	Noir	5 kΩ	14		

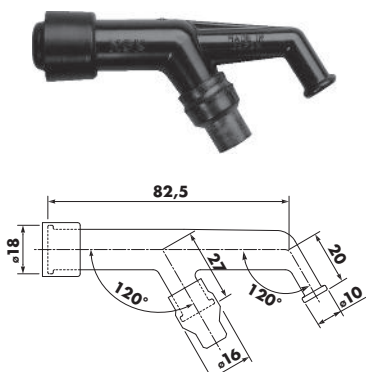

Résine Phénolique		TYPE	NGK	N° STOCK	COUL.	R (kΩ)	Ø Bougie (mm)	CONNEXION
	V	V05E	6665	Noir	5 kΩ	Special		

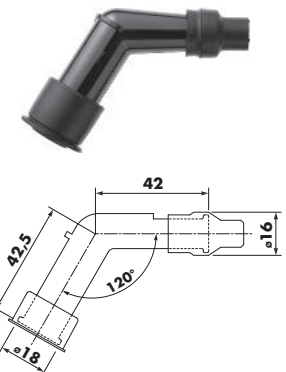

Résine Phénolique		TYPE	NGK	N° STOCK	COUL.	R (kΩ)	Ø Bougie (mm)	CONNEXION
	VB	VB01E	8405	Noir	1 kΩ	14		
		VB05E	8408	Noir	5 kΩ			
		VB-F	8913	Noir	/	14		
		VB01F	8406	Noir	1 kΩ			
		VB05F	8032	Noir	5 kΩ			
		VB05F-R	8759	Rouge	5 kΩ			
	VD	VD01F	8415	Noir	1 kΩ	10-12		
		VD05F	8052	Noir	5 kΩ			
		VD05F-R	8376	Rouge	5 kΩ			
		VD10F	8430	Noir	10 kΩ			



Résine Phénolique	TYPE	NGK	N° STOCK	COUL.	R (kΩ)	Ø Bougie (mm)	CONNEXION
	VB	VB05FP	8413	Noir	5 kΩ	14	

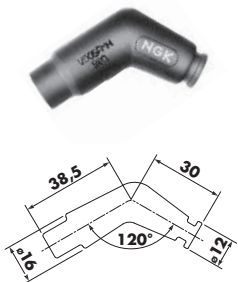

Résine Polyester	TYPE	NGK	N° STOCK	COUL.	R (kΩ)	Ø Bougie (mm)	CONNEXION
	VB	VB05EYK	8411	Noir	5 kΩ	14	

Résine Phénolique	TYPE	NGK	N° STOCK	COUL.	R (kΩ)	Ø Bougie (mm)	CONNEXION
	VD	VD05EG	5817	Noir	5 kΩ	10-12	

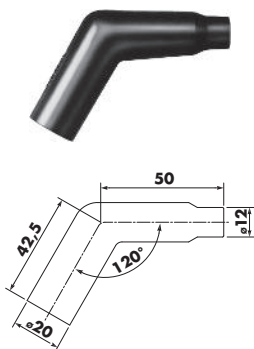
Caoutchouc (silicone)	TYPE	NGK	N° STOCK	COUL.	R (kΩ)	Ø Bougie (mm)	CONNEXION
	VD	VD05EM	8422	Noir	5 kΩ	10-12	

Enveloppe Caoutchouc	TYPE	NGK	N° STOCK	COUL.	R (kΩ)	Ø Bougie (mm)	CONNEXION
	VD	VD05EMH	7744	Noir	5 kΩ	10-12	
		VD05FMH	8425	Noir	5 kΩ	10-12	

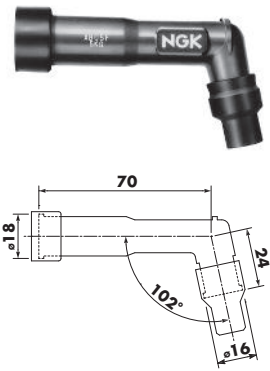
Caoutchouc (silicone)	TYPE	NGK	N° STOCK	COUL.	R (kΩ)	Ø Bougie (mm)	CONNEXION
	VD	VD05FML	8427	Noir	5 kΩ	10-12	

Résine Phénolique	TYPE	NGK	N° STOCK	COUL.	R (kΩ)	Ø Bougie (mm)	CONNEXION
	XB	XB01F	8431	Noir	1 kΩ	14	
		XB05F	8062	Noir	5 kΩ		
		XB05F-R	8592	Rouge	5 kΩ		
		XB10F	8436	Noir	10 kΩ		
	XD	XD01F	8439	Noir	1 kΩ	10-12	
		XD05F	8072	Noir	5 kΩ		
		XD05F-R	8768	Rouge	5 kΩ		
		XD10F	8442	Noir	10 kΩ		
	XZ	XZ01F	8443	Noir	1 kΩ	10-12-14	
		XZ05F	8444	Noir	5 kΩ		







Résine Phénolique		TYPE	NGK	N° STOCK	COUL.	R (kΩ)	Ø Bougie (mm)	CONNEXION
	XB	XB05FP	8435	Noir	5 kΩ	14		
	XD	XD05FP	8641	Noir	5 kΩ	10-12		

Résine Phénolique		TYPE	NGK	N° STOCK	COUL.	R (kΩ)	Ø Bougie (mm)	CONNEXION
	YB	YB01F	8446	Noir	1 kΩ	14		
		YB05F	8082	Noir	5 kΩ			
		YB05F-R	33169	Rouge	5 kΩ			
		YB10F	8449	Noir	10 kΩ			
	YD	YD01F	8450	Noir	1 kΩ	10-12		
		YD05F	8454	Noir	5 kΩ			
		YD05F-R	33170	Rouge	5 kΩ			

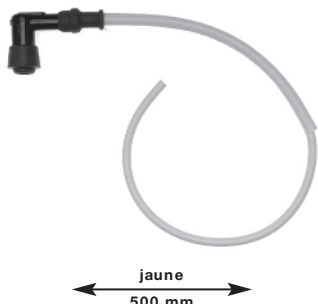
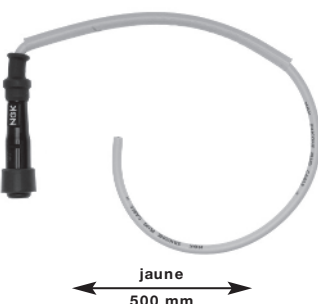
RACCORD

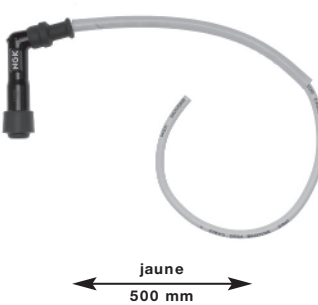
SCHEMA	TYPE	NGK	N° STOCK	COUL.	R (kΩ)	Ø Bougie (mm)	CONNEXION
	Raccord	J-1	8739	Noir	/	/	/

ANTIPARASITES AVEC CÂBLES

SCHÉMA	TYPE	NGK	N° STOCK	COUL.	R (kΩ)	Ø Bougie (mm)	CONNEXION
<p>Résine Phénolique</p>  <p>jaune 500 mm</p>	LZ05F	LY11	8718	Rouge	5 kΩ	10-12-14	
<p>Résine Phénolique</p>  <p>jaune 500 mm</p>	SZ05F	SY11	8539	Rouge	5 kΩ	10-12-14	
<p>Résine Phénolique</p>  <p>jaune 500 mm</p>	XZ05F	XY11	8584	Rouge	5 kΩ	10-12-14	
<p>Résine Phénolique</p>  <p>Rouge 500 mm</p>	SD05FMC	SD05FMC	8393	Noir	5 kΩ	10-12	
<p>Résine Phénolique</p>  <p>Noir 350 mm</p>	LD05EAK	RC-X140	5937	Noir	5 kΩ	10-12	

ANTIPARASITES DE COMPÉTITION

TYPE	NGK	N° STOCK	COUL.	R (kΩ)	Ø Bougie (mm)	CONNEXION
TRS	TRS1225-B	8787	Bleu	5 kΩ	14	Spécial Bougie R7282-__

Caoutchouc (silicone)

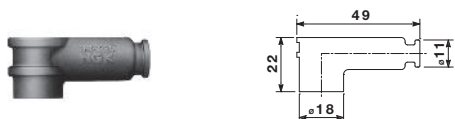

TYPE	NGK	N° STOCK	COUL.	R (kΩ)	Ø Bougie (mm)	CONNEXION
TRS	TRS1233B-Y	8897	Jaune	5 kΩ	14	Spécial Bougie R7282-__
	TRS1233C-G	8546	Vert	5 kΩ	14	
	TRS1233A-R	8929	Rouge	5 kΩ	14	

Caoutchouc (silicone)



TYPE	NGK	N° STOCK	COUL.	R (kΩ)	Ø Bougie (mm)	CONNEXION
TRS	TRS1408F-B	8871	Bleu	5 kΩ	14	Spécial Bougie R5300A-__ R5300N-__

Caoutchouc (silicone)

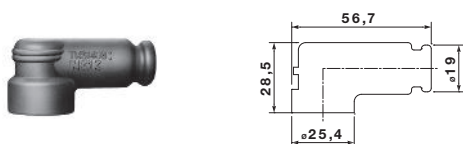

TYPE	NGK	N° STOCK	COUL.	R (kΩ)	Ø Bougie (mm)	CONNEXION
TRS	TRS1409-R	8733	Rouge	5 kΩ	14	Spécial Bougie R5540F-__

Caoutchouc (silicone)

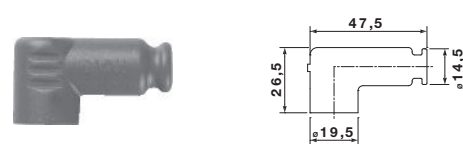

CÂBLES RACING



CARACTÉRISTIQUES

- Conducteur en fil de cuivre
- Résistance en céramique de 5 kΩ
- Gaine et capuchon moulés en silicone
- Conception étanche

AVANTAGES

- Puissance d'allumage maximale
- Antiparasitage parfait
- Résistance à la chaleur
- Étanchéité optimisée

TYPE	NGK	N° STOCK	COUL.	R (kΩ)	Ø Bougie (mm)	CONNEXION
CR	CR1	8035	Rouge	5 kΩ	10-12-14	
	CR3	8089	Rouge	5 kΩ		

Silicone

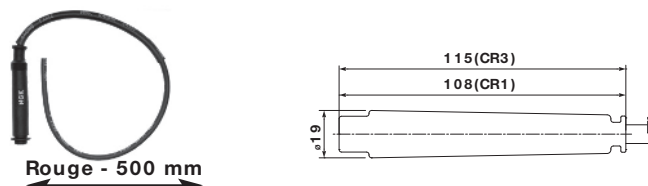

CR	CR2	8048	Rouge	5 kΩ	10-12-14	
	CR4	8054	Rouge	5 kΩ		
	CR5	8515	Rouge	5 kΩ		
	CR6	8736	Rouge	5 kΩ		

Silicone



CAPUCHONS ANTIPARASITES



CYL. MODÈLES



N° N°
STOCK BLISTER



APRILIA

CYL.	MODÈLES			N° STOCK	N° BLISTER
50	AF1 50	86-	LB05F	8051	03
50	Amico 50 LX / GL	-	LB10F	8358	02
50	Classic 50	-	LB05EPK	8342	-
50	ET 50 AE / Fire	87-	LB05F	8051	03
50	GL 50	93-	LB05F	8051	03
50	Gulliver 50	-	LB05EPK	8342	-
50	Gulliver LC Liquide	97-	LB05EPK	8342	-
50	LX 50	93-	LB05F	8051	03
50	Rally 50	-	LB05F	8051	03
50	Rally Liquide	97-	LB05F	8051	03
50	RC 50	79-82	LB05F	8051	03
50	Red Rose 50	87-	LB05F	8051	03
50	RS 50 Extrema / Replica	93-	LB05F	8051	03
50	RX 50	90-	LB05F	8051	03
50	RX 50	96-98	LB05EPK	8342	-
50	Scarabeo 50 2 Tps	93-03	LB05EPK	8342	-
50	Scarabeo De Luxe (PF)	98-03	LB05F	8051	03
50	Scarabeo 50 Street	05-	LB05EPK	8342	-
50	Scarabeo One 50 2T Street	08-	LB05EPK	8342	-
50	Sonic	-	LB05F	8051	03
50	Sportcity One 50 2T Street	08-	LB05EPK	8342	-
50	SR 50	-	LB05F	8051	03
50	SR 50 Liquide Stealth	96-	LB05F	8051	03
50	SR 50 WWW (Air)	96-	LB05F	8051	03
50	SR Liquide Netscaper	-	LB05F	8051	03
50	SR Racing (liquide)	96-	LB05F	8051	03
50	Tuareg 50	87-	LB05F	8051	03
125	Classic 125	-85	TB05EMA	8636	-
125	Europa 125, Extrema 125	-	LB10F	8358	02
125	Leonardo 125	-	SD05F-R	8238	-
125	Mojito Custom	02-	LB05E	8031	01
125	Mojito PM / RY	05-	LB05E	8031	01
125	Pegaso 125	-	LB10F	8358	02
125	RS Sport Pro 125	-	TB05EMA	8636	-
125	RX 125	90-	LB05F	8051	03
125	Scarabeo 125 i.e.	09-	V05E	6665	-
125	Scarabeo 125 GT	02-	V05E	6665	-
125	Sportcity VB	05-	LB05E	8031	01
125	Sport City One	08-	V05E	6665	-
150	Leonardo 150	98-	SD05F-R	8238	-
150	Leonardo ST	02-06	LB05E	8031	01
150	Mojito	03-06	LB05E	8031	01
200	Scarabeo 200	00-09	V05E	6665	-
200	Scarabeo 200 i.e.	09-	V05E	6665	-
200	Sport City Cube 200	08-	V05E	6665	-
250	Scarabeo 250	04-	V05E	6665	-
278	Scarabeo 300 Special	09-	V05E	6665	-
278	Sport City Cube 300	08-	V05E	6665	-
450	RXV 4.5	07-	VD05EMH	7744	-
450	SXV 4.5	07-	VD05EMH	7744	-
500	Scarabeo 500	02-	V05E	6665	-

CYL. MODÈLES



N° N°
STOCK BLISTER

CYL.	MODÈLES			N° STOCK	N° BLISTER
550	RXV 5.5	07-	VD05EMH	7744	-
550	SXV 5.5	07-	VD05EMH	7744	-
850	Mana 850	07-	VD05EMH& VD05EM	7744& 8422	-
850	Mana GT 850	09-	VD05EMH& VD05EM	7744& 8422	-



BETA

80	EVO 80 / Junior	08-	LB05EMH-R	8160	-
250	EVO 250 4T	08-	VD05EG	5817	-
300	EVO 300 4T	08-	VD05EG	5817	-



BMW

475	R 45 [27ch] & [35ch]	78-85	LB05F	8051	03
500	R 50/5	-	LB05F	8051	03
600	R 60/5, 60/6, 60/7	-78	LB05F	8051	03
650	R 65 / R65 LS	78-	LB05F	8051	03
750	R 75/5, 75/6, 75/7	-	LB05F	8051	03
800	R 80/7N / 7S	77-80	LB05F	8051	03
800	R 80 / GS / ST / RT / R	82-95	LB05F	8051	03
850	R 850 GS / RT	98-	LB05F	8051	03
850	R 850 R	94-	LB05F	8051	03
900	R 90/6 / S / 6	-	LB05F	8051	03
980	R 100, CS, GS, RS, RT, S, T	80-87	LB05F	8051	03
980	R 100/7	-	LB05F	8051	03
1000	R 100	-	LB05F	8051	03
1000	R 100 R	94-	LB05F	8051	03
1000	R 100 RS	86-	LB05F	8051	03
1000	R 100/7	-	LB05F	8051	03
1000	R 100/CS/RT	-	LB05F	8051	03
1000	R 100/RS	-86	LB05F	8051	03
1000	R 100 GS	86-	LB05F	8051	03
1000	R 100/S/T	76-80	LB05F	8051	03
1100	R 1100 GS 59kW	93-99	LB05F	8051	03
1100	R 1100 RS 66kW	92-	LB05F	8051	03
1100	R 1100 RT 66kW	95-	LB05F	8051	03
1100	R 1100 R	94-	LB05F	8051	03



BOMBARDIER - Quad

-	Tout type	-	VD05FMH	8425	-
---	-----------	---	---------	------	---



CAGIVA

125	RX 125	-	LB05F	8051	03
125	WMX 125 / 84-85-88	-	LB05F	8051	03
175	Tous modèles	-	LB05F	8051	03
200	Tous modèles	-	LB05F	8051	03
250	MX / MXR / RR / RX / WMX	-	LB05F	8051	03
250	NC / RL / SS / SST	83-	LB05F	8051	03

CYL.	MODÈLES	0201		N° N°	
				STOCK	BLISTER
250	RX 250 Rally	79-83	LB05F	8051	03
250	SX / SXT	83-84	LB05F	8051	03
350	Ala Blu 350 / Alazzurra 350	-	LB05F	8051	03
350	Ala Rossa 350 / 4T / Verde	83-	LB05F	8051	03
350	Elefant 350(D) / Lucky / SST	-	LB05F	8051	03
350	W12	94-	SD05FP	8325	-
600	W16	94-	SB05F	8080	-

**CCF**

50	Cat 50	97-	LB05FP	8030	-
----	--------	-----	--------	------	---

**DAELIM**

125	Daystar	00-	XB01F	8431	-
125	VC, VS Advance / Evolution	95-	XB01F	8431	-
125	VT 125 Evolution	98-	XB01F	8431	-

**DERBI**

250	GP1 250 / Racing	07-	V05E	6665	-
250	Rambla 250	-	V05E	6665	-

**DUCATI**

600	Pantah 600	81-	VB05F	8032	-
900	SS, SD, GTS, SD, S2, HR	80-87	VB05F	8032	-

**ENFIELD**

500	Bullet 500	-	LB05F	8051	03
-----	------------	---	-------	------	----

**GAS GAS**

125	TT 125	-	LB05F	8051	03
200	TT 200	-	LB05F	8051	03
250	Cross 250, TT 250	-	LB05F	8051	03
300	TT 300	-	LB05F	8051	03

**GILERA**

50	CB1 4V / Trial	-	LB05F	8051	03
50	RK / Eaglet	-	LB05E	8031	01
50	Runner / Stalker	97-	LB05E	8031	01
50	TS / Touring	73-82	LB05F	8051	03
98	Giubileo 4 T / SS	-	LB05F	8051	03
125	Arcore / Export	72-80	LB05F	8051	03
125	Runner FX	97-	LB05E	8031	01
125	SV Regolarità	-	LB05F	8051	03
300	Nexus 300	09-	V05E	6665	-
500	Fuoco	07-	V05E	6665	-
500	Nexus	04-	V05E	6665	-
500	Saturno	88-92	LB05F	8051	03
800	GP 800	07-	VD05EMH & VD05EM	7744 & 8422	-



CYL.	MODÈLES	0201		N° N°	
				STOCK	BLISTER



**HERCULES**

50	City Bike C1 / C2 / C3	72-78	LB05F	8051	03
50	Hobby Rider HR 1 / HR2	72-87	LB05F	8051	03
50	Jogging	-	LB05F	8051	03
50	K 50, Ultra, II, LC, LCII, LCIII	-78	LB05F	8051	03
50	KX 5	86-	LB05F	8051	03
50	Lastboy	-	LB05F	8051	03
50	M1, M2, M4, M5, MP2, MP4	72-78	LB05F	8051	03
50	MK 1S / MK 2S	78-80	LB05F	8051	03
50	MX 1 / MX2	-	LB05F	8051	03
50	Optima 3	78-	LB05F	8051	03
50	Optima 50	-	LB05F	8051	03
50	Prima Tous types	-	LB05F	8051	03
50	Sport Bike SB1, 2, 3, 5	72-79	LB05F	8051	03
50	Supra 2D, 3D, 4/GP, Enduro	80-	LB05F	8051	03
50	XE 5	86-	LB05F	8051	03
50	ZX 1	-	LB05F	8051	03
80	RX 9 / Ultra 80 / XE9	-	LB05F	8051	03
100	K 100 X	-	LB05F	8051	03
125	K 125	-	LB05F	8051	03
175	GS	-	LB05F	8051	03
250	GS	-	LB05F	8051	03
350	GS	-	LB05F	8051	03



**HONDA**

50	Camino PA 50	75-87	LB05F	8051	03
50	CB 50	-	LD05F-R	8231	-
50	CB 50 Y	73-83	LD05F-R	8231	-
50	CD 250 U	-	XD05F-R	8768	-
50	CY 50	81-	LD05F-R	8231	-
50	CR 50 R D / E / F	83-	LB05EMH-R	8160	-
50	Elite 50 / S	-	LB05F	8051	03
50	Joker SRX50T	97-	LB05F	8051	03
50	MB 50 F / S (AC01)	-	LB05F	8051	03
50	MBX 50 M / S / SD (AC05)	-	LB05EMH-R	8160	-
50	MR 50	-	LB05F	8051	03
50	MT 50 F / S (AD04)	-	LB05F	8051	03
50	MTX 50 E / G / J / R	84-	LB05EMH-R	8160	-
50	NB 50 M Melody de Luxe E	84-	LB05F	8051	03
50	NB 50 M Vision F	85-	LB05F	8051	03
50	NC 50	-	LB05F	8051	03
50	NCZ 50 B	81-	LB05F	8051	03
50	ND 50 Melody C	82-	LB05F	8051	03
50	NE 50	-	LB05F	8051	03
50	NH 50 Lead F / H / J	85-87	LB05F	8051	03
50	NH 50 M	93-	LB05F	8051	03
50	NSR 50	89-	LB05F	8051	03
50	NSR 50 A K	89-	LB05F	8051	03
50	NT 50 / NX 50 / NX 50 M	-	LB05F	8051	03
50	PA 50	84-	LB05F	8051	03
50	PA50 STD-VLS	77-	LB05F	8051	03
50	PA50 Sport DX Camino	77-	LB05F	8051	03
50	PF 50	-	LB05F	8051	03
50	PK 50 DX (AB25)	95-	LB05F	8051	03
50	PK 50 STD / DX L	90-	LB05F	8051	03
50	PK 50 P / R	93-	LB05F	8051	03

CYL.	MODÈLES			N° STOCK	N° BLISTER
HONDA					
50	PK 50 Wallaroo	90-	LB05F	8051	03
50	PM 50	-	LB05F	8051	03
50	PX 50	84-	LB05F	8051	03
50	PX 50 E	80-	LB05F	8051	03
50	PX 50 R	85-	LB05F	8051	03
50	PX 50	89-90	LB05F	8051	03
50	PXR 50 H / PX 50 S H	87-	LB05F	8051	03
50	PZ 50	-	LB05F	8051	03
50	QR 50 D / F / M / R / V	83-	LB05F	8051	03
50	RTL 50 SF H	87-	LB05F	8051	03
50	SA 50 / SE 50	-	LB05F	8051	03
50	SA 50 Vision Met-in J	88-	LB05F	8051	03
50	SA 50 II Vision Met-in P / R	93-	LB05F	8051	03
50	SFX 50 S / T / V	95-	LB05F	8051	03
50	SFX 50	96-	LB05F	8051	03
50	SGX 50 Sky V	97-	LB05F	8051	03
50	SH 50	84-	LB05F	8051	03
50	SH 50 T (AF40)	96-	LB05F	8051	03
50	SH 50 H	-	LB05F	8051	03
50	SH 50 Scoopy P / R / T	-	LB05F	8051	03
50	SJ 50 Bail P / R / S / T / V	-	LB05F	8051	03
50	SRX 50 Shadow W	-	LB05F	8051	03
50	SXR 50 W	98-	LB05F	8051	03
50	ST 50 C (AB23) Dax	-	LD05F-R	8231	-
50	TLM 50 / 50 F	-	LB05EMH-R	8160	-
50	XL 50	80-	LD05F-R	8231	-
50	XR 50	-02	LD05F-R	8231	-
50	Z 50 GZ	80-84	LD05F-R	8231	-
50	Z 50 J	-	LD05F-R	8231	-
50	Z 50 JJ M	-	LD05F-R	8231	-
50	Z 50 R	94-	LD05F-R	8231	-
50	Z 50 R C / F	-	LD05F-R	8231	-
50	ZB 50 P (AB22)	88-	VD05F-R	8376	-
50	ZB 50 J	-	VD05F-R	8376	-
60	CR 60 R D / E / F / G	-	LB05F	8051	03
70	ATC 70 E / F / D	-	VD05F-R	8376	-
70	C 70 DMC	-	LD05F-R	8231	-
70	CT 70	92-	LD05F-R	8231	-
70	ST 70 Dax C / K / T	-	LD05F-R	8231	-
70	ST 70 L / N / R / T	94-	LD05F-R	8231	-
70	TRX 70 H	-	LD05F-R	8231	-
70	XR 70 R V	-	LD05F-R	8231	-
75	NS-1	96-	LB05F	8051	03
80	CR 80 R	81-	LB05EMH-R	8160	-
80	CR 80 RB T / V / W	96-	LB05F	8051	03
80	CR 80 RII F / G	85-	LB05F	8051	03
80	CY 80	-	LD05F-R	8231	-
80	MB 80 S A	80-	LB05F	8051	03
80	MBX 80 SWD F	85-	LB05F	8051	03
80	MCX 80 (HC05)	80-	LB05F	8051	03
80	MT 80 F	-	LB05EMH-R	8160	-
80	MT 80 S A	80-	LB05F	8051	03
80	MTX80 C, R, RII, RS	82-	LB05EMH-R	8160	-
80	MTX 80 RS D / E	83-	LB05F	8051	03
80	NH 80 MS D / G / N / P / R	83-	LB05F	8051	03
80	NSR 80	-	LB05F	8051	03
80	SH 80 E Scoopy	84-	LB05F	8051	03
80	XR 80 R M / P / R / S	91-	LD05F-R	8231	-
90	EZ 90 Cub M	91-	LB05F	8051	03
90	NH 90 M / Yupy	90-	LB05F	8051	03
90	SRX 90 Shadow W	98-	LB05F	8051	03
90	TRX 90 (ATV)	93-	LD05F-R	8231	-
100	SH 100 Scoopy T	96-	LB05F	8051	03
100	SJ 100 EX Baly T / V	96-	LB05F	8051	03
100	XR 100R M, P, R, S, T, V, W	91-	VD05F-R	8376	-
110	ATC 110 C / D	82-	VD05F-R	8376	-
110	CG 110	-	LD05F-R	8231	-
125	ATC 125 ME / F / G / H	84-	LD05F-R	8231	-
125	CA 125 Rebel S / T / V / W	95-	LD05F-R	8231	-
125	CB 125 N / CB 125 J	76-	LD05F-R	8231	-
125	CB 125 T, CB 125 TII A / B	80-	LD05F-R	8231	-

CYL.	MODÈLES			N° STOCK	N° BLISTER
125	CB 125 TD J	88-	LD05F-R	8231	-
125	CG 125 BR J	88-	LD05F-R	8231	-
125	CG 125 K1, B, E, N, R, S, T	77-	LD05F-R	8231	-
125	CH 125 Spacy	83-	LD05F-R	8231	-
125	CH 125 Spacy (JS03)	97-	LD05F-R	8231	-
125	CLR 125 Cityfly (JD18A/B)	98-	VD05FMH	8425	-
125	CM 125 C C / F / J	82-	LD05F-R	8231	-
125	CM 125 C Custom N / P / R	92-	LD05F-R	8231	-
125	CM 125 T	78-	LD05F-R	8231	-
125	CR 125 R	79-	LB05F	8051	03
125	CRM 125	-	LB05F	8051	03
125	CRM 125 R L / P / R / V	90-	LB05F	8051	03
125	Italia 125	-	LD05F-R	8231	-
125	Lead 125 (JF01)	-	LB05F	8051	03
125	MBX 125 FE	84-	SD05FM-R	8673	-
125	MBX 125 F2 F	85-	SD05FM-R	8673	-
125	MTX 125 R2 H	87-	LB05F	8051	03
125	MTX 125 RW D / F	83-	LB05F	8051	03
125	MTX 125 RW F2 F	85-	LB05F	8051	03
125	NH 125	-	LB05F	8051	03
125	NH 125 Lead D / G	83-	LB05F	8051	03
125	NS 125 R	-	LB05F	8051	03
125	NS 125 R2 H	87-	LB05F	8051	03
125	NSR 125 R K / P / R / V	89-	LB05F	8051	03
125	NX 125 Transcity K, R, S, V	89-	LD05F-R	8231	-
125	Spacy CH 125 (JS03)	97-	LD05F-R	8231	-
125	TL 125 D / J	83-	VD05F-R	8376	-
125	TRAX 125 (ATV)	-	LD05F-R	8231	-
125	TRX 125 F / G / J	85-	VD05F-R	8376	-
125	XL 125 R A / B / C / F / H	80-	VD05FMH	8425	-
125	XL 125 S Z / A / B / C / F / H	79-	LD05F-R	8231	-
125	XL 125 Varadéro	01-	XY11	8584	-
125	XLR 125 R	98-	VD05FMH	8425	-
125	XR 125	-	LD05F-R	8231	-
185	ATC 185 S A / B / C / D	80-	LD05F-R	8231	-
185	CD 185 T / CM 185 T	-	LD05F-R	8231	-
185	XL 185 S	79-	VD05F-R	8376	-
200	CB 200 B	81-	LD05F-R	8231	-
200	CD 200 T / CM 200 T	-	LD05F-R	8231	-
200	MTX 200 RW	83-	LB05EMH-R	8160	-
200	TRX 200 SX G / H / J	86-	LD05F-R	8231	-
200	TRX 200 M	91-	LD05F-R	8231	-
200	TRX 200 D S / T / V	95-	LD05F-R	8231	-
200	XL 200 R D	83-	VD05F-R	8376	-
250	CB 250 / N / RS (MC26)	-	XD05F-R	8768	-
250	CB 250 N A / B	80-	XD05F-R	8768	-
250	CB 250 RS Z / A / C	79-	XD05F-R	8768	-
250	CB 250 T	-	LD05F-R	8231	-
250	CBR 250 R	-	SD05F-R	8238	-
250	CBX 250	-	SD05FM-R	8673	-
250	CD 250 U	-	XD05F-R	8768	-
250	CH 250	-	VD05F-R	8376	-
250	CM 250 C Custom	82-	XD05F-R	8768	-
250	CMX 250 C Rebel T / V	96-	VD05F-R	8376	-
250	CMX 250 CT (MC13)	96-	VD05F-R	8376	-
250	CN 250 Spazio J / R / V	88-	VD05F-R	8376	-
250	CN 250 / Fusion / Helix	86-99	VD05F-R	8376	-
250	CR 250 R	78-02	LB05F2 ou CR2	8051 ou 8048	03
250	NX 250 II P	93-	VD05F-R	8376	-
250	NX 250 J / K / L (MD21)	88-	VD05F-R	8376	-
250	NX 250 J / L / 2L	88-	VD05F-R	8376	-
250	Spacy (I)	-	LD05F-R	8231	-
250	TLR 250	-	VD05FMH	8425	-
250	TLR 250 F	88-	VD05FMH	8425	-
250	TRX 250 H	87-	VD05F-R	8376	-
250	VT 250 F2	-	SD05FMC	8393	-
250	XL 250 R	-	SD05F-R	8238	-
250	XL 250 R / L (MD11)	-	SD05F-R	8238	-
250	XL 250 S Z / A / B	79-	SD05F-R	8238	-
250	XR 250 L	92-	SD05F-R	8238	-
350	XL 350 R E / F / H	84-	VD05F-R	8376	-
350	XR 350 R D / E / F / G	83-	VD05F-R	8376	-

CYL.	MODÈLES			N°	
				STOCK	BLISTER
400	CB-1 (NC27)	91-	SD05F-R	8238	-
400	CB 400 A	79-	VD05F-R (IN) XD05F-R (OUT)	8376 8768	-
400	CB 400 N A / B	80-	XD05F-R	8768	-
400	CB 400 T A / B / C	80-	YB05F	8082	-
400	CBR 400 F	-	SD05F-R	8238	-
400	CBX 400 F / F2 C	82-	SD05FMC	8393	-
400	CM 400 T	80-84	XD05F-R	8768	-
400	XR 400 R T / V / W	96-	SD05F-R	8238	-
450	CB 450 N (PC14)	85-	LB05F	8051	03
450	CB 450 S (PC17)	86-88	XD05F-R	8768	-
450	CMX 450 C	-	XD05F-R	8768	-
450	CR 450 R B	81-	LB05F	8051	03
480	CR 480 R C / D	82-	LB05F	8051	03
500	CB 500 R / T / V / VF 500 F	94-	SD05F-R (IN) XD05F-R (OUT)	8238 8768	-
500	FT 500 (PC07)	82-85	VD05F-R	8376	-
500	GB 500 (PC16)	92-	SD05F-R	8238	-
500	VF 500 F / F2 (PC12)	84-	SD05FMC	8393	-
500	VT 500 C D / E	83-	VD05F-R	8376	-
500	XR 500 - XL 500 R / S	-	VD05F-R	8376	-
550	CB 550 (FI / FII)	71-87	SD05F-R (IN) XD05F-R (OUT)	8238 8768	-
550	CBX 550 F / FII D	83-	SD05FMC	8393	-
600	CBR 600 F	87-00	CR1	8035	-
600	CBR 600 F (PC23)	89-90	CR1	8035	-
600	CBR 600 F2 (PC25)	93-94	CR1	8035	-
600	CBR 600 F3 (PC31)	95-98	CR1	8035	-
600	CBX 600 E	83-87	SD05FMC	8393	-
600	NTV 600	-	SD05F-R (IN) VD05F-R (OUT)	8238 8376	-
600	XL 600 L / LM / R / RM	-	SD05FM-R	8673	-
600	XL 600 V Transalp P, R, T, V	-	SD05F-R	8238	-
600	XR 600 R / L	85-	SD05FM-R	8673	-
650	CB 650 C A / B	80-	XD05F-R	8768	-
650	CB 650 SC C	82-	XD05F-R	8768	-
650	CB 650 Z / B	79-	XD05F-R	8768	-
650	CBX 650 E (RC13)	83-	SD05FMC	8393	-
650	FMX 650	05-	SD05F-R	8238	-
650	NX 650 Dominator / Transalp	88-	SD05F-R	8238	-
650	Transalp XL 650	94-	SD05F-R	8238	-
650	NT 650	98-04	SD05FGA	8683	-
650	NTV 600	88-92	SD05FGA	8683	-
650	NTV 650	98-04	SD05FGA	8683	-
650	VT 600	92-99	SD05FGA	8683	-
650	VT 750	97-02	SD05FGA	8683	-
650	XRV 650	88-89	SD05FGA	8683	-
650	XL 600 Transalp	93-06	SD05FGA	8683	-
650	XL 650L	94-	SD05F-R	8238	-
650	XRV 750	90-03	SD05FGA	8683	-
750	CB 750 C B / K / KZ	81-	SD05F-R	8238	-
750	CB 750 F A / B / C	80-	SD05F-R	8238	-
750	CB 750 F2 C	82-	SD05F-R	8238	-
750	CB 750 F2 7-50 N, R, S, T, V	92-97	SD05F-R	8238	-
750	CB 750 F2 N / FI	91-	SD05F-R (IN) XD05F-R (OUT)	8238 8768	-
750	CB 750 Four I	-	SD05F-R	8238	-
750	CB 750 KZ / A / B	79-	SD05F-R	8238	-
750	NR 750 (RC40)	93-	SD05F-R	8238	-
750	RVF 750 R (RC45) R / S	94-	SD05F-R	8238	-
750	VF750C (RC43) P, R, S, T, V	93-00	SD05F-R	8238	-
750	VF 750 C Magna	94-95	CR1	8035	-
750	VF 750 F (RC15)	83-84	CR1	8035	-
750	VF 750 S C / D / F	82-83	SD05F-R	8238	-
750	VFR 750 F, FJ	86-	XD05F-R	8768	-
750	VT 750 C / C2V	97-	XD05F-R (IN) VD05F-R (OUT)	8768 8376	-
800	PC 800 K	89-	SD05F-R	8238	-
800	PC 800 Pacific Coast	98-	SD05F-R	8238	-
900	CB 900 F Z / A / B / C	79-	SD05F-R (IN) XD05F-R (OUT)	8238 8768	-
900	CB 900 F2 B/C	81-	SD05F-R (IN) XD05F-R (OUT)	8238 8768	-
900	CBR 900 RR Fireblade N, P	96-	XD05F-R	8768	-

CYL.	MODÈLES			N°	
				STOCK	BLISTER
900	CBR 900 RR Fireblade R	96-	XD05F-R	8768	-
900	CBR 900 RR Fireblade S, T	96-	XD05F-R	8768	-
900	CBR 900 RR Fireblade V, W	96-	XD05F-R	8768	-
1000	CB 1000 F P / R / S / T / V	93-	SD05F-R (IN) XD05F-R (OUT)	8238 8768	-
1000	CBR 1000 F	88-00	SD05F-R (IN) XD05F-R (OUT)	8238 8768	-
1000	GL 1000 LTD K1 / K2	75-	XD05F-R	8768	-
1000	VF 1000 F E	84-	SD05FMC	8393	-
1000	VF 1000 F2 F	85-	SD05FMC	8393	-
1000	VF 1000 R E / G	84-	SD05FMC	8393	-
1050	CBX 1000 (CB1)	-	XD05F-R	8768	-
1100	CB 1100 F D	83-	XD05F-R	8768	-
1100	CB 1100 R B / C / D	81-	SD05F-R (IN) XD05F-R (OUT)	8238 8768	-
1100	GL 1100 D / DX / R	80-	XD05F-R	8768	-
1100	VF 1100 C (SC12)	83-	SD05FMC	8393	-
1200	GL 1200 (SC14)	84-87	XD05F-R	8768	-



HONDA - Quad

70	ATC 70	73-85	VD05F-R	8376	-
70	TRX 70	86-87	VD05F-R	8376	-
70	TRX 70	-	LD05F-R	8231	-
90	ATC 90	70-78	VD05F-R	8376	-
90	TRX 90	93-00	LD05F-R	8231	-
110	ATC 110	79-85	VD05F-R	8376	-
125	ATC 125M	-	LD05F-R	8231	-
125	ATC 125M	84-87	VD05F-R	8376	-
125	TRAX 125	-	LD05F-R	8231	-
125	TRX 125	85-88	VD05F-R	8376	-
185	ATC 185	80-83	VD05F-R	8376	-
185	ATC 185S	80-83	VD05F-R	8376	-
185	ATC 185	-	LD05F-R	8231	-
185	ATC 185S	-	LD05F-R	8231	-
200	ATC 200 B / C / D	81-	LD05F-R	8231	-
200	ATC 200 ES F	85-	VD05F-R	8376	-
200	ATC 200 S E / F	84-	VD05F-R	8376	-
200	ATC 200 X D / E / F / G / H	83-	VD05F-R	8376	-
200	ATC 200	81-87	VD05F-R	8376	-
200	ATC 200ES	82-84	VD05F-R	8376	-
200	ATC 200M	84-85	VD05F-R	8376	-
200	ATC 200S	84-86	VD05F-R	8376	-
200	ATC 200X	86-87	VD05F-R	8376	-
200	TRX 200D	84-97	VD05F-R	8376	-
250	ATC 250ES / SX	85-87	VD05FMH	8425	-
250	ATC 250 ES G / H / J	86-	VD05F-R	8376	-
250	ATC 250R	81-84	LB05EMH-R	8160	-
250	FL 250	77-84	LD05F-R	8231	-
250	FL 250	77-84	LB05F	8051	03
250	TRX 250 X / R	85-92	VD05FMH	8425	-
250	TRX 250 X / R	-	VD05F-R	8376	-
350	TRX 350	86-00	VD05FMH	8425	-
350	TRX 300 / FW	88-00	VD05FMH	8425	-
400	TRX 400EX	99-01	LB05EMH-R	8160	-



HUSABERG

400	FC 400	-	SD05F-R	8238	-
400	FE 400 / E / S	-	SD05F-R	8238	-
400	FX 400 E	-	SD05F-R	8238	-
500	FC 501	95-	SD05F-R	8238	-
500	FE 501 / E / S	93-	SD05F-R	8238	-
500	FX 501 E	-	SD05F-R	8238	-
600	FC 600	92-	SD05F-R	8238	-
600	FE 600 / E / S	92-	SD05F-R	8238	-
600	FX 600 E	-	SD05F-R	8238	-

CYL. MODÈLES



N° STOCK N° BLISTER



HUSQVARNA

250	CR 250	01-	LB05F	8051	03
250	WR 250	01-	LB05F	8051	03
400	410 TE (2AA)	96-00	SD05FP	8325	-
400	TE 410	01-	SD05FP	8325	-
570	SM 570 R	01-	SD05FP	8325	-
576	TC 570 / TE 570	01-	SD05FP	8325	-
610	TE / TC	98-	SD05FP	8325	-
610	SM 610 e	98-	SD05FP	8325	-



ITALJET

50	Dragster 50	96-	LB10F	8358	02
50	Dragster Café race	03-	LB10F	8358	02
50	Fastboy	98-	LB05F	8051	03
50	Formula 50 air / watercool	98-	LB05F	8051	03
50	Torpedo 25	97-	LB10F	8358	02
125	Formula / Dragster 125	97-98	LB05F	8051	03



KAWASAKI

50	AE 50 / AR50	-	LB05F	8051	03
50	AV50 / KH50 / KMX	-	LB05F	8051	03
60	KX 60	-	LB05F	8051	03
80	AE, AN, AR, DX, KDX, KMX	-	LB05F	8051	03
80	KX 80 / AE80 / AR80	83-91	LBER-B	8308	-
80	KD80 / KH80	83-91	LBER-B	8308	-
80	KX 80 II	98-	LB05F	8051	03
90	KC 90 / A / C / D	-	LB05F	8051	03
90	KE 90 / KH 90 / KM 90	-	LB05F	8051	03
100	KC 100	80-	LB05F	8051	03
100	KD 100	-	LB05E	8031	01
100	KE 100	76-79	LB05F	8051	03
100	KE 100	93-	LB05F	8051	03
100	KH 100	-	LB05F	8051	03
100	KM 100	79-81	LB05E	8031	01
100	KV 100	-	LB05E	8031	01
125	AR 125	82-	LB05F	8051	03
125	DX 125	-	LB05F	8051	03
125	Eliminator 125	98-	LD05F-R	8231	-
125	KC 125	-	LB05F	8051	03
125	KD / KE / KH / KS	-	LB05E	8031	01
125	KX 125	90-99	LB05EMH-R	8160	-
125	KDX 125 SR / KH125	-	LB05F	8051	03
125	KMX 125 / KMX 125 A11	86-	LB05F	8051	03
125	KX 125 / KX 125 Ichiban	82-90	LB05F	8051	03
175	KD	-	LB05F	8051	03
175	KDX	80-84	LBER-B	8308	-
175	KE B / D	-	LB05F	8051	03
200	KDX 200	93-94	LBER-B	8308	-
200	KDX 200 R / SR	-	LB05F	8051	03
200	KDX 200 H	95-	LB05EMH-R	8160	-
200	KMX 200	88-92	LB05F ou CR2	8051 8048	03
200	Z 200	77-79	LB05F	8051	03
250	BJ 250A (Estrella)	93-96	LD05F-R	8231	-
250	BJ 250C (Estrella)	97-	LD05F-R	8231	-
250	BJ 250	93-	LD05F-R	8231	-
250	EL 250	89-	LD05F-R	8231	-
250	Eliminator 250	96-	LD05F-R	8231	-
250	GPZ 250 Belt Drive	-	LD05F-R	8231	-
250	GPZ 250 R	-	LD05F-R	8231	-
250	KDX 250	-	LB05F	8051	03
250	KE 250	-	LB05E	8031	01
250	KH 250	73-79	LB05E	8031	01
250	KL 250 (KLR 250)	83-91	LD05F-R	8231	-
250	KLX 250 (KLX250E)	93-	XD05F-R	8768	-
250	KLX 250	80-84	LB05E	8031	01

CYL. MODÈLES



N° STOCK N° BLISTER

250	KLX 250	93-	XD05F-R	8768	-
250	KR-1R / 1S	-	LB05F	8051	03
250	KR 250	-	LB05F	8051	03
250	KT 250	-	LB05E	8031	01
250	KX 250	-85	LBER-B	8308	-
250	KX 250	86-92	LB05F	8051	03
250	KX 250	93-	LB05EMH-R	8160	-
250	KX 250	94-	LB05F	8051	03
250	LTD 250 Belt Drive	-	LD05F-R	8231	-
250	LX 250	-	LB05F	8051	03
250	Z 250 A / B / J / T Belt Drive	-	LD05F-R	8231	-
250	Z 250 LTD / C / D / G	-	LB05F	8051	03
250	ZR 250 / Balius	93-	SD05F-R	8238	-
300	KLX 300 R	-	LD05F-R	8231	-
300	KLF 300 B & C	88-06	LB05F	8051	03
300	Lakota (ATV)	95-	LD05F-R	8231	-
300	Mule 500 (KAF 300 A&B)	92-96	LB05F	8051	03
305	GPZ Belt Drive	83-	LD05F-R	8231	-
305	Z 305	-	LD05F-R	8231	-
400	EN 400 A	-	XD05F-R	8768	-
400	GPZ 400 F / F II	-	XD05F-R	8768	-
400	GPZ 400	-	XD05F-R	8768	-
400	KH 400	-	LB05E	8031	01
400	KLE 400	93-	XD05F-R	8768	-
400	KX 400	-	LBER-B	8308	-
400	LTD 400	-	LD05F-R	8231	-
400	Z 400	76-81	LB05F	8051	03
400	Z 400 A, B, C, D, G, H, LTD	-	LB05F	8051	03
400	Z 400 F / J / K / M	-	LD05F-R	8231	-
400	ZL 400 Eliminator	93-	XD05F-R	8768	-
400	ZR400 (Xanthus / Zephyr)	-	LD05F-R	8231	-
400	ZX 400 (Z 400-F2)	93-	LD05F-R	8231	-
440	Z 440	80-85	LB05F	8051	03
440	Z 440 H (I)	-	LB05F	8051	03
450	EN 450 A (I)	-	XD05F-R	8768	-
450	LTD 450	85-	LD05F-R	8231	-
500	EN 500	90-	XD05F-R	8768	-
500	EX 500	93-	XB05F-R	8592	-
500	KH500	-	LB05E	8031	01
500	KX 500	93-	LBER-B	8308	-
500	Z 500 / ZR 500	-	LD05F-R	8231	-
550	GPZ 550	82-92	LD05F-R	8231	-
550	LTD 550	80-85	LD05F-R	8231	-
550	Z 550	-	LD05F-R	8231	-
550	ZR 550 B Zephyr	91-	LD05F-R	8231	-
550	ZX 550 A1	-	LD05F-R	8231	-
600	GPZ 600 R	-	LD05F-R	8231	-
600	ZL 600	01.86-	LD05F-R	8231	-
600	ZX-6R Ninja	-	XD05F-R	8768	-
650	KLR 650 Tengai	93-	XD05F-R	8768	-
650	KLX 650 / R	93-96	SD05FM-R	8673	-
650	Z 650 / F-B	-	LB05F	8051	03
700	LTD 700	-	LB05F	8051	03
750	Turbo	73-86	LB05F	8051	03
750	GPX 750 / R	01.85-	SD05F-R	8238	-
750	GPZ 750 / R	01.85-	SD05F-R	8238	-
750	LTD 750 4 Cyl.	82-87	LB05F	8051	03
750	Ninja ZX-7R	92-	XD05F-R	8768	-
750	Ninja ZX-7RR	-	XD05F-R	8768	-
750	VN 750 Twin / Vulcan	-	XD05F-R (IN) LD05F-R (OUT)	8768 8231	-
750	Z 2	-	XD05F-R (IN) LD05F-R (OUT)	8768 8231	-
750	Z 750	-	LB05F	8051	03
750	ZR 750 C Zephyr	91-00	LD05FP	8070	-
750	ZR 750 D1/2 Zephyr	96-00	LD05FP	8070	-
750	ZR 750 Zephyr	91-	LD05F-R	8231	-
750	ZX 750	-	XD05F-R	8768	-
750	ZX 750 J / N1 Ninja ZX-7RR	96-	LB05FP	8030	-
750	ZX 750 P1 / P2 Ninja ZX-7R	96-	LB05FP	8030	-
750	ZXR 750	88-	XD05F-R	8768	-
750	ZXR 750 R	90-	XD05F-R	8768	-
750	ZXR 750 R (ZX750L/M)	93-	XD05F-R	8768	-

CYL.	MODÈLES		N° N°		
			STOCK	BLISTER	
900	GPZ 900 R	-	XD05F-R (IN) LD05F-R (OUT)	8768 8231	-
900	Z 1	-	SB05F (IN) YB05F (OUT)	8080 8082	-
900	Z 900	73-76	SB05F (IN) YB05F (OUT)	8080 8082	-
1000	KZ 1000 Police	93-	XB05F-R (IN) LB05FP (OUT)	8592 8030	-
1000	RX	-	SD05FM-R	8673	-
1000	Z 1000	-	LB05F	8051	03
1000	ZL / ZX 1000	86-90	SD05FM-R	8673	-
1100	ZRX / Zephyr / ZRA / B1	96-00	SD05FM-R	8673	-
1100	GPZ 1100 / Z1100	-	XB05F-R (IN) YB05F (OUT)	8592 8082	-
1100	ZR 1100	96-	SD05FM-R	8673	-
1500	VN1500 Classic, D, Tourer E	-	XD05F-R (IN) LD05FP (OUT)	8768 8070	-



KAWASAKI - Quad

110	KLF 110	87-88	LD05F-R	8231	-
110	KLT 110	83-86	LD05F-R	8231	-
160	KLT 160	85-	LD05F-R	8231	-
185	KLF 185	85-88	LD05F-R	8231	-
200	KLT 200	81-94	LB05FP	8030	-
220	KLF 220 A	88-02	LD05F-R	8231	-
250	KDX 250	-	LBER-B	8308	-
250	KDX 250 / SR	91-	LB05F	8051	03
250	KLT 250	82-85	LB05FP	8030	-
250	KSF 250	87-01	XD05F-R	8768	-
250	KXF 250	88-	LBER-B	8308	-
250	KXT 250	84-88	LBER-B	8308	-
300	KAF 300	91-97	LB05EMH-R	8160	-
300	KEF 300 A&B	95-	LD05F-R	8231	-
300	KLF 300	88-91	LD05F-R	8231	-
300	KLF 300 B&C	88-06	LB05F	8051	03
450	KAF 450	90-96	XD05F-R	8768	-
540	KAF 540	91-93	XB05F-R	8592	-
620	KAF620	93-01	LB05EMH-R	8160	-



KTM

50	Adventure	02-	TB05EMA	8636	-
50	Bora, Comet, Crazy, Foxi	-	LB05F	8051	03
50	Chrono	-	LB05F	8051	03
50	Go / K	-	LB05F	8051	03
50	GP/ GXE/ K/ ME/ MLS	-	LB05F	8051	03
50	Hobby	81-	LB05F	8051	03
50	Junior	02-	TB05EMA	8636	-
50	MMS/ MS/ RSL/ SM	-	LB05F	8051	03
50	Pony / Postmofa / Squadra	-	LB05F	8051	03
50	Senior	01-	TB05EMA	8636	-
50	Senior	-	LB05F	8051	03
50	Squadra	-	LB05F	8051	03
50	SX	08-09	TB05EMA	8636	-
50	SX Junior LC	03-	LB05EMH-R	8160	-
50	SX Pro Senior, Senior	03-	LB05EMH-R	8160	-
60	SX	98-	LB05EMH-R	8160	-
65	SX	98-00	LB05EMH-R	8160	-
65	SX	09-	LB05EMH-R	8160	-
65	SX Beta Engine	03-09	LB05EMH-R	8160	-
80	Chopper / Enduro / Bora	-	LB05F	8051	03
80	PL / RL / RLS / RLW / RS	-	LB05F	8051	03
85	SX	04-07	TB05EMA	8636	-
85	SX	08-	TB05EMA	8636	-
85	SX 17 / 14	10-	TB05EMA	8636	-
85	SX 19 / 16	10-	TB05EMA	8636	-
100	GS 100 / MC 100	73-76	LB05F	8051	03
105	SX	04-	TB05EMA	8636	-
125	Enduro	-	LB05F	8051	03
125	GS 12,7 mm / MC	-	LB05F	8051	03
125	12,7 / 19 mm / MC 125 GP	-	LB05F	8051	03

CYL.	MODÈLES		N° N°		
			STOCK	BLISTER	
125	LC2, Sting, EGS, EXC, EXE	96-	LB05EMH-R	8160	-
125	Supermoto	96-	LB05EMH-R	8160	-
175	GS 175 / MC 175	-	LB05F	8051	03
200	MXC / SX	98-	LB05EMH-R	8160	-
250	EXC Racing, Racing GS	03-	VD05EG	5817	-
250	EXC-F, Six Days	07-	VD05EG	5817	-
250	EXC, Six Days, E-Starter	10-	TB05EMA	8636	-
250	DXC / EGS / EXC / MX	-	LB05EMH-R	8160	-
250	GS 12,7 mm	-	LB05F	8051	03
250	MC 12,7 / 19 mm GP	-	LB05F	8051	03
250	SX	93-99	LB05EMH-R	8160	-
250	SX 4 Temps	05-	VD05EG	5817	-
250	SX	10-	TB05EMA	8636	-
250	SXC	99-	LB05EMH-R	8160	-
250	SXF	05-	VD05EG	5817	-
250	SX-F Factory Repl.Musq.Ed.	10-	VD05EG	5817	-
250	XC, XC-W, XCF-W, Ch.Ed.	10-	TB05EMA	8636	-
300	EGS / EXC	93-	LB05EMH-R	8160	-
300	EGS	99-	LB05EMH-R	8160	-
300	EXC / Sixt Days	99-	LB05EMH-R	8160	-
300	EXC	97-98	LB05EMH-R	8160	-
300	EXC Enduro Competition	03-	LB05EMH-R	8160	-
300	MXC	03-	LB05EMH-R	8160	-
300	SX	99-	LB05EMH-R	8160	-
360	EGS / EXC / MXC / SX	96-	LB05EMH-R	8160	-
380	EGS / EXC / SX	98-	LB05EMH-R	8160	-
400	Enduro-E	98-	SD05F-R	8238	-
400	EXC Racing	99-02	VD05F-R	8376	-
400	EXC Racing	02-	VD05EG	5817	-
400	GS 400	-	LB05F	8051	03
400	LC4 / LS-E / EGS	93-97	SD05F-R	8238	-
400	LC4	98-	SD05F-R	8238	-
400	LC4-E 400 Enduro	01-	SD05F-R	8238	-
400	LC4-E	02-	VD05EG	5817	-
400	MC 400 / MC 400 GP	-	LB05F	8051	03
400	SC, EGS-E, LES, SX, SXC	95-02	SD05F-R	8238	-
400	SX Racing, Six Days	99-02	VD05F-R	8376	-
400	SX Racing	02-	VD05EG	5817	-
450	EXC Racing GS / MXC	03-	VD05EG	5817	-
450	SMR	05-	VD05EG	5817	-
450	SX-F	07-09	VD05EG	5817	-
450	SX Racing	03-	VD05EG	5817	-
477	505 SX-F	07-	VD05EG	5817	-
500	GS 2 tps / MC 2 tps	-	LB05F	8051	03
500	GS 4 tps / MC 4 tps	-	LD05F-R	8231	-
510	525 XC Desert Racing	07-	VD05EG	5817	-
520	EXC / SX Racing / Six Days	99-02	VD05F-R	8376	-
520	EXC / SX Racing	02-	VD05EG	5817	-
525	EXC, MXC, SX Racing, SMR	03-	VD05EG	5817	-
525	EXC Racing / Racing GS	03-	VD05EG	5817	-
525	MXC Desert Racing	05-	VD05EG	5817	-
540	SXC	98-	SD05F-R	8238	-
540	SXS Racing	02-	VD05F-R	8376	-
565	560 SMR	07-	VD05EG	5817	-
600	Country / Enduro / MX	-	LD05F-R	8231	-
600	LC4 Enduro 17KW / 36KW	-87	LD05F-R	8231	-
600	LC4 EGS / EXC	93-	LD05F-R	8231	-
609	Duke	94-	LD05F-R	8231	-
609	LC4- 620 SC Supermoto	01-02	SD05F-R	8238	-
612	LC4 EXC / EGS	93-	LD05F-R	8231	-
620	LC4, EGS, EXC	93-	SD05F-R	8238	-
620	LS4, SC, SX	93-	SD05F-R	8238	-
620	LC4 Super compétition	00-02	SD05F-R	8238	-
620	Rallye / Duke / Duke-E	97-	SD05F-R	8238	-
625	Adventure R 640	98-01	SD05F-R	8238	-
625	Duke 640/ 2	98-02	SD05F-R	8238	-
625	LC4 640	98-02	SD05F-R	8238	-
625	LC4 640 Duke II	03-	SD05EG	5818	-
625	LC4 640 Hard Enduro	03-	SD05EG	5818	-
625	LC4-640/ Adventure / SM	01-02	SD05F-R	8238	-
625	LC4 SM	05-	VD05EG	5817	-
625	SMC	05-	VD05EG	5817	-

CYL. MODÈLES



N° STOCK N° BLISTER

KTM				
625	Supermoto Spezial Edition	03-	SD05EG	5818 -
625	SC	02-	SD05F-R	8238 -
625	SXC Hard Enduro	03-	SD05EG	5818 -
625	SXC Super Moto	02-	VD05EG	5817 -
640	LC4/ Duke 2	99-	SD05F-R	8238 -
640	LC4 / Super Moto	02-	SD05F-R	8238 -
640	LC4-E Six days	02-	SD05F-R	8238 -
640	LC4-E SM Prestige, Adv	02-	SD05F-R	8238 -
640	LC4 640 Duke 2	03-	SD05EG	5818 -
650	Rallye / LC4 Rallye	99-02	SD05F-R	8238 -
650	Rallye	02	VD05EG	5817 -
650	Super Moto Factory Replica	02-	SD05F-R	8238 -
660	LC4 Rallye	99-	SD05F-R	8238 -
660	SMC	05-	VD05EG	5817 -



KTM - Quad

450	XC	10-	VD05EG	5817 -
525	XC	08-	VD05EG	5817 -



KYMCO

50	Calypto 50	97-	VD05F-R	8376 -
125	Calypto 125	97-	VD05F-R	8376 -



K-ZWO

50	Cat 50	97-	LB05FP	8030 -
----	--------	-----	--------	--------



MAICO

125	GS 125 / MC 125 / SG 125	-	LBER-B	8308 -
250	Cross / Enduro	90-	LBER-B	8308 -
250	GM Star / GS / GSE / MC	94-	LBER-B	8308 -
320	320	94-	LBER-B	8308 -
400	MC 400 / GS 400	-	LBER-B	8308 -
440	440	94-	LBER-B	8308 -
490	MC 490 / GSE 490	-83	LBER-B	8308 -
500	Cross / Enduro	90-	LBER-B	8308 -
500	GS 500 / GS Star	-	LBER-B	8308 -
500	MC 500	-	LBER-B	8308 -
685	685 Gespann	94-	LBER-B	8308 -



MBK

49	41	-	LB05F	8051 03
49	51 New West, S, SL	-	LB05F	8051 03
49	51 Super, V, VL	-	LB05F	8051 03
49	88 IP/ IU / 89 / Active	-	LB05F	8051 03
49	AV 40 à 98 / Champ	-	LB05F	8051 03
49	Cady / CF / Daytona	-	LB05F	8051 03
49	EV / EW / L / S / VL / VS	-	LB05F	8051 03
49	FXK / G40 / 50 / Kw Magnum	-	LB05F	8051 03
49	Hobby IV / Mobylette	-	LB05F	8051 03
49	M 1 / L / P / R / T / S	-	LB05F	8051 03
49	N40 / 50 / Rock / Weekly	-	LB05F	8051 03
49	SP 50 à 99, X1L à X7VS, ZX	-	LB05F	8051 03
50	50 R / VL / VLC / SU	-	LB05F	8051 03
50	51 SU / V	-	LB05F	8051 03
50	89 / 93 / 98 / 99 / D50	-	LB05F	8051 03
50	151 L / LB / LC	79-83	LB05F	8051 03
50	881 P / 881 U (air) / 89 (air)	-	LB05E	8031 01
50	Active 50 / Business Class	-	LB05F	8051 03
50	Booster 50 Tous modèles	-	LB05F	8051 03
50	Champ / 88 / 89	-	LB05F	8051 03
50	Club VR Tex Mex / Swing	-	LB05E	8031 01

CYL. MODÈLES



N° STOCK N° BLISTER

50	Collection	-	LB05F	8051 03
50	D / DT 50 R / boîte 5 / DX50S	-	LB05F	8051 03
50	Equalis / Evasion / Eviolis 50	-	LB05F	8051 03
50	Fizz / Flipper / Forte	-	LB05F	8051 03
50	Hard Rock	-	LB05F	8051 03
50	Hot Champ / Jazz	-	LB05F	8051 03
50	Magnum Racing	-	LB05E	8031 01
50	Magnum Racing XR (liq.)	-	LB05E	8031 01
50	MachG (LC / AC) / Booster	-	CR2	8048 -
50	MB3V / SP3V	77-83	LB05F	8051 03
50	Monty MB3V / SP3V	77-83	LB05F	8051 03
50	Nitro / Nitro Jaguar Racing	97-	LB05F	8051 03
50	Ovetto	-	LB05F	8051 03
50	Passion / Roadster / Swing	-	LB05E	8031 01
50	SP 94 TT	-	LB05F	8051 03
50	X-Limit Boite 6 / X-Power	-	LB05F	8051 03
75	D75	-	LB05F	8051 03
80	Active / Eviolis	-	LB05F	8051 03
80	Business Class	-	LB05F	8051 03
125	125 12,7 / 19 mm	-	LB05F	8051 03
125	DT 125 R	-	LB05F	8051 03
125	Flame / Flame R	95-	LD10F	8997 -
250	250	-	LB05F	8051 03
350	350	73-79	LB05F	8051 03
350	350 E / 350 Injection	-	LB05F	8051 03



MONTESA

50	Brio / Cirlo / Fura / Mini Cota	-	LB05F	8051 03
50	Cota 25A, 25C, 49	-	LB05F	8051 03
50	Scorpion 50R	-	LB05F	8051 03
75	Cota 74 / 74T / 80	-	LB05F	8051 03
75	Crono 75	-	LB05F	8051 03
75	Enduro 75 H6 / H7 / L	-	LB05F	8051 03
123	Cota 123 / C / T, 125, 172	-	LB05F	8051 03
175	Cota 172 / 200	-	LB05F	8051 03
310	Cota 348, Trial	-	LB05F	8051 03
315	315R	97-	LB05F	8051 03
350	Cota 330 / 335 / 349 / 350	-	LB05F	8051 03
350	Crono 350	-	LB05F	8051 03
350	Enduro 360 H6 / H7 / H7S / L	-	LB05F	8051 03



MOTO GUZZI

250	250 FD	74-76	LD05F-R	8231 -
250	250 TS	74-80	LB05F	8051 03
350	V 35 II	80-87	LB05F	8051 03
350	V 35 III	85-	LB05F	8051 03
350	V 35 Imola, II	79-87	LB05F	8051 03
650	V 65 NTX	90-92	LB05F	8051 03
650	V 65 Polizia NT	-	LB05F	8051 03
650	V 65 SP	-86	LB05F	8051 03
750	V 750 Nevada	92-	LB05EPK	8342 -
850	California / Le Mans II / III	75-81	LB05F	8051 03
850	T4 / T5 / TS 5	80-87	LB05F	8051 03
1000	SP III	88-92	LB05F	8051 03
1000	Quota I.E.	-	LB05F	8051 03
1100	California Carb / Inj,	94-	LB10F	8358 02
1100	California inj,	94-	LB05F	8051 03



MOTOBECANE

Tous modèles	-	LB05F	8051 03
--------------	---	-------	---------



MOTOR HISPANIA

50	Minicross / Style	-	LB05F	8051 03
----	-------------------	---	-------	---------

**MZ**

125	Saxon Roadstar 7 / 11kW	-	LB05F	8051	03
125	Saxon Sportstar 7 / 11kW	-	LB05F	8051	03
125	TS	75-85	LB05F	8051	03
150	Saxon Roadstar 9kW	-	LB05F	8051	03
150	Saxon Sportstar 9kW	-	LB05F	8051	03
251	ETZ Classic 13 / 15kW	-	LB05F	8051	03
251	Saxon 251 Fun, Tour 13	-	LB05F	8051	03
300	Kanuni	97-	LB10F	8358	02
301	ETZ 301 Classic 17kW	-	LB05F	8051	03
301	Saxon 301 Fun / Tour 17kW	-	LB05F	8051	03

**PANDA - Quad**

50	KD50A	00-01	YB05F	8082	-
80	KD80A	00-01	YB05F	8082	-
125	KD125A	00-01	YB05F	8082	-

**PEUGEOT**

50	101 / 102 / 103 - tige filetée	75-	LB05F	8051	03
50	104 / 105 - connec. filetée	75-	LB05F	8051	03
50	101 / 102 / 103 - olive mono	-	LB05E	8031	01
50	104 / 105 - olive mono	-	LB05E	8031	01
50	Buxy / Elyseo	-	LB05FG	8346	-
50	Elystar TSDI 50	-	RC-X140	5937	-
50	Fox L / LM / SPX M	-	LB05E	8031	01
50	Jet Force C-Tech 50	05-	LB05E	8031	01
50	Jet Force 50 / TSDI	03-	RC-X140	5937	-
50	Looxor 50 TSDI	-	RC-X140	5937	-
50	RCX M / LCM	-	LB05FG	8346	-
50	Speedfight - connec. filetée	96-	LB05FG	8346	-
50	Speedfight M / LC - mono	96-	LB05E	8031	01
50	Squab / Speedake	-	LB05FG	8346	-
50	SV	96-	LB05E	8031	01
50	Trekker Road, Off Road, SV	97-	LB05E	8031	01
50	Zenith / N / LN / LS	-	LB05FG	8346	-
80	SC80L / SX8T / SV 80	-	LB05F	8051	03
100	Speedfight / SV 100	97-	LB05E	8031	01
100	SV	96-	LB05E	8031	01
125	Elystar 125	-	RC-X140	5937	-
125	Elystar ABS / PBS 125	-	RC-X140	5937	-
125	Geopolis 125	06-	RC-X140	5937	-
125	Looxor 125	-	LB05E	8031	01
125	Satelis 125 Kompressor	06-	RC-X140	5937	-
125	Satelis 125	04-	RC-X140	5937	-
150	Elystar 150	03-	RC-X140	5937	-
150	Looxor	-	LB05E	8031	01

**PGO**

50	Big Max 25/50, Sport, Comet	-	LB05F	8051	03
50	Galaxy 25 / 50 / Mega	-	LB05F	8051	03
50	PMS / PMX	-	LB05F	8051	03
50	Rodoshow / Star 2 / 50	00-	LB05F	8051	03
50	Tomado / T-Rex	00-	LB05F	8051	03
80	Star 80 / Big Max 90	-	LB05F	8051	03
125	T-REX 125 2T	99-	LB05F	8051	03
125	T-REX 125 4T	99-	YB05F	8082	-

**PIAGGIO**

25	Free 25 Mofa / Zip 25 Mofa	-	LB05F	8051	03
50	50 R / Special / S / Boss	-	LB05F	8051	03
50	Bravo / Ciao / Eaglet	-	LB05F	8051	03



50	Fly 50 4T	06-	LB05E	8031	01
50	Free 50	93-	LB05F	8051	03
50	Grillo / Mofa	-	LB05F	8051	03
50	Liberty 4T	02-05	LB05E	8031	01
50	NRG mc2 DT / DD	-	LB05F	8051	03
50	NRG Extreme, H2O Cat	-	LB05F	8051	03
50	NSP 4T (Aria)	02-	LB05E	8031	01
50	PK 50 S	82-87	LB05F	8051	03
50	PK 50 SS	-	LB05F	8051	03
50	PK 50 XL2 / Auto	-	LB05F	8051	03
50	PX 50	-	LB05F	8051	03
50	Plurimatic / PX 50	-	LB05F	8051	03
50	Quarz 50 Automatic	92-	LB05F	8051	03
50	R / Special / S	-	LB05F	8051	03
50	Sfera 50 Auto., FL, RL, RST	91-	LB05F	8051	03
50	Storm	94-	LB05F	8051	03
50	Super Bravo, Bravo 2 Gang	-	LB05F	8051	03
50	TPH / Velofax / Mofa	-	LB05F	8051	03
50	Vespa Elestart / Delta	-	LB05F	8051	03
50	Vespa Puch Condor	-	LB05F	8051	03
50	Vespa Vale Especial / Stdr	-	LB05F	8051	03
50	Vespa ET 4	02-05	LB05E	8031	01
50	Vespa HP 4M, PK50XL 2	-	LB05F	8051	03
50	Vespino NX, SC, T, TL	-	LB05F	8051	03
50	Vespino TN, TS, TX, XE	-	LB05F	8051	03
50	Zip50 Base / Fast Rider / SP	93-	LB05F	8051	03
50	Zip & Zip 50 4 T Aria	02-	LB05E	8031	01
75	Vespa Junior	-	LB05F	8051	03
75	Vespa PK 75S	-	LB05F	8051	03
75	Vespa T3 Primavera	-	LB05F	8051	03
75	Vespa PK 75S	-	LB05F	8051	03
75	Vespa PK 75XL / Elestart	-	LB05F	8051	03
80	PK 80 S / PX 80 E	-	LB05F	8051	03
80	P 80 X / Sfera / TPH	-	LB05F	8051	03
100	Diesis	01-	LB05E	8031	01
100	Fly / Zip	06-	LB05E	8031	01
100	Free	02-	LB05E	8031	01
100	PK 100 S	82-	LB05F	8051	03
100	Zip	06-	LB05E	8031	01
125	Ape	85-	LB05F	8051	03
125	Beverly 125	02-	LB05E	8031	01
125	Carnaby 125	07-	LB05E	8031	01
125	Cosa / FL / FL EBC / MA AE	88-	LB05F	8051	03
125	ET 3	-	LB05F	8051	03
125	ET 4 Automatic	-	LB05E	8031	01
125	Fly 125	05-	LB05E	8031	01
125	Hexagon LX 4 tps 2V Air	-	LB05E	8031	01
125	Hexagon LX 125	94-	LB05F	8051	03
125	Hexagon LX 4T/4V H20 (liq.)	-	LB05E	8031	01
125	Liberty 4 tps	-	LB05E	8031	01
125	MP3	06-	LB05E	8031	01
125	MP3 125 i.e.	06-	L05EA	6667	-
125	P 125 ETS	83-85	LB05F	8051	03
125	PK	85-	LB05F	8051	03
125	PK XL 2 / XL Auto. / E / S	-	LB05F	8051	03
125	Primavera	76-83	LB05F	8051	03
125	PX 125 E Lusso	82-	LB05F	8051	03
125	Sfera 125 / RST 4 T	95-	LB05F	8051	03
125	Skipper 125 LX	93-	LB05F	8051	03
125	Skipper 125 4 tps	00-	LB05E	8031	01
125	SKR 125	93-	LB05F	8051	03
125	Super Hexagon GTX 4T	01-	LB05E	8031	01
125	Tourer	02-	LB05E	8031	01
125	TPH	95-	LB05F	8051	03
125	Vespa 125 FL2	90-	LB05F	8051	03
125	Vespa 125 CL, LS	-	LB05F	8051	03
125	Vespa 125 NK Primavera	-	LB05F	8051	03
125	Vespa ET4 125	96-	LB05E	8031	01
125	Vespa ET4 125	96-	VD05EM	8422	-
125	Vespa ET4	99-	LB05E	8031	01
125	Vespa ET4	99-	VD05EM	8422	-
125	Vespa Gandturismo	-04	LB05E	8031	01

CYL. MODÈLES



N° N°
STOCK BLISTER

PIAGGIO

125	Vespa GTS 125	07-	L05EA	6667	-
125	Vespa GTS Super 125 i.e.	10-	L05EA	6667	-
125	Vespa GTV 125	-	L05EA	6667	-
125	Vespa GT	03-	LB05E	8031	01
125	Vespa LX 125	05-	LB05E	8031	01
125	Vespa LX 125	05-	VD05EM	8422	-
125	Vespa LX 125 i.e.	09-	L05EA	6667	-
125	Vespa LXV 125	-	LB05E	8031	01
125	Vespa LXV 125	-	L05EA	6667	-
125	Vespa PX 125 Kat	-	LB05F	8051	03
125	Vespa PX125 MA AE	-	LB05F	8051	03
125	Vespa Spe. ET3 Primavera	-	LB05F	8051	03
125	Vespa Spe. ET4 Carbu.	-	LB05E	8031	01
125	Vespa S 125 i.e.	08-	L05EA	6667	-
125	Vespa T3Li / T3	-	LB05F	8051	03
125	Vespa T5, PK125	-	LB05F	8051	03
125	Vespa XL 125 Elestart	-	LB05F	8051	03
125	Vespa XL 125 Plurimat	-	LB05F	8051	03
125	Vespa 125 T5 Elestart	-	LB05F	8051	03
125	Vespa 125 T5 Sport	-	LB05F	8051	03
125	X7	07-	LB05E	8031	01
125	X7 EVO i.e.	07-	V05E	6665	-
125	X8	04-	LB05E	8031	01
125	X9 11kW	-	LB05E	8031	01
125	X EVO	06-	LB05E	8031	01
125	Zip 125	-	LB05E	8031	01
150	EX 150 (Hexagon)	94-	LB05F	8051	03
150	Hexagon 150	94-	LB05F	8051	03
150	Liberty	-	LB05E	8031	01
150	Liberty	02-	L05EA	6667	-
150	PX 150 E Lusso	82-	LB05F	8051	03
150	Skipper 150	93-	LB05F	8051	03
150	Skipper ST 4T	01-	LB05E	8031	01
150	SKR 150	98-	LB05F	8051	03
150	Vespa LX 150 i.e.	08-	L05EA	6667	-
150	Vespa PX 150 MA AE	86-	LB05F	8051	03
150	Vespa PX 150 Kat	-	LB05F	8051	03
150	Vespa S 150 i.e.	08-	L05EA	6667	-
150	Vespa 150 long 19,0 mm	-	LB05F	8051	03
150	Vespa 150 long 12,7 mm	-	LB05F	8051	03
150	Vespa 150 ET4	01-	LB05E	8031	01
160	Vespa 160 / GT	-	LB05F	8051	03
175	Vespa 175	-	LB05F	8051	03
180	Super Hexagon LXT 180	01-	LB05E	8031	01
180	Vespa SS	-	LB05F	8051	03
180	X9 4T	01-	LB05E	8031	01
190	Ape	-	LB05F	8051	03
200	Beverly 200 MA AE	01-	LB05E	8031	01
200	Camaby 200	07-	LB05E	8031	01
200	Cosa 200	88-91	LB05F	8051	03
200	Cosa FL 200	91-	LB05F	8051	03
200	Cosa 200 Aluzyl.12 PS	93-97	LB05F	8051	03
200	Liberty 200	04-	LB05E	8031	01
200	PX 200 E Lusso	84-	LB05F	8051	03
200	PX 200 Grand-Sport	84-	LB05F	8051	03
200	Vespa PX / Iris / DN / DS	86-	LB05F	8051	03
200	Vespa E / TX / Elestart	86-	LB05F	8051	03
200	X8	05-	V05E	6665	-
220	Ape	-	LB05F	8051	03
250	Beverly / Cruiser / Tourer	03-	LB05E	8031	01
250	Hexagon GT 250 4Temps	98-	VD05F-R	8376	-
250	MP3 250 / RST 250	06-	LB05E	8031	01
250	Vespa GTS 250	06-	LB05E	8031	01
250	Vespa GTS 250 i.e.	06-	L05EA	6667	-
250	X7 / X8 / X9 Evo	06-	LB05E	8031	01
278	Camaby 300 i.e.	09-	L05EA	6667	-
278	Vespa GTV300 M.napoleone	10-	L05EA	6667	-
278	Vespa GTS 300 Super	08-	L05EA	6667	-
500	X9 / X9 Evo ABS	05-	V05E	6665	-

CYL. MODÈLES



N° N°
STOCK BLISTER

POLARIS - Quad



250	Big Boss	89-93	LB05EZ	8744	-
250	Cyclone	88-89	LB05EZ	8744	-
250	Scrambler	89-93	LB05EZ	8744	-
250	Trail Blazer	90-	LB05EZ	8744	-
250	Trail Boss	85-99	LB05EZ	8744	-
283	Xplorer 300 / Xpress 300	94-99	LB05EZ	8744	-
334	Sportsman 335	99-	LB05EZ	8744	-
350	Big Boss	93-	LB05EZ	8744	-
350	Trail Boss	90-93	LB05EZ	8744	-
379	Big Boss 400L (6X6)	95-97	LB05EZ	8744	-
379	Scrambler 400 (4X4)	94-	LB05EZ	8744	-
379	Sport 400	98-	LB05EZ	8744	-
379	Sport ATV	95-97	LB05EZ	8744	-
379	Sportsman 4x4	94-97	LB05EZ	8744	-
379	Xplorer 400 / 400L 4x4	94-99	LB05EZ	8744	-
379	Xpress 400 L 2x4	96-97	LB05EZ	8744	-
400	Big Boss	95-97	LB05EZ	8744	-
400	Scrambler	94-99	LB05EZ	8744	-
400	Sport / Sportsman	95-99	LB05EZ	8744	-
400	Xplorer / Xpress	94-99	LB05EZ	8744	-
425	Magnum (2X4) / (4X4)	95-	LB05EZ	8744	-
425	Magnum (6X6)	96-97	LB05EZ	8744	-
498	Big Boss 500 (6X6)	98-	LB05EZ	8744	-
498	Magnum 500 / Ranger	99-	LB05EZ	8744	-
498	Scrambler 500	97-	LB05EZ	8744	-
498	Sportsman 500	96-04	LB05EZ	8744	-
498	Xplorer 500	97-	LB05EZ	8744	-
500	Big Boss (6x6)	98-	LB05EZ	8744	-
500	Magnum / Ranger	98-	LB05EZ	8744	-
500	Scrambler / Sportsman	96-98	LB05EZ	8744	-
500	Xplorer	96-98	LB05EZ	8744	-

PUCH



50	Lido	-	LB05F	8051	03
80	Cobra 12,9 - 19,0 mm	81-	LB05F	8051	03
125	Lido 125	-	LB05F	8051	03

RIEJU



50	RR 50 AM6 / RS 1	-	LB05F	8051	03
----	------------------	---	-------	------	----

SACHS



50	Speedfight 50 AC / LC / ADT	97-	LB05F	8051	03
125	RS 125 / ZX 125	97-	LB05F	8051	03

SIAM



50	Falkon 50	97-	LB05FP	8030	-
----	-----------	-----	--------	------	---

SPIGAOU





125		-	LD05F-R	8231	-
-----	--	---	---------	------	---

SUZUKI



50	A 50K / P / AH / AJ / AP	-	LB05F	8051	03
50	AE 50 L / AH 50	90-	LB05F	8051	03
50	AP 50 S / V / FS / T	95-	LB05F	8051	03
50	AY50 Katana	97-	LB05F	8051	03
50	CL 50 DO / CP 50	-	LB05F	8051	03

CYL.	MODÈLES			N°	
				STOCK	BLISTER
50	CP 50 H-J / L / M / N	-	LB05F	8051	03
50	CS 50 / CX 50 / CY 50	-	LB05F	8051	03
50	DM 50 / DR Big 50 / DV 50	-	LB05F	8051	03
50	FA / FR / FS / FZ	-	LB05F	8051	03
50	GT 50 / K 50 / OR 50	-	LB05F	8051	03
50	JR 50	93-95	LB10EH	8351	-
50	JR 50 K>N,P,R,S,T,V,W	89-	LB10EH	8351	-
50	LT 50 L	90-	LB05F	8051	03
50	Maxi 50 / NM 50 / OR 50	-	LB05F	8051	03
50	RB 50 GAG / H	87-	LD05F-R	8231	-
50	RG 50 / KE RM 50 / RV50	-	LB05F	8051	03
50	RMX 50 W / Suzy	97-	LB05F	8051	03
50	TR 50 / S Street Magic W	97-	LB05F	8051	03
50	TS 50 ER / ERA / ERAP	-	LB05F	8051	03
50	TS 50 XA / XK M / R	-	LB05F	8051	03
50	ZR 50 SA / SAP	-	LB05F	8051	03
50	ZR 50 SLA / SLAP	-	LB05F	8051	03
80	CP / CS / FR / GT / LT	-	LB05F	8051	03
80	DS 80	93-	LB05F	8051	03
80	FR 80	-	LB05F	8051	03
80	RG 80 Gamma H / J / M	-	LB05F	8051	03
80	RM 80 X / H / WF	88-	LB05F	8051	03
80	TS 80 ER Z / ERX	82-	LB05F	8051	03
80	TS 80 X G / H	86-	LB05F	8051	03
90	FM 90 / RV 90	-	LB05F	8051	03
100	A / AG 100 M	91-	LB05F	8051	03
100	AH 100 / F / GP, TS 100 X	-	LB05F	8051	03
100	FB 100 / D	95-	LD05F-R	8231	-
125	AN 125 S / T / V / W	95-	LD05F-R	8231	-
125	CS 125	95-	LD05F-R	8231	-
125	DR 125 E / S / SE / SJ	-	LD05F-R	8231	-
125	GN 125	83-90	LD05F-R	8231	-
125	GS 125 S	-	LD05F-R	8231	-
125	GZ 125 Marauder W	98-	LD05F-R	8231	-
125	GP / GT / K 125	-	LB05F	8051	03
125	RC 125RG 125 / B / BU / U	88-	LB05F	8051	03
125	RG 125 UC F / G / H / J / L	-	LB05F	8051	03
125	RG 125 FU N / P / R	92-	LB05F	8051	03
125	RM 125	87-97	LB05F	8051	03
125	TS 125 A / B / K / L / M	73-77	LB05F	8051	03
125	TS 125 ER / N / T / X	79-83	LB05F	8051	03
125	TS 125 R K / M / N / P / R	89-	LB05F	8051	03
125	TS 125 X G / H / J	86-	LB05F	8051	03
150	AN 150 T	96-	LD05F-R	8231	-
160	LT 160 E / F (ATV)	93-	LD05F-R	8231	-
185	GT 185 / TS 185 ER	-	LB05F	8051	03
200	DR 200 SZ	95-	LD05F-R	8231	-
200	GT 200	-	LB05F	8051	03
200	TS 200 R M	91-	LB05F	8051	03
230	LT 230 E / F / GE (ATV)	-	LD05F-R	8231	-
250	DR 250 S D / H	83-	XD05F-R	8768	-
250	DR 250 S / SZ / SZH	90-	XD05F-R	8768	-
250	GN 250 M / R / T / S	91-	LD05F-R	8231	-
250	GSX 250 L	-	SD05F-R	8238	-
250	LT 250 R H	87-	LB05F	8051	03
250	LTF 250 J	88-	LD05F-R	8231	-
250	RG 250 G / H	86-87	LB05F	8051	03
250	RGV 250 K / L / M / N / P	89-	LB05F	8051	03
250	RM 250	87-	LB05F	8051	03
250	RMX 250 K / L / M	-	LB10EH	8351	-
250	TS 250 G	86-	LB05F	8051	03
400	DR 400 S	80-83	LD05F-R	8231	-
400	GN 400 TD-X	-	LD05F-R	8231	-
400	GS 400 TX	-	VB05F	8032	-
400	GSF 400 Bandit M / N / P	91-	SD05F-R	8238	-
400	GSX 400 E (GS40X)	83-	VB05F	8032	-
400	GSX 400 FW	-	SD05F-R	8238	-
400	GSX 400 FX, LX	-	SD05F-R	8238	-
400	GSX 400 S, SE, EF, R	-	SD05F-R	8238	-
450	GS 450 E / ES / L / SF / TX	-	VB05F	8032	-
500	GS 500 E (GM51B)	93-00	XD05F-R (IN) VD05F-R (OUT)	8768 8376	-

CYL.	MODÈLES			N°	
				STOCK	BLISTER
550	GSX 550 ES D / H / L	83-	XB05F-R (IN) VB05F (OUT)	8592 8032	-
550	GSX 550 EF / EFEH / EUFH	-	SD05F-R	8238	-
550	GT 550	73-77	LB05F	8051	03
600	DR 600 S, SU	-	LD05F-R	8231	-
600	DR 600 SF-K, SUF-SUK	-	LD05F-R	8231	-
600	DR 600 R Djebel (I)	-	LD05F-R	8231	-
650	GR 650 D / XD / XF (GP51A)	-	LD05F-R	8231	-
650	Antiparasite droit	-	SB05FP	8386	-
750	GS 750 D / E / L	-	XB05F-R (IN) VB05F (OUT)	8592 8032	-
750	GSX 750 E, EF, ES, S	-	SD05F-R	8238	-
750	GSX 750 S Katana	-	SD05F-R	8238	-
750	GSX-R 750 (GR75A)	-	XD05F-R	8768	-
750	GSX-R 750 (GR77B)	88-	XD05F-R	8768	-
750	GSX-R 750 (GR7AB)	91-	XD05F-R	8768	-
750	GSX-R 750	92-	SD05FM-R	8673	-
750	VS 750 GL / H / JK	-	SD05F-R	8238	-
750	VS 750 GL / GLP / GLF	-	SD05F-R	8238	-
850	GS 850 G / GL	-	XB05F-R (IN) VB05F (OUT)	8592 8032	-
1000	GS 1000 D, E, H, S	-	XB05F-R (IN) VB05F (OUT)	8592 8032	-
1100	GS 1100 G G	86-	XB05F-R (IN) VB05F (OUT)	8592 8032	-
1100	GSX 1100 EFG / EG	86-	SD05F-R	8238	-
1100	GSX 1100 EZ / ESD / S / SZ	86-	SD05F-R	8238	-
1150	GSX 1150 E	-	SD05F-R	8238	-
1150	GSX 1150 EF	-	SD05F-R	8238	-
1150	GSX 1150 ES	-	SD05F-R	8238	-



SUZUKI - Quad

50	ALT 50	83-88	LB10EH	8351	-
50	LT 50	84-87	LB10EH	8351	-
50	LT 50	-	LB05F	8051	03
80	LT 80	98-00	LB05F	8051	03
125	ALT 125	83-86	LD05F-R	8231	-
125	LT 125	83-87	LD05F-R	8231	-
150	LT 150S	88-89	VD05F-R	8376	-
160	LT 160 E (coudé à 120°)	89-92	VD05F-R	8376	-
160	LT 160 E (coudé à 90°)	-92	LD05F-R	8231	-
160	LT 160 E	92-	LD05F-R	8231	-
160	LT F160	91-00	VD05F-R	8376	-
160	LT 160 F	93-	LD05F-R	8231	-
185	ALT 185	85-	LB05F	8051	03
185	LT 185	84-87	LB05F	8051	03
230	LT 230	85-93	VD05F-R	8376	-
230	LT F230G	87-	VD05F-R	8376	-
230	LT 230 E / F / GE125	-	LD05F-R	8231	-
250	LT F250	88-99	VD05F-R	8376	-
250	LT 250	88-93	VD05F-R	8376	-
250	LT 250	85-86	XD05F-R	8768	-
250	LT 250R	85-92	LB10EH	8351	-
250	LT 250S	89-90	VD05F-R	8376	-
250	LT F250	88-00	VD05F-R	8376	-
250	LT F250F	99-00	VD05F-R	8376	-
250	LT F4WD	87-98	VD05F-R	8376	-
250	LT F4WDX	91-98	VD05F-R	8376	-
300	LT 300	87-89	XD05F-R	8768	-
300	LT F300F	99-00	VD05F-R	8376	-
500	LT A500F	98-00	VD05F-R	8376	-
500	LT 500	87-90	LB10EH	8351	-



TM

Modèles 2 temps	-	SD05F-R	8238	-
Modèles 4 temps	-	LB05EMH-R	8160	-

CYL. MODÈLES

N° N°
STOCK BLISTER

TRIUMPH

865	Scrambler 900 inj.	06-	SD05F-R	8238	-
865	Thruxton 900 inj.	04-	SD05F-R	8238	-



URAL RETRO

750		-	LB05F	8051	03
-----	--	---	-------	------	----



VOR

400	MX / Enduro / SM	00-	SD05FM-R	8673	-
503	MX / Enduro / SM	99-	SD05FM-R	8673	-





YAMAHA



50	Tous modèles	-	LB05F	8051	03
60	Tous modèles	-	LB05F	8051	03
65	CW 65	94-	LB05F	8051	03
70	V 70	-	LB05F	8051	03
80	Active 80	-	LB05F	8051	03
80	CH / CV / DT / FS / GT	-	LB05F	8051	03
80	Evolis (4MU)	-	LB05F	8051	03
80	LB, MX, PW, RD, RX, T, TY	-	LB05F	8051	03
80	V / Y / YB / YE 80	-	LB05F	8051	03
80	YFM 80 T / YSR 80	87-	LD05F-R	8231	-
80	YZ 80 Tous modèles	-	LB05F	8051	03
80	Zest	-	LB05F	8051	03
90	V 90	-	LB05F	8051	03
90	YA 90 E / F	93-	LB05F	8051	03
100	AG 100 H	-	LB05F	8051	03
100	AG / DT / DX / MX	-	LB05F	8051	03
100	RT 100 G / H / YB / YZ	-	LB05F	8051	03
100	RS / RT / RX / RXS / RXZD	-	LB05F	8051	03
100	V 100 / E / S / SH	93-	LB05F	8051	03
100	YB 100 M / P, YZ 100 E / H	-	LB05F	8051	03
100	YFM 100 / YFM 100 T	89-91	LD05F-R	8231	-
110	V 110 E	93-	LB05F	8051	03
115	RX 115	93-	LB05F	8051	03
120	V 120 JR / ZR	94-	LB05F	8051	03
125	BL / DT / IT / MX	85-89	LB05F	8051	03
125	R / RD / RS / RX	85-89	LB05F	8051	03
125	SR 125	96-	LD05F-R	8231	-
125	SR 125 / SR 125 SE	-95	LD05F-R	8231	-
125	TA / TY / TZ / TZR	-	LB05F	8051	03
125	TDR 125	92-	LB05F	8051	03
125	XC 125 B, E, F, G, H, S, X	-	LD05F-R	8231	-
125	XC 125 SC, W, ZSC, ZS, ZW	-	LD05F-R	8231	-
125	XC 125 T Cygnus	96-	LD05F-R	8231	-
125	XC 125 TR Cygnus	96-	LD05F-R	8231	-
125	XC 125 TR Cygnus R	-	LD05F-R	8231	-
125	XT 125	-	LD05F-R	8231	-
125	XT 125 E / EC / F / FC	93-	LD05F-R	8231	-
125	XT 125 / J / K / KC / L	-	LD05F-R	8231	-
125	XV 125 (5AJ)	97-	LD05F-R	8231	-
125	XV 125 / XV 125 Virago	-	LD05F-R	8231	-
125	YB 125	-	LB05F	8051	03
125	YB 125 / YS 125 / YT 125	-	LB05F	8051	03
125	YFA 1 Breeze / YS / YT	-	LD05F-R	8231	-
125	YS 125	-	LB05F	8051	03
125	YZ 125 A / U / W / N / S	-	LB05F	8051	03
125	YZ 125 B / C / E / E1 / F	-	LB05F	8051	03
125	YZ 125 G / G1 / H / LC / X	-	LB05F	8051	03
150	FZ 150 / FZR 150	94-	LD05F-R	8231	-
150	RX 150	93-	LB05F	8051	03
150	SR 150	93-	LD05F-R	8231	-
150	XC 150 Fly one	93-	LD05F-R	8231	-
165	DT 165 R	91-	LB05F	8051	03

CYL. MODÈLES

N° N°
STOCK BLISTER

175	Tous modèles	-	LB05F	8051	03
180	RT 180 E	93-	LB05F	8051	03
180	XC 180 (32H)	83-84	LD05F-R	8231	-
185	SH 185 H	-	LD05F-R	8231	-
195	RS 195	-	LB05F	8051	03
200	AG 200 E / F	93-	LD05F-R	8231	-
200	BW 200	-	LD05F-R	8231	-
200	DT 200 LC / RE / RF / R	93-	LB05F	8051	03
200	DT R / IT / RD / RS	-	LB05F	8051	03
200	NR 200	-	LB05F	8051	03
200	RD 12,7-19mm C / DX, D / DX	-	LB05F	8051	03
200	RS	-	LB05F	8051	03
200	TW	87-	LD05F-R	8231	-
200	TW E / EC / F	93-	LD05F-R	8231	-
200	WR B / R / RD	-	LB05F	8051	03
200	WR RE / RG / RH	-	LB05F	8051	03
200	YFM DX	-	LD05F-R	8231	-
200	YFM N (Moto-4)	-	LD05F-R	8231	-
200	YFS Blaster / E / F	-	LB05F	8051	03
200	YTM EK / EL / ERN	-	LD05F-R	8231	-
200	YTM K / L / N	-	LD05F-R	8231	-
225	TT	-	LD05F-R	8231	-
225	XT E / EC / F / FC	93-	LD05F-R	8231	-
225	YFM	-	LD05F-R	8231	-
225	YFM S (Moto-4)	-	LD05F-R	8231	-
230	YFU 1 / YFU 1 TW	90-	LD05F-R	8231	-
240	TDR	-	LB05F	8051	03
240	XV	-	LD05F-R	8231	-
250	DT E / H / MX	-	LB05F	8051	03
250	IT H / I / J / K / N	-	LB05F	8051	03
250	MX	-	LB05F	8051	03
250	R1-Z	93-	CR2	8048	-
250	RD LC	-	LB05F	8051	03
250	RDD / H / J	-	LB05F	8051	03
250	SE	-	LB05F	8051	03
250	SR H / F / SE / TH	-	LB05F	8051	03
250	TRD, TDR	-	LB05F	8051	03
250	TT R / RF	94-	LB05F	8051	03
250	TY N / R / S	-	LB05F	8051	03
250	TY Z	94-	LB05F	8051	03
250	TZ E / F / H	83-	LB05F	8051	03
250	TZR R / RS / RSP	-	LB05F	8051	03
250	TZR A / T	-	LB05F	8051	03
250	WR	97-	LB05F	8051	03
250	WR Z / ZB / ZF / ZH	-	LB05F	8051	03
250	XS C / H / RH / SE / SH	-	LB05F	8051	03
250	XS PK / SK / R	-	LD05F-R	8231	-
250	XT A / B / H / J / K / KC	-	LB05F	8051	03
250	XT H (DOHC)	-	SD05F-R	8238	-
250	XV F / S / SG (Virago)	95-	LD05F-R	8231	-
250	XV	-	XD05F-R	8768	-
250	XV W / WC	-	LD05F-R	8231	-
250	YFB Timberwolf E / F / FW	-	LD05F-R	8231	-
250	YFM	90-	LD05F-R	8231	-
250	YP D Majesty DX	98-	LD05F-R	8231	-
250	YP Majesty	-	LD05F-R	8231	-
250	YZ (1LU/2HH)	82-	LB05F	8051	03
250	YZ (2VM / 3JE / 3SP / 3XK)	88-91	LB05F	8051	03
250	YZ (5X5/24Y/39X/56A)	82-	LB05F	8051	03
250	YZ (4DA/4EW)	92-	LB05F	8051	03
250	YZ (4MX)	95-	LB05F	8051	03
250	YZ F	94-	LB05F	8051	03
350	BW	-	LD05F-R	8231	-
350	TZ B / H	-	LB05F	8051	03
350	XT	-	LD05F-R	8231	-
360	DT (RT2)	73-75	LB05F	8051	03
360	MX / YZ	-	LB05F	8051	03
400	DT E / H	-	LB05F	8051	03
400	FZR	-	SD05F-R	8238	-
400	IT	-	LB05F	8051	03
400	MX	-	LB05F	8051	03
400	MX / RD	-	LB05F	8051	03
400	RD E	-	LB05F	8051	03

CYL.	MODÈLES			N° STOCK	N° BLISTER
400	SR	-	LB05F ou CR2	8051 8048	03
400	TT C	-	LB05F	8051	03
400	XJ	-	XD05F-R	8768	-
400	XT	84-	LD05F-R	8231	-
400	XVSE	-	XB05F-R	8592	-
400	YZ	-	LB05F	8051	03
400	YZ C	-	LB05F	8051	03
400	YZ E	-	LB05F	8051	03
400	YZF	-	SD05F-R	8238	-
425	IT	-	LB05E	8031	01
465	IT H / J	-	LB05E	8031	01
465	YZ H	-	LB05E	8031	01
490	IT (29W)	83-85	LB05F	8051	03
490	YZ	-	LB05F	8051	03
500	IT	-	LB05F	8051	03
500	RD LC / SR / XT	-	LB05F ou CR2	8051 8048	03
500	XJ	-	XD05F-R	8768	-
500	XT (1E6 / 1V6)	76-89	LB05F	8051	03
500	XT 500 E	-92	LB05F	8051	03
500	XT 500 C / H	-	LB05F	8051	03
500	XVSE (26R)	83-87	XB05F-R	8592	-
550	XT (5Y3)	82-83	LD05F-R	8231	-
550	XZ	82-84	LD05F-R	8231	-
600	SRX	86-89	SD05F-R	8238	-
600	XT (2KF / 2NF)	87-90	XD05F-R	8768	-
600	XT (43F)	84-87	XD05F-R	8768	-
600	XT E (4PT / 4SK)	95-	LD05F-R	8231	-
600	XT E / EF / EFC	94-	LD05F-R	8231	-
600	XT E(h) (3TB)	97-	LD05F-R	8231	-
600	XT E(n) (3UW)	97-	LD05F-R	8231	-
600	XT E / K (3TB / 3UW)	90-94	LD05F-R	8231	-
650	XJ / H / LH / SH / T	-	XB05F-R	8592	-
650	XS E / H / II / S / SE / SH	-	XB05F-R	8592	-
750	FZ (1FN)	85-86	SD05F-R	8238	-
750	FZ (3KT)	91-	SD05F-R	8238	-
750	FZ Génésis (2KK)	87-90	SD05F-R	8238	-
750	TZ / D	-	LB05F	8051	03
750	XJ	-	LB05F ou CR2	8051 8048	03
750	XS C / D / E / S / SE / T	-	XB05F-R	8592	-
750	XTS SE	-	XB05F-R	8592	-
750	XV	-	XB05F-R	8592	-
750	YZF R / RF / RFC (4HN)	93-	XD05F-R	8768	-
850	XS / H / LH / SH	-	XB05F-R	8592	-
900	XJ	-	XB05F-R	8592	-
1000	XV	-	XB05F-R	8592	-
1100	FJ	84-85	SD05F-R	8238	-
1100	XS / E / H / LH / RH / S / SH	-	XB05F-R	8592	-
1100	XV / SC	-	XB05F-R	8592	-

CYL.	MODÈLES			N° STOCK	N° BLISTER
1200	FJ / AE / AEC / E / F	-	SD05F-R	8238	-
1200	XVZ 12T (47G)	84-87	XD05F-R	8768	-



YAMAHA - Quad

60	YF	84-86	LB05F	8051	03
60	YF 60 (1HN)	87-88	LB05F	8051	03
60	YT	84-85	LB05F	8051	03
80	YFM	85-97	LD05F-R	8231	-
80	YFM E / F	93-	LD05F-R	8231	-
80	YFM W	02-	LD05F-R	8231	-
100	YFM	87-91	LD05F-R	8231	-
125	YFA-1	89-97	XD05F-R	8768	-
125	YFA 1 Breeze	89-04	LD05F-R	8231	-
125	YFA-1F	94-	LD05F-R	8231	-
125	YT (connexion monobloc)	80-85	LB05E	8031	01
125	YT (connexion filetée)	-	LB05F	8051	03
125	YT CH	-	LB05F	8051	03
125	YT H	-	LB05F	8051	03
175	YT	82-83	LB05F	8051	03
200	YFM	85-89	XD05F-R	8768	-
200	YFM 52H / 2HT / 59V	-	LD05F-R	8231	-
200	YFS 200 Blaster	90-04	LB05F	8051	03
200	YFS 200 E / F	93-	LB05F	8051	03
200	YFS	88-04	LB05E	8031	01
200	YTM	83-86	XD05F-R	8768	-
200	YTZ	85-86	LB05E	8031	01
225	TT	-	LD05F-R	8231	-
225	YFM	86-88	XD05F-R	8768	-
225	YFM 59V / 2HT	92-	LD05F-R	8231	-
225	YTM	83-86	XD05F-R	8768	-
250	YFB	92-97	XD05F-R	8768	-
250	YFB E / F / FW / FWF	93-	LD05F-R	8231	-
250	YFM	89-91	XD05F-R	8768	-
250	YFM Timberwolf	-	LD05F-R	8231	-
250	YFM 3GH	90-	LD05F-R	8231	-
350	YFB	96-97	LD05F-R	8231	-
350	YFM - F	87-97	LD05F-R	8231	-
350	YFM - X	87-97	XD05F-R	8768	-
350	YFU-1	89-	XD05F-R	8768	-
350	YFZ	87-97	LB05E	8031	01
400	YFM	93-97	LD05F-R	8231	-



SONDES LAMBDA



CARACTÉRISTIQUES TECHNIQUES

RÉFÉRENCES CONSTRUCTEURS - CARACTÉRISTIQUES

MARQUE	RÉF. CONSTRUCTEUR	NGK - NTK	N°STOCK	NOMBRE DE FILS	N° CONNECTEUR	LONG. DES FILS (mm)
APRILIA	A2 C 53 025 886	OAZ591-SZ1	1767	4	31	590
	11781 247 406	OAZ447-E28	0427	4	68	340
BMW	11787 671 756	OZA522-BM1	0053	4	69	922
	11787 671 757	OZA522-BM2	0054	4	69	554
	11787 672 785	OZA630-BM2	0073	4	99	521
	11787 674 452	OZA630-BM1	0072	4	99	231
	11787 685 320	OZA630-BM3	0074	4	68	341
	CA.0083 476 / 55 21 11 11A	OZA591-BB3	0066	4	40	880
DUCATI	466-031	OZA591-BA1	6496	4	31	320
	552 1149 1A	OZA591-BA2	90520	4	31	420
	552 1219 1A	OZA591-BA1	6496	4	31	320
HONDA	36531-GEZ-6410-M1	OZA577-H13	6475	4	96	225
	36351-KRJ-901	OZA577-H6	0065	4	96	280
	36351-KTF-641	OZA577-H15	0064	4	96	210
	36531-KTW-9010-M1	ZSJ0002-HG002	6538	1	127	285
	36531-MAT-G220-M1	AZD0101-HG004	6543	4	96	640
	36531-MBG-0010	OZA333-H29	6459	4	96	510
	36531-MBG-6310-M1	OZA333-H16	6456	4	96	510
	36531-MNT-C410-M1	OZA656-H2	6492	4	96	880
	36531-MBT-D210-M1	OZA577-H7	6471	4	96	840
	36531-MCA-0231	AZD0101-HG001	6539	4	96	700
	36531-MCA-R310	OZA577-H27	1346	4	137	780
	36531-MCA-R310-M1	OZA577-H27	1346	4	137	780
	36531-MCS-D910-M1	OZA656-H5	6494	4	96	530
	36531-MCS-G010-M1	OZA577-H4	6463	4	96	530
	36531-MCW-D010-M1	OZA333-H30	6460	4	96	340
	36531-MEF-D010-M1	OZA577-H22	6483	4	96	440
	36351-MEL-6110-M1	OZA577-H12	6473	4	80	970
	36531-MEL-D210-M1	OZA577-H21	6479	4	80	865
	36531-MFAA-D011-M1	OZA577-H17	0007	4	80	990
	36531-MFE-6410-M1	OZA577-H19	6476	4	96	225
	36531-MFF-D011-M1	OZA656-H1	6491	4	80	305
	36531-MFG-D010-M1	OZA656-H3	6493	4	80	500
	36531-MFJ-D011-M1	OZA577-H24	6484	4	80	675
	36531-MFL-6410-M1	AZD0102-HG009	6576	4	105	930
	36531-MFPA-D010-M1	AZD0102-HG003	7664	4	80	930
	36532-MCA-0231	AZD0101-HG002	6540	4	96	750
	36532-MCA-R310	OZA577-H28	1347	4	105	840
	36532-MCA-R310-M1	OZA577-H28	1347	4	105	840
	36352-MCS-D910-M1	OZA656-H6	6495	4	96	530
	36532-MCS-G010-M1	OZA577-H5	6469	4	96	530
	36532-MCV-7720-M1	AZD0101-HG003	6541	4	96	450
	36532-MCW-D010-M1	OZA333-H31	6462	4	96	300
	36532-MFE-6410-M1	OZA577-H20	6477	4	96	405
	36532-MFPA-D010-M1	AZD0102-HG004	7665	4	80	590

RÉFÉRENCES CONSTRUCTEURS - CARACTÉRISTIQUES

MARQUE	RÉF. CONSTRUCTEUR	NGK - NTK	N°STOCK	NOMBRE DE FILS	N° CONNECTEUR	LONG. DES FILS (mm)
HUSQVARNA	E 252 201	OAZ591-WB1	010	4	97	410
HYOSUNG	E 252 201	OAZ591-WB1	010	4	97	410
	21176-0015	AZD0102-KJ004	6574	4	34	760
	21176-0043	AZD0101-KJ001	6551	4	80	345
	21176-0073	AZD0101-KJ002	6552	4	34	235
	21176-0077	AZD0101-KJ004	6556	4	34	345
KAWASAKI	21176-0081	AZD0101-KJ005	6558	4	80	500
	21176-0086	AZD0101-KJ006	6559	4	34	235
	21176-0089	AZD0101-KJ008	6561	4	34	275
	21176-0097D	AZD0102-KJ001	6567	4	34	235
	21176-0114	AZD0102-KJ003	6568	4	34	660
	1614-902-000	AZD0101-VB002	7673	4	80	500
KTM	1614-883-0000	OZA591-VB2	0009	4	97	500
	610 041 090 000	OZA591-VB2	009	4	97	500
	1614-897-000	AZD0101-BA001	7667	4	80	310
KYMCO	3160-0361 / 39450-LEA6-800	OZA591-YB1	0011	4	31	310
	CA.001 9265 / 32 727 010	OZA341-BB1	0036	4	40	310
MOTO GUZZI	CA.0083 477 A	OZA591-BB2	1710	4	40	310
MOTO MORINI	CA.0019 265	OZA591-BB3	0066	4	40	880
MV AGUSTA	CA.0083 476.A	OZA591-BB3	006	4	40	880
	A2C 53 025 886	OZA591-SZ1	1767	4	31	590
PEUGEOT	46 603 00A	OZA591+SZ1	1767	4	31	590
	18213-01H00	OZA448-J4	003	4	80	690
	18213-06G00	OZA448-J2	6414	4	124	480
	18213-10F00	AZD0101-SU001	6545	4	128	610
	18213-10G00	OZA523-J1	1333	4	80	720
	18213-15H00	AZD0101-SU004	7668	4	128	235
	18213-16G00	OZA448-J3	6415	4	80	630
SUZUKI	18213-18H00	AZD0101-SU005	7671	4	128	710
	18213-22H00	OZA582-J4	6447	2	126	203
	18213-24FA0	OZA448-J1	6413	4	80	420
	18213-27GOO	OZA591-J2	6454	4	80	365
	18213-41F00	AZD0101-SU002	6547	4	128	460
	18213-48G00	OZA448-J5	0004	4	80	370
	18213-48G10	OZA582-J3	6446	2	126	370
	2201 247	OZA591-UB2	0008	4	97	535
	2201 347	OZA591-UB1	0067	4	97	640
	002-H528-15000	AZD0101-VB004	7690	4	80	250
TRIUMPH	1614-007-0000	AZD0101-VB003	7689	4	80	500
	1614-897-0000	AZD0101-VB001	7672	4	80	500
	1614-902-000	AZD0101-VB002	7673	4	80	500



SCHÉMAS DES CONNECTEURS

N°	SCHÉMAS	RÉFÉRENCES	N° STOCK
31		OZA591-BA1	6496
		OZA591-BA2	90520
		OZA591-SZ1	1767
		OZA591-YB1	001
34		AZD0101-KJ002	6552
		AZD0101-KJ004	6556
		AZD0101-KJ006	6559
		AZD0101-KJ008	6561
		AZD0102-KJ001	6567
		AZD0102-KJ003	6568
		AZD0102-KJ004	6574
40		OZA341-BB1	0036
		OZA591-BB2	1710
		OZA591-BB3	0066
68		OZA457-EE12	97070
		OZA630-BM3	0074
69		OZA522-BM1	0053
		OZA522-BM2	0054
80		AZD0101-BA001	7667
		AZD0101-KJ001	6551
		AZD0101-KJ005	6558
		AZD0101-VB001	7672
		AZD0101-VB002	7673
		AZD0101-VB003	7689
		AZD0101-VB004	7690
		AZD0102-HG003	7664
		AZD0102-HG004	7665
		OZA448-J1	6413
		OZA448-J3	6415
		OZA448-J4	0003
		OZA448-J5	0004
		OZA523-J1	1333
		OZA577-H12	6473
		OZA577-H17	0007
		OZA577-H21	6479
OZA577-H24	6484		
OZA591-J2	6454		
OZA656-H1	6491		
OZA656-H3	6493		

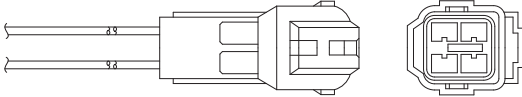
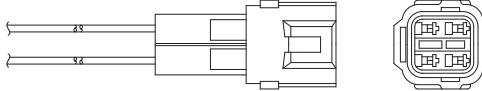
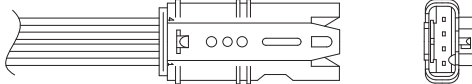
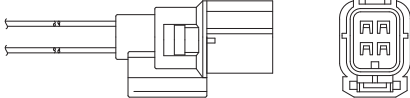
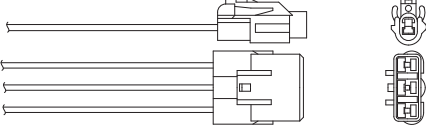
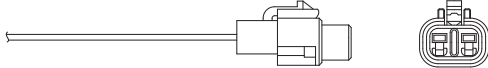
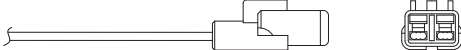
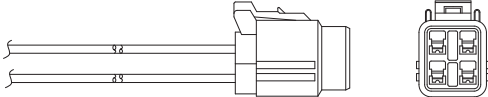
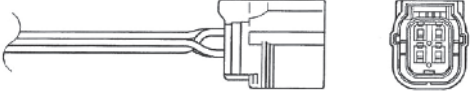
N°	SCHÉMAS	RÉFÉRENCES	N° STOCK
96		AZD0101-HG001	6539
		AZD0101-HG002	6540
		AZD0101-HG003	6541
		AZD0101-HG004	6543
		OZA333-H16	6456
		OZA333-H29	6459
		OZA333-H30	6460
		OZA333-H31	6462
		OZA577-H13	6475
		OZA577-H15	0064
		OZA577-H19	6476
		OZA577-H20	6477
		OZA577-H22	6483
		OZA577-H4	6463
		OZA577-H5	6469
		OZA577-H6	0065
OZA577-H7	6471		
97		OZA591-UB1	0067
		OZA591-UB2	0008
		OZA591-VB2	0009
		OZA591-WB1	0010
99		OZA630-BM1	0072
		OZA630-BM2	0073
105		AZD0102-HG009	6576
		OZA577-H28	1347
124		OZA448-J2	6414
126		OZA582-J3	6446
		OZA582-J4	6447
127		ZSJ0002-HG002	6538
128		AZD0101-SU001	6545
		AZD0101-SU002	6547
		AZD0101-SU004	7668
		AZD0101-SU005	7671
137		OZA577-H27	1346



SONDES LAMBDA



MODÈLES	MOTEUR	CYL.	CV DIN				N° STOCK	¹ Nb FILS	² *N° CONNECT.	³ LONG.
---------	--------	------	-----------	--	--	--	-------------	----------------------------	---------------------------------	-----------------------

APRILIA



RSV 1000 R	Rotax V2	998	139	04.04-	OZA591-SZ1		1767	4	31	590
RSV 1000 R Factory	Rotax V2	998	139	10.03-	OZA591-SZ1		1767	4	31	590
Tuono 1000 R	Rotax V2	998	139	03.06-	OZA591-SZ1		1767	4	31	590
Tuono 1000 R Factory	Rotax V2	998	139	03.06-	OZA591-SZ1		1767	4	31	590

BMW

F 650 CS		652	34	11.01-12.03	OZA457-EE12		97070	4	68	340
F 650 GS / Dakar		652	50	09.99-12.03	OZA457-EE12		97070	4	68	340
F 650 CS	K14/02	652	34-50	01.04-12.05	OZA630-BM3		0074	4	68	341
F 650 GS	R13Mü	652	34-50	12.03-12.07	OZA630-BM3		0074	4	68	341
G 650 Xchallenge	K15	650	53	03.07-08.11	OZA630-BM1		0072	4	99	231
G 650 Xmoto / Xcountry	K15	650	53	03.07-08.11	OZA630-BM1		0072	4	99	231
F 650 GS	K72	798	34-71	10.07-	OZA630-BM2		0073	4	99	521
F 800 S	K71	798	34-84	12.05-	OZA630-BM2		0073	4	99	521
F 800 GS	K72	798	86	10.07-	OZA630-BM2		0073	4	99	521
F 800 ST	K71	798	34-84	09.06-	OZA630-BM2		0073	4	99	521
F 800 R	K73	798	34-84	12.06-02.09	OZA630-BM2		0073	4	99	521
F 800 R	K73/02	798	34-87	03.09-	OZA630-BM2		0073	4	99	521
R 850 R	R28	848	34-71	07.02-08.05	OZA522-BM1		0053	4	69	922
R 850 RT	R22	848	71	03.01-12.04	OZA522-BM1		0053	4	69	922
R 1100 S	259S	1085	98	01.03-12.03	OZA522-BM1		0053	4	69	922
R 1150 GS / Adventure	R21	1130	86	11.01-09.06	OZA522-BM1		0053	4	69	922
R 1150 R	R28	1130	86	10.02-08.05	OZA522-BM1		0053	4	69	922
R 1150 RS	R22	1130	95	05.01-09.04	OZA522-BM1		0053	4	69	922
R 1150 RT	R22	1130	95	03.01-12.04	OZA522-BM1		0053	4	69	922
K 1200 GT	K41GT	1171	98-130	11.02-08.05	OZA522-BM1		0053	4	69	922
K 1200 GT	K44	1157	152	12.05-10.08	OZA630-BM2		0073	4	99	521
K 1200 LT	K589	1171	115	01.04-07.08	OZA522-BM2		0054	4	69	554
K 1200 RS	K41	1171	98-130	01.01-12.04	OZA522-BM1		0053	4	69	922
K 1200 R	K43	1157	163	03.05-09.08	OZA630-BM2		0073	4	99	521
K 1200 S	K40	1157	167	06.04-09.08	OZA630-BM2		0073	4	99	521
R 1200 C	259C	1170	61	06.03-12.04	OZA522-BM1		0053	4	69	922
R 1200 CL	K30	1170	61	02.02-12.04	OZA522-BM1		0053	4	69	922
R 1200 GS	K25	1170	98	11.03-01.08	OZA630-BM1		0072	4	99	231
R 1200 GS / Adventure	K25Mü	1170	105	10.07-	OZA630-BM1		0072	4	99	231
R 1200 R	K27	1170	110	12.06-09.10	OZA630-BM1		0072	4	99	231
R 1200 RT	K26	1170	110	10.04-07.09	OZA630-BM1		0072	4	99	231
R 1200 S	K29	1170	110	10.05-12.07	OZA630-BM1		0072	4	99	231
R 1200 ST	K28	1170	110	12.04-07.08	OZA630-BM1		0072	4	99	231
HP2	K25HP	1170	105	12.05-12.06	OZA630-BM1		0072	4	99	231
HP2 Megamoto	K25HPMeg	1170	113	10.07-10.08	OZA630-BM1		0072	4	99	231
HP2 Sport	K29HP	1170	130	11.07-04.10	OZA630-BM1		0072	4	99	231
K 1300 GT	K44TÜ	1293	160	10.08-	OZA630-BM2		0073	4	99	521
K 1300 R / S	K43Mü	1293	173	10.08-	OZA630-BM2		0073	4	99	521

DUCATI

Monster 695		695	73	06.04-07.08	OZA591-BB3		0066	4	40	880
Monster 696		696	80	08.08-	OZA591-BA2	2 sondes	90520	4	31	420
Hypermotard 796		803	82	01.10-	OZA591-BA1	2 sondes	6496	4	31	320
Monster 796		803	87	08.09-	OZA591-BA2	2 sondes	90520	4	31	420
Monster S2R		803	77	04.06-07.08	OZA591-BB3		0066	4	40	880
848 / S		849	135	09.07-	OZA591-BB3		0066	4	40	880
GT 1000		992	92	01.06-	OZA591-BB3		0066	4	40	880
Monster S2R 1000		992	95	01.06-07.08	OZA591-BB3		0066	4	40	880
Monster S4RS		992	130	06.04-07.08	OZA591-BB3		0066	4	40	880
Paul Smart 1000		992	92	01.06-07.08	OZA591-BB3		0066	4	40	880

MODÈLES	MOTEUR	CYL.	CV DIN				N° STOCK	¹ Nb FILS	² *N° CONNECT.	³ LONG.
ST3 / S		992	107	01.04-12.07	OZA591-BB3		0066	4	40	880
Sport 1000		992	92	01.06-	OZA591-BB3		0066	4	40	880
Desmosedici RR		989	200	07.07-12.08	OZA591-BB3		0066	4	40	880
Hypermotard / S		1078	95	08.07-12.09	OZA591-BB3		0066	4	40	880
Hypermotard 1100 Evo / SP		1078	95	01.10-	OZA591-BA1	2 sondes	6496	4	31	320
Monster 1100 / S		1078	95	01.09-12.10	OZA591-BB3		0066	4	40	880
Monster 1100 Evo		1078	99	01.11-	OZA591-BA2	2 sondes	90520	4	31	420
Multistrada 1100 / S		1078	95	06.06-12.09	OZA591-BB3		0066	4	40	880
1098 / S		1098	162	11.06-12.08	OZA591-BB3		0066	4	40	880
1098 R		1098	179	01.08-	OZA591-BB3		0066	4	40	880
Streetfighter / S		1099	158	01.09-	OZA591-BB3		0066	4	40	880
1198 / S		1198	170	01.08-	OZA591-BB3		0066	4	40	880

HONDA

Zoomer 50		50	4	01.05-	OZA577-H13		6475	4	96	225
Pantheon 125i		125	14	01.05-	OZA577-H6		0065	4	96	280
PS 125i		125	14	01.06-	OZA577-H15		0064	4	96	210
SH 125i		125	14	01.05-	OZA577-H15		0064	4	96	210
S-Wing 125		125	14	01.06-	OZA577-H15		0064	4	96	210
PS 150i		150	15	01.06-	OZA577-H15		0064	4	96	210
Pantheon 150i		150	16	01.05-	OZA577-H6		0065	4	96	280
SH 150i		150	15	01.05-	OZA577-H15		0064	4	96	210
S-Wing 150 / ABS		150	15	01.06-	OZA577-H15		0064	4	96	210
SH 300 / ABS		279	38	04.07-	ZSJ0002-HG002		6538	1	127	285
Silver Wing 600		582	50	02.07-	OZA577-H22		6483	4	96	440
Hornet 600		599	102	02.07-	OZA656-H3		6493	4	80	500
CBR 600 RR		599	120	01.07-	OZA577-H24		6484	4	80	675
XL 680 Transalp		680	60	07.08-	OZA656-H1		6491	4	80	305
VT 750		745	46	01.07-	OZA577-H19	Sonde 1	6476	4	96	225
VT 750		745	46	01.07-	OZA577-H20	Sonde 2	6477	4	96	405
VT 750 Shadow		745	46	01.07-	OZA577-H19	Sonde 1	6476	4	96	225
VT 750 Shadow		745	46	01.07-	OZA577-H20	Sonde 2	6477	4	96	405
VT 750 Shadow Spirit		745	46	01.07-	OZA577-H19	Sonde 1	6476	4	96	225
VT 750 Shadow Spirit		745	46	01.07-	OZA577-H20	Sonde 2	6477	4	96	405
VFR 800		782	109	01.99-12.99	OZA333-H16		6456	4	96	510
VFR 800		782	109	01.00-12.00	OZA333-H29		6459	4	96	510
VFR 800		782	109	01.01-	OZA333-H30	Sonde 1	6460	4	96	340
VFR 800		782	109	01.01-	OZA333-H31	Sonde 2	6462	4	96	300
XL 1000 Varadeiro		996	94	01.03-12.06	OZA577-H7		6471	4	96	840
XL 1000 Varadeiro		996	94	01.07-	OZA656-H2		6492	4	96	880
CBF 1000 / ABS		998	98	01.06-	OZA577-H17		0007	4	80	990
CBR 1000 RR Fireblade		998	171	02.04-12.05	OZA577-H12		6473	4	80	970
CBR 1000 RR Fireblade		998	171	01.06-12.07	OZA577-H21		6479	4	80	865
CBR 1000 RR Fireblade		1000	178	01.08-	AZD0102-HG009		6576	4	105	930
CBR 1100 XX Super Blackbird		1137	152	01.03-12.07	AZD0101-HG004		6543	4	96	640
Pan European		1261	126	01.06-08.07	OZA577-H4	Sonde 1	6463	4	96	530
Pan European		1261	126	01.06-08.07	OZA577-H5	Sonde 2	6469	4	96	530
Pan European		1261	126	09.07-	OZA656-H5	Sonde 1	6494	4	96	530
Pan European		1261	126	09.07-	OZA656-H6	Sonde 2	6495	4	96	530
CB 1300		1284	115	03.08-	AZD0102-HG003	Sonde 1	7664	4	80	930
CB 1300		1284	115	03.08-	AZD0102-HG004	Sonde 2	7665	4	80	590
CB 1300 S		1284	115	03.08-	AZD0102-HG003	Sonde 1	7664	4	80	930
CB 1300 S		1284	115	03.08-	AZD0102-HG004	Sonde 2	7665	4	80	590
VTX 1800		1795	96	01.03-12.05	AZD0101-HG003		6541	4	96	450
GL 1800 Gold Wing		1832	118	01.04-12.06	OZA577-H27	Sonde 1	1346	4	137	780
GL 1800 Gold Wing		1832	118	01.04-12.06	OZA577-H28	Sonde 2	1347	4	105	840
GL 1800 Gold Wing		1832	118	01.07-	AZD0101-HG001	Sonde 1	6539	4	96	700
GL 1800 Gold Wing		1832	118	01.07-	AZD0101-HG002	Sonde 2	6540	4	96	750

HUSQVARNA

TE 450		449	29	09.07-	OZA591-WB1		0010	4	97	410
SM 450 R		449	19	09.07-	OZA591-WB1		0010	4	97	410
SM 510 R		501	19	09.07-	OZA591-WB1		0010	4	97	410
SM 610		576	53	10.06-	OZA591-WB1		0010	4	97	410

*Voir schémas des connecteurs pages 128 et 129

MODÈLES	MOTEUR	CYL.	CV DIN				N° STOCK	¹ Nb FILS	² *N° CONNECT.	³ LONG.
HYOSUNG										
GT 650i		647	34	01.07-	OZA591-WB1		0010	4	97	410
GT 650i		647	82	01.07-	OZA591-WB1		0010	4	97	410
GV 650i		647	33	01.07-	OZA591-WB1		0010	4	97	410
GV 650i		647	80	01.07-	OZA591-WB1		0010	4	97	410



KAWASAKI										
ZX-6R Ninja		599	34	01.07-	AZD0101-KJ002	Sonde 1	6552	4	34	235
ZX-6R Ninja		599	34	01.07-	AZD0101-KJ006	Sonde 2	6559	4	34	235
ZX-6R Ninja		599	98	01.07-	AZD0101-KJ002	Sonde 1	6552	4	34	235
ZX-6R Ninja		599	98	01.07-	AZD0101-KJ006	Sonde 2	6559	4	34	235
ZX-6R Ninja		599	125	01.07-	AZD0101-KJ002	Sonde 1	6552	4	34	235
ZX-6R Ninja		599	125	01.07-	AZD0101-KJ006	Sonde 2	6559	4	34	235
ZX-10R		998	174	11.05-05.06	AZD0101-KJ001		6551	4	80	345
ZX-10R		998	175	06.06-12.07	AZD0101-KJ004	Sonde 1	6556	4	34	345
ZX-10R		998	175	06.06-12.07	AZD0101-KJ005	Sonde 2	6558	4	80	500
ZX-10R		998	175	01.08-	AZD0102-KJ003	Sonde 1	6568	4	34	660
ZX-10R		998	175	01.08-	AZD0102-KJ004	Sonde 2	6574	4	34	760
ZZR 1400		1352	98	01.07-12.07	AZD0101-KJ004	Sonde 1	6556	4	34	345
ZZR 1400		1352	98	01.07-12.07	AZD0101-KJ008	Sonde 2	6561	4	34	275
ZZR 1400		1352	190	01.07-12.07	AZD0101-KJ004	Sonde 1	6556	4	34	345
ZZR 1400		1352	190	01.07-12.07	AZD0101-KJ008	Sonde 2	6561	4	34	275
ZZR 1400		1352	193	01.08-	AZD0102-KJ001		6567	4	34	235

KTM										
690 Enduro		654	61	03.08-	AZD0101-VB002		7673	4	80	500
690 Supermoto		654	64	03.07-	AZD0101-VB002		7673	4	80	500
690 Supermoto R		654	63	03.08-	AZD0101-VB002		7673	4	80	500
690 SMC		654	61	03.08-	AZD0101-VB002		7673	4	80	500
690 Duke		654	65	03.08-	AZD0101-VB002		7673	4	80	500
990 Adventure / S		999	34-98	01.06-	OZA591-VB2		0009	4	97	500
990 Superduke / R		999	120	01.06-	OZA591-VB2		0009	4	97	500
990 Supermoto		999	115	03.08-	OZA591-VB2		0009	4	97	500

KYMCO										
People S 200i		163	11	01.07-	AZD0101-BA001		7667	4	80	500
People S 250i		251	20	01.07-	AZD0101-BA001		7667	4	80	500
Yager GT 200i		176	15	06.06-	OZA591-YB1		0011	4	31	590
Venox 250 AFI		249	29	06.06-	OZA591-YB1		0011	4	31	590
Xciting 250i		251	22	06.06-	OZA591-YB1		0011	4	31	590

MV AGUSTA										
F4 Brutale 910		910	136	10.06-12.08	OZA591-BB2		1710	4	40	310
Brutale 989 R		989	141	01.09-	OZA591-BB2		1710	4	40	310
F4 1000R		998	174	10.06-12.08	OZA591-BB2		1710	4	40	310
Brutale 1078 RR		1078	147	01.09-	OZA591-BB2		1710	4	40	310
F4 1000CC		1078	192	07.07-12.08	OZA591-BB2		1710	4	40	310
F4 1078 RR		1078	190	01.09-	OZA591-BB2		1710	4	40	310

MOTO GUZZI										
Breva V 750 i.e.		744	34-49	01.03-12.05	OZA341-BB1		0036	4	40	310
Breva V 750 i.e.		744	49	01.06-	OZA591-BB2		1710	4	40	310
Nevada V 750 i.e.		744	49	01.06-	OZA591-BB2		1710	4	40	310
Breva V 850 i.e.		877	72	01.06-	OZA591-BB2		1710	4	40	310
Griso V 850 i.e.		877	76	01.06-	OZA591-BB2		1710	4	40	310
Norge V 850 i.e.		877	72	01.06-	OZA591-BB2		1710	4	40	310
Breva V 1100		1064	84	03.04-12.05	OZA341-BB1		0036	4	40	310
Breva V 1100 i.e.		1064	86	01.06-	OZA591-BB2		1710	4	40	310
California EV / Touring		1064	75	03.04-12.05	OZA341-BB1		0036	4	40	310
California Classic		1064	75	01.06-12.05	OZA341-BB1		0036	4	40	310
California Classic		1064	73	01.06-	OZA591-BB2		1710	4	40	310
California Touring		1064	75	01.06-12.05	OZA341-BB1		0036	4	40	310
California Vintage		1064	75	01.06-12.05	OZA341-BB1		0036	4	40	310
California Vintage		1064	73	01.06-	OZA591-BB2		1710	4	40	310
Griso V 1100 i.e.		1064	88	01.06-	OZA591-BB2		1710	4	40	310
V11 Cafè Sport		1064	91	03.04-12.04	OZA341-BB1		0036	4	40	310
V11 Coppa Italia		1064	91	03.04-12.05	OZA341-BB1		0036	4	40	310
V11 Le Mans / Nero		1064	91	03.04-12.05	OZA341-BB1		0036	4	40	310
V11 Le Mans Rosso Corsa		1064	91	03.04-12.05	OZA341-BB1		0036	4	40	310
V11 Scura R / Sport Ballabio		1064	91	01.05-12.05	OZA341-BB1		0036	4	40	310
Norge V 1200 i.e.		1151	90	01.06-	OZA591-BB2		1710	4	40	310

MODÈLES	MOTEUR	CYL.	CV DIN				N° STOCK	①	②	③
								Nb FILS	*N° CONNECT.	LONG.
Sport V 1200 i.e.		1151	95	01.06-	OZA591-BB2		1710	4	40	310
Stelvio 1200 4V		1151	110	01.09-	OZA591-BB2		1710	4	40	310

MOTO MORINI

Corsaro 1200		1187	140	01.05-	OZA591-BB2		1710	4	40	310
9 1/2		1187	117	01.05-	OZA591-BB2		1710	4	40	310

PEUGEOT

Geopolis 125		125	15	03.06-	OZA591-SZ1		1767	4	31	590
Satelis 125		125	15	03.06-	OZA591-SZ1		1767	4	31	590
Satelis 125 K15 Compresseur		125	15	03.06-	OZA591-SZ1		1767	4	31	590
Satelis 125 K20 Compresseur		125	20	03.06-	OZA591-SZ1		1767	4	31	590

ROYAL ENFIELD

Bullet 500 Classic		499	27	01.09-	AZD0101-VB001		7672	4	80	500
Bullet 500 Electra		499	27	01.09-	AZD0101-VB001		7672	4	80	500

SUZUKI

RV 125 VanVan		125	12	01.07-	AZD0101-SU002		6547	4	128	460
GSX-R 600		599	124	03.06-12.07	OZA448-J4		0003	4	80	690
GSX-R 600		599	124	01.08-	AZD0101-SU005		7671	4	128	710
AN 650 Burgman		638	54	01.03-12.03	OZA523-J1		1333	4	80	720
DL 650 V-Strom		645	34-67	03.06-	OZA591-J2		6454	4	80	365
SV 650 / S		645	34	01.07-	AZD0101-SU005		7671	4	128	710
SV 650 / S		645	72	01.07-	AZD0101-SU005		7671	4	128	710
GSX-R 750		750	149	03.06-12.07	OZA448-J4		0003	4	80	690
GSX-R 750		750	149	01.08-	AZD0101-SU005		7671	4	128	710
VL 800 Intruder		805	53	05.04-	AZD0101-SU001		6545	4	128	610
DL 1000 V-Strom		996	98	05.02-12.06	OZA448-J2		6414	4	124	480
TL 1000		996	125	05.07-12.00	OZA448-J3		6415	4	80	630
GSX-R 1000		999	185	01.07-	AZD0101-SU004		7668	4	128	235
Bandit 1200 / S		1157	98	11.06-12.07	AZD0101-SU005		7671	4	128	710
GSX-R 1300 Hayabusa		1299	175	05.02-12.06	OZA448-J1		6413	4	80	420
GSX-R 1300 Hayabusa		1299	175	05.07-	AZD0101-SU004		7668	4	128	235
VL 1500 Intruder		1462	67	01.06-	AZD0101-SU002		6547	4	128	460
M 1800 R		1783	125	04.06-12.07	OZA448-J5		0004	4	80	370
VZR 1800 Intruder		1783	125	01.08-	OZA582-J3		6446	2	126	370
VZR 1800 Intruder		1783	125	01.08-	OZA582-J4		6447	2	126	203

TRIUMPH

Daytona 600		599	34-98	01.03-12.05	OZA591-UB1		0067	4	97	640
Daytona 600		599	111	01.03-12.05	OZA591-UB1		0067	4	97	640
Speed Four		599	34-98	01.02-	OZA591-UB1		0067	4	97	640
Daytona 675		675	34-98	01.07-	AZD0101-VB003		7689	4	80	500
Daytona 675		675	124	01.07-	AZD0101-VB003		7689	4	80	500
Street Triple 675		675	34-106	01.08-	AZD0101-VB003		7689	4	80	500
Thunderbird Sport		855	91	01.03-12.04	OZA591-UB1		0067	4	97	640
America		865	34-56	01.07-	AZD0101-VB003		7689	4	80	500
Bonneville		865	34-68	01.07-	AZD0101-VB003		7689	4	80	500
Scrambler		865	34-57	01.07-	AZD0101-VB003		7689	4	80	500
Thrupton		865	34-69	01.07-	AZD0101-VB003		7689	4	80	500
Daytona 955i		955	98-147	01.01-	OZA591-UB1		0067	4	97	640
Speed Triple		955	98-147	01.01-12.05	OZA591-UB1		0067	4	97	640
Sprint RS		955	98-147	01.01-12.04	OZA591-UB1		0067	4	97	640
Sprint ST		955	98-147	01.01-12.04	OZA591-UB1		0067	4	97	640
Tiger		955	98-106	01.03-12.06	OZA591-UB1		0067	4	97	640
Tiger		1050	98-114	01.07-	AZD0101-VB002		7673	4	80	500
Sprint ST		1050	98-125	01.05-12.07	OZA591-UB1		0067	4	97	640
Sprint ST		1050	98-126	01.08-	AZD0101-VB002		7673	4	80	500
Speed Triple		1050	98-129	01.06-12.07	OZA591-UB1		0067	4	97	640
Speed Triple		1050	98-132	01.08-	AZD0101-VB002		7673	4	80	500
Thunderbird		1599	80	01.09-	AZD0101-VB004		7690	4	80	250
Rocket III		2294	141	01.04-12.04	OZA591-UB2		0008	4	97	535
Rocket III / Classic		2294	98	01.05-12.06	OZA591-UB2		0008	4	97	535
Rocket III		2294	98-140	01.07-	AZD0101-VB002		7673	4	80	500
Rocket III / Classic		2294	140	01.05-12.06	OZA591-UB2		0008	4	97	535



STOCK-TYPE BOUGIES D'ALLUMAGE

Top Vente	NGK N° Stock	N° BLISTER N° Stock	PRINCIPALES APPLICATIONS	NGK IX N° Stock
1	CR7HSA 4549	07 6016	HONDA CRF 100 F, KAWASAKI KLX 140, KYMCO Agility, People, PEUGEOT V-Clic 50, Tweet 125/150, Vivacity 125, YAMAHA 125 BW'S, TTR 125, YAMAHA-Quad YFM 80/125	CR7HIX 7544
2	BR9ES 5722	02 5061	APRILIA Mojito Custom 50, Scarabeo 50, Sportcity 50, RX/RS/SR/SX 50, DERBI Boulevard / Sonar 50 HUSQVARNA CR/SM 50, MBK X-Limit 50, PEUGEOT 50 XR6 / XR7, YAMAHA 125 DT	BR9EIX 3981
3	CR8E 1275	04 5671	HONDA CBR 125 RWB, HYOSUNG 650 Comet, KAWASAKI 250 Ninja, KYMCO 125 Quannon SUZUKI 125 Adress, Burgman, Van Van, 650 Bandit, YAMAHA YZ 450	CR8EIX 4218
4	CR9EK 4548	/	KAWASAKI Z 750 R, TRIUMPH Tiger 800 YAMAHA WR 250, FZ6 Fazer, FZ1 Fazer	CR9EIX 3521
5	BR8HS 4322	01 4967	MBK Booster 50, Nitro 50, Stunt 50, PEUGEOT Speedfight 50, Trekker 50 YAMAHA CS 50, CW 50, YM 50 Breeze	BR8HIX 7001
6	DPR8EA-9 4929	08 6570	BENELLI 250, HONDA 750 Shadow, HONDA-Quad 250 Fourtrax, YAMAHA YP 250 R, XV 1900 YAMAHA-Quad YFM 660 Grizzly	DPR8EIX-9 2202
7	CR9E 6263	06 5995	BENELLI TNT 899, GAS GAS ECF 250, KAWASAKI ZX-6R Ninja, SUZUKI GSF 650 Bandit, GSX 1300 YAMAHA XJR 400 R, XJ 600, FZ 800 Redline	CR9EIX 3521
8	BR7HS 4122	03 5417	PEUGEOT Ludix 50, Speedfight 3 50, Vivacity 50 PIAGGIO, YAMAHA	BR7HIX 7067
9	CR7E 4578	12 7513	APRILIA 650 ie Pegaso, ARCTIC CAT Quad, KYMCO DOWNTOWN 125/200/300 i, People GT 200/300 i PEUGEOT LXR 125/200, SUZUKI GSF 1250 Bandit, YAMAHA	CR7EIX 7385
10	BR8ES 5422	05 1876	APRILIA RX/SX 125, DERBI 50 Senda DRD, GILERA SC 125, PEUGEOT 100 Speedfight 2 POLARIS-Motoneige 340, YAMAHA DT 125	BR8EIX 5044
11	CR8EH-9 5666	/	DAELIM 125 Freewing, HYOSUNG GT 125 HONDA SH 125, XL 125 Varadero, CRF 150, CBF 250, FJS 400 Silverwing, CB 600 F Hornet, CBF 1000	CR8EHIX-9 3797
12	CR9EH-9 7502	/	HONDA CB 600 Hornet, CBF 600, VFR 750/800	CR9EHIX-9 6216
13	CR9EIA-9 6289	/	KAWASAKI 650 ER6, Z 1000 SX, ZX-10R Ninja, GTR / ZZR 1400, SUZUKI GSX-R 600/750, GSX 1300 R Hayabusa, TRIUMPH 675 Daytona, YAMAHA 1700 V-Max, YZF 1000 R1	/
14	CR8EB 7784	/	APRILIA Atlantic 125, Leonardo 125, RXV/SVX 4.5 & 5.5, BMW C1, CAGIVA 500, DERBI 125 GILERA 125, HUSQVARNA, KAWASAKI KX250, PEUGEOT Satelis/Geo 125, PIAGGIO	CR8EIX 4218
15	B9ES 2611	02 5061	BETA REV 50/80, CAGIVA 125, CAN-AM 370/400 Qualifer, DERBI 50 Senda, GAS GAS, GILERA 50 HUSQVARNA MX 400, PIAGGIO 50/125/150, SUZUKI, YAMAHA	BR9EIX 3981
16	DR8EA 7162	11 6847	APRILIA Leonardo 300 ST, BETA 200 Urban, DERBI 125 Cross City, KYMCO 125 YAMAHA 125 TW, 250 X-Max, 250 YP, YAMAHA Quad YFM 350 Grizzly, YFM 450	DR8EIX 6681
17	BR9HS 4522	/	MBK 50 Stunt, YAMAHA 50 Slider	BR9HIX 5687
18	B7HS 5110	03 5417	MBK 51, PEUGEOT 50 Fox, 50 SPX, PIAGGIO 50 Vespa/Vespino, 125 Vespa, SUZUKI, YAMAHA	BR7HIX 7067
19	BR9EG 3230	/	CAGIVA Raptor 125, GAS GAS EC 125, SM 125, HONDA CR 125/250 R HUSQVARNA CR/WR 125, KTM EXC 250, YAMAHA YZ 125	/
20	DPR7EA-9 5129	13 5262	ARCTIC CAT Quad 250/ 300 DVX & Utility, DUCATI SS750, HARLEY-DAVIDSON 883 Sportster HONDA Quad TRX 350/450, KYMCO 125/250, SUZUKI, YAMAHA	DPR7EIX-9 7803
21	DCPR8E 4339	/	BIMOTA DB-5/6, BMW F 650/700/800 GS, F 800 R/GT/S/ST, CAN-AM Quad, DUCATI HARLEY-DAVIDSON, KTM, KTM Quad, SKI-DOO	DCPR8EIX 6546
22	B8HS 5510	01 4967	DERBI 50, KTM SX/SRX 50, PEUGEOT SV 50/80, PIAGGIO 50 Vespa ROYAL ENFIELD 500 Bullet, SUZUKI, YAMAHA RD 125/250/350	BR8HIX 7001
23	B8ES 2411	05 1876	APRILIA Extrema 50, BENELLI, BETA, CAGIVA, DERBI 50 GPR, HONDA NS 50R, MBK 51 Magnum, MOTO GUZZI, PIAGGIO, SUZUKI, TRIUMPH 750, YAMAHA	BR8EIX 5044
24	CR9EB 6955	/	APRILIA Scarabeo, RSV4, BENELLI, DERBI, DUCATI, GILERA Runner, HUSQVARNA TC/TE 250 MV AGUSTA, PEUGEOT 125 Atlantis, Satelis, PIAGGIO	CR9EIX 3521
25	CR7EKB 4455	/	APRILIA 400 / 500 Atlantic, Scarabeo, 850 Mana, 850 SRV, MALAGUTI 500 Spidermax PEUGEOT Geopolis, Satelis, PIAGGIO 400 MP3, 500 X9	/
26	JR9B 3188	/	SUZUKI GSF 1200 Bandit	/
27	CR6HSA 2983	/	HONDA CB 250 R, KAWASAKI KLX 110, YAMAHA XC 125, YBR 125	CR6HIX 7274
28	B6HS 4510	09 6676	MBK 51, MOTOBECANE, PEUGEOT 101, 102, 103, PIAGGIO 50 Vespa, YAMAHA 50 Chappy	BR6HIX 3419
29	CR8EK 3478	/	KTM 950 Super Duke, SHERCO 250 & 300, SUZUKI 200 Burgman, 1000 SV, TRIUMPH 1200 Tiger	CR8EIX 4218
30	BR10ES 4832	/	APRILIA Mojito Custom 50, DERBI GP1 50, SKI-DOO, SUZUKI RM 85	BR10EIX 6801



MOTOCULTURE



GAMME BLISTERS MOTOCULTURE



// 12 références ► Gamme compacte

// Couverture : 70% du parc de la motoculture de plaisance

// Tondeuses poussées, tractées, auto-portées, débroussailluses, groupes électrogènes et autres outillages autonomes thermiques

N° Blister Réf.	N° Stock	APPLICATIONS	MARQUES
01 BMR6A	5478	Tondeuses Tronçonneuses Débroussailluses Groupes	CUB CADET, ECHO, FLYMO, HONDA, HUSQVARNA, JOHN DEERE, KAWASAKI, KOHLER, MITSUBISHI, ROBIN, SHINDAIWA, SOLO, STIHL, TORO, WOLF
02 BPMR7A	5959	Tondeuses Tronçonneuses Débroussailluses Groupes	ECHO, DOLMAR, HOMELITE, HUSQVARNA, JOHN DEERE, JONSERED, KAWASAKI, OLEO-MAC, PARTNER, ROBIN, RYOBI, SHINDAIWA, SOLO, STIHL
03 BPR6ES	6854	Tondeuses Groupes Engins Manutention	HONDA, HUSQVARNA, JOHN DEERE, KAWASAKI, MITSUBISHI, SOLO, SUZUKI, TORO, TOYOTA, YAMAHA
04 BPR6ES	7678	Tondeuses Groupes	DOLMAR, EFCO, GENERAC, HONDA, HUSQVARNA, KOHLER, SABO, SUZUKI, WOLF
05 BR4-LM	4358	Tondeuses Débroussailluses Groupes	AGRIA, FLYMO, HUSQVARNA, JOHN DEERE, MITSUBISHI, TECUMSEH, TORO, WOLF
06 BR2-LM	4740	Tondeuses Débroussailluses Groupes Engins Manutention	BRIGGS & STRATTON, FLYMO, GENERAC, HOFFCO, HUSQVARNA, JOHN DEERE, PARTNER, SNAPPER, SOLO, TECUMESH, VIKING, WOLF, YANMAR
07 BKR5E	4803	Tondeuses Tronçonneuses Groupes	BRIGGS & STRATTON, CUB CADET, ECHO, GENERAC, HUSQVARNA, KOHLER, POULAN, SABRE, SNAPPER, SOLO, TORO
08 BPMR6A	5063	Tondeuses Tronçonneuses Débroussailluses Groupes	CUB CADET, ECHO, FLYMO, JOHN DEERE, JONSERED, HONDA, HUSQVARNA, OLEO-MAC, PARTNER, SHINDAIWA, SOLO, STIHL, TANAKA, TECUMSEH, TORO, YAMAHA
09 BR6S	6048	Tondeuses Tronçonneuses Débroussailluses Groupes Engins manutention	BRIGGS & STRATTON, CLARK, FLYMO, HOMELITE, ISEKI, JOHN DEERE, KAWASAKI, KOHLER, MASSEY-FERGUSON, McCULLOCH, STIHL, TECUMSEH, ZENOAH
10 BMR7A	6793	Tondeuses Tronçonneuses Débroussailluses Groupes	DOLMAR, FUJI-ROBIN, HOFFCO, HOMELITE, HUSQVARNA, JOHN DEERE, KAWASAKI, LOMBARD, PARTNER, REMINGTON, STIHL, SOLO, WARDS, ZENOAH
11 BMR6F	7683	Tronçonneuses Débroussailluses Groupes	DOLMAR, HOFFCO, HOMELITE, HUSQVARNA, McCULLOCH, PARTNER, RYOBI, SKIL, SOLO
12 CMR6H	4794	Débroussailluses	SHINDAIWA, STIHL

GAMME BLISTERS ANTIPARASITES

// 4 références

// Antiparasitage optimum

// Étanche et robuste

N° Blister	NGK	N° Stock	MARQUES
01	LB05E	6721	BRIGGS & STRATTON, ECHO, HONDA, HUSQVARNA, KAWASAKI, KOHLER, MASSEY FERGUSON, MITSUBISHI, TORO, YAMAHA, YANMAR
02	LB10F	8961	
03	LB05F	7981	
04	LB10E	9334	





MOTOCULTURE

SOMMAIRE



BOUGIES D'ALLUMAGE

- 138 à 210** Applications bougies d'allumage
- 211** Stock-type bougies d'allumage



BOUGIES DE PRÉCHAUFFAGE

- 214 à 219** Applications bougies de préchauffage
- 220** Stock-type bougies de préchauffage



BOUGIES D'ALLUMAGE

Modèle		N°		
		STOCK BOÎTE	BLISTER	STOCK BLISTER

ACE - Tondeuses				
Mot. B&S 3 / 3.5 / 4 / 5 / 8 / 10 / 12 / 18 hp	0,70	BR2-LM	5798	06 4740

ACME - Générateurs				
A 180 B / 220 B / 230 B	0,60	BP5HS	4111	- -
A 349 / 360	0,60	B-4H	4110	- -
ACT 280 OHC / 340 OHC	0,60	BKR5E	7938	07 4803
AL 480 WB / 550 WB / ALN 290 WB / 330 WB	0,60	BP5HS	4111	- -
AT 220 OHV / 330 OHV / VT 88 OHV / 94 OHV	0,60	BP5HS	4111	- -

ACME - Tondeuses				
Mot. Clinton & Autres modèles	0,70	BR2-LM	5798	06 4740

ACR EASE - Tondeuses				
Wing - Mot. B&S 8 / 12 hp	0,70	BR2-LM	5798	06 4740
Wing - Mot. B&S 17 hp	0,80	BR7ES	5122	- -
Wing - Mot. Kohler OHV 12.5 / 14 / 15 / 20 hp	0,80	BKR5E	7938	07 4803
Wing (223000->) - Mot. Tec.OHV 12.5 / 13 hp	0,80	BR7ES	5122	- -

AGCO ALLIS - Tondeuses				
409 - Mot. B&S 8.5 hp	0,80	B2-LM	1147	06 4740
411G - Mot. B&S 10.5 hp	0,70	BR2-LM	5798	06 4740
412 - Mot. Tecumseh OVH125 12.5 hp	0,80	BR6ES	4922	- -
412 / 512 - Mot. B&S 12.5 hp	0,70	BR2-LM	5798	06 4740
413H - Mot. Kohler CV12.5S 12.5 hp	1,10	BKR5ES-11	2382	- -
414H / 1614 / ZT - Mot. Kohler CV14S 14 hp	1,10	BKR5ES-11	2382	- -
515H - Mot. B&S OHV 15 hp	0,70	BKR5ES	2460	07 4803
516H / 1606 - Mot. Kohler Command 16 hp	0,70	BKR5ES	2460	07 4803
918 / 918H Mot. Kohler TH18S 18 hp	1,10	BKR5ES-11	2382	- -
918H - Mot. Kohler 18 hp	0,70	BKR5ES	2460	07 4803
4918 / 918H - Mot. Kohler TH18S 18 hp	1,00	BKR5ES-11	2382	- -
1316H / 1616H - Mot. B&S 16 hp	0,70	BKR5ES	2460	07 4803
1614H - Mot. B&S 14 hp, 1615 - Mot. B&S 15 hp	0,70	BKR5ES	2460	07 4803
1615H, ZT - Mot. Kohler 16 hp	0,70	BKR5ES	2460	07 4803
1616 / 1618 / 1716 - Mot. B&S 16 hp	0,70	BKR5ES	2460	07 4803
1717 - Mot. Kawa. FD501V 17hp (>98)	0,60	BMR6A	7421	01 5478
1717 - Mot. Kawa. FD501V 17hp (99->)	0,80	BPR4ES	7222	- -
1718H / 1918H - Mot. B&S 18 hp	0,70	BKR5ES	2460	07 4803
1720H - Mot. B&S Vanguard 20 hp	0,70	BKR5ES	2460	07 4803
1820H - Mot. Kohler Command 20 hp	0,70	BKR5ES	2460	07 4803
1823H - Mot. Kohler Command 23 hp	0,70	BKR5ES	2460	07 4803
1920H - Mot. Kohler 20 hp	0,70	BKR5ES	2460	07 4803
2020H - Mot. Kawasaki FD620D 20 hp	1,00	BMR2A-10	4452	- -
2025H - Mot. Kohler 25 hp	0,70	BKR5ES	2460	07 4803
2027H - Mot. Kohler Command Pro 27 hp	0,70	BKR5ES	2460	07 4803
2027LC - Mot. Kawa. OHV (Ref. Liquide) 27hp	0,80	BPR2ES	2264	- -

AGGRESSOR - Débroussailleuses				
Echo	0,70	BMR6A	7421	01 5478

AGRIA - Débroussailleuses				
300 - Mot. Rotax	0,50	AB-6	2910	- -
3400 - MAG 4 tps / Rotax 2 tps	0,80	BR6HS	3922	- -
5100 - Mot. Kawasaki	0,50	BMR6A	7421	01 5478

Modèle		N°		
		STOCK BOÎTE	BLISTER	STOCK BLISTER

5200 / 5300 - B&S	0,50	BR2-LM	5798	06 4740
5400 Rotax, 5500 - Mot. Rotax 4 tps	0,50	AB-6	2910	- -
5500 - Mot. Rotax 2 tps	0,80	BR6HS	3922	- -
IT 25 / 35 / 45 / 48 - Mot. Kawasaki	0,70	BM7A	6521	10 6793

AGRIA - Outils Divers				
100 R	0,70	BPR6ES	7822	04 7678
400 E Mot. B&S PB190	0,70	BKR5ES	2460	07 4803
400 E Mot. B&S 5hp, 400 K	0,70	BR2-LM	5798	06 4740
400 P	0,70	BPR6ES	7822	04 7678
500	0,70	CMR6A	1223	- -
900, 900 S, 1000, 3100, 3500	0,70	BPR6ES	7822	04 7678
1400 140-1	0,80	BR6HIX	3419	- -
1600 Compact / Premium (Essence)	0,70	BPR6ES	7822	04 7678
2500 (Essence)	0,70	BKR5ES	2460	07 4803
3400	0,60	BR6ES	4922	- -
3600 / Comfort / Compact / Premium	0,60	BR6HS	3922	- -
3900 (Essence)	0,70	BR6HS	3922	- -
5500 Comfort	0,60	BR6ES	4922	- -
5500 Compact, 5500 Premium Mot. Robin EH25D	0,70	BR6HS	3922	- -
5500 Premium Mot. Robin EH34D	0,60	BR6ES	4922	- -
6600 (Essence)	0,70	BKR5ES	2460	07 4803
7100 Basic / Comfort / Compact / Premium	0,70	BPR6ES	7822	04 7678
7500 TH 50 / TH 80	0,80	BPR6ES	7822	04 7678
7500 TH 120	0,80	ZGR5A	5839	- -

AGRIA - Tondeuses				
0300 / 1400	0,50	B6HS-5	6154	- -
300	0,50	B6HS-5	6154	- -
400 Quickly	0,60	B4-LM	3410	05 4358
1700 - Mot. JLO, 1700 / 2300 / 2400 - Mot. Hirth	0,50	AB-6	2910	- -
1700 / 2300 / 2400 - Mot. NSU	0,50	B-4H	4110	- -
2100 Ø14mm	0,50	B-4H	4110	- -
2100 Ø18mm	0,60	AB-6	2910	- -
2300 / 2400 - Mot. JLO (-> 04.1977)	0,50	AB-7	3010	- -
2400 - Mot. JLO (05.1977 ->), 3300 JLO	0,50	B6HS	4510	- -
3300 Max / 4700 / 9300	0,50	B-4H	4110	- -
4500 65 / 71 cm	0,70	BPR5ES	7422	03 6854
4500 80 / 85 cm	0,70	BKR5ES	2460	07 4803
5100	0,70	BPR6ES	7822	04 7678
5200R - Mot. Aspera 3.5 hp	0,70	BR4-LM	4133	05 4358
5200R - Mot. F&S 3.5 hp	0,70	BR6HS	3922	- -
5200R - Mot. Hirth 3.5 hp	0,60	AB-6	2910	- -
5300 441 - Mot. Honda GX160K1QPU	0,70	BPR6ES	7822	04 7678
5300 531 - Mot. Honda GX200QH4	0,70	BPR6ES	7822	04 7678
5300 611 - Mot. Robin EX21	0,60	BR6HS	3922	- -
5400 Mot. Robin EH17D / EH25D	0,60	BR6HS	3922	- -
5900 / 7900	0,70	BP6HS	4511	- -
8000 53 / 58 / 64 cm, 8200 V / V4	0,70	BPR6ES	7822	04 7678
8200 V6R	0,60	BR6HS	3922	- -
9300	0,70	B-4H	4110	- -
9300 Pilot	0,50	B5HS	4210	- -
Baby 2100 Ø14mm	0,50	B-4H	4110	- -
Baby 2100 Ø18mm	0,60	AB-6	2910	- -
ILO Ø14 mm (05.1977 ->)	0,50	B6HS	4510	- -
ILO Ø18 mm (-> 04.1977)	0,50	AB-7	3010	- -
Mot. B&S	0,50	B4-LM	3410	05 4358

Modèle	mm	N° STOCK BOÎTE	N° BLISTER STOCK	N° BLISTER	
Mot. F&S	0,50	B7HS	5110	-	-
Mot. Lombardini / MAG / NSU	0,50	B-4H	4110	-	-
Mot. Renault	0,70	BP6HS	4511	-	-
Record	0,60	AB-6	2910	-	-
SW 519 / 521 / 621 - Mot. Iseki / Kawasaki	0,80	BPR5ES	7422	03	6854

AGRICAT - Tondeuses

Tous modèles	0,60	AB-6	2910	-	-
--------------	------	-------------	------	---	---

AGRI-FAB - Tondeuses

Mot. B&S 8 / 10 / 11 / 12 hp	0,70	BR2-LM	5798	06	4740
Mot. B&S 14.5 hp	0,80	BKR5E	7938	07	4803

AGROS - Outils Divers

Agros	0,70	B5HS	4210	-	-
-------	------	-------------	------	---	---

AG-TRAC - Tondeuses

Mot. B&S	0,70	BR2-LM	5798	06	4740
----------	------	---------------	------	----	------

AGTRONIC - Générateurs

Mot. B&S	0,60	BM6A	5921	01	5478
----------	------	-------------	------	----	------

AGWAY - Tronçonneuses

754	0,80	BR6S	3522	09	6048
PL-4 / 5 / 6	0,70	BM7A	6521	10	6793

AIRCAP - Tondeuses

Mot. B&S, Mot. Tecumseh	0,70	BR2-LM	5798	06	4740
-------------------------	------	---------------	------	----	------

ALDENS - Tondeuses

Tous modèles	0,70	BR2-LM	5798	06	4740
--------------	------	---------------	------	----	------

AL-KO - Débroussailleuses

250	0,60	BPM6F	5950	-	-
18 / 24 / 33 / 40, BC 330 T / 400 T - Mot. Kawasaki	0,60	BM6A	5921	01	5478
BC 300, HS 4300 / 5300, LT 250 - Homelite	0,60	BPMR6F	1270	-	-

AL-KO - Outils Divers

750 B Mot. Tecumseh	0,50	BR2-LM	5798	06	4740
---------------------	------	---------------	------	----	------

AL-KO - Tronçonneuses

KB 3501 / 4001 / 4501 / 5000	0,50	BPMR7A	4626	02	5959
------------------------------	------	---------------	------	----	------

AL-KO - Tondeuses

Mot. Aspera	0,50	B4-LM	3410	05	4358
Mot. B&S 4 tps	0,50	BR4-LM	4133	05	4358
Mot. B&S AVS 1&2 Cyl. 12.5 / 20 hp	0,70	BKR5ES	2460	07	4803
Mot. B&S OHV 10.5 / 13.5 hp	0,70	BR2-LM	5798	06	4740
Mot. B&S OHV 12.5 / 17 / 20 hp	0,70	BKR5ES	2460	07	4803
Mot. Honda 4 tps	0,70	BPR5ES	7422	03	6854
Mot. Technomotor	0,60	BR2-LM	5798	06	4740
Mot. Tecumseh 4 tps	0,60	BR6S	3522	09	6048
Mot. Tecumseh OHV 11 / 13 hp	0,70	BR7ES	5122	-	-
Powerline 4700 BR-H Mot. Honda GCV135	0,70	BPR6ES	7822	04	7678
Powerline 5200 BRV-H Mot. Honda GCV160	0,70	BPR5ES	7422	03	6854
Silver 470 BR-H Premium Mot. Honda GCV135	0,70	BPR6ES	7822	04	7678
Silver 520 BRV-H Prem. Mot. Honda GCV160	0,70	BPR5ES	7422	03	6854

Modèle	mm	N° STOCK BOÎTE	N° BLISTER STOCK	N° BLISTER

ALLEN - Débroussailleuses

20SDS, BT22, Mini 17 / 22	0,70	BMR6A	7421	01	5478
BT19, Pro 43	0,70	BPMR6A	6726	08	5063
Deluxe 22, Domestic 22, Reciprocator	0,70	BMR6A	7421	01	5478
Pro 37	0,50	B6HS	4510	-	-
Super 22, Mini 23 / 26, Pro 26	0,70	BM7A	6521	10	6793

ALLEN - Tondeuses

215 / 216 / 218 ILO / 221 / 41, Greenfield 12	0,60	BMR6A	7421	01	5478
Merlin / Merlin XL / Lawnranger / Parkranger	0,60	BMR6A	7421	01	5478
Mot. B&S 4 hp, Mot. Tecumseh	0,70	BR2-LM	5798	06	4740
National 68 - Mot. B&S	0,60	BMR6A	7421	01	5478
National 68 - Mot. Kawasaki	0,60	BP4HS	3611	-	-
National 84	0,70	B-6L	3212	-	-

ALLEN - Tronçonneuses

HF 750	0,60	BM4A	5628	-	-
HT 230A	0,60	BM7A	6521	10	6793

ALLIS CHALMERS - Tronçonneuses

65, 75, 75A, 95, 195, 295	0,70	BMR6A	7421	01	5478
---------------------------	------	--------------	------	----	------

ALLIS-CHALMERS - Manutention

706B	0,60	BP5ES	6511	03	6854
Chore Boy - Mot. Winconsin, Chore Boy - Ø18mm	0,60	AB-6	2910	-	-
Chore Boy Mot. I.H.C., Chore Boy Mot. Waukesha	0,50	AB-6	2910	-	-
G-153 / 230 / 262, TL-10 / 12 / 14	0,60	B5ES	6410	-	-
TL-545G - Allis-Chalmers, TL-545G Mot. Buda	0,60	B-4	3210	-	-
TL-545G - Mot. B&S, TL-545G Mot. I.H.C.	0,60	B6S	3510	09	6048
TL-545G Mot. Onan CK	0,60	B-6L	3212	-	-
TL-545G Mot. Waukesha, TL-6 / 15	0,60	B6S	3510	09	6048
TL-545G - Autres modèles	0,60	B6ES	7310	-	-

ALPINA - Débroussailleuses

160 Green, 180 Jolly, 200 Prof	0,70	BPMR7A	4626	02	5959
232, 238, 332, 338, 540 i, 600 i	0,70	BPMR7A	4626	02	5959
Elite Stickle Bar	0,70	B6S	3510	09	6048
VIP- 21 NG / 25 DG / 34 DG / 42 DG	0,70	BPMR7A	4626	02	5959
VIP 34 / F / Duplex / Flex, 42 / D / F, 52	0,70	BPMR7A	4626	02	5959
VIP 52 D / Duplex / F / Flex, 56T, 66T	0,70	BPMR7A	4626	02	5959

ALPINA - Tondeuses

Mot. Aspera	0,50	B4-LM	3410	05	4358
Mot. Honda 4 / 5.5 hp	0,70	BPR5ES	7422	03	6854
Mot. Tecumseh 3.5 / 5 hp	0,70	BR2-LM	5798	06	4740

ALPINA - Tronçonneuses

0-70 / S / -90, 330 / 380 Mini	0,50	BPM7A	7321	02	5959
65 Disc Cutter	0,50	BPM6A	7021	08	5063
432 / 438 MiniProf, 540 Isofloat	0,50	BPM7A	7321	02	5959
540i / 600i	0,50	BPMR7A	4626	02	5959
Forest 120	0,50	BPM7A	7321	02	5959
MS 540i / 600i, MS P 34 / 400 / 450	0,70	BPMR7A	4626	02	5959
P 34	0,80	BPMR7A	4626	02	5959
P 540	0,50	BPMR7A	4626	02	5959
Prof 34 / 41 / 45 / 55 / 65 / 90 / 120, Prof P34	0,50	BPM7A	7321	02	5959
Prof 56 / 66 / 70	0,80	BPM7A	7321	02	5959
Prof 200	0,70	B6S	3510	09	6048
Tous modèles jusqu'à 1993	0,50	BPM6A	7021	08	5063
Vip 20 / 24 / 32	0,50	BPMR7A	4626	02	5959

Modèle

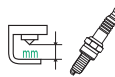
 N° STOCK BOÎTE
 N° BLISTER
 N° BLISTER

ALTO U.S. - Tondeuses

Mot. Kawasaki FD620D 20 hp	1,00	BMR2A-10	4452	-	-
----------------------------	------	----------	------	---	---

AMERICAN - Manutention

Economobile	0,60	AB-6	2910	-	-
-------------	------	------	------	---	---

AMERICAN COLEMAN - Manutention

MB-4 Manutention d'avions	0,60	B-4	3210	-	-
---------------------------	------	-----	------	---	---

AMERIND-MACKISSIC - Tronçonneuses

9-P	0,80	BR6S	3522	09	6048
-----	------	------	------	----	------

AMF - Tondeuses

Mot. B&S	0,70	BR2-LM	5798	06	4740
Mot. Tecumseh	0,70	BR6S	3522	09	6048

ARCTIC CAT - Générateurs

AC 750 GT 70cc 2 tps 1.8hp	0,60	BPR5HS	6222	-	-
AC 1400 G 119cc 4 tps 3.8 hp, AC 1800 GD	0,60	BPR6ES	7822	04	7678
AC 2200 G / 2500 G / GD 162cc 4 tps 5.3 hp	0,60	BPR6ES	7822	04	7678
AC 3000 GD2 252cc 4 tps 6.8 hp	0,60	BPR5HS	6222	-	-
AC 4000 GD2E / G2 272cc 4 tps 9 hp	0,70	BPR5ES	7422	03	6854
AC 7500 GD2E 419 cc 4 tps 14 hp	0,50	BR6ES	4922	-	-

ARCTIC ENTERPRISES - Tondeuses

Mot. B&S	0,70	BR2-LM	5798	06	4740
Mot. Sachs	0,70	BR6HS	3922	-	-

ARGO - Tondeuses

Mot. B&S	0,70	BR2-LM	5798	06	4740
----------	------	--------	------	----	------

ARIENS - Tondeuses

BladeRunner DESP21 / DSP21 - Honda GCV 5.5hp	0,70	BPR6ES	7822	04	7678
BladeRunner P21 / SP21 Mot. B&S Quantum 6.5hp	0,70	BR2-LM	5798	06	4740
Classic LM 21-911170 Kohler XT-7.75 173cc	0,70	BKR5ES	2460	07	4803
Classic LM 21S-911193 Kawa. FJ180V 179cc	0,80	BPR5ES	7422	03	6854
Classic LM 21SW-911194 Kawa. FJ180V	0,80	BPR5ES	7422	03	6854
HMZ2350 Mot. Kohler Courage 23 hp	0,70	BKR5ES	2460	07	4803
LM21S / SCH / SW Mot. Kawasaki 6 hp	0,60	BMR6A	7421	01	5478
LM21SCH Mot. Honda GXV 160 5.5 hp	0,70	BPR5ES	7422	03	6854
MiniZoom 1534 Mot. Kohler Courage 15 hp	0,70	BKR5ES	2460	07	4803
Mot. B&S Intek 6.5 / 6.75 hp / Intek OHV 10 hp	0,70	BKR5ES	2460	07	4803
Mot. B&S Intek OHV 12 hp / Intek OHV 14 hp	0,70	BKR5ES	2460	07	4803
Mot. B&S Quantum 6 hp	0,70	BR2-LM	5798	06	4740
Mot. Honda GCV 160 5.5 hp	0,70	BPR6ES	7822	04	7678
Mot. Honda GXV 160 5.5 hp	0,80	BPR5ES	7422	03	6854
Mot. Kawasaki 12.5 hp	0,70	BMR4A	5728	-	-
Mot. Kawasaki 9 hp / Mot. Kawasaki OHV 5 / 6 hp	0,70	BPR5ES	7422	03	6854
Mot. Kohler KT17 / KT19	0,70	BPR4FS	1127	-	-
Mot. Kohler KT181 8 hp	0,60	BR6S	3522	09	6048
Mot. Kohler Twin 8 hp	0,70	B2-LM	1147	06	4740
Mot. Kohler Twin 16 / 17 / 18 / 20 hp	0,60	UR4	6630	-	-
Mot. Lauson	0,60	B-4	3210	-	-
Mot. Sachs	0,70	B-4H	4110	-	-
Mot. Sachs SB140	0,70	BPMR7A	4626	02	5959
Mot. Tecumseh 6 hp	0,70	BR2-LM	5798	06	4740
Mot. Tecumseh L-Head 8.5 hp	0,50	B6S	3510	09	6048
Mot. Tecumseh OHV 9 / 11.5 / 13 hp	0,70	BR6ES	4922	-	-
Mot. Tecumseh OHV 16.5 hp	0,70	B6ES	7310	-	-
Pro24 BrushCutter-911707 B&S 344cc 11.5hp	0,70	BKR5ES	2460	07	4803
Pro24 HWS-911703 Mot. B&S 190cc	0,50	BKR5ES	2460	07	4803
RER1028 Mot. B&S OHV 10 hp	0,70	BR2-LM	5798	06	4740
RER1232 Mot. B&S OHV 12 hp	0,70	BR2-LM	5798	06	4740
RER1450 Mot. B&S OHV 14 hp	0,70	BR2-LM	5798	06	4740
RER10528 Mot. B&S OHV 10.5 hp	0,70	BR2-LM	5798	06	4740
RER14532 Mot. B&S OHV 14.5 hp	0,70	BKR5ES	2460	07	4803
SportZoom1232 Mot. B&S OHV 12 hp	0,70	BR2-LM	5798	06	4740
Value 21-961468 550E B&S 149cc	0,50	BKR5ES	2460	07	4803
Value 21-961469 Honda GCV 160 160CC	0,80	BPR6ES	7822	04	7678
Wide Area Walk 34-911413 B&S 500cc 14.5hp	0,70	BKR5ES	2460	07	4803

Modèle

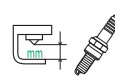
 N° STOCK BOÎTE
 N° BLISTER
 N° BLISTER

Zoom 34-915157 Mot. B&S 500cc 14.5hp	0,70	BKR5ES	2460	07	4803
Zoom1540 Mot. B&S OHV 15hp	0,70	BKR5ES	2460	07	4803
Zoom1540 Mot. Kohler Courage 15hp	0,70	BKR5ES	2460	07	4803
Zoom1640 Mot. B&S OHV 16hp	0,70	BKR5ES	2460	07	4803
Zoom1740 Mot. Kohler Courage 17hp	0,70	BKR5ES	2460	07	4803
Zoom1840 / XL Mot. Kohler Courage 18hp	0,70	BKR5ES	2460	07	4803
Zoom1844XL Mot. Kohler Courage 18hp	0,70	BKR5ES	2460	07	4803
Zoom1944 Mot. B&S OHV 19hp	0,70	BKR5ES	2460	07	4803
Zoom1944 Mot. Kohler Command 19hp	0,70	BKR5ES	2460	07	4803
Zoom2044XL / XLP Mot. Kohler Courage 20hp	0,70	BKR5ES	2460	07	4803
Zoom2148 / XL Mot. Kohler OHV Twin 21hp	0,70	BKR5ES	2460	07	4803
Zoom2348XL / XLP Mot. Kohler Courage 23hp	0,70	BKR5ES	2460	07	4803
Zoom2350 Mot. Kohler Courage 23hp	0,70	BKR5ES	2460	07	4803
Zoom2352 Mot. Kohler OHV Twin 23hp	0,70	BKR5ES	2460	07	4803
Zoom2552XL / 2560XL Mot. Kohler 25hp	0,70	BKR5ES	2460	07	4803
ZoomMZ1434 / 1534 Mot. B&S OHV 14hp	0,70	BKR5ES	2460	07	4803
ZoomMZ1434 / 1534 Mot. Kohler Cour. 15hp	0,70	BKR5ES	2460	07	4803
ZoomMZ1540 Mot. Kohler Courage 15hp	0,70	BKR5ES	2460	07	4803

ARIES - Tondeuses

Mot. B&S, Mot. Tecumseh	0,70	BR2-LM	5798	06	4740
-------------------------	------	--------	------	----	------

ARTICULATOR - Tondeuses

Mot. Kohler 22 / 25 hp, Mot. Kohler EFI 28 hp	0,80	BKR5E	7938	07	4803
---	------	-------	------	----	------

AS MOTOR - Générateurs

AS 120 A / C / D, AS 165 H	0,60	B6HS	4510	-	-
AS 165 Kat	0,50	B6HS-5	6154	-	-
S-B 6	0,60	B6HS	4510	-	-

AS MOTOR - Tondeuses

AS 21 165-2 / AH4 / AH6 / AH9 / H3 / H6	0,50	B6HS-5	6154	-	-
AS 21 165-3-Kat / 26 AH 9-3-Kat	0,50	B6HS-5	6154	-	-
AS 26 AH4 / AH6 / AH8 / AH9 / H4 / H6 / H8	0,50	B6HS-5	6154	-	-
AS 28 4 Enduro-Kat	0,50	B6HS-5	6154	-	-
AS 42 B 6, AS 45 B 2-2 / B 3 A / B 4-Kat	0,50	B6HS-5	6154	-	-
AS 45 B4-Kat / 65 2T Enduro-Kat, AS 46 B 1 / B 2	0,50	B6HS-5	6154	-	-
AS 53 B1 / B1R / B3 / B5 / B5R / B8 / 120 / 165	0,50	B6HS-5	6154	-	-
AS 53 B4-Kat / B5-Kat / B6 RB-Kat	0,50	B6HS-5	6154	-	-
AS 65 2T Enduro-Kat	0,50	B6HS-5	6154	-	-
AS 120 A / C / D	0,60	B6HS	4510	-	-
AS 165 A / D / E / F / G / H / I / K / L / M / N	0,60	B6HS	4510	-	-
AS 480 2T MK-Kat / 530 2T MK-Kat	0,50	B6HS-5	6154	-	-
AS 480 2T-Kat / 530 2T-Kat	0,60	B6HS	4510	-	-
AS 530 4T MK / 560 KM / 620 KM	0,70	BPR6ES	7822	04	7678
AS 560 KM / 620 KM	0,90	BPR6ES	7822	04	7678

ASPERA ENGINES (TECNAMOTOR) - Gén.

AV 125 / 520 / 600 / 750	0,60	BR4-LM	4133	05	4358
AW 520 / 520P / 521 / 525	0,60	BR6S	3522	09	6048
AW 750 / 755	0,60	BM6A	5921	01	5478
BV 133 / 150 / 153 / 172 / 173	0,60	BR4-LM	4133	05	4358
H 30 / 35, HB 30 / 35, H7HS, HBL	0,60	BR4-LM	4133	05	4358
HBL 25 / 30 / 35 / 40	0,60	BR6S	3522	09	6048
HS 25 / 30 / 35 / 40, LAVR 35 / 40	0,60	BR6S	3522	09	6048
HS, HLB 30, LAV 30 / 35 / 40 / 153 / 172	0,60	BR4-LM	4133	05	4358
LAV 30 / 35 / 40 / 153 / 172, MV 100/100S	0,60	BR4-LM	4133	05	4358
SE 600 / 600 P / 601 / 605	0,60	BR6S	3522	09	6048

ASTRON - Débroussailleuses

150 / 200 / 250	0,70	BMR6A	7421	01	5478
AS-110 Mot. Yamaha	0,80	B5HS	4210	-	-
E202, HT-766, HT-830 Mot. Kawa. K12AD 1.2hp	0,60	BM6A	5921	01	5478
E-203DC Mot. 22.6cc TF22-DVXC	0,80	BM6A	5921	01	5478
HT-470 Mot. 18.4cc TG18-DVXC	0,80	BM6A	5921	01	5478
HT-767T Mot. 22.6cc TF22-DVXC	0,80	BM6A	5921	01	5478
HT-838 Mot. 22.6cc TF22-DVX	0,80	BM6A	5921	01	5478
KFS4-12AD, KFS4-24DX Mot. Kawa.K12AD 1.2hp	0,70	BM6A	5921	01	5478
KFS4T-25G - Mot. TG25-DX 25.1cc	0,70	BMR6A	7421	01	5478
PK 2500F / 2860G / 3330G	0,70	BMR6A	7421	01	5478
PK-2500G Mot. 25.1cc TG25-DX	0,70	BM6A	5921	01	5478
PK-2860G Mot. 28.6cc TG28-DXC	0,70	BM6A	5921	01	5478
Pro 750E Mot. 1.2 hp Kawasaki TA-33	0,70	BM6A	5921	01	5478

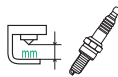

PS-35302	0,70	BPMR7A	4626	02	5959
S-160ED-8	0,70	BMR6A	7421	01	5478
Super 100, 150, 160 Mot. ST-16 Shingu	0,70	BM6A	5921	01	5478

ATCO - Tondeuses

Mot. B&S	0,70	BR2-LM	5798	06	4740
Mot. JAP Ø14 mm	0,80	B5HS	4210	-	-
Mot. Suffolk / Tecumseh	0,70	B6S	3510	09	6048
Mot. Villiers 18 mm	0,80	AB-6	2910	-	-
Mot. Villiers Ø14 mm	0,80	B5HS	4210	-	-

ATIKA - Débroussailleuses

BAE 30	0,60	BPMR7A	4626	02	5959
BT 25	0,50	BPMR7A	4626	02	5959

ATIKA - Générateurs

LC 170 F	0,70	BPR7ES	2023	-	-
----------	------	--------	------	---	---

ATIKA - Tronçonneuses

BKS 38 A / 45	0,60	BPMR7A	4626	02	5959
---------------	------	--------	------	----	------

ATLAMATIC - Manutention

Mot. Volkswagen	0,60	B5HS	4210	-	-
-----------------	------	------	------	---	---

ATLAS - Générateurs

Mot. B&S 3 / 5 / 8 hp	0,70	B2-LM	1147	06	4740
-----------------------	------	-------	------	----	------

ATLAS - Tondeuses

Mot. B&S	0,70	BR2-LM	5798	06	4740
Mot. Lauson	0,80	B6S	3510	09	6048
Mot. Tecumseh	0,70	BR6S	3522	09	6048

AUTOMOTIVE - Manutention

GLF, GLT, GMF - Essence / GPL	0,60	AB-6	2910	-	-
-------------------------------	------	------	------	---	---

BACHTOLD BROS., INC. - Débroussailleuses

Mot. B&S Intek 6 hp	0,80	BKR5ES	2460	07	4803
Mot. B&S Quantum 5 hp	0,80	BR2-LM	5798	06	4740
Mot. Honda GX140 5 hp	0,70	BPR6ES	7822	04	7678

BACHTOLD - Tondeuses

Mot. B&S, Mot. Kohler K181 8 hp	0,70	BR2-LM	5798	06	4740
---------------------------------	------	--------	------	----	------

BAD BOY MOWERS - Tondeuses

Mot. Kawasaki FH580V 19 hp	0,60	BCPR6ES	2330	-	-
----------------------------	------	---------	------	---	---

BAD BOY - Tondeuses

AOS - Mot. B&S Vanguard (Refr. Air) 35hp	0,70	BKR5ES	2460	07	4803
AOS - Mot. Kawasaki (Refr. Liquide). 27 hp	0,80	BPR2ES	2264	-	-
LightningZ - B&S Vanguard (Refr. Air) 32hp	0,70	BKR5ES	2460	07	4803
LightningZ - Kawasaki (Refr. Liquide). 26hp	0,80	BPR2ES	2264	-	-
Mot. B&S Intek V-Twin 25 hp, Vanguard 31 h	0,70	BKR5E	7938	07	4803
Mot. Kawasaki OHV 27 hp	0,80	BPR4ES	7222	-	-
Mot. Kawasaki V-Twin 26 / 27 hp	0,80	BPR5ES	7422	03	6854
Mot. Kohler V-Twin 27 hp	0,80	BPR5ES	7422	03	6854
PupSeries- B&S Vanguard (Refr. Air) 23hp	0,70	BKR5ES	2460	07	4803
PupSeries- Kohler Command (Refr. Air) 30hp	0,70	BKR5ES	2460	07	4803
ZT-Series - Mot. B&S Intek (Refr. Air) 26 hp	0,70	BKR5ES	2460	07	4803

BAKER - Manutention

Ø14mm	0,60	B6S	3510	09	6048
Ø18mm	0,60	AB-6	2910	-	-

BARRUS - Tondeuses

Mot. B&S	0,50	B4-LM	3410	05	4358
----------	------	-------	------	----	------

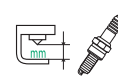

BEAIRD-POULAN - Débroussailleuses

Line 2600 350 cc	0,60	BM4A	5628	-	-
Line 770	0,60	BMR6A	7421	01	5478

BEAMAN - Tondeuses

Culasse Ø18 mm	0,60	AB-6	2910	-	-
----------------	------	------	------	---	---

BEAR CAT - Débroussailleuses

73455 / 74455 - Mot. Honda OHC 5.5 hp	0,80	BPR6ES	7822	04	7678
Mot. B&S 3.75 / 4 / 5 / 6 hp	0,70	BR2-LM	5798	06	4740
Mot. Honda OHC / OHC Twin	0,80	BPR6ES	7822	04	7678

BEAR CAT - Tondeuses

Mot. B&S	0,70	BR2-LM	5798	06	4740
Mot. Honda OHV 5 hp	0,80	BPR6ES	7822	04	7678

BEAZLEZ - Tondeuses

Culasse Ø14 mm	0,70	BR6S	3522	09	6048
Culasse Ø18 mm	0,60	AB-6	2910	-	-

BEFCO - Tondeuses

Mot. B&S 10.5 hp	0,70	BR2-LM	5798	06	4740
Mot. Kohler 8 hp	0,70	B-6L	3212	-	-

BERNARD - Générateurs

Mots industriels	0,60	B6HS	4510	-	-
------------------	------	------	------	---	---

BERNARD - Tondeuses

Autres modèles	0,60	BR6HS	3922	-	-
Ø18 mm	0,60	AB-6	2910	-	-

BERNARD - Tronçonneuses

BM 230, 230.1, 236.3, 441.3, 651.3	0,60	BMR6A	7421	01	5478
------------------------------------	------	-------	------	----	------

BFB - Tondeuses

Mot. B&S OHV 12.5 / 15.5 hp	0,90	BKR5E	7938	07	4803
Mot. B&S Twin Vanguard 16 / 18 / 20 hp	0,90	BKR5E	7938	07	4803

BIG-PRO - Tondeuses

Mot. Kohler Twin 18 / 20 hp	0,60	BPR4FS	1127	-	-
-----------------------------	------	--------	------	---	---

BLACK ROCK - Débroussailleuses

Grass, Hedge	0,70	BMR6A	7421	01	5478
--------------	------	-------	------	----	------

BLACK ROCK - Tondeuses

Mot. B&S 8 / 11 hp	0,70	BR2-LM	5798	06	4740
Mot. B&S Vanguard 12.5 hp	0,80	BKR5E	7938	07	4803
Mot. Kawasaki 2.4 hp	0,80	BMR6A	7421	01	5478
Mot. Kawasaki OHV 14 hp, V-Twin 17 / 21 / 25 hp	0,80	BPR5ES	7422	03	6854
Mot. Kohler V-Twin 22 hp	0,80	BKR5E	7938	07	4803

BLITZ - Débroussailleuses

27S / D / T, 33S / T, 40S / T	0,60	BPMR7A	4626	02	5959
-------------------------------	------	--------	------	----	------

BLITZ - Tronçonneuses

B 34 / 35 / 38 / 42 / 45 / 50 / 52 / 54 / 55 / 60 / 64	0,50	BPMR7A	4626	02	5959
B 80 / 100 / 300 / 304 / 400 / 404 / 500 / 502	0,50	BPMR7A	4626	02	5959
B 504 / 600 / 701 / 702 / 800 / 802 / 804, XB502	0,50	BPMR7A	4626	02	5959

BLUE BIRD - Débroussailleuses

H23E, H27E	0,60	BM7A	6521	10	6793
------------	------	------	------	----	------

BLUE BIRD - Tondeuses

Mot. B&S 12.5 hp	0,70	BR2-LM	5798	06	4740
Mot. B&S Twin Vanguard 16 hp	0,80	BCPR5ES	6130	07	4803
Mot. Honda OHV 5 hp	0,90	BPR6ES	7822	04	7678

Modèle

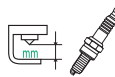
 N° STOCK
BLISTER
BOÎTE

BOB-A-LAWN - Tondeuses

Tous modèles	0,70	BR2-LM	5798	06	4740
--------------	------	---------------	-------------	-----------	-------------

BOBCAT - Manutention

Skid-Steers - Ess. / GPL Mot. Kohler 24hp	0,80	B2-LM	1147	06	4740
Skid-Steers - Essence / GPL Onan CCK	0,60	B-6L	3212	-	-
Skid-Steers - Mot. Ford 98 ci.	0,90	BPR5ES	7422	03	6854
Skid-Steers - Mot. Kohler Twin 16 / 18 hp	0,70	UR4	6630	-	-
Skid-Steers - Mot. Mitsubishi 36 hp	1,10	BPR4ES-11	4224	-	-
Skid-Steers - Mot. Winconsin VH4D	0,60	AB-6	2910	-	-

BOBCAT - Tondeuses

42311H Fastcat RZ42 - B&S Pro. V-Twin 23hp	0,70	BKR5ES	2460	07	4803
933007G, 934007G Mot. Kawasaki FS481V	0,70	BPR4ES	7222	-	-
933305G, 932007G Mot. Kawasaki FS481V	0,70	BPR4ES	7222	-	-
934306G, 933307G Mot. Kawasaki FS541V	0,70	BPR4ES	7222	-	-
934307G, 934332G Mot. Kawasaki FS541V	0,70	BPR4ES	7222	-	-
935308G, 935333G Mot. Kawasaki FS600V	0,70	BPR4ES	7222	-	-
942297H Fastcat Pro SE 36 Kawa. FX541V	0,70	BPR4ES	7222	-	-
942298H Fastcat Pro SE 48 Kawa. FX600V	0,70	BPR4ES	7222	-	-
942299H Fastcat Pro SE 52 Kohler ECV730 EFI	0,70	BPR4ES	7222	-	-
942302H Fastcat Pro SE 42 Kawa. FX600V	0,70	BPR4ES	7222	-	-
942315H Fastcat RZ 52 Mot. Kawa. FR651V	0,70	BPR4ES	7222	-	-
942316J Fastcat RZ 61 Mot. Kawa. FR691V	0,70	BPR4ES	7222	-	-
942406H Fastcat Pro 52 Kawa. FX691V	0,70	BPR4ES	7222	-	-
942407J Fastcat Pro 61 Mot. Kawa. FX730V	0,70	BPR4ES	7222	-	-
942408H Fastcat Pro 52 Kohler ECV730 EFI	0,70	BKR5ES	2460	07	4803
942409J Fastcat Pro 61 Kohler ECV749 EFI	0,70	BKR5ES	2460	07	4803
942501J Procat 52 Mot. Kawa. FX730V	0,70	BPR4ES	7222	-	-
942502J, 942504J Procat 61 Mot. Kawa. FX730V	0,70	BPR4ES	7222	-	-
942506J Procat 52 Mot. Kawasaki FX801V	0,70	BPR4ES	7222	-	-
942507J Procat 61 Mot. Kawasaki FX801V	0,70	BPR4ES	7222	-	-
942508J Procat 72 Mot. Kawasaki FX801V	0,70	BPR4ES	7222	-	-
942509J, 942511J Mot. Generac Indus. OHVI LP	1,00	BKR5ES	2460	07	4803
942514J Predator-Pro 61 Kawa. FX921V-DFI	0,70	BPR5ES	7422	03	6854
942515J Predator-Pro 61 Kawa. FX921V-DFI	0,70	BPR5ES	7422	03	6854
942516J Predator-Pro DFI 72 Kawa. FX1000V	0,70	BPR5ES	7422	03	6854
942517J Procat 48 Mot. Kawasaki FX651V	0,70	BPR4ES	7222	-	-
942519J Predator-Pro 72 Kawa. FX921V-DFI	0,70	BPR5ES	7422	03	6854
942520J Procat SE52 Kohler Com. Pro CV680	0,70	BKR5ES	2460	07	4803
942521J Procat SE61 Kohler Com. Pro CV740	0,70	BKR5ES	2460	07	4803
942522J Procat SE 52 Mot. Kawasaki FX651V	0,70	BPR4ES	7222	-	-
942523J Procat SE 61 Mot. Kawa. FX730V	0,70	BPR4ES	7222	-	-
942524J Mot. Generac Indus. OHVI LP	1,00	BKR5ES	2460	07	4803
942525J Procat 52 Mot. Kohler ECH730 EFI	0,70	BKR5ES	2460	07	4803
942526J Procat 61 Mot. Kohler ECV749 EFI	0,70	BKR5ES	2460	07	4803
942600 CRZ48 Mot. Kawasaki FR600V	0,70	BPR4ES	7222	-	-
942601 CRZ52 Mot. Kawasaki FR651V	0,70	BPR4ES	7222	-	-
942602 CRZ61 Mot. Kawasaki FR651V	0,70	BPR4ES	7222	-	-
DMG950G - Mot. B&S 31 hp	0,80	BKR5E	7938	07	4803
Mot. B&S	0,70	B2-LM	1147	06	4740
Mot. B&S ELS 15 hp	0,70	BR2-LM	5798	06	4740
Mot. B&S Intek V-Twin OHV 18 / 26 hp	0,70	BKR5ES	2460	07	4803
Mot. Kawasaki V-Twin OHV 19 / 23 / 25 hp	0,80	BPR4ES	7222	-	-
Mot. Kawasaki V-Twin Refroid. Air 15 / 17 hp	0,60	BCPR6ES	2330	-	-
Mot. Kohler Aegis V-Twin OHV 23 hp	0,70	BKR5ES	2460	07	4803
Mot. Kohler Command Pro Refroid. Air 15 hp	1,10	BKR5ES-11	2382	-	-
Mot. Kohler Command Pro V-Twin OHV 28 hp	0,70	BKR5ES	2460	07	4803

BOLENS - Débroussailleuses

BL110, BL160 Mot. 25cc, 2 tps EZ Pull	0,60	BPMR6F	1270	-	-
Remington RM2510 Rustler 2 tps Quick Start 25cc	0,60	BPMR6F	1270	-	-
Remington RM2520 Mot. 2 tps Quick Start 25cc	0,60	BPMR6F	1270	-	-
Remington RM2560 Mot. 2 tps Quick Start 25cc	0,60	BPMR6F	1270	-	-
Remington RM2570 Mot. 2 tps Quick Start 25cc	0,60	BPMR6F	1270	-	-

BOLENS - Manutention

GK Modèle 960	0,60	AB-6	2910	-	-
---------------	------	-------------	-------------	---	---

BOLENS - Tondeuses

11A-020L765 Mot. B&S 148cc	0,70	BKR5ES	2460	07	4803
11A-B06R765 Mot. B&S 140cc	0,50	BKR5ES	2460	07	4803

Modèle

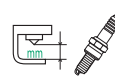
 N° STOCK
BLISTER
BOÎTE

13W1762F065 Mot. B&S 13.5 hp	0,70	BKR5ES	2460	07	4803
13W1762F265 Riding mower Mot. B&S 13.5hp	0,70	BKR5ES	2460	07	4803
HH140 Mot. Tecumseh 14 hp	0,60	BR6HS	3922	-	-
HH160 Mot. Tecumseh 16 hp	0,60	BR6HS	3922	-	-
Mot. B&S 4.5 hp	0,70	BR2-LM	5798	06	4740
Mot. B&S 15 / 15.5 hp, Mot. B&S OHV 17 hp	0,70	BKR5ES	2460	07	4803
Mot. B&S OHV V-Twin 20 / 21 / 22 hp	0,70	BKR5ES	2460	07	4803
Mot. B&S Quantum 5.5 hp	0,70	BR2-LM	5798	06	4740
Mot. Generac 33 hp	0,70	BKR4E	4421	-	-
Mot. Kohler 18 / 19 / 20 / 23 hp	0,70	B-6L	3212	-	-
Mot. Kohler K361 18 hp, K532 20 hp, K582 23 hp	0,60	B-6L	3212	-	-
Mot. Lauson	0,60	B6S	3510	09	6048
Mot. Products	0,50	B6S	3510	09	6048
Mot. Wisconsin	0,80	AB-6	2910	-	-

BOLENS - Tronçonneuses

3300 / 5500 / 5600 / 5700	0,70	B-4L	3112	-	-
Mot. B&S	0,60	B2-LM	1147	06	4740
Mot. Tecumseh	0,70	B6S	3510	09	6048
Remington RM5118R 51cc 2Tps Quickstart	0,60	BPMR6F	1270	-	-
Remington RM5520R 55cc 2Tps Quickstart	0,60	BPMR6F	1270	-	-



BOMBARDIER-ROTAX - Générateurs

150 / 299 / 500	0,60	AB-6	2910	-	-
635	0,60	AB-7	3010	-	-
95 / 182 / 232	0,60	B6HS	4510	-	-

BRIGGS & STRATTON - Générateurs

10000 V-Twin Vanguard 18hp	0,70	BKR5E	7938	07	4803
100000 Single Cyl. "L" head 3.5hp	0,80	BR2-LM	5798	06	4740
100200 Single Cyl. "L" head 4hp	0,70	BR2-LM	5798	06	4740
100202 Single Cyl. "L" head 4hp	0,70	B2-LM	1147	06	4740
100600 Series Single Cyl. "L" Head	0,70	BR2-LM	5798	06	4740
100700 Single Cyl. "L" head 3.5hp, 100708 3.5hp	0,70	BR2-LM	5798	06	4740
100900 Single Cyl. "L" head 4hp	0,70	BR2-LM	5798	06	4740
104000 OHV 4.5hp, 104700 OHV Vanguard 5hp	0,80	BKR5ES	2460	07	4803
104700 Series Single Cyl. "L" Head	0,70	BR2-LM	5798	06	4740
10A900 & 10B900 Single Cyl. "L" head 4hp	0,70	BR2-LM	5798	06	4740
10C900 & 10D900 Series Single Cyl. "L" Head	0,70	BR2-LM	5798	06	4740
10E900 & 10F900 Series Single Cyl. "L" Head	0,70	BR2-LM	5798	06	4740
10G900 & 10L900 Series Single Cyl. "L" Head	0,70	BR2-LM	5798	06	4740
10M900 Series Single Cyl. "L" Head	0,70	BR2-LM	5798	06	4740
10T502-0174	0,70	BR2-LM	5798	06	4740
110000 Single Cyl. "L" head 4hp	0,80	BR2-LM	5798	06	4740
110400 Single Cyl.OHV Intek 5.5hp	0,70	BKR5ES	2460	07	4803
110412-0173	0,70	BKR5ES	2460	07	4803
110600 Single Cyl.OHV Intek 6.5hp	0,70	BKR5ES	2460	07	4803
110700 / 110900 Single Cyl. "L" head 4hp	0,70	BR2-LM	5798	06	4740
111000 Single Cyl. "L" head 4hp	0,80	BR2-LM	5798	06	4740
111200 4hp	0,70	BR2-LM	5798	06	4740
111400 Single Cyl.OHV Intek 5.5hp	0,70	BKR5ES	2460	07	4803
111600 Single Cyl.OHV Intek 6.5hp	0,70	BKR5ES	2460	07	4803
111700 / 111900 Series Single Cyl. "L" Head	0,70	BR2-LM	5798	06	4740
112000 Single Cyl. "L" head 4hp, 112200 4 hp	0,70	B2-LM	1147	06	4740
113000 Single Cyl. "L" head 4hp	0,80	BR2-LM	5798	06	4740
113400 Single Cyl.OHV Intek 5.5hp	0,70	BKR5ES	2460	07	4803
113900 4hp	0,70	B2-LM	1147	06	4740
114000 Single Cyl. "L" head 4hp	0,80	BR2-LM	5798	06	4740
114700 4hp	0,70	B2-LM	1147	06	4740
115400 Single Cyl.OHV Vanguard 5.5hp	0,70	BKR5ES	2460	07	4803
117400 Single Cyl.OHV Vanguard 6hp	0,70	BKR5ES	2460	07	4803
117432 Intek 6hp	0,70	BCPR5ES	6130	07	4803
118400 Series Vanguard Single Cyl. OHV	0,70	BPR6HS	7022	-	-
11A600 / 11B600 Series Single OHV	0,50	BKR5E	7938	07	4803
11C600 Series Intek Single Cyl. OHV	0,50	BKR5E	7938	07	4803
120300 Series Single OHV	0,70	BKR5E	7938	07	4803
120400 / 120600 Single Cyl.OHV Intek 6.5hp	0,70	BKR5ES	2460	07	4803
120H00 / 120J00 Series Single Cyl. "L" Head	0,70	BR2-LM	5798	06	4740
121000 Single Cyl. "L" head 3.5hp	0,80	BR2-LM	5798	06	4740
121300 Series Intek Single Cyl. OHV	0,70	BKR5E	7938	07	4803
121400 / 121600 Single Cyl.OHV Intek 6.5hp	0,70	BKR5ES	2460	07	4803
121700 3.5hp, 121800 Series Single Cyl. "L" Head	0,70	BR2-LM	5798		

Modèle		N°			Modèle		N°				
		STOCK	BLISTER	STOCK			BOÎTE	BLISTER	STOCK	BLISTER	STOCK
122600 Single Cyl.OHV Intek 6.5hp	0,70	BKR5ES	2460	07	4803	12U800 Series Single Cyl. "L" Head	0,70	BR2-LM	5798	06	4740
122700 / 122800 Series Single Cyl. "L" Head	0,70	BR2-LM	5798	06	4740	12V000 Single Cyl. "L" head 6hp	0,80	BR2-LM	5798	06	4740
122H00 / 122K00 Series Single Cyl. "L" Head	0,70	BR2-LM	5798	06	4740	12V800 Series Single Cyl. "L" Head	0,70	BR2-LM	5798	06	4740
123000 Single Cyl. "L" head 4hp	0,80	BR2-LM	5798	06	4740	12W000 Single Cyl. "L" head 6hp	0,80	BR2-LM	5798	06	4740
123300 / 123600 Series Intek Single Cyl. OHV	0,70	BKR5E	7938	07	4803	12W800 / 12X800 Series Single Cyl. "L" Head	0,70	BR2-LM	5798	06	4740
123400 Single Cyl.OHV Intek 6.5hp	0,70	BKR5ES	2460	07	4803	12Y600 Series Marine Single OHV	0,70	BKR5E	7938	07	4803
123700 / 123H00 Series Single Cyl. "L" Head	0,70	BR2-LM	5798	06	4740	12Y800 Series Single OHV	0,70	BKR5E	7938	07	4803
123J00 / 123K00 Series Single Cyl. "L" Head	0,70	BR2-LM	5798	06	4740	12Z600 Series Intek Single Cyl. OHV	0,50	BKR5E	7938	07	4803
124000 Single Cyl. "L" head 5hp	0,80	BR2-LM	5798	06	4740	12Z800 Series Single OHV	0,70	BKR5E	7938	07	4803
124600 Series Intek Single Cyl. OHV	0,70	BKR5E	7938	07	4803	130000 Single Cyl. "L" head 5hp	0,80	BR2-LM	5798	06	4740
124700 5hp	0,80	BR2-LM	5798	06	4740	130200 / 130202 / 130900 5hp	0,70	B2-LM	1147	06	4740
124H00 / 124K00 Series Single Cyl. "L" Head	0,70	BR2-LM	5798	06	4740	131000 Single Cyl. "L" head 5hp	0,80	BR2-LM	5798	06	4740
125000 Single Cyl. "L" head 5hp	0,80	BR2-LM	5798	06	4740	131200 / 131400 / 131700 / 131900 5hp	0,70	B2-LM	1147	06	4740
125300 / 125400 Series ELS-Extended Life Serie	0,70	BKR5E	7938	07	4803	132000 Single Cyl. "L" head 5hp	0,80	BR2-LM	5798	06	4740
125600 Series Intek Single Cyl. OHV	0,50	BKR5E	7938	07	4803	132200 5 hp	0,70	B2-LM	1147	06	4740
125H00 / 125K00 Series Single Cyl. "L" Head	0,70	BR2-LM	5798	06	4740	132900 5 hp, 133200 5.5hp	0,70	BR2-LM	5798	06	4740
126000 Single Cyl. "L" head 5hp	0,80	BR2-LM	5798	06	4740	133200 Single Cyl. "L" head 5hp	0,80	BR2-LM	5798	06	4740
126300 / 126400 Series Single OHV	0,70	BKR5E	7938	07	4803	133237-0136, 133400 5 hp, 133400 5.5 hp	0,70	BR2-LM	5798	06	4740
126600 Series Intek Single Cyl. OHV	0,50	BKR5E	7938	07	4803	133400 Single Cyl. "L" head 5hp	0,80	BR2-LM	5798	06	4740
126700 4.5hp	0,70	BR2-LM	5798	06	4740	133700 5.5hp	0,70	BR2-LM	5798	06	4740
126H00 Series Single Cyl. "L" Head	0,70	BR2-LM	5798	06	4740	133700 Single Cyl. "L" head 6hp	0,80	BR2-LM	5798	06	4740
127300 Series Intek Single Cyl. OHV	0,70	BKR5E	7938	07	4803	134200 Series Single Cyl. "L" Head	0,70	BR2-LM	5798	06	4740
127400 / 127600 Series Intek Single Cyl. OHV	0,50	BKR5E	7938	07	4803	134400 Single Cyl. "L" head 5.5hp	0,80	BR2-LM	5798	06	4740
127700 / 127800 Series Single Cyl. "L" Head	0,70	BR2-LM	5798	06	4740	135200 5 hp, 135200 5.5hp	0,70	BR2-LM	5798	06	4740
128000 Single Cyl. "L" head 3.5hp	0,80	BR2-LM	5798	06	4740	135200 Single Cyl. "L" head 5hp	0,80	BR2-LM	5798	06	4740
128300 / 128400 Series Intek Single Cyl. OHV	0,70	BKR5E	7938	07	4803	135202-0271, 135400 Series Single Cyl. "L" Head	0,70	BR2-LM	5798	06	4740
128600 Series Intek Single Cyl. OHV	0,50	BKR5E	7938	07	4803	135700 Single Cyl. "L" head 6hp	0,80	BR2-LM	5798	06	4740
128700 Series Single Cyl. "L" Head	0,70	BR2-LM	5798	06	4740	136200 Single Cyl. "L" head 5hp	0,80	BR2-LM	5798	06	4740
128800 5.5hp	0,70	BR2-LM	5798	06	4740	137000 Single Cyl. "L" head 5.5hp	0,80	BR2-LM	5798	06	4740
128800 / 128H00 Series Single Cyl. "L" Head	0,70	BR2-LM	5798	06	4740	137200 Series Single Cyl. "L" Head	0,70	BR2-LM	5798	06	4740
129000 Single Cyl. "L" head 5.5hp	0,80	BR2-LM	5798	06	4740	138400 serie Single Cyl. OHV Vanguard 7.5hp	0,70	BKR5ES	2460	07	4803
129400 Series Intek Single Cyl. OHV	0,70	BKR5E	7938	07	4803	138432 7.5hp	0,70	BCPR5ES	6130	07	4803
129600 Series Intek Single Cyl. OHV	0,50	BKR5E	7938	07	4803	142300 / 142400 Series Single Cyl. "L" Head	0,70	BR2-LM	5798	06	4740
129700 / 129800 5.5hp	0,70	BR2-LM	5798	06	4740	142700 Series Single Cyl. "L" Head	0,70	BR2-LM	5798	06	4740
129700 / 129800 Series Single Cyl. "L" Head	0,70	BR2-LM	5798	06	4740	146400 6hp, 146700 6hp	0,80	BR2-LM	5798	06	4740
129H00 Series Single Cyl. "L" Head	0,70	BR2-LM	5798	06	4740	15A100 / 15B100 Series Intek Single Cyl. OHV	0,70	BKR5E	7938	07	4803
12A000 Single Cyl. "L" head 4.75hp	0,80	BR2-LM	5798	06	4740	160000 serie OHV 8.5hp	0,70	BKR5ES	2460	07	4803
12A300 / 12A400 Series Intek Single Cyl. OHV	0,70	BKR5E	7938	07	4803	161400 serie OHV Single Cyl. Vang. 9hp	0,70	BCPR5ES	6130	07	4803
12A600 Series Intek Single Cyl. OHV	0,50	BKR5E	7938	07	4803	170400 Single Cyl. "L" head 7hp	0,70	BR2-LM	5798	06	4740
12A800 Series Single Cyl. "L" Head	0,70	BR2-LM	5798	06	4740	170402 7hp, 170700 Single Cyl. "L" head 6.5hp	0,70	BR2-LM	5798	06	4740
12B000 Single Cyl. "L" head 5.25hp	0,80	BR2-LM	5798	06	4740	171400 Single Cyl. "L" head 7hp	0,70	BR2-LM	5798	06	4740
12B300 / 12B400 Series Intek Single Cyl. OHV	0,70	BKR5E	7938	07	4803	171700 Series Single Cyl. "L" Head	0,70	BR2-LM	5798	06	4740
12B600 Series Intek Single Cyl. OHV	0,50	BKR5E	7938	07	4803	176400 Single Cyl. "L" head 7hp, 17U000 7hp	0,80	BR2-LM	5798	06	4740
12B700 / 12B800 Series Single Cyl. "L" Head	0,70	BR2-LM	5798	06	4740	185400 serie OHV Single Cyl. Vanguard 9hp	0,70	BCPR5ES	6130	07	4803
12C000 Single Cyl. "L" head 5.25hp	0,80	BR2-LM	5798	06	4740	186400 Series Vanguard Single Cyl. OHV	0,70	BKR5E	7938	07	4803
12C300 / 12C400 Series Intek Single Cyl. OHV	0,70	BKR5E	7938	07	4803	190000 8hp, 190400 Single Cyl. "L" head 8hp	0,80	BR2-LM	5798	06	4740
12C600 Series Intek Single Cyl. OHV	0,50	BKR5E	7938	07	4803	190402 8hp	0,70	B2-LM	1147	06	4740
12C700 / 12C800 Series Single Cyl. "L" Head	0,70	BR2-LM	5798	06	4740	190700 / 191700 Single Cyl. "L" head 8hp	0,80	BR2-LM	5798	06	4740
12D000 Single Cyl. "L" head 4.75hp	0,80	BR2-LM	5798	06	4740	192400 Single Cyl. "L" head 8hp	0,80	BR2-LM	5798	06	4740
12D300 / 12D400 Series Intek Single Cyl. OHV	0,70	BKR5E	7938	07	4803	192700 / 193400 Series Single Cyl. "L" Head	0,70	BR2-LM	5798	06	4740
12D600 Series Intek Single Cyl. OHV	0,50	BKR5E	7938	07	4803	193700 / 194000 Single Cyl. "L" head 8hp	0,80	BR2-LM	5798	06	4740
12D800 Series Single Cyl. "L" Head	0,70	BR2-LM	5798	06	4740	194400 / 194700 Series Single Cyl. "L" Head	0,70	BR2-LM	5798	06	4740
12E000 Single Cyl. "L" head 4hp	0,80	BR2-LM	5798	06	4740	195000 Single Cyl. "L" head 8hp	0,80	BR2-LM	5798	06	4740
12E300 Series Intek Single Cyl. OHV	0,70	BKR5E	7938	07	4803	195400 / 195700 Series Single Cyl. "L" Head	0,70	BR2-LM	5798	06	4740
12E700 / 12E800 Series Single Cyl. "L" Head	0,70	BR2-LM	5798	06	4740	196400 Single Cyl. "L" head 8hp	0,80	BR2-LM	5798	06	4740
12F000 Single Cyl. "L" head 5hp	0,80	BR2-LM	5798	06	4740	196700 Single Cyl. "L" head 8.5hp	0,80	BR2-LM	5798	06	4740
12F600 Series Intek Single Cyl. OHV	0,50	BKR5E	7938	07	4803	196707 8.5 hp	0,70	BR2-LM	5798	06	4740
12F700 / 12F800 Series Single Cyl. "L" Head	0,70	BR2-LM	5798	06	4740	197400 Single Cyl. "L" head 8hp	0,80	BR2-LM	5798	06	4740
12G000 Single Cyl. "L" head 5hp	0,80	BR2-LM	5798	06	4740	197700 OHV 8.5 hp	0,70	BCPR5ES	6130	07	4803
12G600 Series Intek Single Cyl. OHV	0,50	BKR5E	7938	07	4803	197700 / 198700 Series Single Cyl. "L" Head	0,70	BR2-LM	5798	06	4740
12G700 / 12G800 Series Single Cyl. "L" Head	0,70	BR2-LM	5798	06	4740	19A400 / 19B400 serie Single Cyl. "L" head 9hp	0,70	BKR5ES	2460	07	4803
12H000 Single Cyl. "L" head 6hp	0,80	BR2-LM	5798	06	4740	19K400 Series Single Cyl. "L" Head	0,70	BR2-LM	5798	06	4740
12H600 Series Intek Single Cyl. OHV	0,50	BKR5E	7938	07	4803	200400 Single Cyl. "L" head 8hp	0,80	BR2-LM	5798	06	4740
12H700 / 12H800 Series Single Cyl. "L" Head	0,70	BR2-LM	5798	06	4740	201400 Series Intek Single Cyl. OHV	0,70	BKR5E	7938	07	4803
12J000 Single Cyl. "L" head 6hp	0,80	BR2-LM	5798	06	4740	202400 / 203400 Series Intek Single Cyl. OHV	0,70	BKR5E	7938	07	4803
12J700 Series Single Cyl. "L" Head	0,70	BR2-LM	5798	06	4740	204400 / 205400 Series Intek Single Cyl. OHV	0,70	BKR5E	7938	07	4803
12J800 / 12K800 Series Single Cyl. "L" Head	0,70	BR2-LM	5798	06	4740	206400 Series Intek Single Cyl. OHV	0,70	BKR5E	7938	07	4803
12L000 Single Cyl. "L" head 4.5hp	0,80	BR2-LM	5798	06	4740	207400 Series Single OHV	0,70	BKR5E	7938	07	4803
12L700 Series Single Cyl. "L" Head	0,70	BR2-LM	5798	06	4740	20A100 / 20A400 Series Intek Single Cyl. OHV	0,70	BKR5E	7938	07	4803
12M000 Single Cyl. "L" head 5.5hp	0,80	BR2-LM	5798	06	4740	20B400 / 20C400 Series Intek Single Cyl. OHV	0,70	BKR5E	7938	07	4803
12M800 / 12N800 Series Single Cyl. "L" Head	0,70	BR2-LM	5798	06	4740	20D400 / 20E100 Series Intek Single Cyl. OHV	0,70	BKR5E	7938	07	4803
12P800 / 12Q800 Series Single Cyl. "L" Head	0,70	BR2-LM	5798	06	4740	20E200 / 20E300 Series Intek Single Cyl. OHV	0,70	BKR5E	7938	07	4803
12R800 / 12S700 Series Single Cyl. "L" Head	0,70	BR2-LM	5798	06	4740	20E400 / 20F400 Series Intek Single Cyl. OHV	0,70	BKR5E	7938	07	4803
12S800 Series Single Cyl. "L" Head	0,70	BR2-LM	5798	06	4740	20G400 Series Intek Single Cyl. OHV	0,70	BKR5E	7938	07	4803
12T000 Single Cyl. "L" head 4hp	0,80	BR2-LM	5798	06	4740	21000 Series Single Cyl. "L" Head	0,60	BPMR6F	1270	-	-
12T700 / 12T800 Series Single Cyl. "L" Head	0,70	BR2-LM	5798	06	4740	210400 Series Single OHV	0,70	BKR5E	7938	07	4803
12U000 Single Cyl. "L" head 5hp	0,80	BR2-LM	5798	06	4740	210700 Series Intek Single Cyl. OHV	0,70	BKR5E	7938	07	4803

Modèle			N° STOCK	N° BLISTER	N° STOCK	Modèle			N° STOCK	N° BLISTER	N° STOCK
			BOÎTE	BLISTER	BLISTER				BOÎTE	BLISTER	BLISTER
BRIGGS & STRATTON - Générateurs											
210800 / 211700 Series Single OHV	0,70	BKR5E	7938	07	4803	28C700 Single Cyl. "L" head 11hp, 28C707 11hp	0,70	BR2-LM	5798	06	4740
21100 Series Single Cyl. "L" Head	0,60	BPMP6F	1270	-	-	28CH00 Series ELS-Extended Life Serie	0,70	BKR5E	7938	07	4803
211800 / 212400 Series Single OHV	0,70	BKR5E	7938	07	4803	28D700 Single Cyl. "L" head 11.5hp	0,70	BR2-LM	5798	06	4740
212700 / 212800 Series Single OHV	0,70	BKR5E	7938	07	4803	28D707 11.5hp	0,70	BR2-LM	5798	06	4740
212900 / 213400 Series Intek Single Cyl. OHV	0,70	BKR5E	7938	07	4803	28E700 Series Single OHV	0,70	BKR5E	7938	07	4803
213700 / 213800 Series Single OHV	0,70	BKR5E	7938	07	4803	28F700 / 28M700 Single Cyl. "L" head 13hp	0,70	BR2-LM	5798	06	4740
214700 / 214800 Series Single OHV	0,70	BKR5E	7938	07	4803	28M707 13hp	0,80	BR2-LM	5798	06	4740
214900 / 215900 Series Intek Single Cyl. OHV	0,70	BKR5E	7938	07	4803	28N700 serie Single Cyl. OHV 15.5hp	0,70	BCPR5ES	6130	07	4803
215700 / 215800 Series Single OHV	0,70	BKR5E	7938	07	4803	28N700 Series Single OHV	0,70	BKR5E	7938	07	4803
216700 / 216800 Series Single OHV	0,70	BKR5E	7938	07	4803	28N707 15hp	0,70	BCPR5ES	6130	07	4803
216900 / 219900 Series Intek Single Cyl. OHV	0,70	BKR5E	7938	07	4803	28P700 Series Vanguard Single Cyl. OHV	0,70	BKR5E	7938	07	4803
217700 / 217800 Series Single OHV	0,70	BKR5E	7938	07	4803	28P777 OHV 14hp, 28Q777 15.5hp	0,70	BCPR5ES	6130	07	4803
217900 / 218700 Series Intek Single Cyl. OHV	0,70	BKR5E	7938	07	4803	28Q700 Series Vanguard Single Cyl. OHV	0,70	BKR5E	7938	07	4803
218800 / 219700 / 219800 Series Single OHV	0,70	BKR5E	7938	07	4803	28Q777 OHV 16 hp	0,70	BCPR5ES	6130	07	4803
21A400 / 21A700 Series Intek Single Cyl. OHV	0,70	BKR5E	7938	07	4803	28R700 Single Cyl. "L" head 13.5hp	0,70	BR2-LM	5798	06	4740
21A800 / 21A900 Series Single OHV	0,70	BKR5E	7938	07	4803	28S700 Series Vanguard Single Cyl. OHV	0,70	BKR5E	7938	07	4803
21B700 / 21B800 Series Single OHV	0,70	BKR5E	7938	07	4803	28T700 Series Single Cyl. "L" Head	0,70	BR2-LM	5798	06	4740
21B900 Series Intek Single Cyl. OHV	0,70	BKR5E	7938	07	4803	28U700 Series Single OHV	0,70	BKR5E	7938	07	4803
21C100 / 21C200 Series Single OHV	0,70	BKR5E	7938	07	4803	28V700 Series Single Cyl. "L" Head	0,70	BR2-LM	5798	06	4740
220000 10hp	0,80	BR2-LM	5798	06	4740	28W700 Series Single OHV	0,70	BKR5E	7938	07	4803
220400 / 220700 Series Single Cyl. "L" Head 10hp	0,70	BR2-LM	5798	06	4740	290000 serie OHV 12.5hp, 294777 OHV 14hp	0,70	BCPR5ES	6130	07	4803
221400 Single Cyl. "L" head 10hp	0,80	BR2-LM	5798	06	4740	300000 serie OHV 15hp	0,70	BCPR5ES	6130	07	4803
221430 10hp	0,70	BR2-LM	5798	06	4740	300400 / 301400 Single Cyl. "L" head 12hp	0,70	BR2-LM	5798	06	4740
222400 / 226400 Single Cyl. "L" head 10hp	0,70	BR2-LM	5798	06	4740	302400 Single Cyl. "L" head 13hp	0,70	BR2-LM	5798	06	4740
230000 9hp	0,80	BR2-LM	5798	06	4740	302430 13hp	0,80	BR2-LM	5798	06	4740
231400 / 233400 Single Cyl. "L" head 9hp	0,80	BR2-LM	5798	06	4740	303400 16hp	0,70	BCPR5ES	6130	07	4803
235400 serie Single Cyl. OHV Vanguard 11hp	0,70	BCPR5ES	6130	07	4803	303400 Series Vanguard V-Twin OHC	0,70	BKR5E	7938	07	4803
235432 11hp	0,70	BCPR5ES	6130	07	4803	303777 OHV 16hp	0,70	BCPR5ES	6130	07	4803
240000 10hp	0,80	BR2-LM	5798	06	4740	304400 Series Vanguard V-Twin OHC	0,70	BKR5E	7938	07	4803
242400 10 hp	0,70	B2-LM	1147	06	4740	305700 B&S	0,70	BKR5E	2460	07	4803
243400 Single Cyl. "L" head 10hp	0,80	BR2-LM	5798	06	4740	30A400 Series Vanguard V-Twin OHC	0,70	BKR5E	7938	07	4803
243430 10hp	0,70	BR2-LM	5798	06	4740	310700 Series Intek Single Cyl. OHV	0,70	BKR5E	7938	07	4803
245400 Series Vanguard Single Cyl. OHV	0,70	BKR5E	7938	07	4803	310707 16.5hp	0,70	BCPR5ES	6130	07	4803
245432 14hp	0,70	BCP5ES	7496	07	4803	311700 / 312700 Series Intek Single Cyl. OHV	0,70	BKR5E	7938	07	4803
245437-0284	0,70	BKR5ES	2460	07	4803	312700 Series Vanguard Single Cyl. OHV	0,70	BKR5E	7938	07	4803
250000 11hp	0,80	BR2-LM	5798	06	4740	312777 17hp	0,70	BCPR5ES	6130	07	4803
250400 / 251400 Single Cyl. "L" head 11hp	0,70	BR2-LM	5798	06	4740	313700 / 319700 / 31A700 Series Single OHV	0,70	BKR5E	7938	07	4803
251700 / 252000 Single Cyl. "L" head 11hp	0,70	BR2-LM	5798	06	4740	314700 Series Intek Single Cyl. OHV	0,70	BKR5E	7938	07	4803
252400 / 252410 / 252412 / 252700 11hp	0,70	B2-LM	1147	06	4740	31B700 / 31C700 / 31D700 Series Single OHV	0,70	BKR5E	7938	07	4803
253000 Single Cyl. "L" head 11hp	0,70	BR2-LM	5798	06	4740	31E700 / 31F700 Series Intek Single Cyl. OHV	0,70	BKR5E	7938	07	4803
253400 / 253410 11hp	0,70	B2-LM	1147	06	4740	31G700 Series Single OHV	0,70	BKR5E	7938	07	4803
253700 10hp	0,70	BR2-LM	5798	06	4740	31H700 Series Intek Single Cyl. OHV	0,70	BKR5E	7938	07	4803
253700 11hp	0,70	B2-LM	1147	06	4740	31J700 / 31K700 Series ELS-Extended Life Serie	0,70	BKR5E	7938	07	4803
254400 / 255400 Single Cyl. "L" head 11hp	0,70	BR2-LM	5798	06	4740	31L700 / 31M700 Series ELS-Extended Life Serie	0,70	BKR5E	7938	07	4803
254700 / 255700 Single Cyl. "L" head 10hp	0,70	BR2-LM	5798	06	4740	320000 Series 16 hp	0,70	BR2-LM	5798	06	4740
256400 / 258700 Single Cyl. "L" head 11hp	0,70	BR2-LM	5798	06	4740	320400 Single Cyl. "L" head 14hp, 32400 Series	0,70	BR2-LM	5798	06	4740
256700 Single Cyl. "L" head 10hp	0,70	BR2-LM	5798	06	4740	3250 6.5 hp	0,70	BKR5E	7938	07	4803
257400 Series Single Cyl. "L" Head	0,70	BR2-LM	5798	06	4740	325400 Single Cyl. "L" head 15hp	0,70	BR2-LM	5798	06	4740
257700 Single Cyl. "L" head 10.5hp	0,70	BR2-LM	5798	06	4740	326430 16hp	0,70	BR6S	3522	09	6048
259700 Single Cyl. "L" head 11.5hp	0,70	BR2-LM	5798	06	4740	350000 18hp	0,70	BCPR5ES	6130	07	4803
260700 Series Vanguard Single Cyl. OHV 12.5hp	0,70	BKR5E	7938	07	4803	350777 OHV 18 hp, 351000 OHV 20hp	0,70	BCPR5ES	6130	07	4803
261700 Series Vanguard Single Cyl. OHV 14hp	0,70	BKR5E	7938	07	4803	351400 serie V-Twin OHV Vanguard 20hp	0,70	BKR5ES	2460	07	4803
280000 12hp, 280700 Single Cyl. "L" head 12hp	0,70	BR2-LM	5798	06	4740	351700 serie V-Twin OHV Vanguard 20hp	0,70	BKR5ES	2460	07	4803
280777 15.5hp	0,70	BCPR5ES	6130	07	4803	351777 OHV 20hp	0,70	BCPR5ES	6130	07	4803
280H00 Series Single OHV	0,70	BKR5E	7938	07	4803	352700 Series V-Twin OHV	0,70	BKR4E	4421	-	-
281700 Single Cyl. "L" head 12hp	0,70	BR2-LM	5798	06	4740	354400 / 355700 Series Vanguard V-Twin OHC	0,70	BKR5E	7938	07	4803
281H00 Series Single OHV	0,70	BKR5E	7938	07	4803	356400 Series Vanguard V-Twin OHC	0,70	BKR5E	7938	07	4803
282700 Single Cyl. "L" head 12hp, 282707 12hp	0,70	BR2-LM	5798	06	4740	356447-0123	1,00	BKR5ES	2460	07	4803
282H00 Series Single OHV	0,70	BKR5E	7938	07	4803	356447-0175	0,70	BKR5ES	2460	07	4803
283700 Single Cyl. "L" head 12hp	0,70	BR2-LM	5798	06	4740	356700 / 357700 Series Vanguard V-Twin OHC	0,70	BKR5E	7938	07	4803
283H00 Series Intek Single Cyl. OHV	0,70	BKR5E	7938	07	4803	358700 Series Vanguard V-Twin OHC	0,70	BKR5E	7938	07	4803
284700 Single Cyl. "L" head 12hp	0,70	BR2-LM	5798	06	4740	380440 22hp	0,70	BCPR5ES	6130	07	4803
284H00 Series Intek Single Cyl. OHV	0,70	BKR5E	7938	07	4803	385400 / 385700 Series Vanguard V-Twin OHC	0,70	BKR5E	7938	07	4803
285700 12hp, 285700 Single Cyl. "L" head 12.5hp	0,70	BR2-LM	5798	06	4740	385777-0126	0,70	BKR5ES	2460	07	4803
285H00 Series Intek Single Cyl. OHV	0,70	BKR5E	7938	07	4803	386400 / 386700 Series Vanguard V-Twin OHC	0,70	BKR5E	7938	07	4803
286700 Single Cyl. "L" head 12.5hp	0,70	BR2-LM	5798	06	4740	390777 23hp	0,70	BCPR5ES	6130	07	4803
286707 12.5hp	0,70	BR2-LM	5798	06	4740	400400 / 400700 opposed twin Cyl. "L" head 14hp	0,70	BR2-LM	5798	06	4740
286H00 Series Intek Single Cyl. OHV	0,70	BKR5E	7938	07	4803	400437 / 400707 14hp	0,70	BR6S	3522	09	6048
287700 Series Single OHV 14.5hp	0,70	BKR5E	7938	07	4803	401417 / 401707 / 402417 / 402431 / 402437 16hp	0,70	BR6S	3522	09	6048
288700 / 289700 Single Cyl. "L" head 12.5hp	0,70	BR2-LM	5798	06	4740	402500 Series 2 Cyl. OHV	0,70	BKR5E	7938	07	4803
289707 12.5hp, 28A707 10hp	0,70	BR2-LM	5798	06	4740	402700 opposed twin Cyl. "L" head 16hp	0,70	BR2-LM	5798	06	4740
28A700 Single Cyl. "L" head 10hp	0,70	BR2-LM	5798	06	4740	402707 16hp	0,70	BR6S	3522	09	6048
28AH00 Series ELS-Extended Life Serie	0,70	BKR5E	7938	07	4803	404700 opposed twin Cyl. "L" head 12.5hp	0,70	BR2-LM	5798	06	4740
28B700 Single Cyl. "L" head 10.5hp	0,70	BR2-LM	5798	06	4740	404707 12.5hp	0,70	BR6S	3522	09	6048
28B707 10.5 hp	0,70	BR2-LM	5798	06	4740	406500 Series Intek V-Twin OHV	0,70	BKR5E	7938	07	4803
28BH00 Series ELS-Extended Life Serie	0,70	BKR5E	7938	07	4803	406777 18hp, 406777 22hp	0,70	BCPR5ES	6130	07	4803
						407500 / 407600 Series 2 Cyl. OHV	0,70	BKR5E	7938	07	4803
						40A700 opposed twin Cyl. "L" head 16.5hp	0,70	BR2-LM	5798	06	4740

Modèle		N°			Modèle		N°			
		STOCK	BLISTER	BOÎTE			BOÎTE	BLISTER	BLISTER	
40F700 / 40G700 Series ELS-Extended Life Serie	0,70	BKR5E	7938	07	4803	0,70	BR2-LM	5798	06	4740
40H700 Series ELS-Extended Life Serie	0,70	BKR5E	7938	07	4803	0,70	BKR5E	7938	07	4803
421400 18hp	0,70	BR6S	3522	09	6048	0,70	BR2-LM	5798	06	4740
421400 opposed twin Cyl. "L" head 18hp	0,70	BR2-LM	5798	06	4740	0,70	BR2-LM	5798	06	4740
422431 18hp	0,70	BR6S	3522	09	6048	0,70	BR2-LM	5798	06	4740
422437 16hp	0,80	BR2-LM	5798	06	4740	0,70	B2-LM	1147	06	4740
422437 18hp	0,70	BR6S	3522	09	6048	0,70	BR2-LM	5798	06	4740
422447 / 422707 16hp, 422447 18hp	0,80	BR2-LM	5798	06	4740	0,70	BR2-LM	5798	06	4740
422707 18hp	0,70	BR6S	3522	09	6048	0,70	BR2-LM	5798	06	4740
422707 20hp	0,80	BR2-LM	5798	06	4740	0,70	BR2-LM	5798	06	4740
42A700 Series Opposed Twin Cyl."L" Head	0,70	BR2-LM	5798	06	4740	0,70	BR2-LM	5798	06	4740
42B700 opposed twin Cyl. "L" head 16hp	0,70	BR2-LM	5798	06	4740	0,70	BR2-LM	5798	06	4740
42C700 opposed twin Cyl. "L" head 17hp	0,70	BR2-LM	5798	06	4740	0,70	BR2-LM	5798	06	4740
42D700 opposed twin Cyl. "L" head 18.5hp	0,70	BR2-LM	5798	06	4740	0,70	BR2-LM	5798	06	4740
42E700 opposed twin Cyl. "L" head 19.5hp	0,70	BR2-LM	5798	06	4740	0,70	BR2-LM	5798	06	4740
430400 Ser. DM700G Vanguard Refr. Liquide 3 Cyl	0,70	BKR5E	7938	07	4803	0,70	BCPR5ES	6130	07	4803
431400 / 432400 Series Vanguard Refr. Liq. 3 Cyl.	0,70	BKR5E	7938	07	4803	0,70	BKR5ES	2460	07	4803
433400 / 434400 Series Vanguard Refr. Liq. 3 Cyl.	0,70	BKR5E	7938	07	4803	0,70	BR2-LM	5798	06	4740
435400 / 436400 Series Vanguard Refr. Liq. 3 Cyl.	0,70	BKR5E	7938	07	4803	0,70	BR2-LM	5798	06	4740
437400 Series Vanguard Refr. Liq. 3 Cyl.	0,70	BKR5E	7938	07	4803	0,70	BR2-LM	5798	06	4740
445700 Series Intek V-Twin OHV	0,70	BKR5E	7938	07	4803	0,70	BR2-LM	5798	06	4740
446600 / 446700 Series ELS-Extended Life Serie	0,70	BKR5E	7938	07	4803	0,70	BKR5E	7938	07	4803
446800 / 446900 Series ELS-Extended Life Serie	0,70	BKR5E	7938	07	4803	0,70	BR2-LM	5798	06	4740
460700 opposed twin Cyl. "L" head 20hp	0,70	BR2-LM	5798	06	4740	0,80	BR2-LM	5798	06	4740
461700 opposed twin Cyl. "L" head 20.5hp	0,70	BR2-LM	5798	06	4740	0,70	BP6HS	4511	-	-
462700 / 463700 Series Oppos. Twin Cyl."L" Head	0,70	BR2-LM	5798	06	4740	0,80	BR2-LM	5798	06	4740
473100 Series Vanguard Refr. Liquide 3 Cyl	0,70	BKR5E	7938	07	4803	0,70	BR2-LM	5798	06	4740
474100 Series Vanguard V-Twin OHC	0,70	BKR5E	7938	07	4803	0,70	BR2-LM	5798	06	4740
48A700 Series Opposed Twin Cyl."L" Head	0,70	BR2-LM	5798	06	4740	0,70	AB-6	2910	-	-
5000 10hp	0,60	B2-LM	1147	06	4740	0,70	BR2-LM	5798	06	4740
5000 Series Vanguard Single Cyl. OHV	0,70	BPR6HS	7022	-	-	0,70	BCPR5ES	6130	07	4803
50000 Series Single OHV	0,70	BKR5E	7938	07	4803	0,80	BCPR5ES	6130	07	4803
522400 Series Vanguard Refr. Liquide 3 Cyl	0,70	BKR5E	7938	07	4803	0,70	BCPR5ES	6130	07	4803
541400 / 543400 Series Vanguard V-Twin OHC	0,70	BKR5E	7938	07	4803	0,70	BCPR5ES	6130	07	4803
542400 / 543200 Series Vanguard V-Twin OHC	0,50	BKR5E	7938	07	4803	0,70	BKR5ES	2460	07	4803
5500 10hp	0,60	B2-LM	1147	06	4740	0,70	BKR5E	7938	07	4803
580400 Ser. DM950G Vanguard Refr. Liquide 3 Cyl	0,70	BKR5E	7938	07	4803	0,70	BR2-LM	5798	06	4740
581400 / 582400 Series Vanguard Refr. Liq. 3 Cyl.	0,70	BKR5E	7938	07	4803	0,70	BR2-LM	5798	06	4740
583400 / 584400 Series Vanguard Refr. Liq. 3 Cyl.	0,70	BKR5E	7938	07	4803	0,70	BR2-LM	5798	06	4740
585400 / 586400 Series Vanguard Refr. Liq. 3 Cyl.	0,70	BKR5E	7938	07	4803	0,70	BR2-LM	5798	06	4740
587400 / 588400 Series Vanguard Refr. Liq. 3 Cyl.	0,70	BKR5E	7938	07	4803	0,70	BR2-LM	5798	06	4740
589400 / 58A400 Series Vanguard Refr. Liq. 3 Cyl.	0,70	BKR5E	7938	07	4803	0,70	BR2-LM	5798	06	4740
60000 serie 2hp	0,70	BR2-LM	5798	06	4740	0,70	BR2-LM	5798	06	4740
60100 Single Cyl. "L" head 2hp, 60102 2hp	0,70	BR2-LM	5798	06	4740	0,70	BR2-LM	5798	06	4740
613100 Series Vanguard V-Twin OHC	0,70	BKR5E	7938	07	4803	0,70	BR2-LM	5798	06	4740
613400 Series Vanguard Refr. Liquide 3 Cyl	0,70	BKR5E	7938	07	4803	0,70	BR2-LM	5798	06	4740
62000 2 cycle Engs. Single Cyl. 3hp	0,70	BR2-LM	5798	06	4740	0,70	BR2-LM	5798	06	4740
62000 / 62032 3 hp, 69000 2hp	0,70	BR2-LM	5798	06	4740	0,70	BR2-LM	5798	06	4740
7000 15 hp	0,70	BKR5E	7938	07	4803	0,70	BR2-LM	5798	06	4740
80000 / 80200 serie Single Cyl. "L" head 3hp	0,70	BR2-LM	5798	06	4740	0,70	BR2-LM	5798	06	4740
80100 Series Single Cyl. "L" Head 2.5 hp	0,70	BR2-LM	5798	06	4740	0,70	BR2-LM	5798	06	4740
80202 / 81200 / 81300 / 82000 3hp	0,70	BR2-LM	5798	06	4740	0,70	BR2-LM	5798	06	4740
80300 Series Single Cyl. "L" Head 3hp	0,70	BR2-LM	5798	06	4740	0,70	BR2-LM	5798	06	4740
80400 / 82200 / 82300 Series Single Cyl. "L" Head	0,70	BR2-LM	5798	06	4740	0,70	BR2-LM	5798	06	4740
82400 / 82500 / 82900 Series Single Cyl. "L" Head	0,70	BR2-LM	5798	06	4740	0,70	BR2-LM	5798	06	4740
83400 / 84500 / 84700 Series Single Cyl. "L" Head	0,70	BR2-LM	5798	06	4740	0,70	BR2-LM	5798	06	4740
84900 Series Single Cyl. "L" Head	0,70	BR2-LM	5798	06	4740	0,70	BR2-LM	5798	06	4740
85400 Series Vanguard Single Cyl. OHV	0,70	BKR5E	7938	07	4803	0,70	BR2-LM	5798	06	4740
854000 4hp	0,70	BCPR5ES	6130	07	4803	0,70	BR2-LM	5798	06	4740
854400 serie Single Cyl. OHV Vanguard 4hp	0,70	BCPR5ES	6130	07	4803	0,70	BR2-LM	5798	06	4740
85500 / 85900 Series Single Cyl. "L" Head	0,70	BR2-LM	5798	06	4740	0,70	BR2-LM	5798	06	4740
86400 Series Vanguard Single Cyl. OHV	0,70	BKR5E	7938	07	4803	0,70	BR2-LM	5798	06	4740
90000 / 90200 / 91000 serie 3.5hp	0,70	BR2-LM	5798	06	4740	0,70	BR2-LM	5798	06	4740
90100 / 90200 Single Cyl. "L" head 3hp	0,70	BR2-LM	5798	06	4740	0,70	BR2-LM	5798	06	4740
90400 Series Single Cyl. "L" Head	0,70	BR2-LM	5798	06	4740	0,70	BR2-LM	5798	06	4740
90700 / 91200 Single Cyl. "L" head 3.5hp	0,70	BR2-LM	5798	06	4740	0,70	BR2-LM	5798	06	4740
91200 Single Cyl. "L" head 3.5hp	0,70	BR2-LM	5798	06	4740	0,70	BR2-LM	5798	06	4740
91212 B&S	0,70	BPR6ES	7822	04	7678	0,70	BR2-LM	5798	06	4740
91400 series Single Cyl. "L" Head	0,70	BR2-LM	5798	06	4740	0,70	BR2-LM	5798	06	4740
91700 / 92200 Single Cyl. "L" head 3.5hp	0,70	BR2-LM	5798	06	4740	0,70	BR2-LM	5798	06	4740
92000 / 93232 / 93400 serie 3.5hp	0,70	BR2-LM	5798	06	4740	0,70	BR2-LM	5798	06	4740
92400 Series Single Cyl. "L" Head	0,70	BR2-LM	5798	06	4740	0,70	BR2-LM	5798	06	4740
92500 Single Cyl. "L" head 3hp	0,70	BR2-LM	5798	06	4740	0,70	BR2-LM	5798	06	4740
92900 / 93200 Single Cyl. "L" head 3.5hp	0,70	BR2-LM	5798	06	4740	0,70	BKR5ES	2460	07	4803
93400 w/Top Single Cyl. "L" head 3.5hp	0,70	BKR5ES	2460	07	4803	0,70	BCPR5ES	6130	07	4803
93401 3.5hp	0,70	BCPR5ES	6130	07	4803	0,70	BR2-LM	5798	06	4740
93440 w/No Tank Single Cyl. "L" head 3.5hp	0,70	BR2-LM	5798	06	4740	0,70	BR2-LM	5798	06	4740
93500 Series Single Cyl. "L" Head 3.5hp	0,70	BR2-LM	5798	06	4740	0,70	BR2-LM	5798	06	4740
93900 Single Cyl. "L" head 3.5hp	0,70	BR2-LM	5798	06	4740	0,70	BR2-LM	5798	06	4740
94200 Series Single Cyl. "L" Head	0,70	BKR5E	7938	07	4803	0,70	BR2-LM	5798	06	4740
94500 Single Cyl. "L" head 3hp	0,70	BR2-LM	5798	06	4740	0,70	BR2-LM	5798	06	4740
94900 Series Single Cyl. "L" Head 3.5hp	0,70	BR2-LM	5798	06	4740	0,70	BR2-LM	5798	06	4740
95000 serie 4hp	0,70	BR2-LM	5798	06	4740	0,70	BR2-LM	5798	06	4740
95100 / 95700 / 96700 / 96799 4hp	0,70	B2-LM	1147	06	4740	0,70	BR2-LM	5798	06	4740
95200 Series Single Cyl. "L" Head	0,70	BR2-LM	5798	06	4740	0,70	BR2-LM	5798	06	4740
95500 Series Single Cyl. "L" Head 3.5hp	0,70	BR2-LM	5798	06	4740	0,70	BR2-LM	5798	06	4740
95700 serie 2 tps Single Cyl. 5hp	0,70	BR2-LM	5798	06	4740	0,70	BR2-LM	5798	06	4740
95900 4hp, 96000 serie 4hp	0,70	BR2-LM	5798	06	4740	0,70	BR2-LM	5798	06	4740
95900 / 96500 Single Cyl. "L" head 3.5hp	0,70	BR2-LM	5798	06	4740	0,70	BR2-LM	5798	06	4740
96700 serie 2 tps Single Cyl. 5hp	0,70	BR2-LM	5798	06	4740	0,70	BR2-LM	5798	06	4740
96900 / 98900 / 99700 4hp	0,70	BR2-LM	5798	06	4740	0,70	BR2-LM	5798	06	4740
96900 / 98900 Single Cyl. "L" head 3.75hp	0,70	BR2-LM	5798	06	4740	0,70	BR2-LM	5798	06	4740
97700 6 hp	0,70	BCPR5ES	6130	07	4803	0,70	BR2-LM	5798	06	4740
99700 serie Single Cyl. OHV 6hp	0,70	BKR5ES	2460	07	4803	0,70	BR2-LM	5798	06	4740
9B900 / 9E900 Series Single Cyl. "L" Head	0,70	BR2-LM	5798	06	4740	0,70	BR2-LM	5798	06	4740
9C900 / 9D900 Single Cyl. "L" head 3.8hp	0,70	BR2-LM	5798	06	4740	0,70	BR2-LM	5798	06	4740
9F900 / 9G900 Series Single Cyl. "L" Head	0,70	BR2-LM	5798	06	4740	0,70	BR2-LM	5798	06	4740
9H900 / 9J900 Series Single Cyl. "L" Head	0,70	BR2-LM	5798	06	4740	0,70	BR2-LM	5798	06	4740
9K400 Series Single Cyl. "L" Head	0,70	BKR5E	7938	07	4803	0,70	BR2-LM	5798	06	4740
9K900 Series Single Cyl. "L" Head	0,70	BR2-LM	5798	06	4740	0,70	BR2-LM	5798	06	4740
Autres modèles culasse Ø14mm	0,80	BR2-LM	5798	06	4740	0,70	BR2-LM	5798	06	4740
BSQ 1000	0,70	BP6HS	4511	-	-	0,70	BR2-LM	5798	06	4740
Classic	0,80	BR2-LM	5798	06	4740	0,70	BR2-LM	5798	06	4740
Classic 95902	0,70	BR2-LM	5798	06	4740	0,70	BR2-LM	5798	06	4740
Culasse Ø18 mm	0,70	AB-6	2910	-	-	0,70	BR2-LM	5798	06	4740
Diamond XTL, Diamond XTS 60 12J802, ES 375	0,70	BR2-LM	5798	06	4740	0,70	BR2-LM	5798	06	4740
Europa 99772 OHV	0,70	BCPR5ES	6130	07	4803	0,70	BR2-LM	5798	06	4740
Intek OHV	0,80	BCPR5ES	6130	07	4803					

Modèle

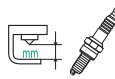
 N° STOCK BLISTER
 N° BOÎTE
 N° BLISTER

BUNTON - Débroussailleuses

Mot. 5 hp B&S, Mot. 8 hp B&S	0,60	B2-LM	1147	06	4740
Mot. Clinton	0,80	BR6S	3522	09	6048
Mot. Robin	0,80	B6HS	4510	-	-
Mot. Tecumseh	0,80	BM6A	5921	01	5478

BUNTON - Tondeuses

Estate Pro - Mot. B&S 17.5 hp	0,80	BKR5E	7938	07	4803
Estate Pro - Mot. B&S Intek V-Twin 18.25 hp	0,80	BKR5E	7938	07	4803
Mot. B&S 3 Cyl. (Ref. Liquide) 31 hp	0,80	BKR5E	7938	07	4803
Mot. B&S 5 / 8 hp	0,70	BR2-LM	5798	06	4740
Mot. B&S 14 hp, Mot. B&S 16 hp	0,70	BKR5ES	2460	07	4803
Mot. B&S ELS 17.5 hp	0,70	BKR5ES	2460	07	4803
Mot. B&S Intek 6.5 / 18 hp	0,80	BKR5E	7938	07	4803
Mot. B&S Intek V-Twin 18 hp / 25 hp	0,70	BKR5ES	2460	07	4803
Mot. Honda	0,60	BM6A	5921	01	5478
Mot. Honda OHV 11 / 13 hp	0,80	BPR5ES	7422	03	6854
Mot. Kawa. V-Twin (Ref. Liq) 14.5 / 18 / 20 hp	0,80	BMR6A	7421	01	5478
Mot. Kawasaki 20 hp	0,60	BMR4A	5728	-	-
Mot. Kawasaki OHV 12.5	0,80	BPR5ES	7422	03	6854
Mot. Kawasaki V-Twin 15 / 17 hp	0,80	BMR6A	7421	01	5478
Mot. Kawasaki V-Twin 19 / 21 / 25 hp	0,80	BPR5ES	7422	03	6854
Mot. Kawasaki V-Twin OHV 15 hp	0,60	BCPR6ES	2330	-	-
Mot. Kawasaki V-Twin OHV 17 hp	0,60	BPMR6A	6726	08	5063
Mot. Kawasaki V-Twin OHV 19 hp	0,60	BCPR6ES	2330	-	-
Mot. Kawasaki V-Twin OHV 21 / 23 / 25 hp	0,70	BPR4ES	7222	-	-
Mot. Kohler 14 / 18 / 20 / 25 hp	0,70	BKR5ES	2460	07	4803
Mot. Kohler AEGIS OHV 23 hp	0,70	BKR5ES	2460	07	4803
Mot. Kohler OHV 12.5 / 14 / 15 hp	0,80	BKR5E	7938	07	4803
Mot. Kohler OHV Command Pro V-Twin 26 hp	0,70	BKR5ES	2460	07	4803
Mot. Kohler OHV EFI 26 hp	0,80	BKR5E	7938	07	4803
Mot. Kohler V-Twin 17 / 18 / 20 / 22 / 25 hp	0,80	BKR5E	7938	07	4803
Mot. Onan Twin 18 / 20 hp	0,80	TR4	3754	-	-
Mot. Robin	0,70	BR6HS	3922	-	-

BUSH HOG - Tondeuses

CZ2149 Mot. Kawasaki FH641V 21 hp	0,70	BPR4ES	7222	-	-
CZ2349 / CZ2355 - Kohler Comm. Pro CV23S 23hp	0,70	BKR5ES	2460	07	4803
CZ2555 / CZ2561 Mot. Kawasaki FH721V 25 hp	0,70	BPR4ES	7222	-	-
CZ2561 Mot. Kohler Comm. Pro CV730 25 hp	0,70	BKR5ES	2460	07	4803
EC2555KH2 Mot. Kohler Cour. Pro SV830 25hp	0,70	BKR5ES	2460	07	4803
EC2561KH2 Mot. Kohler Cour. Pro SV830 25hp	0,70	BKR5ES	2460	07	4803
EC2761KH2 Mot. Kohler Cour. Pro SV840 27hp	0,70	BKR5ES	2460	07	4803
ES1744B Mot. B&S Intek OHV 17.5 hp	0,70	BKR5ES	2460	07	4803
ES2044KH4 Mot. Kohler Cour. SV710S 20hp	0,70	BKR5ES	2460	07	4803
ES2052H Honda GXV620 OHV V-Twin 20 hp	0,80	BPR5ES	7422	03	6854
ES2052KH4 Mot. Kohler Cour. SV710S 20hp	0,70	BKR5ES	2460	07	4803
ES2344B / ES2352B Mot. B&S ELS V-Twin 23 hp	0,70	BKR5ES	2460	07	4803
ES2352KH4 Kohler Courage Pro SV820S 23hp	0,70	BKR5ES	2460	07	4803
ES2552KH4 Mot. Kohler Cour. Pro SV830 25hp	0,70	BKR5ES	2460	07	4803
HS1736B / HS1742B Mot. B&S Intek OHV 17.5 hp	0,70	BKR5ES	2460	07	4803
HS1836B / HS1842B Mot. B&S Intek V-Twin 18 hp	0,70	BKR5ES	2460	07	4803
HS2042K Kohler Cour. SV710 V-Twin 20hp	0,70	BKR5ES	2460	07	4803
PZ2555K / PZ2561 Mot. Kawasaki FH721V 25 hp	0,70	BPR4ES	7222	-	-
PZ2755 Mot. Kohler Com. Pro CV740 27hp	0,70	BKR5ES	2460	07	4803
PZ2761KH3 Mot. Kohler Com. Pro CV740 27hp	0,70	BKR5ES	2460	07	4803
PZ3061KH3 Mot. Kohler Com. Pro CV750 30hp	0,70	BKR5ES	2460	07	4803
PZ3073KH3 Mot. Kohler Com. Pro CV750 30hp	0,70	BKR5ES	2460	07	4803
RS2650B Mot. B&S Professional Series 26 hp	0,70	BKR5ES	2460	07	4803

CAJUN - Tondeuses

Mot. B&S Intek 6.5 / 6.75 / 8 hp	0,80	BKR5E	7938	07	4803
----------------------------------	------	--------------	-------------	-----------	-------------

CAMPBELL-HAUSFELD - Générateurs

Mot. B&S 5 / 8 / 10 / 11 hp	0,60	B2-LM	1147	06	4740
Mot. B&S Intek 6 hp	0,70	BKR5E	7938	07	4803
Mot. B&S Vanguard V-Twin 16 / 18 / 20 hp	0,70	BKR5E	7938	07	4803
Mot. Honda GX160 5.5 hp	0,60	B2-LM	1147	06	4740
Mot. Honda OHV 13 hp	0,70	BP5ES	6511	03	6854

CAMPBELL-HAUSFELD - Tronçonneuses

2000 / 3000 / 3001 / 3002 / 3003	0,80	BMR6F	2144	11	7683
----------------------------------	------	--------------	-------------	-----------	-------------

Modèle

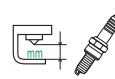
 N° STOCK BLISTER
 N° BOÎTE
 N° BLISTER

CANADIANA - Outils Divers

CL 61750 R Mot. B&S 750 Snow Series OHV	0,90	BCPR5ES	6130	07	4803
CL 61900 R Mot. B&S 900 Snow Series OHV	0,90	BCPR5ES	6130	07	4803
CL 841650 S Mot. B&S 1650 Snow Series OHV	0,90	BCPR5ES	6130	07	4803
CM 691150 E Mot. B&S 1150 Snow Series OHV	0,90	BCPR5ES	6130	07	4803
CM 741450 HE Mot. B&S 1450 Snow Series OHV	0,90	BCPR5ES	6130	07	4803
CS 55800 E Mot. B&S 800 Snow Series OHV	0,90	BCPR5ES	6130	07	4803

CANYCOM - Tondeuses

Mot. B&S Vanguard V-Twin 21 hp	0,80	BKR5E	7938	07	4803
Mot. Kawasaki 23 hp	0,80	BPR5ES	7422	03	6854

CARGILE - Tondeuses

Mot. Tecumseh 5.5 hp	0,70	BR2-LM	5798	06	4740
----------------------	------	---------------	-------------	-----------	-------------

CASAL - Tondeuses

M 112, M 113	1,00	BZ7HS-10	3579	-	-
M 131, M 132, M 136, M 137, M 140, M 147	0,70	BR6HS	3922	-	-
M 148, M 149, M 196, M 197, M 151, 153	0,70	BR6HS	3922	-	-
M 233, 234	0,70	BR9ES	5722	-	-

CASE - Générateurs

77, 80, 88, 130, 133, 135, 140, 159G, 160, 177	0,60	AB-6	2910	-	-
188G, 200, 220, 230, 301G, 310, 320, 330T, 330W	0,60	AB-6	2910	-	-
377G, 420, 430, 431, 435, 440, 441, 445, 470, 500	0,60	AB-6	2910	-	-
500LK, 520, 530, 531, 540, 541, 545, 570	0,60	AB-6	2910	-	-
600, 620, 660, 680, 610	0,60	AB-6	2910	-	-
700, 900, 960 Chry.Eng.H225	0,60	B6ES	7310	-	-
730, 731, 732, 733, 734, 740, 741, 742, 743	0,60	AB-6	2910	-	-
744, 770, 800, 830, 831, 832, 833, 840, 841	0,60	AB-6	2910	-	-
843, 870, 910, 930, 970	0,60	AB-6	2910	-	-
1000 Herc.Engs.	0,60	B6S	3510	09	6048
1000, 1010 Case Engs.	0,60	AB-6	2910	-	-
1010, 1060, 1160 Chry.Eng.HB318 3/8"	0,60	BP6S	3111	-	-
1060, 1160, 1660 Chry.Eng.LH318 3/4"	0,60	BP5ES	6511	03	6854
1530, 1537	0,60	AB-6	2910	-	-
1665 Chry.Eng.3/8"Reach	0,60	BP6S	3111	-	-
5350	0,60	AB-6	2910	-	-
A-284, A-377	0,60	AB-6	2910	-	-
Cl, DI, GT, LAI, LI, RI, VAI, VI	0,60	AB-6	2910	-	-
Forage Harvesters C2, 200	0,60	AB-6	2910	-	-
LI, SI, VI	0,60	B6S	3510	09	6048
M3, MB3, W3, W5, W7, W8	0,60	AB-6	2910	-	-
NAP-2, NAP-3	0,60	B6S	3510	09	6048
NC, NCM, NL, NT, MT	0,60	AB-6	2910	-	-
W8B, W9, W9A, W9B, W10B, W10 Terraloader	0,60	AB-6	2910	-	-
Windrowers : 650, 655, 820, 855, 950	0,60	AB-6	2910	-	-
Windrowers : 1050, 1140, 1150, 1155	0,60	AB-6	2910	-	-

CASE - Manutention

210, 310, 320, 420, 430, 500, 500LK, 520 - Ø18mm	0,60	AB-6	2910	-	-
530, 600, 620, 680, 800, 1530, 1537 - Ø18mm	0,60	AB-6	2910	-	-
1818 - Ø14mm	0,60	TR5	2238	-	-
1825 - Ø14mm, 1835C - Mot. Nissan A12 25 hp	0,60	B5ES	6410	-	-
1835C - Ø14mm	0,70	BPR4ES	7222	-	-
1835C - Ø18mm	0,60	AB-6	2910	-	-
1835C Mot. Onan Twin 18 hp	0,60	TR5	2238	-	-
Cl, DI, LAI, LI - Ø18mm	0,60	AB-6	2910	-	-
LI, RI, SI, VI - Ø14mm	0,60	B6S	3510	09	6048
M3, MB3 - Ø18mm	0,60	AB-6	2910	-	-
Teledyne Mot. TM20 48 hp	0,70	BPR4ES	7222	-	-
VAI, VI, W3, 5, 7, 8/8B, 9/A/B, 10B - Ø18mm	0,60	AB-6	2910	-	-
W10 Terraloader - Ø18mm	0,60	AB-6	2910	-	-

CASE - Tondeuses

Tous modèles	0,70	BR2-LM	5798	06	4740
--------------	------	---------------	-------------	-----------	-------------

CASEY MOW - Tondeuses

Tous modèles	0,70	BR2-LM	5798	06	4740
--------------	------	---------------	-------------	-----------	-------------

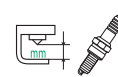
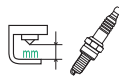

CASTEL GARDEN - Tondeuses

Mot. B&S 3.5 / 3.75 / 5 / 5.5 / 12.5 / 15 / 16 hp	0,70	BR2-LM	5798	06	4740
Mot. B&S V-Twin Vanguard 16 / 18 hp	0,90	BKR5E	7938	07	4803
Mot. Honda 5 hp	0,80	BPR6ES	7822	04	7678
Mot. Tecumseh 3.5 / 3.8 / 4 / 4.5 / 5 hp	0,70	BR6S	3522	09	6048

CASTOR - Tronçonneuses

C-35, C-40, C40E, C-70, C-70S, C-90	0,50	BPM7A	7321	02	5959
CP-55, CP-65	0,50	BPMR7A	4626	02	5959
CP-90, CP-120, Tropical 120	0,50	BPM7A	7321	02	5959

CATERPILLAR - Générateurs

800G, D1300 (Special), 13000 (Gas conversion)	0,60	B6S	3510	09	6048
824, 834, D2, D4	0,60	AB-6	2910	-	-
824, 834, D2, D4	0,70	BP-4	2911	-	-
1404w / Mot. Hercules G1600	0,60	B6S	3510	09	6048
Culasse de 14 mm	0,80	BR6S	3522	09	6048
D4C, D6B	0,60	BP5S	3011	-	-
D6, D7, D8, D9, RD4 - Ø 14 mm	0,70	BP-4	2911	-	-
D6, D7, D8, D9, RD4 - Ø 18 mm	0,60	AB-6	2910	-	-
D311 / D315 / D318 / D320 / D326 - Ø 14 mm	0,70	BP-4	2911	-	-
D311 / D315 / D318 - Ø 18 mm	0,60	AB-6	2910	-	-
D318 (Special)	0,60	BM6A	5921	01	5478
D320 / D326 / D337 - Ø 18 mm	0,60	AB-6	2910	-	-
D330 / D333	0,70	BP5S	3011	-	-
D337 / D339 / D342	0,70	BP-4	2911	-	-
D339 / D342 / D343 - Ø 18 mm	0,60	AB-6	2910	-	-
D343 / D353 / D375	0,70	BP-4	2911	-	-
D353 / D375 / D379 - Ø 18 mm	0,60	AB-6	2910	-	-
D379 / D397 / D398 - Ø 14 mm	0,70	BP-4	2911	-	-
D397 / D398 / D3400 / D4400 / D4600 - Ø 18 mm	0,60	AB-6	2910	-	-
D3400 / 4400 / D4600 - Ø 14 mm	0,70	BP-4	2911	-	-
D6600/7700/8800/11000/13000/17000-Ø14mm	0,70	BP-4	2911	-	-
D6600/7700/8800/11000/13000/17000-Ø18mm	0,60	AB-6	2910	-	-
DW10, DW15, DW20, DW21	0,60	AB-6	2910	-	-
DW15, DW20, DW21	0,70	BP-4	2911	-	-
T30B, T35B, T40B, T45B, T50B, T55B, T60B	0,90	BP5S	3011	-	-
V30C, V35C, V40C, V45C, V50C	0,90	BP5S	3011	-	-

CATERPILLAR - Manutention

1404 Mot. Hercules G1600	0,60	B6S	3510	09	6048
824, 834 - Ø14mm	0,80	XR4	5858	-	-
824, 834 - Ø18mm	0,60	AB-6	2910	-	-
D2 / 4 / 6 / 7 / 8 / 9 - Ø14mm	0,80	XR4	5858	-	-
D2 / 4 / 6 / 7 / 8 / 9 - Ø18mm	0,60	AB-6	2910	-	-
D4C, D6B	0,80	XR5	3332	-	-
DW10 / 15 / 20 / 21 - Ø18mm	0,60	AB-6	2910	-	-
DW15 / 20 / 21, RD4 - Ø14mm	0,80	XR4	5858	-	-
RD4, F163, F227 - Ø18mm	0,60	AB-6	2910	-	-
T 30B, 35B, 40B, 45B, 50B, 55B, 60B	0,90	XR5	3332	-	-
T30D - Mot. Peugeot	0,60	BP5ES	6511	03	6854
V30C / 35C / 40C / 45C / 50C	0,90	XR5	3332	-	-
V80E 6.5 AMP	0,70	BPR4ES	7222	-	-

CENTAUR - Tondeuses

Culasse Ø18mm	0,60	AB-6	2910	-	-
---------------	------	-------------	-------------	---	---

CENTRAL PARK - Tondeuses

Mot. B&S	0,70	BR2-LM	5798	06	4740
Mot. B&S Twin Vanguard	0,90	BKR5E	7938	07	4803

CHAIN TRED - Tondeuses

Culasse Ø14 mm	0,70	BR6S	3522	09	6048
Culasse Ø18 mm	0,60	AB-6	2910	-	-

CHAMP - Manutention

Chrysler	0,60	B6S	3510	09	6048
Chrysler GPL	0,60	BR6S	3522	09	6048
Continental	0,60	AB-6	2910	-	-
Mot. Perkins F4-236	0,60	BP5ES	6511	03	6854

CHAMPION - Tondeuses

Mot. B&S	0,70	BR2-LM	5798	06	4740
----------	------	---------------	-------------	-----------	-------------

CHIEF - Tondeuses

Tous modèles	0,70	BR6S	3522	09	6048
--------------	------	-------------	-------------	-----------	-------------

CHIEF - Tronçonneuses

D15 / E75 / E95	0,80	BMR6A	7421	01	5478
D35	0,80	BR6S	3522	09	6048

CHIEFTAIN - Tondeuses

Mot. B&S	0,70	BR2-LM	5798	06	4740
----------	------	---------------	-------------	-----------	-------------

CHOREMASTER - Tondeuses

Tous modèles	0,70	BR2-LM	5798	06	4740
--------------	------	---------------	-------------	-----------	-------------

CHRYSLER POWER BEE - Générateurs

2 hp - 50056	0,80	BM6A	5921	01	5478
3 hp - 51001	0,80	B6S	3510	09	6048
3 hp - 51005, 51007, 51009, 51011	1,00	B-4	3210	-	-
3.3 hp - 50052, 50054	0,80	BM6A	5921	01	5478
4 hp - 58011	0,80	B-6L	3212	-	-
4 hp - 58021, 58037	0,80	B6S	3510	09	6048
4 hp - 58023, 58029, 58031, 58033, 58035	1,00	B-4	3210	-	-
4 hp - 58039, 58041, 58043, 58045	1,00	B-4	3210	-	-
4 hp - 58047, 58049, 58051, 58053	1,00	B-4	3210	-	-
4.25 hp - 50000, 50002, 50004, 50006	1,00	B-4	3210	-	-
4.25 hp - 50012, 50014	1,00	B-4	3210	-	-
4.7 hp - 61010	0,80	B6HS	4510	-	-
5 hp - 70019, 70033, 70037, 70039, 70041	1,00	B-4	3210	-	-
5.5 hp - 61005, 61006	0,80	B6HS	4510	-	-
6.2 hp - 82005, 82006, 82009, 82017	0,80	B6HS	4510	-	-
6.2 hp - 82019, 82021, 82023	0,80	B6HS	4510	-	-
6.5 hp - 82008, 82010	0,80	B6HS	4510	-	-
6.7 hp - 82007, 82011, 82029, 82031	0,80	B6HS	4510	-	-
7 hp - 82003, 82026, 82027	0,80	B6HS	4510	-	-
7 hp - 82030	0,80	B5HS	4210	-	-
7 hp - 82032, 82033, 82034, 82036	0,80	B6HS	4510	-	-
7.5 hp - 61001, 61002	0,80	B6HS	4510	-	-
8 hp - 61012	0,80	B6HS	4510	-	-
10 hp - 82001, 82002, 82038, 82039	0,80	B6HS	4510	-	-

CHUNG YANG - Générateurs

CY 23RC / 26RC / 27RC / 29RC	0,70	CMR7H	3066	-	-
GP 290 / 420 / 460	0,70	CMR7H	3066	-	-

CIFARELLI - Débroussailleuses

Nuvola L-80,C3	0,70	BPMR7A	4626	02	5959
----------------	------	---------------	-------------	-----------	-------------

CLAEYS (FLANDRIA) - Tondeuses

Tous modèles	0,60	B4-LM	3410	05	4358
--------------	------	--------------	-------------	-----------	-------------

CLARK - Manutention

C500-20 / 25 / 30 / 40 / 55 / 60 / 70 / 80	0,60	AB-6	2910	-	-
C500 / 60 / 70 / 80 / 90	0,70	BPR4ES	7222	-	-
C500-100 / 120 / 130 / 150	0,60	AB-6	2910	-	-
Car Loader, CL 20 / 30 / 40 / 50	0,60	AB-6	2910	-	-
Clark 75	0,60	B6S	3510	09	6048
Clarkat, Clarkette, Clarklift C60 / C70 / C80	0,60	AB-6	2910	-	-
Clark-Ross Y200 Truck, Clarktor 6 / 120 / CFY / CY	0,60	B6S	3510	09	6048
Clarktor, 6Clipper	0,60	AB-6	2910	-	-
GCS12, 15, 20, 25, 27, 30 - Mot. Mitsubishi 4G32	0,70	BPR4ES	7222	-	-
GCS17, 20, 22, 25 - Mot. Mitsubishi 4G54	0,70	BPR4ES	7222	-	-
GCS17, 20, 22, 25, 27, 30	0,60	AB-6	2910	-	-
GCS175 - Mot. Mitsubishi 4G32	0,70	BPR4ES	7222	-	-
GCS27, 30 - Mot. Mitsubishi 4G54	0,60	BPR4ES	7222	-	-
GPS12, 15 - Mot. Mitsubishi 4G32	0,70	BPR4ES	7222	-	-
GPS20, 22, 25, 27, 30	0,60	AB-6	2910	-	-
GPS20, 22, 25, 27, 30 - Mot. Mitsubishi 4G54	0,70	BPR4ES	7222	-	-
HYL150	0,60	B6S	3510	09	6048

Modèle

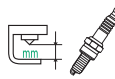

N° STOCK BOÎTE N° BLISTER N° STOCK BLISTER

CLARK - Manutention				
IT50 / 60 / 70 / 80 - Mot. Ford 300 ci. Ø18mm	0,60	AR6FS	3323	- -
IT50 / 60 / 70 / 80 - Ø14mm	0,60	B6S	7310	- -
Planeloader (Resistor)	0,60	BR6S	3522	09 6048
Ranger 150, 200, 300	0,60	B6S	3510	09 6048
S100	0,70	BPR4ES	7222	- -
Series 71F - Mot. Ford Ø18mm	0,60	AB-6	2910	- -
Series 71F - Mot. Ford Ø18mm siège conique	0,80	WR5	2438	- -
Series 71H, Series 81 Mot. Hercules	0,60	B6S	3510	09 6048
Tractor, Utilitrac, Yardlift 20 / 40 / 60 / 100 / 180	0,60	AB-6	2910	- -
Yardlist 150, 260	0,60	B6S	3510	09 6048
Yarklift 20 / 40 / 60 / 100 / 180	0,60	AB-6	2910	- -
YL 150 / 350	0,60	B6S	3510	09 6048

CLARK - Tondeuses				
Tous modèles	0,70	BR2-LM	5798	06 4740

CLEAN-CUT - Tondeuses				
Tous modèles	0,70	BR2-LM	5798	06 4740

CLEMSON - Tondeuses				
Tous modèles	0,70	BR2-LM	5798	06 4740

CLINTON - Générateurs				
412, 413, 492, 494, 498, 499	0,50	B4-LM	3410	05 4358
A-300, C-700, D-700, VS-900	0,50	B4-LM	3410	05 4358
Chief	0,70	BR6S	3522	09 6048
ChiefEdger	0,60	B-2	3110	- -
E-65, E-1290	0,50	B4-LM	3410	05 4358
V-1000/1100 / 1200, VS-1000 / 1100 / 1200 / 300	0,50	B4-LM	3410	05 4358

CLINTON - Tronçonneuses				
D 15 / 25 (1962-1965) Mot. 3 hp	0,80	BM6A	5921	01 5478
D 15 / 25, E 75 / 95	0,80	BMR6A	7421	01 5478
D 35 / 55 / 65 (1962-1978) 6 hp	0,80	BR6S	3522	09 6048
D 35 / 55 / 65 (1962-1978) Mot. 6 hp	0,80	B6S	3510	09 6048
E10 (1965) Mot. 3.6 ci.	0,70	BM7A	6521	10 6793
E 75 / 95 (1965) Mot. 4.48 ci.	0,80	BM6A	5921	01 5478

COLDWELL - Tondeuses				
Tous modèles	0,80	B2-LM	1147	06 4740

COLSON - Manutention				
Ø14mm	0,60	B-2	3110	- -
Ø18mm	0,60	AB-6	2910	- -

COLUMBIA - Tondeuses				
Tous modèles	0,70	BR2-LM	5798	06 4740

COMET - Tronçonneuses				
D4, D58	0,80	BMR6A	7421	01 5478
D51	0,70	B-6L	3212	- -

COMMERCIAL CLIPPER - Tondeuses				
Mot. Kohler Twin 18 / 20 hp	0,60	BPR4FS	1127	- -
Mot. Kohler V-Twin 22 / 25 hp	0,90	BKR5E	7938	07 4803

COMPANION - Tronçonneuses				
MS1 / MS2 / RS1 / RS2	0,60	BR6HS	3922	- -

CONTINENTAL - Générateurs				
700, 800, 900, 1100, 1200	0,60	B6S	3510	09 6048
AA, AC, AD, AU, AV, AW	0,60	B6S	3510	09 6048
B371, B405, B427, B6371, B6405, B6427	0,60	AB-6	2910	- -
E223, F124, F135, F140, F162, F163	0,60	AB-6	2910	- -
F06226	0,70	BP5ES	6511	03 6854
F186, F209, F226, F227, F244, F245, F4124	0,60	AB-6	2910	- -
F4140, F4162, F4163, F6226, G134, G157, G176	0,60	AB-6	2910	- -

Modèle

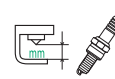

N° STOCK BOÎTE N° BLISTER N° STOCK BLISTER

G193	0,60	B6S	3510	09 6048
H227, H243, H260, H277, J382, J403	0,60	AB-6	2910	- -
K 6271 / 6298 / 6330 / 6363-Ø 14 mm	0,60	B6S	3510	09 6048
K 6271 / 6298 / 6330 / 6363-Ø 18 mm	0,60	AB-6	2910	- -
K6290, L6478, V8603	0,60	B6S	3510	09 6048
M271, M290, M330, M363, N56, N62, N4062	0,60	AB-6	2910	- -
NA62, OS202, R513, R572, R602	0,60	AB-6	2910	- -
R688-46, R800-46, R810-46, R839-46	0,60	BP6HS	4511	- -
R6513, R6572, R6602, U6501	0,60	B6S	3510	09 6048
RS542, S749, S820, S6749, S6820	0,60	AB-6	2910	- -
TC56, T274, T371, T6371, T6427, TS415	0,60	AB-6	2910	- -
TM27	0,60	BPR6ES	7822	04 7678
U-501, Y69, Y91, Y112, Y4069, Y4091, Y4112	0,60	AB-6	2910	- -
Z106, Z120, ZA120, ZA129, Z134	0,60	AB-6	2910	- -

CONVERTIBLE - Tondeuses				
1700 - Mot. Kawasaki V-Twin 17 hp	0,60	BCPR6ES	2330	- -
1700 - Mot. Kohler V-Twin CV17 17 hp	0,70	BKR5ES	2460	07 4803
2000 - Mot. Kohler V-Twin CV20 20 hp	0,70	BKR5ES	2460	07 4803
2200 - Mot. Kohler V-Twin CV22 22 hp	0,70	BKR5ES	2460	07 4803
2500 - Mot. Kohler V-Twin CV25 25 hp	0,70	BKR5ES	2460	07 4803
Mot. Kawasaki OHV 17 hp	0,80	BPR5ES	7422	03 6854
Mot. Kawasaki V-Twin 17 hp	0,70	BPMR6A	6726	08 5063
Mot. Kawasaki V-Twin 19 hp	0,70	BPR4ES	7222	- -
Mot. Kawasaki V-Twin OHV 25 hp	0,80	BPR4ES	7222	- -
Mot. Kohler V-Twin 17 / 20 / 22 / 25 hp	0,80	BKR5ES	2460	07 4803
Mot. Kohler V-Twin 30 hp	0,70	BKR5ES	2460	07 4803
Mot. Kohler V-Twin OHV 25 / 28 hp	0,70	BKR5ES	2460	07 4803

COOPER - Tondeuses				
Tous modèles	0,70	BR2-LM	5798	06 4740

COUNTRY CLIPPER - Tondeuses				
Challenger Mot. Kawasaki FS730V 24 hp	0,80	BPR4ES	7222	- -
Challenger Mot. Kohler Command 27 hp	0,70	BKR5ES	2460	07 4803
Charger Mot. Kawasaki FX801V 25.5 hp	0,80	BPR4ES	7222	- -
Charger Mot. Kohler Command 27 hp	0,70	BKR5ES	2460	07 4803
Defender Mot. Kawasaki FX1000V 35 hp	0,80	BPR5ES	7422	03 6854
Defender Mot. Kawasaki FX801V 25.5 hp	0,80	BPR4ES	7222	- -
Defender Mot. Kohler Command 27 hp	0,70	BKR5ES	2460	07 4803
Edge Mot. Kawasaki FR651V 21.5 hp	0,80	BPR4ES	7222	- -
Edge Mot. Kohler Courage 27 hp	0,70	BKR5ES	2460	07 4803
Edge XLT Mot. Kawasaki FS730V 24 hp	0,80	BPR4ES	7222	- -
Mot. B&S 11 / 12.5 / 18.5 hp	0,70	BR2-LM	5798	06 4740
Mot. B&S 15.5 hp, Mot. B&S Intek 20 hp	0,70	BKR5ES	2460	07 4803
Mot. B&S Twin 14 / 16 / 18 hp	0,70	BR2-LM	5798	06 4740
Mot. B&S Vanguard 23 hp	0,70	BKR5ES	2460	07 4803
Mot. Kawasaki 26 hp	0,60	BPR2ES	2264	- -
Mot. Kawasaki FD731V 15 hp	0,70	BPR4ES	7222	- -
Mot. Kawasaki FH451V 15 hp	0,60	BCPR6ES	2330	- -
Mot. Kawasaki FH601V 19 hp	0,70	BPR4ES	7222	- -
Mot. Kawasaki V-Twin 15 / 17 hp	0,70	BPMR6A	6726	08 5063
Mot. Kawasaki V-Twin 19 hp	0,80	BPR5ES	7422	03 6854
Mot. Kohler Command Pro 20 / 25 / 27 hp	0,90	BKR5E	7938	07 4803
Mot. Kohler Command Pro 23 hp	0,70	BKR5ES	2460	07 4803
Mot. Kohler mono-cyl. 17 hp	0,90	BKR5E	7938	07 4803
Mot. Kohler OHV 16 hp	0,70	BKR5ES	2460	07 4803
Mot. Kohler V-Twin 18 / 22 / 23 / 25 hp	0,90	BKR5E	7938	07 4803
Mot. Kohler V-Twin 30 hp	0,70	BKR5ES	2460	07 4803
Mot. Kohler V-Twin EFI 26 hp	0,90	BKR5E	7938	07 4803
Trek - Mot. Kawasaki V-Twin 15 hp	0,60	BCPR6ES	2330	- -
Wrangler Mot. Kawasaki FR651V 21.5 hp	0,80	BPR4ES	7222	- -
Wrangler Mot. Kohler Courage 22 hp	0,70	BKR5ES	2460	07 4803

CRAB - Manutention				
Tractor	0,60	AB-6	2910	- -

CRAFTSMAN - Débroussailleuses				
104.79211 / 104.79212 Mot. 25cc	0,60	CMR6A	1223	- -
271.281514 / 610.281514 / 611.281514	0,70	BMR6A	7421	01 5478
51715 / 51716 / 51718 / 79010 / 79011 Mot. 31cc	0,50	BPMR6F	1270	- -
79511 / 79521 / 79522 / 79550 / 79554 Mot. 25cc	0,50	BPMR7A	4626	02 5959
795410 / 795420 / 795430 / 795490	0,60	BM4A	5628	- -

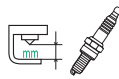

795440 / 795800 / 795900	0,70	BMR6A	7421	01	5478
796131	0,80	BM4A	5628	-	-
79822 / 79824 Mot. 31cc	0,50	BPMR6F	1270	-	-
Mot. B&S 6 hp	0,70	BKR5ES	2460	07	4803

CRAFTSMAN (SEARS) - Tronçonneuses

1.8, 1.9 PS, 2, 2.1 A, 2.7, 3.6, 4.3	0,80	BMR6A	7421	01	5478
3.7 / A / PS	0,70	BM7A	6521	10	6793
271-1.8, 271-2.7 A / VL	0,70	BMR6A	7421	01	5478
714.3 A / VL	0,70	BMR6A	7421	01	5478
35881	0,60	BPMR6A	6726	08	5063
35883	0,80	BM6A	5921	01	5478
35886	0,80	BM7A	6521	10	6793
3400 > 3402, 3408, 3411, 3412, 3415, 3416, 3418	0,70	BMR6A	7421	01	5478
3425, 3455, 3460, 3461, 3465, 3466, 3476, 3481	0,70	BMR6A	7421	01	5478
34071, 34094, 35082, 35091, 35093, 35094, 35096	0,70	BMR6A	7421	01	5478
35138, 35147, 35148, 3517	0,70	BM7A	6521	10	6793
35201, 35202, 35203, 35205, 35206	0,70	BMR6A	7421	01	5478
352030, 352060, 352070	0,60	BMR6A	7421	01	5478
35207, 35209, 35211, 35215, 35238	0,80	BMR6A	7421	01	5478
352090, 352321, 352351, 35265C	0,60	BMR6A	7421	01	5478
35232, 35251, 35255, 35256, 35263	0,80	BMR6A	7421	01	5478
35266, 35267, 35363, 35366, 35367	0,70	BMR6A	7421	01	5478
35269, 35365	0,60	BMR6F	2144	11	7683
35369, 35371, 35373C, 35377C	0,70	BMR6A	7421	01	5478
35484, 35608, 35609, 35885	0,60	BPMR6A	6726	08	5063
35505, 35506, 35512, 35514, 35515, 35516	0,60	BMR6A	7421	01	5478
35607, 35718, 35904	0,70	BM7A	6521	10	6793
35608, 35609	0,60	BPMR6A	6726	08	5063
35633, 35372/3/5/6	0,70	BM7A	6521	10	6793
357120, 357160	0,60	BMR6A	7421	01	5478
358356, 358850	0,60	BPMR6A	6726	08	5063
35889, 35628, 35883/6	0,70	BM7A	6521	10	6793
36096, 36212, 36235, 59716, 59741, 59816, 59886	0,60	BMR6A	7421	01	5478
59918, 59820	0,60	BPMR6A	6726	08	5063

CRAFTSMAN - Tondeuses

Mot. B&S 3 / 3.5 / 6 hp	0,70	BR2-LM	5798	06	4740
Mot. B&S Intek 6.5 hp	0,90	BKR5E	7938	07	4803
Mot. B&S OHV 6.5 hp	0,80	BKR5E	7938	07	4803
Mot. Honda 5 / 5.5 hp	0,80	BPR6ES	7822	04	7678
Mot. Tecumseh 3.5 / 4 / 5 hp	0,70	BR2-LM	5798	06	4740
Mot. Tecumseh OHV 4.5 / 5 / 6.75 hp	0,80	BR7ES	5122	-	-

CRAMER - Générateurs

3000 / 4000, B	0,60	BPR6ES	7822	04	7678
CM 60	0,60	BR4HS	3322	-	-
HS 450	0,60	BPR6ES	7822	04	7678
LS 3500 / 5000H	0,60	BR4HS	3322	-	-

CRAMER - Outils Divers

CM 60	0,60	BR4HS	3322	-	-
Combi Cut B, Garden Cut 4000, HS 450 BE	0,70	BPR6ES	7822	04	7678
KM 100H Mot. Honda GCV 160 OHC	0,80	BKR6E	6962	-	-
KM 70G / 80G Mot. Honda GCV 135	0,90	BPR6ES	7822	04	7678
KM 80H Mot. Honda GCV 160 OHC	0,80	BKR6E	6962	-	-
LS 3500 / LS 5000	0,70	BPR6ES	7822	04	7678
LS 5000 H	0,60	BR4HS	3322	-	-
LS 5000 HSW, LS 9000 HBS, LS Compact	0,70	BPR6ES	7822	04	7678
Tera Cut 3000	0,70	BPR6ES	7822	04	7678

CRAMER - Tondeuses

Cara 38 / 47 / 60 / 60T	0,70	BPR6ES	7822	04	7678
-------------------------	------	--------	------	----	------

CROWN - Tondeuses

Commando 218, 220, 221 / V / S, 418, 420, 421	0,70	BR4-LM	4133	05	4358
---	------	--------	------	----	------

CUB CADET - Débroussailleuses

19EHC / 24HC / 40HC Mot. 25.6cc	0,70	BPMR7A	4626	02	5959
SE26 / -C, ST23 / -C, 26 / -C, 35 / -C	0,70	BPMR7A	4626	02	5959

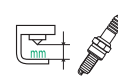

CUB CADET - Tondeuses

072R, 108R, 149R	0,70	BR2-LM	5798	06	4740
55, 182, 482	0,80	BMR6A	7421	01	5478
60, 70, 71, 72, 73, 86, 582	0,70	BR6S	3522	09	6048
75, 76, 80, 81, 85, 111, 282, 382	0,80	BMR6A	7421	01	5478
100, 102, 104, 105, 106, 107, 108, 109, 123, 124	0,70	B-6L	3212	-	-
125, 126, 127, 128, 129, 147, 149	0,70	B-6L	3212	-	-
800, 1000, 1100, 1200, 1450	0,70	B-6L	3212	-	-
982	0,80	TR4	3754	-	-
1030, 1225, 1238	0,70	BR2-LM	5798	06	4740
1325, 1330	0,80	BKR5E	7938	07	4803
1430	0,80	BPR4FS	1127	-	-
1440, 1641	0,80	BKR5E	7938	07	4803
1650	0,70	B-6L	3212	-	-
1730, 2082, 1861, 1862	0,80	BPR4FS	1127	-	-
1863, 1864, 2084, 2086, 2182, 2284	0,80	BKR5E	7938	07	4803
4814R	0,70	B-6L	3212	-	-
4815F, 4816F, 5416R, 5418F	0,80	BKR5E	7938	07	4803
702R, 899E, 899R	0,70	BR2-LM	5798	06	4740
AGS2130	0,80	BKR5E	7938	07	4803
AGS2140	0,70	BPR4HS	7823	-	-
AGS2150 / 2155, AGS2160 / Grizzly 4016	0,80	BKR5E	7938	07	4803
CC46ES / CC550ES Cub Cadet OHV 173cc	0,70	BKR5ES	2460	07	4803
CC760 Mot. B&S 344cc	0,70	BKR5ES	2460	07	4803
CC760ES Cub Cadet OHV 420cc	0,70	BKR5ES	2460	07	4803
CC94M Cub Cadet OHV 173cc	0,70	BKR5ES	2460	07	4803
CC98H Mot. Honda GCV160 OHV 160cc	0,80	BPR5ES	7422	03	6854
CC98M Cub Cadet OHV 173cc	0,70	BKR5ES	2460	07	4803
CC999E3 Mot. B&S 775 175cc	0,50	BKR5ES	2460	07	4803
GT1054 Pro. Mot. Kohler V-Twin OHV 27hp	0,70	BKR5ES	2460	07	4803
GT2000 Mot. Kohler Com. V-Twin OHV 20 hp	0,70	BKR5ES	2460	07	4803
GT2100 Mot. Kohler Com. V-Twin OHV 23 hp	0,70	BKR5ES	2460	07	4803
GTX1054 Pro. Mot. Kohler V-Twin OHV 27 hp	0,70	BKR5ES	2460	07	4803
GTX2000 Mot. Kohler Com. V-Twin OHV 20hp	0,70	BKR5ES	2460	07	4803
GTX2100 Mot. Kohler Com. V-Twin OHV 23hp	0,70	BKR5ES	2460	07	4803
HDS2135 / 2155 / 2185	0,80	BKR5E	7938	07	4803
HDS2145	0,70	BPR4HS	7823	-	-
HDS2165	0,80	BKR5E	7938	07	4803
LGT1050 Pro. Mot. Kohler V-Twin OHV 25hp	0,70	BKR5ES	2460	07	4803
LGT1054 Pro. Mot. Kohler V-Twin OHV 26hp	0,70	BKR5ES	2460	07	4803
LGTX1050 Pro. Mot. Kohler V-Twin OHV 25hp	0,70	BKR5ES	2460	07	4803
LGTX1054 Pro. Mot. Kohler V-Twin OHV 27hp	0,70	BKR5ES	2460	07	4803
LTX1040 Pro. Grade Kohler 1-Cyl. OHV 19hp	0,70	BKR5ES	2460	07	4803
LTX1042KH Pro. Kohler Cour. V-2 OHV 22hp	0,70	BKR5ES	2460	07	4803
LTX1042KW Pro. Kawa. V-Twin OHV 18hp	0,80	BPR4ES	7222	-	-
LTX1045 Pro. Grade Kohler 1-Cyl. OHV 20hp	0,70	BKR5ES	2460	07	4803
LTX1046KW Pro. Kawa. V-Twin OHV 21.5hp	0,80	BPR4ES	7222	-	-
LTX1046M Pro. Kohler V-Twin OHV 22hp	0,70	BKR5ES	2460	07	4803
LTX1050KH Pro. Kohler V-Twin OHV 24hp	0,70	BKR5ES	2460	07	4803
LTX1050KW Pro. Grade Kawa. V-2 OHV 23hp	0,80	BPR4ES	7222	-	-
Mot. B&S Intek 18.5 hp	0,70	BR2-LM	5798	06	4740
Mot. B&S Intek 17 / 20 / 22 hp	0,70	BKR5ES	2460	07	4803
Mot. B&S Vanguard 21 hp, V-Twin OHV 18 hp	0,70	BKR5ES	2460	07	4803
Mot. Honda 5.5 hp	0,70	BPR6ES	7822	04	7678
Mot. Honda GX670 24 hp	0,70	ZGR5A	5839	-	-
Mot. Honda V-Twin OHV 20 hp	0,70	BPR6ES	7822	04	7678
Mot. Kawasaki OHV (Refr. Liquide). 25 hp	0,60	BPR2ES	2264	-	-
Mot. Kawasaki OHV (Refr. Liquide). 29 hp	0,80	BPR4ES	7222	-	-
Mot. Kawasaki OHV 6 hp	0,60	BMR6A	7421	01	5478
Mot. Kawasaki OHV FH741V 25 hp	0,70	BCPR6ES	2330	-	-
Mot. Kawasaki V-Twin OHV 13 hp	0,70	BPR5ES	7422	03	6854
Mot. Kawasaki V-Twin OHV 15 / 19 hp	0,60	BCPR6ES	2330	-	-
Mot. Kawasaki V-Twin OHV 17 hp	0,70	BPMR6A	6726	08	5063
Mot. Kawasaki V-Twin OHV 22 hp	0,60	BMR6A	7421	01	5478
Mot. Kawasaki V-Twin OHV 23 hp	0,70	BPR4ES	7222	-	-
Mot. Kohler 23 hp	0,70	BKR5ES	2460	07	4803
Mot. Kohler Command 26 hp	0,70	BKR5ES	2460	07	4803
Mot. Kohler Command V-Twin OHV 16 / 18 / 20 hp	0,70	BKR5ES	2460	07	4803
Mot. Kohler Command V-Twin OHV 21 / 22 / 23 hp	0,70	BKR5ES	2460	07	4803
Mot. Kohler Command V-Twin OHV 25 / 27 hp	0,70	BKR5ES	2460	07	4803
Mot. Kohler Courage 18 / 19 / 20 hp	0,70	BKR5ES	2460	07	4803
Mot. Kohler Courage OHV 17 / 18 / 19 / 20 hp	0,70	BKR5ES	2460	07	4803
Mot. Kohler Courage V-Twin 23 hp	0,70	BKR5ES	2460	07	4803
Mot. Kohler Courage V-Twin OHV 23 / 25 / 27 hp	0,70	BKR5ES	2460	07	4803
Mot. Kohler OHV 27 hp	0,70	BKR5ES	2460	07	4803
Mot. Kohler V-Twin OHV 25 / 28 hp	0,70	BKR5ES	2460	07	4803

Modèle

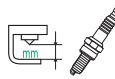
 N° STOCK BOÎTE
 N° BLISTER
 N° STOCK BLISTER

CUB CADET - Tondeuses

P418 / PS520	0,70	BR2-LM	5798	06	4740
RXT46 Pro. Kohler Cour. V-Twin OHV 22hp	0,70	BKR5ES	2460	07	4803
RZT Riders Mot. B&S 17 / 22hp	0,80	BKR5E	7938	07	4803
RZT42 Pro. Kohler Cour. V-Twin OHV 22hp	0,70	BKR5ES	2460	07	4803
RZT50-KH Pro. Kohler Cour. V-2 OHV 23hp	0,70	BKR5ES	2460	07	4803
RZT50-KW Pro. Kohler Cour. V-2 OHV 23hp	0,70	BKR5ES	2460	07	4803
RZT54-KH Pro. Kohler Cour. V-2 OHV 24hp	0,70	BKR5ES	2460	07	4803
RZT54-KW Pro. Kohler Cour. V-2 OHV 23hp	0,70	BKR5ES	2460	07	4803
RZTS42 Pro. Kohler Cour. V-Twin OHV 22hp	0,70	BKR5ES	2460	07	4803
RZTS46 Pro. Kohler Cour. V-Twin OHV 23hp	0,70	BKR5ES	2460	07	4803
RZTS50 Pro. Kohler Cour. V-Twin OHV 25hp	0,70	BKR5ES	2460	07	4803
RZTS54 Pro. Kohler Cour. V-Twin OHV 25hp	0,70	BKR5ES	2460	07	4803
S621 / SR621 - Mot. Kawasaki OHV 6.5 hp	0,80	BPR5ES	7422	03	6854
SC100 / SC500, SC500Z Cub Cadet OHV 159cc	0,80	BPR5ES	7422	03	6854
SC500E Cub Cadet OHV 173cc	0,80	BPR5ES	7422	03	6854
SC500HW Cub Cadet OHV 159cc	0,80	BPR5ES	7422	03	6854
SC621 / SC621E	0,70	BR2-LM	5798	06	4740
SRC621 / SRE621 - Mot. Kawasaki OHV 6.5hp	0,80	BPR5ES	7422	03	6854
SRX95 - Mot. B&S	0,70	BR2-LM	5798	06	4740
SRX95 - Mot. B&S série Intek / Vanguard	0,80	BKR5E	7938	07	4803
SRX95 - Mot. Honda V-Twin OHV 20/24 hp	0,80	BPR5ES	7422	03	6854
SRX95 - Mot. Kawa. V-Twin 20 / 25 / 28 hp	0,80	BMR6A	7421	01	5478
SRX95 - Mot. Kawasaki	0,80	BM4A	5628	-	-
SRX95 - Mot. Kawasaki 12.5 / 5.2 hp	0,80	BMR6A	7421	01	5478
SRX95 - Mot. Kawasaki 7 / 9 / 11 / 13 / 14 / 17 hp	0,80	BPR5ES	7422	03	6854
SRX95 - Mot. Kawasaki V-Twin 17 hp	0,70	BPMR6A	6726	08	5063
SRX95 - Mot. Kohler 10 / 12 / 14 / 16 / 20 hp	0,70	B-6L	3212	-	-
SRX95 - Mot. Kohler K181 8 hp	0,70	BR2-LM	5798	06	4740
SRX95 - Mot. Kohler OHV / V-Twin	0,80	BKR5E	7938	07	4803
SRX95 - Mot. Kohler Twin	0,80	BPR4FS	1127	-	-
SRX95 - Mot. Onan 316 / 318 / 420	0,80	TR4	3754	-	-
SRX95 - Mot. Onan E140H	0,70	BPR4HS	7823	-	-
SRX95 - Mot. Tecumseh	0,70	BR6S	3522	09	6048
SRX95 - Mot. Yanmar 322	0,80	BPR6ES	7822	04	7678
Tank LZ54 Kohler Command V-2 OHV 25hp	0,70	BKR5ES	2460	07	4803
Tank LZ60 KH Kohler Command V-2 OHV 27hp	0,70	BKR5ES	2460	07	4803
Tank LZ60 KW Kawa. FX V-2 OHV 27hp	0,80	BPR4ES	7222	-	-
Tank M72-KW Kawa. V-2 OHV 35hp	0,80	BPR5ES	7422	03	6854
Tank SZ48 Kohler Command V-2 OHV 23hp	0,70	BKR5ES	2460	07	4803
Tank SZ60 27hp Kawa. FX Series	0,80	BPR4ES	7222	-	-
Zforce48 Kohler Courage Pro V-2 OHV 22hp	0,70	BKR5ES	2460	07	4803
Zforce54 Kohler Courage Pro V-2 OHV 24hp	0,70	BKR5ES	2460	07	4803
ZforceS48 Pro. Mot. Kawa. V-2 OHV 21.5hp	0,80	BPR4ES	7222	-	-
ZforceS54 Pro. Mot. Kawa. V-2 OHV 23hp	0,80	BPR4ES	7222	-	-
ZforceS60 Pro. Mot. Kawa. V-2 OHV 24hp	0,80	BPR4ES	7222	-	-

CUNNINGHAM - Tondeuses

Tous modèles	0,70	BR2-LM	5798	06	4740
--------------	------	--------	------	----	------

CUSHMAN - Générateurs

Ø 18 mm	0,60	AP5FS	2610	-	-
w/Kohler K-181	0,60	B6S	3510	09	6048
w/Kohler K-301	0,60	B-6L	3212	-	-

CUSHMAN - Manutention

Minute Miser - Ø14 x 9,5mm	0,60	BM6A	5921	01	5478
Minute Miser - Ø14mm	0,60	B-6L	3212	-	-
Minute Miser - Ø18mm siège conique	0,80	WR5	2438	-	-
Minute Miser - Ø18mm siège plat	0,60	AB-6	2910	-	-
Cushman 18 hp	0,80	WR5	2438	-	-
Cushman 22 hp	0,70	UR4	6630	-	-
Mot. Kohler K181 8 hp	0,60	B6S	3510	09	6048
Mot. Kohler K301 12 hp	0,60	B-6L	3212	-	-
OMC M109, M218	0,80	WR5	2438	-	-

CUSHMAN - Tondeuses

OMC 218 & Autres modèles	1,00	WR5	2438	-	-
--------------------------	------	-----	------	---	---

DAIHATSU - Générateurs

CB 102	0,80	BP5EY	7327	-	-
DM 700 G / 950 G	0,80	BKR4E-11	5424	-	-
EB 104	0,60	BP5ES	6511	03	6854

Modèle

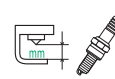
 N° STOCK BOÎTE
 N° BLISTER
 N° STOCK BLISTER

ED 104	0,80	BPR6EY	6427	-	-
ED 302 / 305	0,90	BPR4EY	2128	-	-

DANARM - Débroussailleuses

TM 10C, TM 20	0,70	BMR6A	7421	01	5478
TM 30B	0,60	BM4A	5628	-	-
Tomado 18E / 24E / 33E / 40E / 50E	0,70	BMR6A	7421	01	5478
Whipper 16 Mk3 / 18 E	0,70	BMR6A	7421	01	5478

DANARM - Tronçonneuses

1-36 / MKII / SS, 1-71 / SS, 2-36 / SS	0,70	BM7A	6521	10	6793
36AV, 55 / LH / RH, 76	0,70	BM7A	6521	10	6793
110 / Auto, 125 / Auto	0,80	BR6S	3522	09	6048

DAVIS - Manutention

Task Force 700 Trencher	0,60	AB-6	2910	-	-
-------------------------	------	------	------	---	---

DAYTON - Débroussailleuses

Tous modèles	0,70	BMR6A	7421	01	5478
--------------	------	-------	------	----	------

DAYTON - Tondeuses

Mot. Tecumseh	0,70	BR6S	3522	09	6048
---------------	------	------	------	----	------

DAYTON - Tronçonneuses

2Z461 / 462 / 463 / 463B / 573 / 760 / 970 / 970B	0,60	BMR6A	7421	01	5478
2Z971, 4Z022 / 023 / 023B / 109 / 109C	0,60	BMR6A	7421	01	5478
4Z251 / A	0,60	BPMR6A	6726	08	5063
4Z252	0,80	BMR7A	4226	10	6793

DEINES - Tondeuses

Mot. Onan	0,60	B-4L	3112	-	-
Mot. Tecumseh	0,60	BR6S	3522	09	6048

DERBI - Tronçonneuses

3230 / 5240	0,60	BMR6A	7421	01	5478
3835 / 6240	0,50	BM7A	6521	10	6793

DERBY - Tondeuses

Colt - Mot. Kohler Command 23 hp	0,70	BKR5ES	2460	07	4803
Morgan - Mot. B&S 20 hp	0,70	BKR5ES	2460	07	4803
Mot. B&S 20 / 25 hp, Mot. Kohler 14 / 23 hp	0,90	BKR5E	7938	07	4803
Pacer - Mot. B&S OHV 13 hp	0,70	BKR5ES	2460	07	4803

DEWEZE - Tondeuses

Mot. Kohler Twin 20 hp	0,60	BPR4FS	1127	-	-
Mot. Kohler V-Twin 25 hp	0,80	BCPR5ES	6130	07	4803
Mot. Onan Twin 20 hp	0,60	BPR5EFS	2223	-	-

DISSTON - Tronçonneuses

DA211 / G11AY / KB6AY / KB7AY	0,80	BR6S	3522	09	6048
DH120 / DO-100 / DO-101	0,60	B6S	3510	09	6048

DIXIE CHOPPER - Tondeuses

1942, Zee 1 Mot. B&S Intek XRD 19.5 hp	0,70	BKR5ES	2460	07	4803
2142, Zee 2 Mot. Kawasaki FR651V 21 hp	0,70	BPR4ES	7222	-	-
2244R Magnum Mot. Kawa. FS651V 22hp	0,70	BPR4ES	7222	-	-
2250HP Magnum HP Mot. Kawa. FX691V 22hp	0,70	BPR4ES	7222	-	-
2250R Magnum Mot. Kawasaki FS651V 22hp	0,70	BPR4ES	7222	-	-
2348, Zee 1 Mot. B&S Intek XRD 23 hp	0,70	BKR5ES	2460	07	4803
2348HP Zee 2 Mot. Kawasaki FS691V 23hp	0,70	BPR4ES	7222	-	-
2350 EFI Magnum HP Kohler EFI ECV680 23hp	0,70	BKR5ES	2460	07	4803
2354, Zee 2 Mot. Kawasaki FR691V 23hp	0,70	BPR4ES	7222	-	-
2354HP- Zee 2 Mot. Kawa. FS691V 23hp	0,70	BPR4ES	7222	-	-
2460HP Magnum HP Kawa. FX730V 23.5hp	0,70	BPR4ES	7222	-	-
2460R Magnum Mot. Kawa. FS730V 24hp	0,70	BPR4ES	7222	-	-
2660 Silver Eagle Kohler EFI ECV749 26hp	0,70	BKR5ES	2460	07	4803
2744 / 2750 Silver Eagle - Generac GTV760 27hp	0,70	BKR5ES	2460	07	4803
2750T Classic T&W Mot. Kawa. FX850V 27hp	0,70	BPR4ES	7222	-	-
2750W Classic T&W Generac GTV760 27hp	0,70	BKR5ES	2460	07	4803

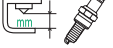
Modèle			N° STOCK BOÎTE	N° BLISTER	N° STOCK BLISTER
2760 Silver Eagle Mot. Generac GTV760 27hp	0,70	BKR5ES	2460	07	4803
2760KW Silver Eagle Kawa. FX850V 27hp	0,70	BPR4ES	7222	-	-
2760T Classic T&W Mot. Kawa. FX850V 27hp	0,70	BPR4ES	7222	-	-
2760W Classic T&W Generac GTV760 27hp	0,70	BKR5ES	2460	07	4803
3356 XCaliber 4X4 Generac GTV990 33hp	0,70	BKR5ES	2460	07	4803
3360H / 3366 Mot. Generac GTV990 33hp	0,70	BKR5ES	2460	07	4803
3360W Classic T&W Generac GTV990 33hp	0,70	BKR5ES	2460	07	4803
3372HP Classic Generac GTV990 33hp	0,70	BKR5ES	2460	07	4803
3374 XCaliber Mot. Generac GTV990 33hp	0,70	BKR5ES	2460	07	4803
3560T Classic T&W Kawa. FX1000V 35hp	0,70	BPR5ES	7422	03	6854
5474 XCaliber Twin 2X Generac GTV760 27hp	0,70	BKR5ES	2460	07	4803
Mot. B&S 5 hp	0,70	BR2-LM	5798	06	4740
Mot. Generac 27 hp	0,80	BKR4E	4421	-	-
Mot. Honda GX670 24 hp	0,70	ZGR5A	5839	-	-
Mot. Honda OHV 24 hp	0,80	BPR5ES	7422	03	6854
Mot. Kawasaki FH721D / FH721V 25 hp	0,80	BPR4ES	7222	-	-
Mot. Kawasaki V-Twin 19 / 23 / 25 hp	0,80	BPR5ES	7422	03	6854
Mot. Kohler 16 hp	0,80	BPR4FS	1127	-	-
Mot. Kohler 17 / 20 / 25 hp	0,70	BKR5ES	2460	07	4803
Mot. Kohler Comm. Pro V-Twin 26 / 27 / 28 hp	0,70	BKR5ES	2460	07	4803
Mot. Kohler OHV 6 hp	0,80	BKR5E	7938	07	4803
Mot. Kohler Twin 18 / 20 hp	0,80	BPR4FS	1127	-	-
Mot. Kohler V-Twin 20 / 22 / 25 / 26 hp	0,80	BKR5E	7938	07	4803
Mot. Onan Twin 24 hp	0,80	TR4	3754	-	-
SilverEagle - Mot. Kohler 18 hp	0,70	BKR5ES	2460	07	4803
WB22 / 24 - Mot. B&S 6,75 hp	0,70	BKR5ES	2460	07	4803
WB36 Mot. Kohler 15 hp	0,70	BKR5ES	2460	07	4803
XWF3000-60 Mot. Kohler 30 hp	0,70	BKR5ES	2460	07	4803

DIXON - Tondeuses

D160H22 Mot. Honda GCV 9,76 in3	0,80	BPR5ES	7422	03	6854
D20KH42 Mot. Kohler Courage 20 hp	0,70	BKR5ES	2460	07	4803
D21KH26 Mot. Kohler Courage 21 hp	0,70	BKR5ES	2460	07	4803
D224GYT Mot. Kohler Courage V-Twin 22 hp	0,70	BKR5ES	2460	07	4803
D26KH48 Mot. Kohler Courage V-Twin 26 hp	0,70	BKR5ES	2460	07	4803
DX148 Mot. Kawasaki FX651V 20,5 hp	0,80	BPR4ES	7222	-	-
DX152 Mot. Kawasaki 24 hp	0,80	BPR4ES	7222	-	-
DX152 Mot. Kawasaki FX691V 22 hp	0,80	BPR4ES	7222	-	-
DX161 Mot. B&S 49L977-0110-G1 28 hp	0,70	BKR5ES	2460	07	4803
DX161 Mot. Kawasaki FX730V	0,80	BPR4ES	7222	-	-
DX254 Mot. Kawasaki FX751 24,5 hp	0,80	BPR4ES	7222	-	-
DX260 Mot. Kawasaki FX Series 25,5 hp	0,80	BPR4ES	7222	-	-
DX260 / DX272 Mot. Kawasaki FX921V 31 hp	0,80	BPR5ES	7422	03	6854
Mot. B&S 10 / 11 / 13 hp & Modèles à bras	0,70	BR2-LM	5798	06	4740
Mot. B&S 9 / 14 hp, Mot. B&S Intek 14,5 / 15,5 hp	0,70	BKR5ES	2460	07	4803
Mot. B&S Vanguard 15,5 hp	0,70	BKR5ES	2460	07	4803
Mot. Kawasaki (Refr. Liquide). 27 hp	0,60	BPR2ES	2264	-	-
Mot. Kawasaki FH Series 19 hp	0,60	BCPR6ES	2330	-	-
Mot. Kohler 15 hp	1,10	BKR5ES-11	2382	-	-
Mot. Kohler 18 / 20 / 22 hp	0,70	BKR5ES	2460	07	4803
Mot. Kohler Command 14 / 15 hp	1,00	BKR5ES-11	2382	-	-
Mot. Kohler Command 16 / 23 hp / Pro 25 hp	0,70	BKR5ES	2460	07	4803
Ram 48 ZT Mot. B&S 44P777-03278-G1 26 hp	0,70	BKR5ES	2460	07	4803
Speed ZTR30 Mot. B&S Intek OHV AVS 16,5hp	0,90	BCPR5ES	6130	07	4803
Speed ZTR30 Mot. B&S Intek XRD 16,5 hp	0,70	BKR5ES	2460	07	4803
Speed ZTR42SE Mot. Kawa. FR651V 21,5 hp	0,80	BPR4ES	7222	-	-
Speed ZTR48 SE - ZTR54 - Kawa. FR730V 24hp	0,80	BPR4ES	7222	-	-
Ultra 52 Kohler Courage Pro V-2 SV830 25 hp	0,70	BKR5ES	2460	07	4803
Ultra 61 Mot. Kohler Courage CV740 27 hp	0,70	BKR5ES	2460	07	4803

DOLMAR - Débroussailleuses

BC 210 / 212	0,50	BMR6F	2144	11	7683
BC 250 / 330 / 400	0,50	BPMR6F	1270	-	-
CS-246.4C / CS-2464C BC Mot. 25,4cc	0,50	CMR4A	5474	-	-
HT-2045D / 2062E Mot. Robin 1.1 hp	0,70	BM7A	6521	10	6793
HT-2145D / 2162E Mot. Robin 21cc	0,60	BPM7A	7321	02	5959
HT-2249D Mot. 21cc	0,50	BPMR4A	6028	-	-
HT-2256D	0,60	BMR7A	4226	10	6793
LT-160	0,80	BPMR6F	1270	-	-
LT-210 Mot. 21cc Robin	0,60	BPM7A	7321	02	5959
LT-250 Mot. 24,5cc Robin	0,60	BM7A	6521	10	6793
LT-30 Mot. 30cc Dolmar	0,70	BPMR7A	4626	02	5959
MH-2556 Mot. 24,5cc	0,60	BMR7A	4226	10	6793
MS-20C Mot. Robin 1.1 hp / 19,8cc	0,60	BM7A	6521	10	6793
MS-22C Mot. Robin 21cc	0,60	BPM7A	7321	02	5959

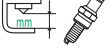
Modèle			N° STOCK BOÎTE	N° BLISTER	N° STOCK BLISTER
MS-25C	0,70	BPMR7A	4626	02	5959
MS-25U	0,60	BPMR6A	6726	08	5063
MS-30C / MS-30U Mot. Dolmar 30cc	0,50	BPMR7A	4626	02	5959
MS-220 / 221 / 251	0,70	BMR7A	4226	10	6793
MS-230C / 231C Mot. Mitsubishi 22,6cc	0,50	BPMR8Y	2218	-	-
MS-245.4 Mot. 24,5cc	0,80	CMR4A	5474	-	-
MS-245.4C / MS-245.4U / 246.4C - Mot. 24,5cc	0,50	CMR4A	5474	-	-
MS-250	0,70	BMR7A	4226	10	6793
MS-250.4	0,60	CMR6A	1223	-	-
MS-253 Mot. Robin 24,5cc	0,60	BPM7A	7321	02	5959
MS-256.4C Mot. 25,4cc	0,50	CMR4A	5474	-	-
MS-260C / 260U / 261C / 261C Mot. Mitsu. 25,6cc	0,50	BPMR8Y	2218	-	-
MS-330C / 330U / 311C / 311U Mot. Mitsu. 32,6cc	0,50	BPMR8Y	2218	-	-
MS-335.4C Mot. 33,5cc	0,50	CMR4A	5474	-	-
MS-2300 / 3100	0,70	BMR7A	4226	10	6793
MS-2501 Mot. Robin 1.3 kW 24,5cc	0,60	BM7A	6521	10	6793
MS-2514 Mot. Robin 24,5cc	0,60	CMR6A	1223	-	-
MS-2600	0,70	BPMR7A	4626	02	5959
MS-2810 Mot. Robin 1,5 hp	0,50	BM7A	6521	10	6793
MS-2810 Mot. Robin 27,2cc	0,60	BM7A	6521	10	6793
MS-3200 Mot. Dolmar 30,5cc	0,70	BPMR7A	4626	02	5959
MS-3200 Mot. Robin 30,5cc	0,50	BPMR7A	4626	02	5959
MS-3210 Mot. Dolmar 30,5cc	0,70	BPMR7A	4626	02	5959
MS-3300 Mot. Dolmar 33cc	0,60	BMR7A	4226	10	6793

DOLMAR - Générateurs

309, 343 Happy Start	0,70	BPMR7A	4626	02	5959
G 5800, G 6100 R	0,70	BR7ES	5122	-	-
GE 5800 Robin 11 hp	0,60	B6ES	7310	-	-
HP 450	0,70	BPMR7A	4626	02	5959
HT-2256 D, HT-2276 E	0,60	BMR7A	4226	10	6793
PB 500R, PC-6412 / 7314	0,70	BPMR7A	4626	02	5959
PD-491	0,60	BPMR7A	4626	02	5959

DOLMAR - Outils Divers

309 / 343	0,50	BPMR7A	4626	02	5959
HT 2256 D, HT 2276 E	0,60	BMR7A	4226	10	6793
PB 250	0,70	BMR7A	4226	10	6793
PC 6412 / 7314	0,50	BPMR7A	4626	02	5959
PD 491	0,60	BPMR7A	4626	02	5959

DOLMAR - Tondeuses

LT-30 / MS-30 C	0,50	BPMR7A	4626	02	5959
MS-220	0,60	BMR7A	4226	10	6793
PM-43 / 48 / 48 S / 4645 S / S2 / S2E / 5360 S3CP	0,60	BR2-LM	5798	06	4740
PM-4035 / 4645 SE / 5355 S / 5355 SE	0,60	B2-LM	1147	06	4740
PM-4040 / 4045 / 4640 HSM / 4645	0,60	BR2-LM	5798	06	4740
PM-4650HS Mot. Honda GXV140	0,70	BPR6ES	7822	04	7678
PV-4034	0,60	BR2-LM	5798	06	4740
TM 85.13 / 85.13 H / 102.13 / 102.17 H	0,60	BKR5ES	2460	07	4803

DOLMAR - Tronçonneuses

100 / 100 Super - Mot. Dolmar 33cc 13hp	0,50	BPMR6F	1270	-	-
101 / 104 / 106	0,70	BPMR6A	7421	01	5478
102 - Mot. Dolmar 39cc 13 hp	0,50	BPMR6F	1270	-	-
103 / 105 / 108 - Mot. Dolmar 40 cc	0,60	BMR6A	7421	01	5478
109, 110 (de 07,86 à ...), 110i - Dolmar 43cc	0,50	BPMR7A	4626	02	5959
110 (jusqu'à 06,86)	0,50	BPMR6F	1270	-	-
111 / 111i - Mot. Dolmar 51cc	0,50	BPMR7A	4626	02	5959
112 / 113 / 114 / 121 / 122 / 123	0,60	BPMR7A	4626	02	5959
112 / Super, 113 / Super - Dolmar 51,7cc	0,50	BPMR7A	4626	02	5959
114 / 115 / 115i / 116 - Mot. Dolmar 51,7cc	0,50	BPMR7A	4626	02	5959
116i / 116Si / 120 - Mot. Dolmar 60cc	0,50	BPMR7A	4626	02	5959
117 / 118 / 119 - Mot. Dolmar 60cc	0,50	BPMR7A	4626	02	5959
118	0,50	BM7A	6521	10	6793
118 S, 119	0,50	BPM7A	7321	02	5959
120 s (02.1987-->)	0,50	BPMR7A	4626	02	5959
120 Super / Si - Mot. Dolmar 68cc	0,50	BPMR7A	4626	02	5959
122 S / SL	0,50	BM7A	6521	10	6793
123 - Mot. Dolmar 70 cc	0,50	BPMR7A	4626	02	5959
128 / 144 / 152 / 153 / 166 / 310	0,60	BPMR7A	4626	02	5959
128 KMS4	0,70	BM7A	6521	10	6793
128 KMS4 Rotary	0,50	BPMR7A	4626	02	5959
133 / Super - Mot. Dolmar 85 cc	0,50	BPMR7A	4626	02	5959

Modèle

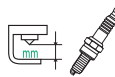
 N° STOCK
 N° BLISTER
 N° BOÎTE
 N° BLISTER

DOLMAR - Tronçonneuses					
143 - Mot. Dolmar 95 cc	0,50	BPMR7A	4626	02	5959
160 / 308, 166 - Mot. Dolmar 118cc	0,50	BPMR7A	4626	02	5959
309 Mot. 70cc Dolmar, 343 Mot. 95cc Dolmar	0,50	BPMR6A	6726	08	5063
PS-32 Mot. 32cc Dolmar	0,50	CMR7A	7543	-	-
PS-33 / 330	0,50	BPMR6F	1270	-	-
PS-34 - Mot. Dolmar 33cc	0,50	BPMR7A	4626	02	5959
PS-35 / 41 / 45, PS-350 Mot. 35cc Dolmar	0,50	BPMR7A	4626	02	5959
PS-45 Mot. 45.1cc Dolmar	0,50	BPMR7A	4626	02	5959
PS-340 / 341 - Mot. Dolmar 33cc, PS-344	0,50	BPMR6F	1270	-	-
PS-351 Mot. 34.7cc Dolmar	0,50	CMR7A	7543	-	-
PS-400 / 401 - Mot. Dolmar 39cc	0,50	BPMR6F	1270	-	-
PS-410/33, 411/33	0,50	BPMR6F	1270	-	-
PS-420, 500	0,50	BPMR7A	4626	02	5959
PS-420 Mot. 42cc Dolmar	0,50	BPMR7A	4626	02	5959
PS-421 Mot. 42.4cc Dolmar	0,50	CMR7A	7543	-	-
PS-460 - Mot. Dolmar 45.6cc	0,50	BPMR7A	4626	02	5959
PS-510 - Mot. Dolmar 49.9cc	0,50	BPMR7A	4626	02	5959
PS-540 Mot. Dolmar 54cc	0,50	BPMR7A	4626	02	5959
PS-3300 TH - Mot. Tanaka 32.3cc	0,50	BMR6A	7421	01	5478
PS-3410 / 4600 / 4605 / 5000 / 5105	0,50	BPMR7A	4626	02	5959
PS-5100S, PS-5105H Mot. 50cc Dolmar	0,50	BPMR7A	4626	02	5959
PS-5100S / 6000i / H - Mot. Dolmar 60cc	0,50	BPMR7A	4626	02	5959
PS-6100 Mot. 61cc Dolmar	0,50	BPMR7A	4626	02	5959
PS-6400 - Mot. Dolmar 64cc	0,80	BPMR7A	4626	02	5959
PS-6800i / H - Mot. Dolmar 68cc	0,80	BPMR7A	4626	02	5959
PS-7300 - Mot. Dolmar 73 cc	0,50	BPMR7A	4626	02	5959
PS-7310 / 7310H Mot. 72.6cc Dolmar	0,50	BPMR7A	4626	02	5959
PS-7900 - Mot. Dolmar 79cc	0,50	BPMR7A	4626	02	5959
PS-7910 / 7910H / 7910XD Mot. Dolmar 78.5cc	0,50	BPMR7A	4626	02	5959
PS-7910XD Mot. Dolmar 78.5cc	0,50	BPMR7A	4626	02	5959
PS-9000 / 9010 - Mot. Dolmar 90cc	0,50	BPMR7A	4626	02	5959
PS-9010i - Mot. Dolmar 5.1 KW	0,50	BPMR7A	4626	02	5959
S6000	0,50	BPMR7A	4626	02	5959

DUNLAP - Tondeuses

Mot. B&S	0,70	BR2-LM	5798	06	4740
Mot. Power Product	0,60	BR6S	3522	09	6048

DUO-THERM - Tondeuses

Tous modèles	0,70	BR2-LM	5798	06	4740
--------------	------	--------	------	----	------

DYNA MOW - Tondeuses

Modèles à bras	0,70	BR2-LM	5798	06	4740
Mot. Ford 1.1 / 1.3L	0,90	BPR6EFS	3623	-	-
Mot. Kawasaki Liq. V-Twin 29 hp	0,80	BPR5ES	7422	03	6854
Mot. Kawasaki Refroid Liq V-Twin 20 hp	0,80	BMR6A	7421	01	5478
Mot. Kawasaki V-Twin 23 hp	0,80	BPR5ES	7422	03	6854
Mot. Kohler V-Twin 25 hp	0,90	BKR5E	7938	07	4803

DYNAHOE - Manutention

3/4 Ton - Mot. Perkins G4-203	0,60	BP5ES	6511	03	6854
Continental F244	0,60	AB-6	2910	-	-

DYNAMARK - Tondeuses

Mot. B&S 3.5 / 3.75 / 4 / 5 / 11 / 12 / 12.5 hp	0,70	BR2-LM	5798	06	4740
Mot. B&S Twin	0,70	BR2-LM	5798	06	4740
Mot. Kawasaki Refroid. Liq. V-Twin 20 hp	0,80	BMR6A	7421	01	5478
Mot. Tecumseh	0,70	BR6S	3522	09	6048

EAGER BEAVER - Tondeuses

Mot. B&S	0,70	BR2-LM	5798	06	4740
----------	------	--------	------	----	------

EASY WAY - Tondeuses

Tous modèles	0,50	BR2-LM	5798	06	4740
--------------	------	--------	------	----	------

EATON - Tondeuses

Mot. B&S	0,70	BR2-LM	5798	06	4740
Mot. Tecumseh	0,60	BR4-LM	4133	05	4358

Modèle

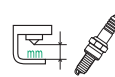
 N° STOCK
 N° BLISTER
 N° BOÎTE
 N° BLISTER

EATON - Tronçonneuses					
8767, 8768-9	0,80	BR6S	3522	09	6048
8930, 8932-3	0,60	BMR6A	7421	01	5478

ECHO - Débroussailleuses

CLS 4600	0,60	BPM7A	7321	02	5959
CSAH 302, DM 9	0,60	BMR6A	7421	01	5478
GT 160 / 160A / 160 AE, GT 200	0,60	BMR6A	7421	01	5478
GT 225 / GT 225 Mot. 21.2cc	0,60	BPMR8Y	2218	-	-
GT 230 Serial # Prefix 05	0,60	BPM8Y	2057	-	-
GT 230 Serial # Prefix 07	0,80	BPMR8Y	2218	-	-
GT 231 Serial Prefix 02	0,60	BPM7A	7321	02	5959
GT 231 Serial Prefix 06	0,60	BPM8Y	2057	-	-
GT 1000	0,50	BMR6A	7421	01	5478
GT 1100	0,70	BPMR7A	4626	02	5959
GT 2000 / GT 2000 SB	0,60	BPM7A	7321	02	5959
GT 2000 EZR Serial # Prefix 03	0,60	BPM7A	7321	02	5959
GT 2000 EZR Serial # Prefix 04	0,60	BPMR7A	4626	02	5959
GT 2000 R Serial # Prefix 03	0,60	BPM7A	7321	02	5959
GT 2010	0,70	BPMR7A	4626	02	5959
GT 2100 / 2200	0,60	BPM7A	7321	02	5959
GT 2400	0,60	BPM7A	7321	02	5959
GTB 2103	0,60	BPMR7A	4626	02	5959
GTL 140 / 140 A / 140 B, HC 140	0,60	BMR6A	7421	01	5478
HC 150 i Serial # Prefix 05, 06, 08 & 09	0,60	BPM8Y	2057	-	-
HC 150 i Serial # Prefix 07 & 10	0,60	BPMR8Y	2218	-	-
HC 150 Serial # Prefix 05, 06, 08 & 09	0,60	BPM8Y	2057	-	-
HC 150 Serial # Prefix 07 & 10	0,60	BPMR8Y	2218	-	-
HC 151 i Serial # Prefix 05, 06, 08 & 09	0,60	BPM8Y	2057	-	-
HC 151 Serial # Prefix 02 / 05 / 06 / 08 / 09	0,60	BPM8Y	2057	-	-
HC 152 / HC 155 Mot. 21.2cc	0,60	BPMR8Y	2218	-	-
HC 160 / 160 A	0,60	BMR6A	7421	01	5478
HC 160 Serial # Prefix 05, 06, 08 & 09	0,60	BPM8Y	2057	-	-
HC 160 Serial # Prefix 07 & 10	0,60	BPMR8Y	2218	-	-
HC 161 Serial # Prefix 02	0,60	BPM7A	7321	02	5959
HC 161 Serial # Prefix 05, 06, 08 & 09	0,60	BPM8Y	2057	-	-
HC 165 Mot. 21.2cc	0,60	BPMR8Y	2218	-	-
HC 180 Serial # Prefix 05, 06, 08 & 09	0,60	BPM8Y	2057	-	-
HC 180 Serial # Prefix 07 & 10	0,60	BPMR8Y	2218	-	-
HC 181 Serial # Prefix 05, 06, 08 & 09	0,60	BPM8Y	2057	-	-
HC 185 Mot. 21.2cc	0,60	BPMR8Y	2218	-	-
HC 200 / 200AE / 200E	0,60	BMR6A	7421	01	5478
HC 200 Serial # Prefix 05, 06, 08 & 09	0,60	BPM8Y	2057	-	-
HC 200 Serial # Prefix 07 & 10	0,60	BPMR8Y	2218	-	-
HC 201 Serial # Prefix 02 / 05 / 06 / 08 / 09	0,60	BPM8Y	2057	-	-
HC 210 E, HC 220 E	0,60	BMR6A	7421	01	5478
HC 230 Serial # Prefix 05 & 06	0,60	BPM8Y	2057	-	-
HC 230 Serial # Prefix 07	0,60	BPMR8Y	2218	-	-
HC 231 Serial # Prefix 05 & 06	0,60	BPM8Y	2057	-	-
HC 231 Serial # Prefix 07	0,60	BPMR8Y	2218	-	-
HC 233 Serial # Prefix 02	0,60	BPM7A	7321	02	5959
HC 233 Serial # Prefix 06	0,60	BPM8Y	2057	-	-
HC 234 Serial # Prefix 02	0,60	BPM7A	7321	02	5959
HC 234 Serial # Prefix 06	0,60	BPM8Y	2057	-	-
HC 235 Mot. 21.2cc, HC 245 Mot. 21.2cc	0,60	BPMR8Y	2218	-	-
HC 1500	0,60	BPM7A	7321	02	5959
HC 1600	0,60	BPM7A	7321	02	5959
HC 2000	0,60	BPM7A	7321	02	5959
HC 2100	0,60	BPM7A	7321	02	5959
HC 2400 / 2410	0,60	BPM7A	7321	02	5959
HCA 2400	0,60	BPM7A	7321	02	5959
HCA 260 Serial # Prefix 05 & 06	0,60	BPM8Y	2057	-	-
HCA 260 Serial # Prefix 07	0,60	BPMR8Y	2218	-	-
HCA 261 Serial # Prefix 02	0,60	BPM7A	7321	02	5959
HCA 261 Serial # Prefix 05 & 06	0,60	BPM8Y	2057	-	-
HCA 266 Mot. 25.4cc	0,60	BPM8Y	2057	-	-
HCR 150 Serial # Prefix 05 & 06	0,60	BPM8Y	2057	-	-
HCR 150 Serial # Prefix 07	0,60	BPMR8Y	2218	-	-
HCR 151 Serial # Prefix 02	0,60	BPM7A	7321	02	5959
HCR 151 Serial # Prefix 05 & 06	0,60	BPM8Y	2057	-	-
HCR 1500, HCR 2400	0,60	BPM7A	7321	02	5959
HT 200	0,60	BMR6A	7421	01	5478
PE 201 / 231 / 261 / 310 / 2000 / 2601 / 3100	0,60	BPM7A	7321	02	5959
PE 260	0,60	BPMR7A	4626	02	5959
RM 200 E	0,60	BM6A	5921	01	5478

Modèle		N°		
		STOCK	BLISTER	STOCK
		BOÎTE	BLISTER	BLISTER
RM 250 / 281	0,60	BPMR7A	4626	02 5959
RM 303 E	0,60	BM6A	5921	01 5478
RM 310 / 311 / 356 / 380, RMA 2530, RMB 250	0,60	BPMR7A	4626	02 5959
RMB 303 E	0,60	BM6A	5921	01 5478
RMB 310 / 311, RMHB 230	0,60	BPMR7A	4626	02 5959
SHC 1700	0,60	BPM7A	7321	02 5959
SHC 210 Serial # Prefix 05, 06, 08 & 09	0,60	BPM8Y	2057	- -
SHC 210 Serial # Prefix 07 & 10	0,60	BPMR8Y	2218	- -
SHC 211 Serial # Prefix 02	0,60	BPM7A	7321	02 5959
SHC 211 Serial # Prefix 05, 06, 08 & 09	0,60	BPM8Y	2057	- -
SHC 212 Serial # Prefix 09	0,60	BPM8Y	2057	- -
SHC 225 / 225 S Mot. 21.2cc	0,60	BPMR8Y	2218	- -
SHC 260 Serial # Prefix 05 & 06	0,60	BPM8Y	2057	- -
SHC 260 Serial # Prefix 07	0,60	BPMR8Y	2218	- -
SHC 261 Serial # Prefix 02	0,60	BPM7A	7321	02 5959
SHC 261 Serial # Prefix 05 & 06	0,60	BPM8Y	2057	- -
SHC 266 Mot. 25.4cc	0,60	BPM8Y	2057	- -
SHC 2100, SHC 2400	0,60	BPM7A	7321	02 5959
SRA 2190 / 2530, SRA 343 SL, SRAB 2190	0,60	BPMR7A	4626	02 5959
SRB 261U Serial # Prefix 06	0,60	BPM8Y	2057	- -
SRM 140 D / 140 DA / 141 D	0,60	BMR6A	7421	01 5478
SRM 160 / 160 AE, SRM 200 / 200 AE / 200 B	0,60	BMR6A	7421	01 5478
SRM 200 BE / 200 D	0,50	BMR6A	7421	01 5478
SRM 200 DA	0,60	BMR6A	7421	01 5478
SRM 200 DB	0,50	BMR6A	7421	01 5478
SRM 200 EB	0,60	BMR6A	7421	01 5478
SRM 201 FA / 202 DA / 202 FA	0,60	BMR6A	7421	01 5478
SRM 210 AE / 210 E	0,50	BMR6A	7421	01 5478
SRM 211 SB Serial # Prefix 02	0,60	BPM7A	7321	02 5959
SRM 211 SB Serial # Prefix 06 & 09	0,60	BPM8Y	2057	- -
SRM 211 Serial # Prefix 02	0,60	BPM7A	7321	02 5959
SRM 211 Serial # Prefix 06 & 09	0,60	BPM8Y	2057	- -
SRM 211 U Serial # Prefix 02, 06 & 09, SRM 2110	0,60	BPM7A	7321	02 5959
SRM 220 BE	0,50	BMR6A	7421	01 5478
SRM 225 i / 225 U Mot. 21.2cc	0,60	BPMR8Y	2218	- -
SRM 230	0,70	BPMR7A	4626	02 5959
SRM 230 Mot. 22.8cc	0,60	BPMR8Y	2218	- -
SRM 230 U Serial # Prefix 05 & 06	0,60	BPM8Y	2057	- -
SRM 230 U Serial # Prefix 07	0,80	BPMR8Y	2218	- -
SRM 231 Serial # Prefix 02	0,60	BPM7A	7321	02 5959
SRM 231 Serial # Prefix 06	0,60	BPM8Y	2057	- -
SRM 250 E / EL / EU, SRM 2500 / 2510	0,60	BPMR7A	4626	02 5959
SRM 255 Mot. 21.2cc	0,60	BPMR8Y	2218	- -
SRM 260 / S Serial # Prefix 03	0,60	BPM7A	7321	02 5959
SRM 260 / S Serial # Prefix 04	0,70	BPMR7A	4626	02 5959
SRM 260 / S / SB / U Serial # Prefix 05 & 06	0,60	BPM8Y	2057	- -
SRM 260 / S / SB / U Serial # Prefix 07	0,80	BPMR8Y	2218	- -
SRM 261 / S / SB Serial # Prefix 02	0,60	BPM7A	7321	02 5959
SRM 261 / S / SB Serial # Prefix 06	0,60	BPM8Y	2057	- -
SRM 266 S / 266 T Mot. 25.4cc	0,60	BPMR8Y	2218	- -
SRM 266 U Mot. 25.4cc	0,60	BPM8Y	2057	- -
SRM 280 / 280 S / 280 T Mot. 28.1cc	0,60	BPMR8Y	2218	- -
SRM 280 U Mot. 28.1cc	0,60	BPM8Y	2057	- -
SRM 300 ESL	0,60	BPMR8Y	2218	- -
SRM 302 BDX	0,70	BPMR7A	4626	02 5959
SRM 310 E	0,60	BPMR7A	4626	02 5959
SRM 310 S / U Serial # Prefix 03	0,60	BPM8Y	2057	- -
SRM 310 S / U Serial # Prefix 04	0,80	BPMR8Y	2218	- -
SRM 330 ES	0,60	BPMR7A	4626	02 5959
SRM 340 Serial # Prefix 03	0,60	BPM7A	7321	02 5959
SRM 340 Serial # Prefix 04	0,80	BPMR8Y	2218	- -
SRM 345 S / SL, SRM 350 ES	0,60	BPMR7A	4626	02 5959
SRM 400 AE / B / E	0,60	BPMR7A	4626	02 5959
SRM 400 / 400 U Serial # Prefix 03	0,60	BPM7A	7321	02 5959
SRM 402 DE / 4600, SRM 410 U Mot. 42.7cc	0,60	BPMR7A	4626	02 5959
SRM 1500 / 2000 / 2090	0,60	BPMR7A	4626	02 5959
SRM 2100 / 2100 SB	0,60	BPM7A	7321	02 5959
SRM 2200 / 2300	0,60	BPMR7A	4626	02 5959
SRM 2400 / 2400 SB / 2410 / 2450	0,60	BPM7A	7321	02 5959
SRM 2601	0,60	BPM7A	7321	02 5959
SRM 2605 / 2655 / 3000	0,60	BPMR7A	4626	02 5959
SRM 3001	0,70	BPMR7A	4626	02 5959
SRM 3010	0,60	BPMR7A	4626	02 5959
SRM 3100 / 3100 S, SRM 3110	0,60	BPM7A	7321	02 5959
SRM 3150 / 3155	0,60	BPMR7A	4626	02 5959
SRM 3400	0,60	BPM7A	7321	02 5959
SRM 3500 / 3550 / 3600 / 3605	0,60	BPMR7A	4626	02 5959

Modèle		N°		
		STOCK	BLISTER	STOCK
		BOÎTE	BLISTER	BLISTER
SRM 3800	0,60	BPM7A	7321	02 5959
SRMB 16AE	0,70	BPMR7A	4626	02 5959
SRMB 2301 (21S)	0,60	BPMR7A	4626	02 5959
SRMB 2502 (25S) / 3001 (30S) / 3800 (38B)	0,60	BPMR7A	4626	02 5959
SRMR 200DE	0,70	BPMR7A	4626	02 5959
WT 190S & 1190T Mot. 190cc B&S	0,50	BKR5E	2460	07 4803

ECHO - Générateurs

CLS 4600 / 4610	0,60	BPM7A	7321	02 5959
CS 3400	0,60	BPMR7A	4626	02 5959
CS 4200	0,60	BPM6Y	4562	- -
CS 5100	0,60	BPM8Y	2057	- -
CS 6701-40	0,60	BPM7A	7321	02 5959
CSG 6700	0,60	BPM6A	7021	08 5063
DM 9 / 9A / 9M	0,70	BM6A	5921	01 5478
DM 3500 / 4100 / 4500	0,60	BMR6A	7421	01 5478
DM 4600 / 4610 / 5500 / 6100 / 6110	0,60	BPMR7A	4626	02 5959
ECE 600B	0,60	BPM6A	7021	08 5063
EG 550, EG 650 (-93)	0,60	BPM4A	5928	- -
EG 650 (94-)	0,60	BMR4A	5728	- -
EG 750	0,60	BPM4A	5928	- -
EG 1200	0,60	BR6HS	3922	- -
EG 1500	0,60	BPR4HS	7823	- -
EG 1800	0,70	BM6A	5921	01 5478
EG 2300, EG 2400 (-93)	0,60	BPR4HS	7823	- -
EG 2400 (94-)	0,60	BR6HS	3922	- -
EG 2600	0,60	BMR4A	5728	- -
EG 3500	0,60	BPM4A	5928	- -
EG 3501 (-93)	0,60	BPR4HS	7823	- -
EG 3501 (94-)	0,70	BPR6HS	7022	- -
EG 4300 / 4300 E	0,50	BPR4HS	7823	- -
EG 460, EG 4601	0,70	BKR5E	7938	07 4803
EG 5500 E	0,50	BPR4HS	7823	- -
EG 5600 E, EG 5601, EG 7600 E, EG 7601	0,70	BKR5E	7938	07 4803
EG 7600 E / EG 7601	0,70	BKR5E	7938	07 4803
ES 1000	0,60	BPM7A	7321	02 5959
ES 2000 / 2100 / 2400	0,60	BPM7Y	4921	- -
EY 28 P	0,60	BPR6HS	7022	- -
EY 40 D	0,60	BR6HS	3922	- -
F 3T	0,60	BM6A	5921	01 5478
FM 50A	0,60	B6S	3510	09 6048
FMD 3	0,60	AB-7	3010	- -
G 1AK, GE 200E	0,60	BM6A	5921	01 5478
GE 36 DGY / 50 DGY / 75 DGY / 90 DGY	0,60	BPM4A	5928	- -
HC 140 / 150i / 160 / 160A	0,60	BMR6A	7421	01 5478
HC 150 / 160 / 180 / 1500 / 1600 / 2000	0,60	BPMR7A	4626	02 5959
HC 200 / 200AE / 210E / 210AE, HC 1000 / 1001	0,60	BMR6A	7421	01 5478
HC 2100 / 2400, HCA 2400	0,60	BPMR7A	4626	02 5959
HCA 2410	0,60	BPM7Y	4921	- -
HCR 150	0,60	BPMR7A	4626	02 5959
HCR 1500	0,60	BPMR6A	6726	08 5063
HDTP 2001 / 3001	0,60	BR6HS	3922	- -
KE 140DA / 200DA	0,60	BM6A	5921	01 5478
KEC 340 / 400 / 440	0,60	B8HS	5510	- -
KED 160	0,60	B6S	3510	09 6048
KED 202E / 301E	0,60	BM6A	5921	01 5478
KED 50/2B	0,60	B-4H	4110	- -
MB 400	0,60	BM6A	5921	01 5478
Mot. B&S 5 hp / Kohler 8 hp	0,60	B2-LM	1147	06 4740
Mot. B&S Vanguard 9 / 11 hp	0,70	BKR5E	7938	07 4803
Mot. B&S Vanguard V-Twin 16 hp	0,70	BKR5E	7938	07 4803
Mot. Kohler OHV 14 hp	0,70	BKR5E	7938	07 4803
PB 9	0,60	BM6A	5921	01 5478
PB 24 LN / 46 LN	0,60	BPM7Y	4921	- -
PB 200 / 202 / 400 / 400E	0,60	BM6A	5921	01 5478
PB 210 E	0,60	BPM7A	7321	02 5959
PB 770	0,60	BPMR8Y	2218	- -
PB 1000 / 1010	0,60	BPM7A	7321	02 5959
PB 2100 / 2400 / 2405 / 4600 / 6000	0,60	BPM7Y	4921	- -
PB 300E / 4500	0,60	BPM7A	7321	02 5959
REC 600	0,60	BPM7A	7321	02 5959
RM 385	0,60	BPMR7A	4626	02 5959
SH 5BE, SH 202 E / 701 E	0,60	BM6A	5921	01 5478
SHC 2100 / 2401	0,60	BPMR7A	4626	02 5959
SHR 200E	0,60	BM6A	5921	01 5478
SHR 2100	0,60	BPM6Y	4562	- -

Modèle

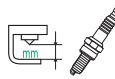
 N° STOCK BOÎTE
 N° BLISTER
 N° STOCK BLISTER

ECHO - Générateurs				
SHR 4100	0,60	BPMR6A	6726	08 5063
SRM 2015	0,60	BM6A	5921	01 5478
SRM 2100	0,60	BPM7A	7321	02 5959
SRM 2450 / 2455	0,60	BPM7Y	4921	- -
SRM 2605 / 3155	0,60	BPMR7A	4626	02 5959
SRM 3805 / 4605	0,60	BPM7A	7321	02 5959
TP 2001 / 3000 / 3001	0,60	BR6HS	3922	- -
WP 1000	0,60	BPM7A	7321	02 5959
WP 2000 / 2001 / 3000	0,60	BR6HS	3922	- -

ECHO - Outils Divers				
HC 1500	0,60	BPM6A	7021	08 5063
HC 1600 / 2300	0,60	BPM7A	7321	02 5959
PB 2455 / 6000	0,60	BPM7Y	4921	- -
WP 1000	0,60	BPM7A	7321	02 5959

ECHO - Tondeuses				
A-14 10.6 kW, A-16 12.1kW - Mot. B&S	0,70	BCPR5ES	6130	07 4803
A-18 13.2 kW - Mot. B&S	0,70	BCPR5ES	6130	07 4803
E-130G/HY, E-2000HY 8,5 kW - Mot. B&S	0,60	BR2-LM	5798	06 4740
E-150HY 11.1 kW - B&S	0,70	BCPR5ES	6130	07 4803
HO-13-93C 9,6kW - Mot. Honda	0,60	BPR5ES	7422	03 6854
LM-204, LM-204P, LM-214, LM-214P	0,70	BR2-LM	5798	06 4740
LM-212, LM-212P, LM-212PS, LMC-212	0,70	BPMR6A	6726	08 5063

ECHO - Tronçonneuses				
60S, 80Z, 100, 601, 801, 802, S290	0,60	BMR6A	7421	01 5478
280E, 290EVL, 300EVL	0,60	BPMR6A	6726	08 5063
280EP, 301, 302/S, 304	0,60	BMR6A	7421	01 5478
315, 330, 351VL, 451VL, 452VL	0,60	BMR6A	7421	01 5478
400EVL, 500EVL	0,60	BPMR6A	6726	08 5063
510EVL, 550EVL, 601EVL, 602VL	0,60	BPMR7A	4626	02 5959
601S, 601SVL, 602EVL	0,60	BMR6A	7421	01 5478
610EVL, 620VL	0,60	BPMR7A	4626	02 5959
650EVL, 701SVL / VL	0,60	BMR6A	7421	01 5478
650EVL, 660EVL / VL	0,60	BPMR7A	4626	02 5959
1001VL, 2800, 3000	0,60	BPMR7A	4626	02 5959
3400, 3450, 3900, 4000, 4400, 4500	0,60	BPMR7A	4626	02 5959
6700, 8000, 4600, 5000	0,60	BPMR7A	4626	02 5959
750EVL, 852EVL, 900EVL	0,60	BPMR7A	4626	02 5959
CLS-4610	0,60	BPM7A	7321	02 5959
CS-30EVL, CS-60S	0,60	BMR6A	7421	01 5478
CS-271T Mot. 26.9cc	0,60	BPM8Y	2057	- -
CS-280EG / EVL, CS-285EVL / 290EVL	0,60	BMR6A	7421	01 5478
CS-300, CS-300-14 Mot. 30.1cc (Série >02)	0,60	BPM8Y	2057	- -
CS-300, CS-300-14 Mot. 30.1cc (Série 04->)	0,60	BPMR8Y	2218	- -
CS-300EVL	0,60	BPMR6Y	5256	- -
CS-301 (Série >02-04-<)	0,60	BPM8Y	2057	- -
CS-301 (Série >03)	0,60	BPMR8Y	2218	- -
CS-303T Mot. 30.1cc	0,60	BPM8Y	2057	- -
CS-305 Mot. 30.1cc	0,60	BPMR8Y	2218	- -
CS-306	0,60	BPMR7A	4626	02 5959
CS-310 Mot. 30.5cc	0,60	BPM8Y	2057	- -
CS-320EVL / 330EVL	0,60	BMR6A	7421	01 5478
CS-330T Mot. 32.6cc	0,60	BPMR8Y	2218	- -
CS-332	0,60	BPMR7A	4626	02 5959
CS-340 Mot. 33.4cc	0,60	BPMR8Y	2218	- -
CS-341 Mot. 33.4cc	0,60	BPM8Y	2057	- -
CS-345 Mot. 33.4cc	0,60	BPMR8Y	2218	- -
CS-346 Mot. 33.4cc	0,60	BPM8Y	2057	- -
CS-351VL	0,60	BMR6A	7421	01 5478
CS-352 Mot. 34cc, CS-355T Mot. 35.8cc	0,60	BPM8Y	2057	- -
CS-360T Mot. 36.3cc	0,60	BPMR8Y	2218	- -
CS-370 Mot. 36.3cc, CS-400 Mot. 40.2cc	0,60	BPM8Y	2057	- -
CS-400EVL	0,60	BPM6A	7021	08 5063
CS-440 Mot. 43.6cc	0,60	BPMR8Y	2218	- -
CS-440EVL	0,60	BPMR7A	4626	02 5959
CS-450, CS-450P Mot. 45cc	0,60	BPM8Y	2057	- -
CS-451VL / 452VL	0,60	BMR6A	7421	01 5478
CS-500P Mot. 50.2cc	0,60	BPM8Y	2057	- -
CS-500VL / EVL	0,60	BPMR6A	6726	08 5063
CS-510 Mot. 49.3cc	0,70	BPM7A	7321	02 5959
CS-510EVL Mot. 49.3cc	0,60	BPMR7A	4626	02 5959

Modèle

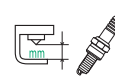
 N° STOCK BOÎTE
 N° BLISTER
 N° STOCK BLISTER

CS-520 Mot. 50.1cc, (Série >05)	0,60	BPM8Y	2057	- -
CS-520 Mot. 50.1cc, (Série >05-07-<)	0,70	BPM7A	7321	02 5959
CS-520 Mot. 50.1cc, (Série 07->)	0,60	BPMR8Y	2218	- -
CS-550	0,70	BPMR8Y	2218	- -
CS-550P Mot. 54.1cc	0,60	BPMR8Y	2218	- -
CS-590 Timber Wolf Mot. 59.8cc	0,60	BPM8Y	2057	- -
CS-600	0,60	BMR6A	7421	01 5478
CS-600P Mot. 59.8cc	0,60	BPM8Y	2057	- -
CS-601 / S / SVL / EVL	0,60	BMR6A	7421	01 5478
CS-602VL	0,60	BPMR7A	4626	02 5959
CS-620P, CS-620PW Mot. 59.8cc	0,60	BPM8Y	2057	- -
CS-650EVL / 660EVL	0,60	BPMR7A	4626	02 5959
CS-670 Mot. 66.7cc, (Série >03)	0,70	BPMR7A	4626	02 5959
CS-680 Mot. 66.8cc	0,70	BPM7A	7321	02 5959
CS-701 / VL / SVL	0,60	BMR6A	7421	01 5478
CS-702VL / 702EVL / 750VL / 750EVL	0,60	BPMR7A	4626	02 5959
CS-1001VL	0,60	BMR6A	7421	01 5478
CS-3000 / 3600 / 4000	0,60	BPM7A	7321	02 5959
CS-3400	0,70	BPM7A	7321	02 5959
CS-3450 / 5000	0,60	BPM7A	7321	02 5959
CS-3900	0,60	BPM6A	7021	08 5063
CS-4400 Mot. 43.6cc	0,60	BPM7A	7321	02 5959
CS-4500 / 4600 / 4601 / 5500 / 5501	0,60	BPM7A	7321	02 5959
CS-6700 Mot. 66.7cc	0,60	BPM7A	7321	02 5959
CS-6700 Mot. Type 1E	0,60	BPM8Y	2057	- -
CS-6701	0,60	BPM7A	7321	02 5959
CS-8000 Mot. 80.7cc	0,60	BPM7A	7321	02 5959
CS-900EVL, CSO-1200, CST-600EVL	0,60	BPMR7A	4626	02 5959
HC-160 / -210 / -1000 / -1500	0,60	BM6A	5921	01 5478
QV-670 / 675 / 6750 Mot. 66.7cc, (Série >03)	0,70	BPM7A	7321	02 5959
QV-670 / 675 / 6750 Mot. 66.7cc, (Série 04->)	0,70	BPMR7A	4626	02 5959
QV-6700 Mot. 66.7cc	0,60	BPM8Y	2057	- -
QV-8000 / 8050 Mot. 80.7cc	0,70	BPM7A	7321	02 5959

ECLIPSE - Tondeuses				
Tous modèles	0,50	BR2-LM	5798	06 4740

ECONOMY - Tondeuses				
Mot. Kohler K321 14 hp	0,80	B-6L	3212	- -

EDKO - Débroussailleuses				
Convertible Till-Trac	0,70	BMR6A	7421	01 5478
Débroussailleuse	0,60	BM6A	5921	01 5478

EDKO - Générateurs				
Tous modèles	0,60	BMR6A	7421	01 5478

EDKO - Tondeuses				
Tous modèles	0,50	BR2-LM	5798	06 4740
WalkingTractor	0,60	BM6A	5921	01 5478

EFCO - Débroussailleuses				
8200, 8220 / IC, 8250 / IC / ICD, 8260 / IC / (D)	0,60	BPMR7A	4626	02 5959
8260 Stark 26, 8300 / IC, 8350 / IC, 8355	0,60	BPMR7A	4626	02 5959
8400 / IC, 8405, 8420 / IC, 8425, 8460 / IC	0,60	BPMR7A	4626	02 5959
8465, 8550 Boss, 8510 / IC, 8515, 8530 / IC	0,60	BPMR7A	4626	02 5959
8535 Ergo Mot. Emak	0,70	BPMR7A	4626	02 5959
DS 2200 S / 2400 S / 2400 T Mot. Emak	0,70	CMR7H	3066	- -
DS 2400 D Euro 2 Mot. Emak	0,70	CMR7H	3066	- -
DS 2500	0,50	CMR7H	3066	- -
DS 2600 4S Mot. Emak	0,70	CMR5H	7599	- -
DS 2800 S Mot. Emak	0,70	CMR7A	7543	- -
DS 2800, DS 3200	0,50	CMR7A	7543	- -
DS 3200 S / T Mot. Emak	0,70	CMR7A	7543	- -
DS 3500 S / T Mot. Emak	0,70	BPMR7A	4626	02 5959
DS 3600 4T Mot. Emak	0,70	CMR5H	7599	- -
DS 3800 T Mot. Emak	0,70	BPMR7A	4626	02 5959
DS 3800, DS 4200	0,60	BPMR7A	4626	02 5959
DS 4300 T / DSF 4200 Mot. Emak	0,70	BPMR7A	4626	02 5959
HC 1500	0,60	BPM6A	7021	08 5063
HC 160A / 210E / 1000 / 1600	0,60	BM6A	5921	01 5478
Jet 200, 220, 260 / D, 261, 300	0,50	BPM7A	7321	02 5959
Jet 310 / 400 / 410 / 450AVS / 460	0,70	BPMR7A	4626	02 5959

Modèle

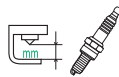

N° STOCK BOÎTE
N° BLISTER
N° BLISTER

Jet 8420 / 8510	0,50	BPM7A	7321	02	5959
Stark 25, 26 / IC / TR, 37, 42, 3700	0,50	BPMR7A	4626	02	5959
Stark 25 T Mot. Emak	0,70	BPMR6A	6726	08	5063
Stark 42 BP Mot. Emak	0,70	BPMR7A	4626	02	5959
Stark 2500 S 3D / 2500 T Mot. Emak	0,70	BPMR8Y	2218	-	-
Stark 2500 TR Mot. Emak	0,50	BPMR8Y	2218	-	-
Stark 3800 T / 4400 T Mot. Emak	0,70	BPMR7A	4626	02	5959
Tiger 40 / S, 50, TS 330 / 355	0,50	BPMR7A	4626	02	5959

EFCO - Générateurs

171 / 181, 8400 IC, AT 2050 / 2080	0,60	BPM7A	7321	02	5959
E 8405BP, HT 27	0,60	BPMR7A	4626	02	5959
MP 3000 - Mot. Emak	0,60	BMR7A	4226	10	6793
PA 1030 / 1040	0,60	BPM7A	7321	02	5959
PA 1050 / 1100 - Mot. Emak	0,60	BPMR6A	6726	08	5063
Séries 8260 / 8320 / 8350 / 8420 / 8460 / 8510	0,60	BPMR7A	4626	02	5959
Séries 8725 / 8726 / 8735 / 8740 / 8742 / 8746	0,60	BPMR7A	4626	02	5959
Stark 26 TR	0,60	BPM7A	7321	02	5959
TR 1540	0,60	BPMR7A	4626	02	5959
TR 1581 R, TS 326 / 326 S	0,60	BPM7A	7321	02	5959
TS 330	0,60	BPMR7A	4626	02	5959
TS 355	0,60	BPM7A	7321	02	5959

EFCO - Manutention

TN 2700 K - Mot. Emak K650 OHV	0,80	BKR6E	6962	-	-
TN 2700H - Mot. Honda GCV135	0,80	BPR6ES	7822	04	7678
TN4500 3MA+1RM - Mot. Honda GX160 OHV	0,80	BPR5ES	7422	03	6854
TN5600 4MA+2RM - Mot. Honda GX160 OHV	0,80	BPR5ES	7422	03	6854

EFCO - Outils Divers

100 Pro Sweep H Mot. Honda GX 160 OHV	0,80	BPR5ES	7422	03	6854
70 / 80 Easy Sweep H Mot. Honda GC 135 OHV	0,90	BPR6ES	7822	04	7678
85 Radial Sweep H Mot. Honda GX 160 OHV	0,80	BPR5ES	7422	03	6854
AT 2062 Mot. Emak	0,70	BPMR6A	6726	08	5063
AT 8000 / IS 2026 / Multimate Mot. Emak	0,70	BPMR7A	4626	02	5959
SA 2062 / 2700 / 2700 BP / 3000 Mot. Emak	0,70	BPMR6A	6726	08	5063
STG 1170E - Artik 70 ELD Mot. Loncin 302cc	0,80	BPR7ES	2023	-	-
STG 8062 - Artik 62 ELD Mot. Loncin 265cc	0,80	BPR7ES	2023	-	-
TR 1551 Mot. Emak	0,70	BPMR6A	6726	08	5063
TR 1585R Mot. Emak	0,70	BPMR8Y	2218	-	-
ZLST 401Q - Artik 52 Mot. Loncin	0,80	BPR7ES	2023	-	-
ZLST 551Q - Artik 56 Mot. Loncin 182cc	0,80	BPR7ES	2023	-	-
ZLST 651QE - Artik 56 EL Mot. Loncin 212cc	0,80	BPR7ES	2023	-	-

EFCO - Tondeuses

AR 38-AR / 2 - Mot. B&S	0,60	BR2-LM	5798	06	4740
AR 47-AH 3/2 - Mot. Honda	0,60	BPR6ES	7822	04	7678
AR 48 PBQ / TBX / TBXE / VBX - Mot. B&S	0,60	BR2-LM	5798	06	4740
AR 53 PAL / TAL / TALV - Mot. Tecumseh	0,50	BR2-LM	5798	06	4740
AR 53 PB / PBV / TB / TBX / TBXE / VBX - Mot. B&S	0,50	BR2-LM	5798	06	4740
AR 53 THX / 60-AH 1/2 - Mot. Honda	0,70	BPR6ES	7822	04	7678
EF 72C 13 H B&S Pow. Built 3130 AVS 13hp	0,90	BKR5E	7938	07	4803
EF 72C/12,5K H Mot. Emak K1250 AVD	0,90	BKR5E	7938	07	4803
LR 43 PA - Mot. Tecna 3.5 hp	0,70	BR4-LM	4133	05	4358
LR 43 PA Mot. Tecumseh	0,50	BR2-LM	5798	06	4740
LR 43 PB / LR 47 PB - Mot. B&S 3.8 hp	0,50	BR2-LM	5798	06	4740
LR 44 P / PBX - Mot. B&S	0,60	BR2-LM	5798	06	4740
LR 47 PA / PAL / PAX - Mot. Tecna 3.7 hp	0,70	BR4-LM	4133	05	4358
LR 47 PA / PAL / PAX / Mot. Tecumseh	0,50	BR2-LM	5798	06	4740
LR 47 PBQ / PBX - Mot. B&S	0,50	BR2-LM	5798	06	4740
LR 47 PHQ / THQ - Mot. Honda	0,60	BPR6ES	7822	04	7678
LR 47 TA / TAL / TAX - Mot. Tecumseh	0,50	BR2-LM	5798	06	4740
LR 47 TB / TBQ / TBX - Mot. B&S	0,50	BR2-LM	5798	06	4740
LR 48 PBQ / PBX / TBQ / TBX / TBXE - Mot. B&S	0,60	BR2-LM	5798	06	4740
LR 48 TH - Mot. Honda	0,60	BPR6ES	7822	04	7678
LR 48 TK - Mot. Emak	0,80	BKR6E	6962	-	-
LR 53 PBX / TBX Mot. B&S	0,50	BR2-LM	5798	06	4740
LR 53 TBX Cornfort Mot. B&S	0,70	BR2-LM	5798	06	4740
LR 53 THX Mot. Honda	0,60	BPR6ES	7822	04	7678
LR 53 VBD Allroad Plus4 Mot. B&S 750	0,80	BCP5ES	7496	07	4803
MR 474 PB / TB / TP / TBV - Mot. B&S	0,50	BR2-LM	5798	06	4740
MR 474 TK, 534 TK - Mot. Kawasaki	0,60	BPR6ES	7822	04	7678
MR 534 TB / TBE / TBV / TBVE / TBVI - Mot. B&S	0,50	BR2-LM	5798	06	4740
MR 534 THV / THVX Mot. Honda	0,60	BPR6ES	7822	04	7678

Modèle

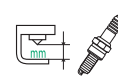

N° STOCK BOÎTE
N° BLISTER
N° BLISTER

MR 534 TKV / TKF / TKVF - Mot. Kawasaki	0,60	BPR5ES	7422	03	6854
Storm 97/13,5T B&S Pow. Built 3130 AVS 13hp	0,90	BKR5E	7938	07	4803

EFCO - Tronçonneuses

131 / 134 / 135 / 136 / 138	0,60	BPMR7A	4626	02	5959
132 S-30cm Mot. Emak, 132 S-35cm Mot. Emak	0,70	BPMR6A	6726	08	5063
140 / 140S / 141 / 142 / 146	0,60	BPMR7A	4626	02	5959
147-41cm 325' Mot. Emak	0,70	BPMR7A	4626	02	5959
151 / 156 / 162 / 170 / 180 / 199	0,60	BPMR7A	4626	02	5959
152-46cm Mot. Emak	0,70	BPMR7A	4626	02	5959
162-51cm Mot. Emak	0,70	BPMR6A	6726	08	5063
935 / 940 / 951 / 956 / 962C / 971 / 981	0,60	BPMR7A	4626	02	5959
DS 2400 H Mot. Emak	0,70	CMR7H	3066	-	-
DS 2800H Mot. Emak	0,70	CMR7A	7543	-	-
EF MT 3500 S 3/8" Mot. Emak	0,70	BPMR6A	6726	08	5063
MT 2600-25cm & MT 3500-35cm Mot. Emak	0,70	BPMR6A	6726	08	5063
MT 3700-35cm Mot. Emak	0,70	BPMR7A	4626	02	5959
MT 3700-41cm Power Sharp 3/8 Mot. Emak	0,70	BPMR7A	4626	02	5959
MT 4100 S / 4100 SP -41cm Mot. Emak	0,70	BPMR7A	4626	02	5959
MT 440 / 4400-41cm Mot. Emak	0,70	CMR7A	7543	-	-
MT 5200 - 46cm Mot. Emak	0,70	BPMR7A	4626	02	5959
MT 6500 / 7200 -51cm Mot. Emak	0,70	BPMR8Y	2218	-	-
MT 8200-64cm Mot. Emak	0,70	BPMR8Y	2218	-	-
PT2500 / PTX2500 Mot. Emak	0,70	BPMR7A	4626	02	5959
PTX2700 Mot. Emak	0,70	CMR7A	7543	-	-
TG 2600XP / 2650XP / 2800XP Mot. Emak	0,70	BPMR7A	4626	02	5959
TGS 2800XP Mot. Emak	0,70	BPMR7A	4626	02	5959
TT163-12' Mot. Emak, TT163 14" Mot. Emak	0,70	BPMR8Y	2218	-	-
TT183-14' Mot. Emak, TT183 16" Mot. Emak	0,70	BPMR8Y	2218	-	-

EINHELL - Débroussailleuses

MT 24 / MTK 24	0,60	BPMR7A	4626	02	5959
----------------	------	---------------	-------------	-----------	-------------

ELITE - Tronçonneuses

Mot. B&S Vanguard 9 hp	0,80	BKR5ES	2460	07	4803
Mot. Honda 9 / 11 / 13 hp	0,80	BPR5ES	7422	03	6854
Mot. Onan OHV 12.5 hp, Mot. Robin 11 hp	0,70	BPR4HS	7823	-	-
Mot. Robin 9 hp	0,60	BPMR6A	6726	08	5063

ELWELL-PARKER - Manutention

Continental	0,60	AB-6	2910	-	-
-------------	------	-------------	-------------	---	---

ERICKSON - Manutention

1237 - Continental	0,60	AB-6	2910	-	-
E-Z Loader	0,60	B6S	3510	09	6048
F5W, F7, Front End Loader	0,60	AB-6	2910	-	-
MCH, Platform Truck, Powerkart, Rack Runner	0,60	AB-6	2910	-	-

ERING - Outils Divers

5PS RX, MHH 15	0,50	BR2-LM	5798	06	4740
T 102155 H, T 10217 H, T 106155 S	0,70	BKR5ES	2460	07	4803
T 7613 H, T 9612 S	0,50	BR2-LM	5798	06	4740

ERING - Tondeuses

A 440 H / HV, A 443 H, A 448 H / HV / H-ZH / S	0,70	B4-LM	3410	05	4358
ABA 448 H	0,50	BR2-LM	5798	06	4740
AH 453 H Alu, BH 448 H Alu, CO A 448 S HV	0,70	B4-LM	3410	05	4358
G4-87	0,50	BR2-LM	5798	06	4740
GAN 3748 H ZH	0,70	B4-LM	3410	05	4358
GAN 4045 HI ZH, GT B 4840 P / 4850 T / 5350 ES	0,50	BR2-LM	5798	06	4740
GT B 5350 T, H 3581 / 448 H HV	0,50	BR2-LM	5798	06	4740
Mot. Aspera, Mot. B&S	0,50	B4-LM	3410	05	4358
Muko A 448 H-ZH, R 7608 S / 7612 S, T 1012 S	0,70	B4-LM	3410	05	4358
T 3581	0,50	BR2-LM	5798	06	4740
T 4, Traktor 14PS, VBT-40	0,70	B4-LM	3410	05	4358
VBT-40 H	0,50	BR2-LM	5798	06	4740

ESKA - Tondeuses

Tous modèles	0,50	BR2-LM	5798	06	4740
--------------	------	---------------	-------------	-----------	-------------

Modèle

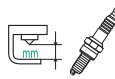
 N° STOCK BLISTER
 N° BOÎTE
 N° BLISTER

ESTATE TRIMMER - Débroussailleuses

Mot. B&S 4 / 5 hp	0,70	BR2-LM	5798	06	4740
Mot. B&S Intek OHV 6 hp	0,70	BKR5E	7938	07	4803

ESTATE TRIMMER - Tondeuses

Mot. B&S 12.5 hp	0,70	BR2-LM	5798	06	4740
------------------	------	---------------	-------------	-----------	-------------

EVERRIDE - Tondeuses

Hornet - Mot. Kawa. FH601V 19hp / FH680V 23hp	0,70	BPR4ES	7222	-	-
Mot. Kawa. V-Twin 4 tps OHV 19 / 23 / 25 hp	0,80	BPR5ES	7422	03	6854
Mot. Kawasaki V-Twin (Refruid Liq.) 27 hp	0,80	BPR2ES	2264	-	-
Mot. Kohler V-Twin (Refr. Air) 4 tps OHV 27hp	0,80	BKR5E	7938	07	4803
Scorpion - Mot. Kohler OHV 23 hp	0,70	BKR5ES	2460	07	4803
Warrior - Mot. Kawasaki FH721V 25 hp	0,70	BPR4ES	7222	-	-
Warrior - Mot. Kohler Command Pro 30 hp	0,70	BKR5ES	2460	07	4803
Warrior - Mot. Kohler CV740 27 hp	0,60	BPR2ES	2264	-	-
Wasp - Mot. Kawasaki FH430 15 hp	0,90	BCPR6ES	2330	-	-
Wasp - Mot. Kawasaki FH541V 17 hp	0,60	BPMR6A	6726	08	5063

EVERSHARP - Tondeuses

Tous modèles	0,50	BR2-LM	5798	06	4740
--------------	------	---------------	-------------	-----------	-------------

EXCELLO - Tondeuses

Mot. Power Product	0,70	BR6S	3522	09	6048
--------------------	------	-------------	-------------	-----------	-------------

EXMARK - Tondeuses

Comm. 21X (ECXHNBC21) Honda GXV160	0,70	BPR5ES	7422	03	6854
Comm. 21X (ECXKABBC21) Kawa FJ180V KAI	0,80	BPR5ES	7422	03	6854
Commercial 21S (ECSKA21) Kawa. FJ180V	0,80	BPR5ES	7422	03	6854
Commercial 21X (ECXHN21) Honda GXV160	0,70	BPR5ES	7422	03	6854
Commercial 21X (ECXK21) Kawa. FJ180V KAI	0,80	BPR5ES	7422	03	6854
Commercial 30 Mot. Kawasaki FJ180V KAI	0,80	BPR5ES	7422	03	6854
LazerZ S21(LZS749EKC604) Kohler ECV749	0,70	BKR5ES	2460	07	4803
LazerZ S21(LZS749EKC724) Kohler ECV749	0,70	BKR5ES	2460	07	4803
LazerZ S21(LZS801KA524) Kawa. FX801V	0,80	BPR4ES	7222	-	-
LazerZ S21(LZS801KA604) Kawa. FX801V	0,80	BPR4ES	7222	-	-
LazerZ S21(LZS801KA724) Kawa. FX801V	0,80	BPR4ES	7222	-	-
LazerZ X21(LZX801KA606) Kawa. FX801V	0,80	BPR4ES	7222	-	-
LazerZ X21(LZX940EKC606) Kohler ECV940	0,70	BKR6E	6962	-	-
LazerZ X21(LZX980EKC726) Kohler ECV980	0,70	BKR6E	6962	-	-
LazerZ X21(LZX980KC606) Kohler CV980	0,70	BKR5ES	2460	07	4803
LazerZ X21(LZX980KC726) Kohler CV980	0,70	BKR5ES	2460	07	4803
LazerZ E21(LZE600KA484) Kawa. FX600V	0,80	BPR4ES	7222	-	-
LazerZ E21(LZE691KA524) Kawa. FR691V	0,80	BPR4ES	7222	-	-
LazerZ E21(LZE730KA604) Kawa FX730V	0,80	BPR4ES	7222	-	-
LazerZ E21(LZE740EKC604) Kohler CV740	0,70	BKR5ES	2460	07	4803
LazerZ Prop. (LZS740PKC604) Kohler PCV740	0,70	BKR5ES	2460	07	4803
LazerZ Propane (LZS740) Kohler PCV740	0,70	BKR5ES	2460	07	4803
LazerZ S21(LZS651KA484) Kawa FX651V	0,80	BPR4ES	7222	-	-
LazerZ S21(LZS691KA524) Kawa FS691V	0,80	BPR4ES	7222	-	-
LazerZ S21(LZS740PKC604) Kohler PCV740	0,70	BKR5ES	2460	07	4803
LazerZ S21(LZS740PKC724) Kohler PCV740	0,70	BKR5ES	2460	07	4803
LazerZ X21(LZX740EKC526) Kohler ECV740	0,70	BKR5ES	2460	07	4803
Metro (MG481KA322P) Mot. Kawa. FS481V	0,80	BPR4ES	7222	-	-
Metro (MG481KA362) Mot. Kawa. FS481V	0,80	BPR4ES	7222	-	-
Metro (MG481KA362CA) Mot. Kawa. FS481V	0,80	BPR4ES	7222	-	-
Metro (MG481KA483) Mot. Kawa. FS481V	0,80	BPR4ES	7222	-	-
Metro (MG481KA483CA) Mot. Kawa. FS481V	0,80	BPR4ES	7222	-	-
Mot. B&S 18 hp, Mot. B&S (3 Cyl.) 31 hp	0,70	BKR5ES	2460	07	4803
Mot. B&S Intek 14 / 15.5 / 17 hp	0,90	BKR5E	7938	07	4803
Mot. B&S OHV 6.5 hp	0,80	BKR5E	7938	07	4803
Mot. Honda 5.5 hp	0,70	BPR6ES	7822	04	7678
Mot. Kawa. V-Twin (Refr. Liquide) 17 hp	0,60	BPR2ES	2264	-	-
Mot. Kawasaki 5.5 / 6 hp	0,70	BPR5ES	7422	03	6854
Mot. Kawasaki Monocylindre 13.5 hp	0,80	BPR5ES	7422	03	6854
Mot. Kawasaki V-Twin 15 hp	0,60	BCPR6ES	2330	-	-
Mot. Kawasaki V-Twin 17 hp	0,70	BPMR6A	6726	08	5063
Mot. Kohler Command 18 / 20 / 23 / 25 / 27 / 28 hp	0,70	BKR5ES	2460	07	4803
Mot. Kohler Command SP 15 hp	1,00	BKR5ES-11	2382	-	-
Navigator (NV640KC42) Mot. Kohler CH640	0,70	BKR5ES	2460	07	4803
Navigator (NV640KC48) Mot. Kohler CH640	0,70	BKR5ES	2460	07	4803
Navigator (NV730EKC48) Mot. Kohler ECH730	0,70	BKR5ES	2460	07	4803

Modèle

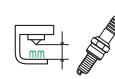
 N° STOCK BLISTER
 N° BOÎTE
 N° BLISTER

Pioneer E (PNE651KA482) Kawa. FR651V	0,80	BPR4ES	7222	-	-
Pioneer S (PNS600KA443) Kawa. FX600V	0,80	BPR4ES	7222	-	-
Pioneer S (PNS651KA483) Kawa. FR651V	0,80	BPR4ES	7222	-	-
Pioneer E (PNE691KA522) Kawa. FR691V	0,80	BPR4ES	7222	-	-
Pioneer S (PNS680KC523) Kohler CV680	0,70	BKR5ES	2460	07	4803
Pioneer S (PNS740KC604) Kohler CV740	0,70	BKR5ES	2460	07	4803
Quest E (QTE691KA501) Kawa. FR691V	0,80	BPR4ES	7222	-	-
Quest E (QTE651KA421) Kawa. FR651V	0,80	BPR4ES	7222	-	-
Quest S-Series Mot. Kawa. FR691V	0,80	BPR4ES	7222	-	-
Turf Tracer (TTS481KA363) Kawa. FS481V	0,80	BPR4ES	7222	-	-
Turf Tracer (TTS481KA363CA) Kawa FS481V	0,80	BPR4ES	7222	-	-
Turf Tracer (TTS481KA483) Kawa. FS481V	0,80	BPR4ES	7222	-	-
Turf TracerS Kohler PCV680 Propane	0,70	BKR5ES	2460	07	4803
Turf TracerS TTS541KA483CA Kawa FS541V	0,80	BPR4ES	7222	-	-
Turf TracerS TTS541KA523 Kawa FS541V	0,80	BPR4ES	7222	-	-
Turf TracerS TTS600KAE523 Kawa FS600V	0,80	BPR4ES	7222	-	-
Turf TracerS TTS600KAW483 Kawa FS600V	0,80	BPR4ES	7222	-	-
Turf TracerS TTS680PKCE483 Kohler PCV680	0,70	BKR5ES	2460	07	4803
Turf TracerX TTX650EKCE524 Kohler ECV650	0,70	BKR5ES	2460	07	4803
Turf TracerX TTX650EKCE604 Kohler ECV650	0,70	BKR5ES	2460	07	4803
Turf TracerX TTX650EKCE604N Kohl. ECV650	0,70	BKR5ES	2460	07	4803
Turf TracerX TTX680PKCE524 Kohler PCV680	0,70	BKR5ES	2460	07	4803
Turf TracerX TTX680PKCE524 Kohler PCV680	0,70	BKR5ES	2460	07	4803
Turf TracerX TTX680PKCE604 Kohler PCV680	0,70	BKR5ES	2460	07	4803
Turf TracerX TTX680PKCE604 Kohler PCV680	0,70	BKR5ES	2460	07	4803
Turf TracerX TTX691KAE524 Kawa. FX691V	0,80	BPR4ES	7222	-	-
Turf TracerX TTX691KAE604 Kawa. FX691V	0,80	BPR4ES	7222	-	-
Turf TracerX TTX691KAE604CA Mot. FX691V	0,80	BPR4ES	7222	-	-
Vantage S (VTS541KA363) Kawa. FS541V	0,80	BPR4ES	7222	-	-
Vantage S (VTS541KA363CA) Kawa FS541V	0,80	BPR4ES	7222	-	-
Vantage S (VTS651KA484) Kawa. FX651V	0,80	BPR4ES	7222	-	-
Vantage S (VTS691KA484CA) Kawa FX691V	0,80	BPR4ES	7222	-	-
Vantage S (VTS691KA524) Kawa. FX691V	0,80	BPR4ES	7222	-	-
Vantage S (VTS691KA624CA) Kawa FX691V	0,80	BPR4ES	7222	-	-
Vantage X (VTX651KA484) Kawa. FS651V	0,80	BPR4ES	7222	-	-
Vantage X (VTX691KA524) Kawa. FX691V	0,80	BPR4ES	7222	-	-
Vantage X (VTX730EKC524) Kohler ECV730	0,70	BKR5ES	2460	07	4803
Vantage X (VTX740EKC604) Kohler ECV740	0,70	BKR5ES	2460	07	4803
Viking (VH481KA362) Mot. Kawa. FS481V	0,80	BPR4ES	7222	-	-
Viking (VH481KA362CA) Mot. Kawa. FS481V	0,80	BPR4ES	7222	-	-
Viking (VH481KA483) Mot. Kawa. FS481V	0,80	BPR4ES	7222	-	-

EXPERT - Tondeuses

Tous modèles	0,50	BR2-LM	5798	06	4740
--------------	------	---------------	-------------	-----------	-------------

E-Z MO - Tondeuses

Mot. B&S 8.5 hp & Autres modèles	0,50	BR2-LM	5798	06	4740
----------------------------------	------	---------------	-------------	-----------	-------------

E-Z ROLL - Tondeuses

Mot. B&S	0,50	BR2-LM	5798	06	4740
Mot. Tecumseh	0,70	BR6S	3522	09	6048

F&N - Tondeuses

Tous modèles	0,70	BR2-LM	5798	06	4740
--------------	------	---------------	-------------	-----------	-------------

F.M.C. - Tondeuses

Autres Mot. Tecumseh	0,70	BR6S	3522	09	6048
Mot. B&S	0,70	BR2-LM	5798	06	4740
Mot. Tecumseh HH / OH Series	0,70	BR6HS	3922	-	-
Mot. Wisconsin	0,60	AB-6	2910	-	-

FAIRBANKS MORSE - Tondeuses

Tous modèles	0,70	BR2-LM	5798	06	4740
--------------	------	---------------	-------------	-----------	-------------

FALLS ROTO CLIPPER - Tondeuses

Autres modèles	0,70	BR2-LM	5798	06	4740
Mot. Power Product	0,80	BMR6A	7421	01	5478

FARMER - Tronçonneuses

F55 / F55A / F65	0,70	BM7A	6521	10	6793
------------------	------	-------------	-------------	-----------	-------------

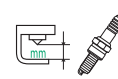
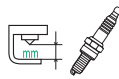
FEDWAY - Tondeuses

Mot. B&S	0,70	BR2-LM	5798	06	4740
Mot. Iron Horse	0,60	B-4	3210	-	-

FERRIS - Débroussailleuses

Mot. B&S 13 hp	0,70	BKR5ES	2460	07	4803
Mot. Honda GX390 13 hp	0,80	BPR6ES	7822	04	7678

FERRIS - Tondeuses

CCWKAV1536 Mot. Kawa. FS541V 15hp	0,80	BPR4ES	7222	-	-
CCWKAV2148 Mot. Kawa. FX651V 20.5hp	0,80	BPR4ES	7222	-	-
CCWKAV2152 Mot. Kawa. FX651V 20.5hp	0,80	BPR4ES	7222	-	-
CCWKAV2452 Mot. Kawa. FX730V 23.5hp	0,80	BPR4ES	7222	-	-
CCWKAV2461 Mot. Kawa. FX730V 23.5hp	0,80	BPR4ES	7222	-	-
EVKAV1936 Mot. Kawa. FH580V 19hp	0,70	BPMR6A	6726	08	5063
EVKAV2048 Mot. Kawa. FX600V 20hp	0,80	BPR4ES	7222	-	-
EVKAV2652 Mot. Kawa. FX730V 26hp	0,80	BPR4ES	7222	-	-
EVKAV2748 Mot. Kawa. FX751V 27hp	0,80	BPR4ES	7222	-	-
F800XBV31 Mot. B&S Vanguard 31hp	0,70	BKR5ES	2460	07	4803
HC32KAV15E Mot. Kawa. FS541V 15hp	0,80	BPR4ES	7222	-	-
HC36KAV15E Mot. Kawa. FS541V 15hp	0,80	BPR4ES	7222	-	-
IS200ZKAV2652 Mot. Kawa. FX801V 25.5hp	0,80	BPR4ES	7222	-	-
IS500ZB2444 Mot. B&S Profess. Series 24hp	0,70	BKR5ES	2460	07	4803
IS500ZB2752 Mot. B&S Profess. Series 27hp	0,70	BKR5ES	2460	07	4803
IS500ZB2761 Mot. B&S Profess. Series 27hp	0,70	BKR5ES	2460	07	4803
IS600ZB2744 Mot. B&S Profess. Series 27hp	0,70	BKR5ES	2460	07	4803
IS600ZB2748 Mot. B&S Profess. Series 27hp	0,70	BKR5ES	2460	07	4803
IS600ZKAV1944 B&S Comm. Turf Series 26hp	0,70	BKR5ES	2460	07	4803
IS600ZKAV1948 Mot. Kawa. FS600V 18.5hp	0,80	BPR4ES	7222	-	-
IS700KAV2461 Mot. Kawa. FS730V 24hp	0,80	BPR4ES	7222	-	-
IS700ZB2852 Mot. Kawa. FX801V 25.5hp	0,80	BPR4ES	7222	-	-
IS700ZB2861 Mot. Kawa. FX801V 25.5hp	0,80	BPR4ES	7222	-	-
IS700ZKAV2352 Mot. Kawa. FS691V 23hp	0,80	BPR4ES	7222	-	-
IS700ZXB2652 Mot. Vanguard Big Block 28hp	0,70	BKR5ES	2460	07	4803
IS1500KAV1948 Mot. Kawa. FS600V 18.5hp	0,80	BPR4ES	7222	-	-
IS1500ZB2644 B&S Comm. Turf Series 26hp	0,70	BKR5ES	2460	07	4803
IS1500ZB2648 B&S Comm. Turf Series 26hp	0,70	BKR5ES	2460	07	4803
IS1500ZCKAV2461 Mot. Kawa. FS730V 24hp	0,80	BPR4ES	7222	-	-
IS1500ZKA1944 Mot. Kawa. FS600V 18.5hp	0,80	BPR4ES	7222	-	-
IS1500ZXB2652 B&S Comm. Turf Series 26hp	0,70	BKR5ES	2460	07	4803
IS1500ZXB2861 B&S Comm. Turf Series 28hp	0,70	BKR5ES	2460	07	4803
IS1500ZXKAV2352 Mot. Kawa. FS691V 23hp	0,80	BPR4ES	7222	-	-
IS2000ZBH2852 B&S Comm. Turf Series 28hp	0,70	BKR5ES	2460	07	4803
IS2000ZKA2661 Mot. Kawa. FX801V 25.5hp	0,80	BPR4ES	7222	-	-
Mot. B&S 13 hp	0,70	BR2-LM	5798	06	4740
Mot. B&S 14 / 16 / 18 / 20 hp	0,80	BKR5E	7938	07	4803
Mot. B&S 31 hp	0,70	BKR5E	7938	07	4803
Mot. B&S Intek 13.5 hp, Mot. B&S Vanguard 20 hp	0,70	BKR5ES	2460	07	4803
Mot. Daihatsu 34 hp	0,80	BKR5E	7938	07	4803
Mot. Honda 13 hp	0,70	BPR6ES	7822	04	7678
Mot. Kawasaki 5 hp	0,70	BR6HS	3922	-	-
Mot. Kawasaki 13 / 14 / 17 hp	0,70	BPR5ES	7422	03	6854
Mot. Kawasaki 19 / 21 / 23 hp	0,70	BPR4ES	7222	-	-
Mot. Kawasaki 20 hp	0,80	BMR6A	7421	01	5478
Mot. Kawasaki FH721V 25 hp	0,70	BPR4ES	7222	-	-
Mot. Kawasaki OHV 13 / 14 / 17 hp	0,80	BPR5ES	7422	03	6854
Mot. Kawasaki OHV 21 / 23 / 25 hp	0,90	BPR5ES-11	4424	-	-
Mot. Kawasaki V-Twin 13 / 15 hp	0,60	BCPR6ES	2330	-	-
Mot. Kawasaki V-Twin 19 / 21 hp	0,70	BPR4ES	7222	-	-
Mot. Kawasaki V-Twin 26 hp	0,60	BPR2ES	2264	-	-
Mot. Kohler 12.5 / 14 / 15 / 20 / 22 / 23 hp	0,80	BKR5E	7938	07	4803
Mot. Kohler 25 / 27 hp	0,70	BKR5ES	2460	07	4803
Mot. Kohler Command 23 hp	0,70	BKR5ES	2460	07	4803
Mot. Kohler Command Pro V-Twin OHV 26 hp	0,70	BKR5ES	2460	07	4803
Mot. Kohler Command V-Twin 27 / 30 hp	0,70	BKR5ES	2460	07	4803
Mot. Kohler CV22 22 hp	0,70	BKR5ES	2460	07	4803
Mot. Kohler CV25 V-Twin 25 hp	0,70	BKR5ES	2460	07	4803
Mot. Kohler FD750D 27 hp	1,10	PGR5A-11	3573	-	-
Mot. Kohler OHV Twin 21 hp	0,60	UR4	6630	-	-
Procut S Mot. B&S Comm. Turf Series 27 hp	0,70	BKR5ES	2460	07	4803
Procut S Mot. Kawasaki FS730V 24 hp	0,80	BPR4ES	7222	-	-

FICHTEL & SACHS - Débroussailleuses

Sachs	0,70	BMR6A	7421	01	5478
-------	------	-------	------	----	------

FICHTEL & SACHS - Tondeuses

Sachs	0,70	BR6HS	3922	-	-
SB 93	0,60	B-4H	4110	-	-
SB 102 / 126 / 151 / 151 A	0,60	B5HS	4210	-	-
ST 102 / 126 / 151	0,60	B7HS	5110	-	-
ST 203 / 204 / 251 / 282 Ø18 mm	0,60	AB-7	3010	-	-
ST 204 / 251 Ø14 mm	0,60	B7HS	5110	-	-
ST 76 / 96	0,60	B5HS	4210	-	-

FICHTEL-SACHS - Tronçonneuses

Sachs KS30 / KS31	0,60	BR7HS	4122	-	-
-------------------	------	-------	------	---	---

FLO-MOW - Tondeuses

Mot. B&S	0,70	BR2-LM	5798	06	4740
Mot. Tecumseh	0,70	BR4-LM	4133	05	4358

FLYMO - Débroussailleuses

BVL320 Blowervac	0,60	BPMR6A	6726	08	5063
HTL 170	0,60	BPM6A	7021	08	5063
Maxi Trim 380 / 430S / 460S	0,60	BPMR6A	6726	08	5063
Maxi Trim, Super Maxi Trim	0,60	BMR6A	7421	01	5478

FLYMO - Générateurs

BVL 320	0,50	BPMR7A	4626	02	5959
---------	------	--------	------	----	------

FLYMO - Outils Divers

BVL 320	0,50	BPMR7A	4626	02	5959
HTL 170	0,60	BPM6A	7021	08	5063
HTL 480	0,50	BPMR6A	6726	08	5063

FLYMO - Tondeuses

420 XL Vantage, 420XLPD / XLPDE	0,70	BR2-LM	5798	06	4740
508 Chief, F20	0,70	B2-LM	1147	06	4740
Chevron 420GL AutoDrive	0,60	BM6A	5921	01	5478
Chevron 420GL, Contractor GCL75	0,70	BMR6A	7421	01	5478
Contractor 21, 47, 52	0,70	BP5S	3011	-	-
Contractor 47T, MotorHacke 35	0,60	B4-LM	3410	05	4358
Contractor GT2-6	0,50	B6HS-5	6154	-	-
EC10 - Mot. Robin	0,60	BR6S	3522	09	6048
GT 2	0,50	B7HS	5110	-	-
GT2-7	0,50	BP4HS	3611	-	-
GT 4S, SP75B - Mot. B&S	0,60	B4-LM	3410	05	4358
L 38 Pilot, L 47 Pilot, L 50 Contractor	0,50	B4-LM	3410	05	4358
L 300	0,50	BPMR7A	4626	02	5959
L 400	0,70	BPMR6A	6726	08	5063
Lawnchief 508	0,70	B2-LM	1147	06	4740
LT 10/36, LT 12/36, LT 12/38, Maxi Trim/Super	0,80	BMR6A	7421	01	5478
Mot. Aspera	0,80	BR6S	3522	09	6048
Mot. B&S	0,70	BR2-LM	5798	06	4740
Mot. JLO	0,80	BP5HS	4111	-	-
Mot. Kirby KAV74	1,00	XR4	5858	-	-
Mot. Tecnamotor	0,60	BR4-LM	4133	05	4358
Mot. Tecumseh 3.5 hp	0,70	B4-LM	3410	05	4358
Professional, Super, Domestic	0,60	B4-LM	3410	05	4358
RL 400 / 500 / 550	0,60	B2-LM	1147	06	4740
RL 420 / PD / PDE	0,80	BMR6A	7421	01	5478
RL400 Mot. B&S	0,70	BR2-LM	5798	06	4740
RRL 420 / PD / PDE	0,70	B2-LM	1147	06	4740
SP75 Mot. Tecumseh	0,60	B6S	3510	09	6048

FOLUX - Tronçonneuses

F 2 / 3 / 3A / 4 / 4A / 5A / 6 / 7 / 7A / 8	0,70	BPMR6A	6726	08	5063
F 30 / 35 / 40 / 41 / 55A / 150 / 165 / 180A	0,70	BPMR6A	6726	08	5063

FORD - Manutention

Mot. 104 ci.	0,60	BPR6ES	7822	04	7678
Mot. 134 / 172 / 192 ci.	0,60	B-6L	3212	-	-
Mot. 158 / 175 ci.	0,60	B5ES	6410	-	-
Mot. 200 ci.	0,60	AR6FS	3323	-	-
Mot. 201 / 219 ci.	0,60	B5ES	6410	-	-

FORD - Manutention					
Mot. 250 ci. Ø14mm	0,60	B5ES	6410	-	-
Mot. 250 ci. Ø18mm	0,60	AR6FS	3323	-	-
Mot. 256 / 280 ci.	0,60	B5ES	6410	-	-
Mot. 300 / 330 ci.	0,60	AR6FS	3323	-	-
Mot. 351 ci. C	0,80	UR5	2771	-	-
Mot. 351 ci. W, Mot. 360 / 390 ci.	0,80	WR5	2438	-	-
Mot. 361 / 391 ci.	0,60	AR6FS	3323	-	-
Mot. 400 ci.	0,60	B5ES	6410	-	-
Mot. 460 ci.	0,70	UR4	6630	-	-
Mot. 477 / 534 ci.	0,60	AR6FS	3323	-	-

FORD - Tondeuses					
Mot. B&S	0,70	BR2-LM	5798	06	4740
Mot. Kohler K241 10 hp / K301 12 hp / K321 14 hp	0,60	B-6L	3212	-	-
Mot. Kohler K341 16 hp / K532 20 hp	0,60	B-6L	3212	-	-
Mot. Kohler OHV 12.5 & 14 hp / Twin 16 & 18 hp	1,10	BKR5ES-11	2382	-	-
Mot. Kohler V-Twin 18 / 20 hp	0,60	UR4	6630	-	-

FORD - Tronçonneuses					
960.1 / 960.2	0,80	BM6A	5921	01	5478
Hawk / Eagle I / Eagle II	0,60	BMR6A	7421	01	5478

FORESTER - Tronçonneuses					
CS-100 / CS-350 / CS-580	0,80	BM4A	5628	-	-

FOX - Tondeuses					
Tous modèles	0,70	BR2-LM	5798	06	4740

FRIGIDAIRE HOME PROD. - Tondeuses					
Riding Tractor - Mot. Kawasaki FD590V 18 hp	0,80	BMR6A	7421	01	5478

FRONTER-TML (Quadra) - Tronçonneuses					
Einhell / Fercad / Rocky / Greens B	0,70	BM7A	6521	10	6793
F35 / FB35 / F35VIP / FB35VIP	0,70	BM7A	6521	10	6793
Pionner / Ranch / Mark I / VIP / Star diffusion	0,70	BM7A	6521	10	6793

FUJI-ROBIN - Débroussailleuses					
BE 26 Mot. EC02F 27.2cc	0,70	BM7A	6521	10	6793
BE 221 Mot. 21.7cc	0,60	BM6A	5921	01	5478
BE 221 Mot. EC022GR 21.7cc, BE 251	0,70	BM7A	6521	10	6793
BH 2500 AU Mot. 24.5cc 4 tps	0,60	BM6A	5921	01	5478
BH 2500 Mot. 24.5cc 4 tps	0,60	CMR6A	1223	-	-
BH 3500 AU Mot. 33.5cc 4 tps	0,60	BM6A	5921	01	5478
BH 3600 AU Mot. 33.3cc 4 tps	0,60	BM6A	5921	01	5478
HT 01 Mot. EC01E 15.4cc / 15.5cc	0,70	BM7A	6521	10	6793
HT 02 / 02 T Mot. EC02R 22.5cc	0,70	BM7A	6521	10	6793
HT 171 Mot. EC01E 16cc	0,70	BM7A	6521	10	6793
HT 200 Mot. EC02ER 20.3cc	0,70	BM7A	6521	10	6793
HT 221 / 750 Mot. EC022GR 21.7cc	0,70	BM7A	6521	10	6793
HT 231 T Mot. EC02H 22.5cc	0,70	BM7A	6521	10	6793
NB 02 / 02 A / 02 T Mot. EC02R 22.5cc	0,60	BM7A	6521	10	6793
NB 02-2A / 02-2B	0,60	BM7A	6521	10	6793
NB 03, NB 024	0,60	B7HS	5110	-	-
NB 03 A Mot. EC02R 22.5cc	0,60	BM7A	6521	10	6793
NB 03-2D / 04	0,60	B7HS	5110	-	-
NB 04 Mot. 40cc	0,60	BM7A	6521	10	6793
NB 04-2D	0,60	B7HS	5110	-	-
NB 04-2D Mot. EC04-3R 40cc	0,60	BM7A	6521	10	6793
NB 04-2E / 04-2F	0,60	BR7HS	4122	-	-
NB 16, NB 16 F Mot. EC01E 15.4cc	0,60	BM7A	6521	10	6793
NB 16 S / 16 T Mot. EC01E 15.4cc	0,70	BM7A	6521	10	6793
NB 16 Z	0,60	BM7A	6521	10	6793
NB 24	0,60	BR7HS	4122	-	-
NB 26 / 27	0,60	BM7A	6521	10	6793
NB 26 / 27 Mot. EC02F 27.2cc	0,60	BM6A	5921	01	5478
NB 31	0,60	BM7A	6521	10	6793
NB 31 Mot. EC03 30.5cc	0,60	BM6A	5921	01	5478
NB 34	0,60	BR7HS	4122	-	-
NB 40	0,60	B7HS	5110	-	-
NB 50	0,60	BM7A	6521	10	6793

NB 50 L / 500 Mot. EC05M 51.7cc	0,60	BM6A	5921	01	5478
NB 171, NB 2001 Mot. EC020G 20cc	0,70	BM7A	6521	10	6793
NB 211 / 211 A / 211 AV / 211 AW / 212	0,60	BM7A	6521	10	6793
NB 211 / 211 C / 211 T Mot. EC02E 20.3cc	0,60	BM7A	6521	10	6793
NB 221	0,70	BM7A	6521	10	6793
NB 223, NB 223 Mot. EC022G 21.7cc	0,60	BM7A	6521	10	6793
NB 23 F / 23 S / 23 T Mot. EC02R 22.5cc	0,70	BM7A	6521	10	6793
NB 231 / 231 C Mot. EC02H 22.5cc	0,60	BM7A	6521	10	6793
NB 251 / 252 / 253 / 253 A Mot. EC025R 24.5cc	0,60	BM7A	6521	10	6793
NB 262 / 263	0,60	BPM7A	7321	02	5959
NB 281 / 281 AU Mot. EC02FH 27.2cc	0,70	BMR7A	4226	10	6793
NB 320 / 321	0,60	BM7A	6521	10	6793
NB 321 Mot. EC03F 30.5cc	0,70	BMR7A	4226	10	6793
NB 351	0,60	BPM7A	7321	02	5959
NB 351 Mot. EC03E 34.4cc	0,60	BM7A	6521	10	6793
NB 411	0,60	BPM7A	7321	02	5959
NB 411 Mot. EC04E 40.2cc	0,70	BMR7A	4226	10	6793
NBE 251, NBF 171 / 231 / 232 / 251 / 252	0,60	BM7A	6521	10	6793
NBF 171 Mot. EC01E 16cc	0,60	BM7A	6521	10	6793
NBF 211 / 2001 Mot. EC020G 20cc	0,60	BM7A	6521	10	6793
NBF 251 / 252 Mot. EC025R 24.5cc	0,60	BM7A	6521	10	6793
NBH 263	0,60	BPM7A	7321	02	5959
NBK 231 / 232	0,60	BM7A	6521	10	6793
NBK 262	0,70	BPM7A	7321	02	5959
NBK 263 / 351	0,60	BPM7A	7321	02	5959
NBK 351 Mot. 36cc	0,60	BM6A	5921	01	5478
NBK 411	0,60	BPM7A	7321	02	5959
NBK 411 Mot. 40cc	0,60	BM6A	5921	01	5478
NBKA 262, NBT 415	0,60	BPM7A	7321	02	5959
PT Mot. 16cc	0,60	BM6A	5921	01	5478

FUJI-ROBIN - Générateurs					
BH 2500	0,50	CM-6	5812	-	-
CB 04	0,60	B7HS	5110	-	-
CB 06	0,70	B6HS	4510	-	-
CB 411, CB 412	0,60	BPM7A	7321	02	5959
EC 004-3	0,70	B7HS	5110	-	-
EC 01A, EC 01E, EC 01ER, EC 01R	0,60	BM7A	6521	10	6793
EC 02, EC 02A/E/EH/EHR/ER/R	0,60	BM7A	6521	10	6793
EC 03, EC 03-2	0,60	B7HS	5110	-	-
EC 03E, EC 04E	0,70	BPM7A	7321	02	5959
EC 04, EC 04-3, EC 04-3E	0,60	B7HS	5110	-	-
EC 04EF, EC 04ER, EC 05EF	0,70	BPM7A	7321	02	5959
EC 04ERV	0,70	BPM4A	5928	-	-
EC 05, 05-2B/D, 06AB/AD/B/D, EC 07, 07-2B/D	0,60	B6HS	4510	-	-
EC 08B, EC 08D	0,60	B7HS	5110	-	-
EC 025E, EC 03EF, EC 03ER	0,70	BPM7A	7321	02	5959
EC 025GR	0,70	BM7A	6521	10	6793
EC 10 D / B	0,70	B-4	3210	-	-
EC 10, EC 10DD, EC 10HH, EC 10W, EC 10VY	0,60	B-4H	4110	-	-
EC 12 D / B	0,70	BM6A	5921	01	5478
EC 12, EC 13	0,60	BM6A	5921	01	5478
EC 13V	0,60	BMR6A	7421	01	5478
EC 17, EC 21	0,60	B-4H	4110	-	-
EC 25	0,60	B6HS	4510	-	-
EC 252DD(CDI), EC 252DS	0,60	BR6HS	3922	-	-
ECO 8B, ECO 8D	0,60	B7HS	5110	-	-
ECP 5, ECP 6AB/AD	0,60	B6HS	4510	-	-
EH 025, EH 035 / 035V	0,70	CMR6A	1223	-	-
EH 09	0,60	BMR6A	7421	01	5478
EH 12 D / B	0,70	B6HS	4510	-	-
EH 12, EH 12-2	0,60	B7ES	1111	-	-
EH 12-2 B / 12-2 D	0,60	BR6ES	4922	-	-
EH 17 B	0,70	B6HS	4510	-	-
EH 17 D / 25 D	0,70	BR6HS	3922	-	-
EH 17-2 B / 17-2 D / 25-2 B / 25-2 D	0,60	BR6HS	3922	-	-
EH 25 B	0,70	B6HS	4510	-	-
EH 30 D / B	0,80	BP6ES	7811	04	7678
EH 30, EH 34	0,70	B6ES	7310	-	-
EH 34 B	0,80	BP6ES	7811	04	7678
EH 36B / 36D / 41B / 41D	0,70	BP6ES	7811	04	7678
EH 72	0,70	BPR6ES	7822	04	7678
EX 13 / 13D / 17 / 17D / 21 / 21D / 27 / 27D	0,70	BR6HS	3922	-	-
EX 30D / 35 / 35D / 40 / 40D	0,70	BR6HS	3922	-	-
EY 08 D / B	0,70	BM4A	5628	-	-
EY 10 / 15 / 18 / 18-3 / 20 / 25 / 27	0,60	BR6HS	3922	-	-

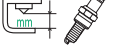
Modèle		N°			
		STOCK	BLISTER	STOCK	
		BOÎTE	BLISTER	BLISTER	
EY 15 D / B, EY 20 D / B	0,70	B6HS	4510	-	-
EY 20 V	0,60	BM4A	5628	-	-
EY 21	0,60	BMR6A	7421	01	5478
EY 23 D / B	0,70	BP4HS	3611	-	-
EY 28	0,60	BP6HS	4511	-	-
EY 28 D / B	0,70	BP6HS	4511	-	-
EY 35 D / B	0,70	B6HS	4510	-	-
EY 35K / 40K / 44	0,60	B-4H	4110	-	-
EY 40 D / B	0,70	B6HS	4510	-	-
F 12P	0,60	B7HS	5110	-	-
FA 51	0,60	B6S	3510	09	6048
FB 04	0,60	B7HS	5110	-	-
FG 14 III	0,60	B6HS	4510	-	-
FH 03 / 03-3A / 04 / 04-2A	0,60	B7HS	5110	-	-
FL 40	0,70	B7HS	5110	-	-
FL 4D	0,60	B7HS	5110	-	-
KC 252A	0,60	B6HS	4510	-	-
KE 51, KH 51	0,60	B6S	3510	09	6048
KM 51, KM 61	0,60	B7S	3710	-	-
NB 26 / 31 / 221 / 251	0,60	BM7A	6521	10	6793
NB 40	0,60	B7HS	5110	-	-
NB 211 / 223 / 253 / 321 / 411 / 2001	0,70	BPM7A	7321	02	5959
NBF 171 / 252, NBT 415	0,70	BPM7A	7321	02	5959
NF 03 / 03-2AD / 04 / 04-SA/SB	0,60	B7HS	5110	-	-
NF 302 / 351 / 352 / 400 / 411 / 412	0,70	BPM7A	7321	02	5959
NF 500 / 511 / 512 / 600	0,70	BPM7A	7321	02	5959
PR 06	0,70	B6HS	4510	-	-
PR 08	0,70	B7HS	5110	-	-
Pro 6	0,60	BP6HS	4511	-	-
Pro 8	0,70	B7HS	5110	-	-
Pro 250, Pro 270	0,80	BP5ES	6511	03	6854
Pro 400 / 400S E/G N°-> 1002006	0,60	B6HS	4510	-	-
Pro 400 / 400S E/G N°1002007->	0,70	B6ES	7310	-	-
Pro 500S	0,70	B6HS	4510	-	-
PS 04	0,60	B7HS	5110	-	-
R 12P	0,60	B7HS	5110	-	-
R 1100 / 1700i - Mot. EH09D	0,70	BMR4A	5728	-	-
R 1300 - Mot. EY15 3.5 hp	0,70	B6HS	4510	-	-
RC 04 / 04-2A / 04A / 04C, RC 07 / 07A	0,60	B7HS	5110	-	-
RCL 411	0,70	BPM4A	5928	-	-
RCO 600	0,80	BPR5EY	2828	-	-
RG 10 C / DC, 15 / C, 17 / D, 25 / D	0,70	B6HS	4510	-	-
RG 33 / D, 121 C / DC, 301D, 302, 401 / 401D	0,70	B6HS	4510	-	-
RG 3200i S - Mot. EX21D, RG 4300iS - Mot. EX27D	0,60	BR6HS	3922	-	-
RGK 161 / 301	0,60	BP4HS	3611	-	-
RGV 2800 - Mot. EH17-2 6 hp	0,70	B6HS	4510	-	-
RGV 4100 - Mot. EH25-2 8.5 hp	0,70	B6HS	4510	-	-
RGV 6100 - Mot. EH34 11 hp	0,70	B6HS	4510	-	-
RGV 7500 - Mot. EH41 13.5 hp	0,70	B6HS	4510	-	-
RGV 12100 - Mot. EH65 22 hp	0,70	B6HS	4510	-	-
RGV 13000T - Mot. EH63 18 hp	0,70	B6HS	4510	-	-
RGX 2900 - Mot. EX17 D	0,70	BR6HS	3922	-	-
RGX 3600 - Mot. EX21D	0,60	BR6HS	3922	-	-
RGX 4800 / E - Mot. EX27D	0,60	BR6HS	3922	-	-
RGX 6500 / 6500 E Mot. EX35 D	0,70	BR6HS	3922	-	-
RGX 7500 7500 E Mot. EX40 D	0,70	BR6HS	3922	-	-
RS 02 / 02B, RS 232 / 233, RSP 232, RSX	0,60	BM7A	6521	10	6793
RS 03 / 03-3A / 03-4	0,60	B7HS	5110	-	-
RS 301 / 331 / 350 / 401 / 412 / 450	0,60	B7HS	5110	-	-
RT 40 / 50 / 60	0,60	B6HS	4510	-	-
SD 04 / 04-2B	0,60	B7HS	5110	-	-
SD 06 / 06-B	0,60	B6HS	4510	-	-
SG 550 - Mot. EY08D	0,70	BMR4A	5728	-	-
SG 1000-II / SGL 1500-II - Mot. EY15D	0,60	BR6HS	3922	-	-
SG 2000-II & SGL 2000-II - Mot. EY20D	0,60	BR6HS	3922	-	-
SGL 2200-II, SGV 2200 / 2600 - Mot. EY17D	0,60	BR6HS	3922	-	-
SGL 3000-II - Mot. EY28D	0,80	BPR6HS	7022	-	-
SGV 4000 - Mot. EH25D	0,60	BR6HS	3922	-	-
SGX 3500 Mot. EX21 7 hp	0,70	BR6HS	3922	-	-
SGX 5000 Mot. EX30 9.5 hp	0,70	BR6HS	3922	-	-
SGX 7000E Mot. EX40 14 hp	0,70	BR6HS	3922	-	-
SP 06B	0,70	B6HS	4510	-	-
SP 170(5.7 HP)	0,60	BR6HS	3922	-	-
ST 041 / 052 / 41 / 50 / 51 / 52 / 60	0,60	BP4HS	3611	-	-
SX 17 / 21 / 30	0,60	BR4HS	3322	-	-

Modèle  N° STOCK N° BLISTER N° STOCK BOÎTE BLISTER

FUJI-ROBIN - Outils Divers

ST41 / 041 / 50 / 51 / 52 / 052 / 60	0,60	BP4HS	3611	-	-
--------------------------------------	------	-------	------	---	---

FULTON - Manutention

20	0,60	B-4L	3112	-	-
42	0,70	AB-6	2910	-	-
60	0,80	BP5ES	6511	03	6854
80	0,80	WR5	2438	-	-
27-40	0,70	AB-6	2910	-	-

GAMBLE ALDENS - Tondeuses

Tous modèles	0,70	BR2-LM	5798	06	4740
--------------	------	--------	------	----	------

GAR-BRO - Manutention

1000 / 1400	0,60	B6S	3510	09	6048
1200	0,60	B5ES	6410	-	-
Power Cart Mot. Gladden 75, Truck Mot. Willys	0,60	B6S	3510	09	6048
Truck Mot. Morris Minor	0,60	B5ES	6410	-	-

GARDEN KING - Tondeuses

Tous modèles	0,60	AB-6	2910	-	-
--------------	------	------	------	---	---

GARDEN PRIDE - Tondeuses

Tous modèles	0,60	B2-LM	1147	06	4740
--------------	------	-------	------	----	------

GARDEN - Tondeuses

Contractor 760 - Mot. B&S 12.5 hp	0,70	BR2-LM	5798	06	4740
Contractor 760 - Mot. Honda GXV 390	0,80	BPR5ES	7422	03	6854
Sprint 950 - Mot. Honda GXV 610 / 620	0,80	BPR5ES	7422	03	6854
Sprint 950 - Mot. Kohler Command 18 OHV	0,80	BPR5ES	7422	03	6854
Stingray - Mot. Honda GXV 620	0,80	BPR5ES	7422	03	6854
Stingray - Mot. Kohler Command 22 OHV	0,80	BPR5ES	7422	03	6854

GEHL - Manutention

GL2600	0,60	BR6ES	4922	-	-
GL4700	0,60	BP6ES	7811	04	7678
HL2500A, HL3000	0,60	B5ES	6410	-	-
HL4300	0,60	AB-6	2910	-	-
HL4500, HL4700 - GPL, SL3510, SL4510	0,70	BPR5ES	7422	03	6854
Mot. Ford 1.1L, 1.32L	0,90	TR5	2238	-	-

GENERAC - Générateurs

1470 Generac OHVI 14 hp	0,70	BKR5E	7938	07	4803
1645 Generac OHVI 7.8 hp	0,70	BKR5E	7938	07	4803
1646 B&S GenTek OHV 10 hp	0,70	BKR5E	7938	07	4803
B&S 1 Cyl.	0,60	B2-LM	1147	06	4740
B&S 16 hp	0,70	BKR5E	7938	07	4803
C 2400 / 4000 / 5000 / 5000E	0,70	B2-LM	1147	06	4740
C 8000 / 10000	0,70	BKR5E	7938	07	4803
Centurion 3250 3.25KW 1 Cyl.	0,70	BPR6ES	7822	04	7678
EPS 8 AC	0,70	BKR5E	7938	07	4803
EPS 12 / 20	0,90	BPR5ES	7422	03	6854
EPS 25	0,70	BPR6ES	7822	04	7678
Fiat 1.6L	0,70	BPR6ES	7822	04	7678
G 1000 / 1600	0,60	BPMR6A	6726	08	5063
G 1000M - Mot. Mitsubishi GM82 2.4 hp	0,60	BPR6HS	7022	-	-
G 2600	0,60	B6HS	4510	-	-
G 4000	0,60	BPR4HS	7823	-	-
Generac 1L / 1.2L	0,90	BPR6ES	7822	04	7678
Generac 1.3L	0,60	BP6ES	7811	04	7678
Generac 562 SXL	0,60	BPR5HS	6222	-	-
Generac II - 1.2L	0,90	BPR6ES	7822	04	7678
Generac II B&S 16 hp	0,70	BKR5E	7938	07	4803
Generac MC40	0,60	BPR5HS	6222	-	-
Generac TXP45	0,60	BR6S	3522	09	6048
GMC 2.5L 151ci.	0,60	BPR5ES	7422	03	6854
GMC 5.7L 350 ci., GMC 7.4L 454 ci.	0,90	UR4	6630	-	-
GP 15000E / 17500E	1,00	BKR5E	7938	07	4803
GP 1800 / 3250	0,70	BPR6ES	7822	04	7678
GP 5500, GP 6500/E, GP 7500E	0,70	BPR7ES	2023	-	-
Home & Away 1850	0,60	B2-LM	1147	06	4740
IM 60G	0,70	BR6S	3522	09	6048

Bougies d'allumage

Modèle

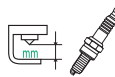
 N° STOCK BOÎTE
 N° BLISTER
 N° STOCK BLISTER

GENERAC - Générateurs					
IX 2000 Modèles 5793-0, 5793-1	0,70	CR5HSB	6535	-	-
IX 2000 Modèles 5793-2, 5793-3	0,70	BPR6ES	7822	04	7678
IX 800	0,70	CR7HSA	4549	-	-
IX1400, IX1600 5792-3	0,70	BPR7HS	6422	-	-
Kawasaki 1.6L, Kawasaki 3 hp	0,60	BPMR6A	6726	08	5063
Kawasaki 5 hp	0,60	B6HS	4510	-	-
L 4000 / 4000E / 5000 / 5000E	0,70	B2-LM	1147	06	4740
Lauson	0,70	B6S	3510	09	6048
LP 3250 / 5500	0,80	BPR7ES	2023	-	-
MC Series 1-Cyl. OHV, MC Series V-Twin	0,70	BKR5E	7938	07	4803
Mega 2500 / 2500T	0,60	B2-LM	1147	06	4740
MF 6500	0,70	BKR5E	7938	07	4803
Nissan 1.2L	0,90	BPR5ES	7422	03	6854
NP 45G / 55G / 65G	0,70	BKR5E	7938	07	4803
NP 80G / 100G	0,60	BPR6ES	7822	04	7678
Opel 1000cc	0,60	BP6HS	4511	-	-
Opel 1200cc	0,60	BPR6HS	7022	-	-
R 4000	0,60	B6HS	4510	-	-
R 3500XL / 6000 / 8000 / 8000E / 10000 / 10000E	0,70	BKR5E	7938	07	4803
Robin	0,60	B6HS	4510	-	-
S 1000	0,60	BM7A	6521	10	6793
S 1500 / 2400 / 4000 / 4000E / 5000	0,70	B2-LM	1147	06	4740
S 1600	0,60	B6HS	4510	-	-
S 2600	0,60	BPR4HS	7823	-	-
S 4000	0,70	BR6S	3522	09	6048
SG 012 / 016 / 020	0,90	BPR6ES	7822	04	7678
SG 015 / 020	0,90	TR5	2238	-	-
SV 1850	0,60	B2-LM	1147	06	4740
SV 2400 / 4200, SVP 5000	0,70	B2-LM	1147	06	4740
SVP 500T	0,70	BR6S	3522	09	6048
SVPE 5000, SVT 4200 / 5000	0,70	B2-LM	1147	06	4740
Tecumseh	0,70	BR4-LM	4133	05	4358
Wisconsin	0,70	WR5	2438	-	-
XE Series 1-Cyl. OHV	0,70	BKR5E	7938	07	4803
XG 10000E V-Twin	0,70	BPR6HS	7022	-	-
XG 4000 / 6500E / 7000E / 8000E	0,70	BKR5E	7938	07	4803
XL Series 1-Cyl. OHV, XL Series V-Twin	0,70	BKR5E	7938	07	4803
XP 10000E	0,70	BPR6HS	7022	-	-
XP 4000 / 6500E / 8000E	0,70	BKR5E	7938	07	4803

GENERAL - Manutention

Mot. Perkins G4-203	0,60	BP5ES	6511	03	6854
Continental	0,60	AB-6	2910	-	-
Hercules	0,60	B6S	3510	09	6048
Mot. Ford	0,80	WR5	2438	-	-
Mot. Ford 8RNN	0,60	B-6L	3212	-	-
Mot. Perkins G4-203	0,60	BP5ES	6511	03	6854

GIANNI FERRARI - Tondeuses

Mot. B&S V-Twin Vanguard 16 / 18 / 20 hp	0,80	BCPR5ES	6130	07	4803
--	------	---------	------	----	------

GILSON - Tondeuses

Mot. B&S	0,70	BR2-LM	5798	06	4740
Mot. Tecumseh	0,70	BR4-LM	4133	05	4358

GOLDEN BOY - Débroussailleuses

Tous modèles	0,70	BMR6A	7421	01	5478
--------------	------	-------	------	----	------

GOLDEN BOY - Tondeuses

Tous modèles	0,70	BR2-LM	5798	06	4740
--------------	------	--------	------	----	------

GOLDEN STAR - Débroussailleuses

Tous modèles	0,60	BM6A	5921	01	5478
--------------	------	------	------	----	------

GOLDEN STAR - Tondeuses

Mot. Kawasaki 1.5 hp	0,80	BM7A	6521	10	6793
Mot. Kawasaki 3.6 hp	0,70	BPR4HS	7823	-	-
Mot. Kawasaki 5 hp	0,80	BPR5ES	7422	03	6854
Mot. Kawasaki 6 hp	0,80	BP5HS	4111	-	-
Mot. Robin 1.9 & 3.7 hp	0,70	BR6HS	3922	-	-

Modèle

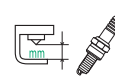
 N° STOCK BOÎTE
 N° BLISTER
 N° STOCK BLISTER

GOLF - Tondeuses					
Mot. Aspera	0,50	B4-LM	3410	05	4358
Mot. B&S	0,50	BR4-LM	4133	05	4358
Mot. B&S 3.5 hp	0,70	BR2-LM	5798	06	4740
Mot. Techna	0,50	B4-LM	3410	05	4358

GOODALL - Débroussailleuses

Tous modèles	0,70	BMR6A	7421	01	5478
--------------	------	-------	------	----	------

GRAINGER - Tronçonneuses

2Z573, 2Z760, 2Z970, 2Z971, 4Z022, 4Z023	0,60	BMR6A	7421	01	5478
--	------	-------	------	----	------

GRASS CUT - Tondeuses

Tous modèles	0,80	B-4H	4110	-	-
--------------	------	------	------	---	---

GRASS WAND - Tondeuses

Tous modèles	0,70	BR2-LM	5798	06	4740
--------------	------	--------	------	----	------

GRASSHOPPER - Tondeuses

614 2944471196A1 Mot. B&S 480cc	0,70	BKR5ES	2460	07	4803
616 3034471222A1 Mot. B&S 480cc	0,70	BKR5ES	2460	07	4803
718 3504471195A1 Mot. B&S 570cc	0,70	BKR5ES	2460	07	4803
720K PS64510 Mot. Kohler 22 hp	0,70	BKR5ES	2460	07	4803
721 WG750S-1 Mot. Kubota 750cc	1,10	BCPR4ES-11	2378	-	-
725 WG750B / WG750E Mot. Kubota 750cc	1,10	BCPR4ES-11	2378	-	-
725K PS68562 Mot. Kohler 725cc	0,70	BKR5ES	2460	07	4803
Mot. B&S Twin 16 / 18 hp	0,60	BR6S	3522	09	6048
Mot. B&S Vanguard OHV V-Twin 14 hp	0,70	BKR5ES	2460	07	4803
Mot. B&S V-Twin 20 hp	0,70	BKR5ES	2460	07	4803
Mot. Kawasaki OHV 27 hp	0,80	BPR5ES	7422	03	6854
Mot. Kohler 18 / 20 hp	0,70	BKR5ES	2460	07	4803
Mot. Kohler AEGIS 27 hp	0,60	BPR2ES	2264	-	-
Mot. Kohler Command Pro 23 / 27 hp	0,70	BKR5ES	2460	07	4803
Mot. Kohler K301S 12 hp	0,60	B-6L	3212	-	-
Mot. Kohler K341 16 hp	0,80	B-6L	3212	-	-
Mot. Kohler V-Twin 25 hp	0,70	BKR5ES	2460	07	4803

GRASSWAND - Débroussailleuses

Mot. Xenoah	0,70	BM7A	6521	10	6793
-------------	------	------	------	----	------

GRAVELY - Débroussailleuses

Pro-Trim -946153 Mot. Kohler XT-7.75 4.5 hp	0,80	BKR5ES	2460	07	4803
---	------	--------	------	----	------

GRAZER - Tondeuses

Mot. B&S Vangard V-Twin 18 / 20 hp	0,80	BKR5E	7938	07	4803
Mot. Kohler Twin 18 / 20 hp	0,80	BPR4FS	1127	-	-
Mot. Kohler V-Twin 22 hp, Mot. Kubota	0,80	BKR5E	7938	07	4803

GREAT DANE - Tondeuses

Brutus- GBKH2752S Mot. Kohler 27 hp	0,70	BKR5ES	2460	07	4803
Brutus- GBKH2761S Mot. Kohler 27 hp	0,70	BKR5ES	2460	07	4803
Brutus- GBKW2552S Mot. Kawa. 25 hp	0,80	BPR2ES	2264	-	-
Brutus- GBKW2561S Mot. Kawa. 25 hp	0,80	BPR2ES	2264	-	-
Chariot- GCBR2348S Mot. B&S Vang. 23 hp	0,70	BKR5ES	2460	07	4803
Chariot- GCBR2652S Mot. B&S 26 hp	0,70	BKR5ES	2460	07	4803
Chariot- GCKA1948S Mot. Kawa. KAI 19 hp	0,80	BPR4ES	7222	-	-
Chariot- GCKH2352S Mot. Kohler 23 hp	0,70	BKR5ES	2460	07	4803
Chariot- GCKW2352S Mot. Kawa. 23 hp	0,80	BPR4ES	7222	-	-
Chariot- GCKW2561S Mot. Kawa. 23 hp	0,80	BPR4ES	7222	-	-
Mot. B&S 10.5 hp	0,70	BR2-LM	5798	06	4740
Mot. B&S V-Twin Vang. 16 / 18 / 20 hp	0,90	BKR5E	7938	07	4803
Mot. Kawa. OHV 14 / 15 / 17 / 19 hp	0,80	BPR5ES	7422	03	6854
Mot. Kawasaki 14 hp	0,70	BPR5ES	7422	03	6854
Mot. Kawasaki 15 hp	0,60	BCPR6ES	2330	-	-
Mot. Kawasaki 19 / 23 / 25 hp	0,70	BPR4ES	7222	-	-
Mot. Kawasaki FB460V 12.5 hp	0,80	BMR6A	7421	01	5478
Mot. Kawasaki V-Twin 23 / 25 hp	0,80	BPR5ES	7422	03	6854
Mot. Kohler 22 / 23 / 25 / 27 hp / Command 18 hp	0,70	BKR5ES	2460	07	4803
Mot. Kohler Command OHV 15 hp	0,90	BKR5E	7938	07	4803
Mot. Kohler EFI 26 / 28 hp	0,70	BKR5ES	2460	07	4803

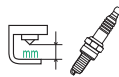

Mot. Kohler V-Twin 18 / 20 / 22 / 23 / 25 hp	0,90	BKR5E	7938	07	4803
Mot. Kohler V-Twin EFI 26 / 27 / 28 hp	0,90	BKR5E	7938	07	4803
Scamper-GLKA1536S Mot. Kawa. KAI 15 hp	0,80	BPR4ES	7222	-	-
Scamper-GLKA1948S Mot. Kawa. KAI 19 hp	0,80	BPR4ES	7222	-	-
Scamper-GLKA1952S Mot. Kawa. KAI 19 hp	0,80	BPR4ES	7222	-	-
Scamper-GLKW1536S Mot. Kawa. KAI 15 hp	0,80	BPR4ES	7222	-	-
Scamper-GLKW1748S Mot. Kawa. KAI 17 hp	0,80	BPR4ES	7222	-	-
Super Surfer GSKA1948S Kawa. KAI 19hp	0,80	BPR4ES	7222	-	-
Super Surfer GSKH2352S Mot. Kawa. 23 hp	0,80	BPR4ES	7222	-	-
Super Surfer GSKW2352S Mot. Kawa. 23 hp	0,80	BPR4ES	7222	-	-
Surfer-GSRKA1934S Mot. Kawa. KAI 19 hp	0,80	BPR4ES	7222	-	-
Surfer-GSRKA1948S Mot. Kawa. KAI 19 hp	0,80	BPR4ES	7222	-	-
Surfer-GSRKA1952S Mot. Kawa. KAI 19 hp	0,80	BPR4ES	7222	-	-
Surfer-GSRKW2352S Mot. Kawa. 23 hp	0,80	BPR4ES	7222	-	-

GREEN MACHINE - Débroussailleuses

1940	0,80	BPMR6F	1270	-	-
4500	0,80	B7S	3710	-	-
1600, 1930, 2230	0,70	BMR6F	2144	11	7683
1700, 1730, 1900/E, 1930M, 1940M	0,70	BMR6A	7421	01	5478
2000, 2100, 2200, 2300, 2400/M3, 2500	0,70	BMR6A	7421	01	5478
2500LP, 2540LP, 3000LP, 3800LP	0,70	BPMR7A	4626	02	5959
2600/H, 2800, 2840, 3000 /B/J/M/SS, 3040M	0,70	BMR6A	7421	01	5478
3510, 3540, 4000/B/J/M	0,70	BMR6A	7421	01	5478
4000LP, 4500LP	0,70	BPMR6A	6726	08	5063
Mot. B&S	0,70	BR2-LM	5798	06	4740

GREEN MACHINE - Tronçonneuses

20	0,80	BPMR6F	1270	-	-
30, 33, 38	0,80	BPMR7A	4626	02	5959
7100, 7200, 7400	0,70	BMR6A	7421	01	5478
7600, 7700	0,70	BPMR6A	6726	08	5063

GREEN TEAM - Tondeuses

Mot. B&S 5.5 / 8.5 / 10.5 hp	0,70	BR2-LM	5798	06	4740
Mot. Honda 9 / 13 hp	0,80	BPR5ES	7422	03	6854

GREENS - Tondeuses

Villiers	0,70	BR6HS	3922	-	-
Zephir - Mot. B&S	0,70	BR6S	3522	09	6048

GROOMER - Débroussailleuses

Tous modèles	0,80	BM4A	5628	-	-
--------------	------	------	------	---	---

GROW GEAR - Débroussailleuses

Mot. Tas	0,60	BM6A	5921	01	5478
----------	------	------	------	----	------

GÜDE - Tondeuses

Big Wheeler 508 A / 508 VARI-S	0,70	BPR6ES	7822	04	7678
Big Wheeler 560 Mega / 560 Super / 560 Trike	0,70	BPR6ES	7822	04	7678
Eco Wheeler 400 k	0,80	BPR5ES	7422	03	6854
PM 460 Deluxe 4 in 1 / 510 D / 560 D	0,70	BPR6ES	7822	04	7678

GULF - Tondeuses

Mot. B&S	0,70	BR2-LM	5798	06	4740
Mot. Tecumseh	0,70	BR6S	3522	09	6048

GUTBROD - Outils Divers

1100 H / 1200 H Mot. B&S	0,60	BCPR5ES	6130	07	4803
250 MS 4 Vantage 35T	0,50	BR2-LM	5798	06	4740
G 550 / 650 Mot. Kawasaki	0,60	B-4H	4110	-	-
G 750 Mot. Kawasaki	0,60	BPR5ES	7422	03	6854
GAB 35 Mot. B&S	0,50	BR4-LM	4133	05	4358
HAE B Mot. B&S	0,50	BR2-LM	5798	06	4740
MB 50-35 Mot. B&S	0,50	BR4-LM	4133	05	4358
MB 62 Mot. B&S	0,50	BR2-LM	5798	06	4740
MB 62-35 Mot. B&S, MB 62-52 Mot. B&S	0,50	BR4-LM	4133	05	4358
MB 65-30 Mot. Kawasaki	0,60	BM6A	5921	01	5478
MK 65-30 Mot. Kawasaki	0,60	BPR6ES	7822	04	7678
MK 90-50 Mot. Kawasaki	0,60	BM6A	5921	01	5478

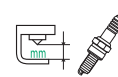

GUTBROD - Tondeuses					
170 SD 4 - Mot. Tecumseh	0,50	BR4-LM	4133	05	4358
370 BMR 4 Vantage 35T	0,50	BR2-LM	5798	06	4740
800 / 850	0,60	BR2-LM	5798	06	4740
1000 E / 1002 E - Mot. B&S	0,50	BR2-LM	5798	06	4740
1012 S - Mot. B&S	0,60	BR2-LM	5798	06	4740
1114 AWS - Mot. B&S	0,60	BCPR5ES	6130	07	4803
1400	0,60	BR2-LM	5798	06	4740
BM 100 2G 1431 / 1433	0,60	B6HS	4510	-	-
BM 107 - Mot. Kawasaki	0,60	BM6A	5921	01	5478
BM 700 92982 - Mot. B&S	0,50	BR4-LM	4133	05	4358
BM 700 Vantage - Mot. B&S, BM 710 Mot. B&S	0,50	BR4-LM	4133	05	4358
BM 91 FA130 - Mot. Kawasaki	0,60	BM6A	5921	01	5478
ECO B / BR - Mot. B&S	0,50	BR4-LM	4133	05	4358
Euro Class XM35 / 50 - Mot. B&S Quant.	0,50	BR2-LM	5798	06	4740
HB 255 REL / HB 46 R / H B55 R	0,80	BMR6A	7421	01	5478
HB 40 / L, HB 45 / E / LE	0,80	BMR6A	7421	01	5478
HB 42 L / LE / RL - Mot. B&S	0,50	BR4-LM	4133	05	4358
HB 45 REL / Prof 430 G/510 - Mot. B&S	0,80	BMR6A	7421	01	5478
HB 46-2T / HB 46-4T (Mot. Tecna)	0,80	BMR6A	7421	01	5478
HB 48 / L / REL / RL - Mot. B&S	0,50	BR4-LM	4133	05	4358
HB 53 RL / HBM 50	0,70	B2-LM	1147	06	4740
MH 404 - Mot. B&S	0,50	BR4-LM	4133	05	4358
MH 454 B / BE / RB / RBE - Mot. B&S	0,50	BR4-LM	4133	05	4358
MH 454 RSB / RSEB / SEB - Mot. B&S	0,50	BR4-LM	4133	05	4358
MH 454 RV - Mot. Kawasaki	0,60	BPR6ES	7822	04	7678
MH 464 B / RV6 / RVE 6	0,70	BR2-LM	5798	06	4740
MH 534 PR / RV / RVE - Mot. Kawasaki	0,60	BPR6ES	7822	04	7678
MH 544 R3 / RE - Mot. B&S	0,60	BR2-LM	5798	06	4740
Mot. Mag	0,50	B5HS	4210	-	-
MV 504 - Mot. B&S	0,50	B4-LM	3410	05	4358
Prof 510FSR (Sachs)	0,80	BMR6A	7421	01	5478
RSB 80-12 - Mot. B&S	0,50	BR2-LM	5798	06	4740
RSB 100-12 - Mot. B&S	0,60	BR2-LM	5798	06	4740
RSB 110-16H - Mot. B&S	0,60	BCPR5ES	6130	07	4803
SB 46	0,70	B2-LM	1147	06	4740
SB 48 - Mot. B&S	0,50	BR4-LM	4133	05	4358
Sprint 1002 E / 1012 S - Mot. B&S	0,60	BR2-LM	5798	06	4740
Sprint 2000	0,70	B2-LM	1147	06	4740
Sprint 3000 - Mot. B&S	0,60	BCPR5ES	6130	07	4803
Sprint 900	0,70	B2-LM	1147	06	4740
Super Class FC150V - Mot. Kawasaki	0,60	BPR6ES	7822	04	7678
Super Class XM35 / 50 - Mot. B&S Quant.	0,50	BR2-LM	5798	06	4740
VB 38	0,70	B2-LM	1147	06	4740

H.M.C. - Débroussailleuses

1600, 1930, 1940, 2230	0,70	BM6F	6221	11	7683
1700, 1730, 1900, 1900E, 1930M, 1940M	0,60	BM6A	5921	01	5478
2000, 2100, 2200, 2300 series, 2400, 2500	0,60	BM6A	5921	01	5478
2400M3, 260h	0,60	BM6A	5921	01	5478
2500LP, 2540LP, 3000LP, 3800LP	0,60	BPM7A	7321	02	5959
2600, 2800, 2840, 3000 / B / J	0,60	BM6A	5921	01	5478
3000M / SS, 3040M, 3510, 3540, 4000 / B / J / M	0,60	BM6A	5921	01	5478
4000LP, 4500LP	0,60	BPM7A	7321	02	5959
4500	0,80	B7S	3710	-	-
Mot. B&S	0,60	B2-LM	1147	06	4740

HAHN - Tondeuses

120	0,60	B4-LM	3410	05	4358
Boy 8610	0,50	AB-6	2910	-	-
Boy JIO engine	0,50	B5HS	4210	-	-
Combinette 100	0,60	B4-LM	3410	05	4358
Combinette 3604	0,50	B5HS	4210	-	-
Gartentrac 1100E / 1600E	0,60	B4-LM	3410	05	4358
Hakaboy 8611	0,60	AB-6	2910	-	-
Hako Combinette, Hako Variette F&S	0,70	BR6HS	3922	-	-
Hakomobil 4000	0,60	BP6HS	4511	-	-
Hakorette 150	0,50	B5HS	4210	-	-
Hakorette 200	0,50	BM6A	5921	01	5478
Hakorette 5003/5004/5007/5008/5035	0,50	AB-6	2910	-	-
Hakotrac 700,1000	0,70	BR6S	3522	09	6048
Hakotrac 1200,1400	0,70	BR6HS	3922	-	-
Hakotrac 2000	0,70	B-6L	3212	-	-
Hamster 6206	0,70	B6S	3510	09	6048

Modèle

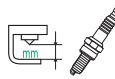
 N° STOCK BLISTER
 N° BOÎTE
 N° STOCK BLISTER
 N° BLISTER

HAHN - Tondeuses					
Hamster S	0,70	B-4H	4110	-	-
Jardinette 3605	0,70	B6S	3510	09	6048
JLO - Ø14 mm	0,70	BR6HS	3922	-	-
JLO - Ø18 mm	0,60	AB-6	2910	-	-
Jonas 1600	0,60	B5HS	4210	-	-
Minette	0,60	B4-LM	3410	05	4358
Mot. ILO Ø14 mm	0,50	B5HS	4210	-	-
Mot. ILO Ø18 mm	0,50	AB-6	2910	-	-
Profi 92 Jlo Engine	0,60	B5HS	4210	-	-
Rasentrac 600	0,70	B6S	3510	09	6048
Rasentrac 708 / 708E / 800 / 1000E	0,60	B4-LM	3410	05	4358
Rasentrac 800E	0,70	BR6S	3522	09	6048
Rasetta 18L, 20H/L/N/S, Rasetta 22 R / S	0,60	B4-LM	3410	05	4358
Tous modèles	0,70	BR2-LM	5798	06	4740
Trac 1200,1400	0,70	B-4H	4110	-	-
Trac 8014	0,60	B6HS	4510	-	-
Variette	0,50	B5HS	4210	-	-
Variette 3615	0,50	B6HS-5	6154	-	-

HANDY-VAN - Manutention

Tous modèles	0,60	AB-6	2910	-	-
--------------	------	------	------	---	---

HANNIBAL - Tondeuses

Tous modèles	0,70	BR2-LM	5798	06	4740
--------------	------	--------	------	----	------

HARLEY-DAVIDSON - Manutention

Utilicar DC	0,90	BPR4ES	7222	-	-
Utilicar GE	0,70	B-6L	3212	-	-

HARLO - Manutention

Handler - Mot. Kohler	0,60	B-6L	3212	-	-
-----------------------	------	------	------	---	---

HARRY - Tondeuses

302 DFB	0,60	B6HS	4510	-	-
302 EFA / QFA	0,60	B4-LM	3410	05	4358
302 QFB - Mot. B&S Quant.	0,60	BM6A	5921	01	5478
302 QZB / 313 MZB - Mot. B&S	0,70	BR2-LM	5798	06	4740
313 QFA / 314 EFA	0,60	B4-LM	3410	05	4358
313 QFB / 314 QFB / 322 LFB - Mot. B&S Quant.	0,60	BM6A	5921	01	5478
401 / 424 / 471 LFB - Mot. B&S Quant.	0,60	BM6A	5921	01	5478
401 LZB / MZB - Mot. B&S	0,70	BR2-LM	5798	06	4740
401 QFA, 411 QFA / EFA	0,60	B4-LM	3410	05	4358
411 QFB / 451 AFB - Mot. B&S Quant.	0,60	BM6A	5921	01	5478
451 AZB / LZB - Mot. B&S	0,70	BR2-LM	5798	06	4740
451 DFB	0,60	B6HS	4510	-	-
451 QFA	0,60	B4-LM	3410	05	4358
451 QFB / LFB, 471 AFB - Mot. B&S Quant.	0,60	BM6A	5921	01	5478
471 AZB - Mot. B&S	0,70	BR2-LM	5798	06	4740
471 DFB	0,60	B6HS	4510	-	-
471 DFF	0,60	B5HS	4210	-	-
471 PZB - Mot. B&S	0,70	BR2-LM	5798	06	4740
471 VFB - Mot. B&S OHV	0,80	BCPR5ES	6130	07	4803
772 VZB - Mot. B&S	0,70	BR2-LM	5798	06	4740
Mot. B&S 3.5 / 3.75 / 4 / 4.5 / 5 / 5.5 / 6 / 6.5 hp	0,70	BR2-LM	5798	06	4740
Mot. B&S Intek OHV	0,70	BKR5ES	2460	07	4803
Mot. B&S Intek OHV 6 hp	0,80	BKR5E	7938	07	4803
Mot. Honda OHV 5.5 hp, Mot. Kawasaki 6 hp	0,80	BPR5ES	7422	03	6854
Mot. Tecumseh 3.5 / 5 hp	0,70	BR6S	3522	09	6048

HAYTER - Tondeuses

Mot. B&S	0,80	BMR6A	7421	01	5478
Mot. Kohler, Mot. Tecumseh	0,70	BR4-LM	4133	05	4358

HEALD - Tondeuses

Mot. B&S	0,80	B2-LM	1147	06	4740
Mot. Tecumseh	0,60	B6S	3510	09	6048

HECKENDORN - Tondeuses

Mot. B&S 10 / 16 hp	0,70	BR2-LM	5798	06	4740
Mot. B&S Vanguard V-Twin 16 hp	0,80	BKR5E	7938	07	4803

Modèle

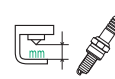
 N° STOCK BLISTER
 N° BOÎTE
 N° STOCK BLISTER
 N° BLISTER

Mot. Ford 67 cid	0,90	BPR6ES	7822	04	7678
Mot. Honda OHV 11 / 13 hp	0,90	BPR5ES-11	4424	-	-
Mot. Kohler	0,70	B-6L	3212	-	-
Mot. Kubota	0,80	BKR5E	7938	07	4803
Mot. Wisconsin	0,90	AB-6	2910	-	-
Mot. Wisconsin Twin 30 hp	0,90	BR6ES	4922	-	-

HEFTY - Manutention

A-616 - Mot. B&S	0,60	BM6A	5921	01	5478
------------------	------	------	------	----	------

HERKULES - Débroussailleuses

AST 250 / TBC 600 SDH	0,50	BPM6A	7021	08	5063
TBC 2211 SDH / N, 2251	0,50	BPMR6A	6726	08	5063
TBC 270 PF / PFD	0,50	BMR7A	4226	10	6793
TBC 340 SDH	0,70	BM7A	6521	10	6793
TBC 430 PFD	0,70	BPMR7A	4626	02	5959

HERKULES - Outils Divers

3500 Compact, 4000 Profi	0,70	BPR6ES	7822	04	7678
KM 450 T	0,60	BPMR6A	6726	08	5063
KM 600 H	0,70	BPR6ES	7822	04	7678
KM 600 T	0,70	BR2-LM	5798	06	4740
KM 702 Mot. Honda GCV135	0,70	BPR6ES	7822	04	7678
KM 750	0,70	BR2-LM	5798	06	4740
LS 360 Mot. Honda GX120	0,70	BPR6ES	7822	04	7678
LS 460 Mot. Honda GX160	0,70	BPR6ES	7822	04	7678
MH 202 T	0,60	BPMR6A	6726	08	5063
MH 300	0,50	B4-LM	3410	05	4358
MH 325 T	0,70	BR2-LM	5798	06	4740
MH 50 / 50 R	0,50	B4-LM	3410	05	4358
MH 522 BR	0,70	BR2-LM	5798	06	4740
MH 562 HR, MH 580	0,70	BPR6ES	7822	04	7678
SF 50	0,60	BPR5ES	7422	03	6854
TBL 4600	0,60	BPM6A	7021	08	5063
TCS 3401, THB 2510 / 2510 V	0,60	BPMR6A	6726	08	5063
TPH 2510, TPS 2510	0,60	BPMR6A	6726	08	5063
UE 500 Super H	0,70	BPR6ES	7822	04	7678
UE 500 Super T	0,50	BR4-LM	4133	05	4358
UE 510 H	0,70	BPR6ES	7822	04	7678
UE 510 Super I, UE 600	0,60	BR4HS	3322	-	-
UE 600 A	0,60	B-4H	4110	-	-
UE 600 H	0,70	BPR6ES	7822	04	7678
UE 600 i	0,60	B-4H	4110	-	-

HERKULES - Tondeuses

11/30 - 12/40	0,50	BR2-LM	5798	06	4740
14/40	0,70	BR6S	3522	09	6048
16/43-4WS	0,50	BR2-LM	5798	06	4740
155 6-Speed	0,70	BKR5ES	2460	07	4803
180 Automatic, 200 HXL Automatic	0,70	BKR5ES	2460	07	4803
400B - Mot. B&S	0,70	BR2-LM	5798	06	4740
AR 45 - Mot. B&S	0,60	BM6A	5921	01	5478
B400	0,70	BR2-LM	5798	06	4740
BM 200 / 200T	0,50	BR4-LM	4133	05	4358
D 3 / D 6 - Mot. B&S	0,60	BM6A	5921	01	5478
E51B - Mot. B&S	0,70	BR2-LM	5798	06	4740
E51H - Mot. Honda	0,70	BPR6ES	7822	04	7678
FM 300 H	0,60	BPR6ES	7822	04	7678
FM 300 T	0,50	BR4-LM	4133	05	4358
GT 47SB / 47SBM / 47BM - Mot. B&S	0,70	BR2-LM	5798	06	4740
GT 48B / 48SB / 53SB / 56SBV - Mot. B&S	0,70	BR2-LM	5798	06	4740
Harry 302 MZB	0,50	BR4-LM	4133	05	4358
Harry 302 QZA / QZB, Harry 313 MZB	0,50	BR2-LM	5798	06	4740
Harry 313 QZA, Harry 401 LZA / LZB / MZB	0,50	BR4-LM	4133	05	4358
Harry 411 QZA	0,50	BR2-LM	5798	06	4740
Harry 451 AZB	0,50	BR4-LM	4133	05	4358
Harry 451 LZB, Harry 471 AZB / PZB / VZA	0,50	BR2-LM	5798	06	4740
Harry 772 VZB	0,50	BR2-LM	5798	06	4740
HTC 13 / 13,5 Plus	0,70	BR2-LM	5798	06	4740
HTC 15,5 Plus, 16 / 16H Plus, 18H / 20H Plus	0,70	BKR5ES	2460	07	4803
HTC Junior 130	0,70	BR2-LM	5798	06	4740
MB 40ST / 40T / 48T / 48ST	0,50	BR4-LM	4133	05	4358
MB 48SB / 48SBV / 55SBV	0,50	BR2-LM	5798	06	4740
MB 53SHV / 55SHV	0,70	BPR5ES	7422	03	6854
MB 410 / 460 / 460 S / 460 ES - Mot. B&S	0,60	BM6A	5921	01	5478

Modèle

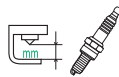

N° STOCK N° BLISTER N° STOCK
BOÎTE BLISTER

MB 462 - Mot. B&S 2.9kW	0,50	B4-LM	3410	05	4358
MB 462 S - Mot. B&S 3.3kW	0,50	B4-LM	3410	05	4358
MB 482SH / 532SH	0,70	BPR6ES	7822	04	7678
MCB 46 / 46S, MR 432	0,70	BR2-LM	5798	06	4740
Orec FL 500 Mot. Honda GXV160	0,60	BPR5ES	7422	03	6854
Orec HR 660 B Mot. Robin 5.5kW	0,60	BP6HS	4511	-	-
Orec SH 60 Mot. Kawasaki 4.5kW	0,60	BPR5ES	7422	03	6854
Orec SH 70 Mot. Honda GXV270	0,70	BPR5ES	7422	03	6854
R 434 / R 484TR - Mot. B&S	0,60	BM6A	5921	01	5478
TN 195 SEK / SXK, TN 215 SEK / SXKE	0,80	BP6ES	7811	04	7678
Turbo Cut HTC 120	0,50	BR2-LM	5798	06	4740
Turbo Cut HTC 150 / 180 H	0,70	BCPR5ES	6130	07	4803
Twin-Cut 12,5 Plus	0,50	BR2-LM	5798	06	4740
Twin-Cut 15 / 15.5 H / 16 / 16H / 18 Plus	0,70	BCPR5ES	6130	07	4803
WM60B	0,70	BKR5ES	2460	07	4803
WM60BR	0,70	BR2-LM	5798	06	4740

HESSTON - Tondeuses

Mot. B&S	0,80	B2-LM	1147	06	4740
Mot. Kohler	0,80	B-6L	3212	-	-

HIGH WHEEL CHAMP - Tondeuses

Mot. B&S	0,70	BR2-LM	5798	06	4740
----------	------	--------	------	----	------

HIRTH - Générateurs

04	0,60	BPMR6A	6726	08	5063
08	0,60	B7HS	5110	-	-
84 / 85 / 112 / 150 / 151	0,60	AB-6	2910	-	-
102	0,80	B5HS	4210	-	-
152	0,60	B6HS-5	6154	-	-
241	0,80	B5HS	4210	-	-
263	0,90	B7ES	1111	-	-
1440 / 1444	0,60	B6HS-5	6154	-	-
2702	0,60	B8HS	5510	-	-

HIRTH - Tondeuses

240 / 241	0,70	BR6HS	3922	-	-
-----------	------	-------	------	---	---

HMC - Tronçonneuses

Green Machine Mot. Xenoah	0,70	BM7A	6521	10	6793
---------------------------	------	------	------	----	------

HOBART - Manutention

I.H.C. Mot. UV549	0,80	B6S	3510	09	6048
-------------------	------	-----	------	----	------

HOFFCO - Débroussailleuses

1493, MP633	0,50	BMR6A	7421	01	5478
6830-16	0,70	BR6S	3522	09	6048
Aladdin - Mot. Robin / Fuji	0,70	BM7A	6521	10	6793
B16	0,70	BPMR6A	6726	08	5063
BP550	0,70	BR6S	3522	09	6048
Critter, GT210 / 211	0,70	BMR6F	2144	11	7683
EH025 - Mot. Robin Subaru	0,60	CMR6A	1223	-	-
GT21 / 211A - McCulloch 21.2cc 6 hp	0,70	BMR6F	2144	11	7683
GTX, GTX-R Genie	0,70	BM7A	6521	10	6793
HB250	0,70	BPMR6F	1270	-	-
HD	0,70	B-6L	3212	-	-
JP 220F - Mot. Fuji 21.7cc 1 hp	0,70	BM7A	6521	10	6793
JP 260	0,70	BMR6F	2144	11	7683
JP 300	0,50	BMR6A	7421	01	5478
JP 300F - Mot. Fuji 24.5cc 1.2hp	0,70	BM7A	6521	10	6793
JP 390	0,50	BMR6A	7421	01	5478
JP 390C ECO 3 - Mot. Fuji 30.5cc, JP 390F	0,70	BM7A	6521	10	6793
Kawasaki - EC 02R / 01R, H1AH, G1AH	0,50	BMR6A	7421	01	5478
Kawasaki - F2/2, HB220, WT250HT	0,50	BMR6A	7421	01	5478
Little hoe	0,70	BPM7A	7321	02	5959
Mot. B&S	0,70	BR2-LM	5798	06	4740
Mot. Power Products AV52	0,70	BR6S	3522	09	6048
Mot. Tecumseh	0,70	BR2-LM	5798	06	4740
Mot. Tecumseh 85cc 3 hp	0,80	BR4-LM	4133	05	4358
Whizz Witch - Mot. Tecumseh	0,60	BR4-LM	4133	05	4358
WT 250C / 250F, XL	0,70	BM6A	5921	01	5478
WW88 Mot. 3 hp 85cc Tecumseh	0,80	BR4-LM	4133	05	4358

Modèle

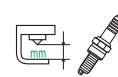

N° STOCK N° BLISTER N° STOCK
BOÎTE BLISTER

HOFFCO - Générateurs

GT 21 / 211A, JP 260A / 260C	0,80	BMR6F	2144	11	7683
JP 220F / 390F	0,80	BM7A	6521	10	6793
JP 300B / 300C / 300F / 390A / 390C	0,80	BMR6A	7421	01	5478
SE 301 / 301F, WT 250C / 250F	0,80	BMR6A	7421	01	5478
WW8	0,80	BR4-LM	4133	05	4358

HOFFCO - Tondeuses

Mot. B&S	0,70	BR2-LM	5798	06	4740
Mot. Fuji-Robin	0,80	BM7A	6521	10	6793
Mot. Power Product	0,70	BR6S	3522	09	6048

HOFFCO - Tronçonneuses

D4 / D58	0,60	BMR6A	7421	01	5478
Mot. West Bend	0,70	B-6L	3212	-	-
T4 / T58 / S480 / Super 510	0,60	BMR6A	7421	01	5478
Timberline T47 / T81 / TJM	0,80	BR6S	3522	09	6048

HOLDER - Tondeuses

Mot. B&S	0,50	B4-LM	3410	05	4358
Mot. F&S - Ø14 mm	0,50	B5HS	4210	-	-
Mot. F&S - Ø18 mm	0,50	AB-6	2910	-	-
Mot. ILO - Ø14 mm	0,50	B5HS	4210	-	-
Mot. ILO - Ø18 mm	0,50	AB-7	3010	-	-
Mot. Intermotor	0,50	B-4H	4110	-	-
Mot. Lombardini	0,70	B-4H	4110	-	-

HOMELITE - Débroussailleuses

BCH 20 / 24 / 32 C / 33 / 33B / 40 / 48	0,60	BM6A	5921	01	5478
F 2015 / 2035 / 3040 / 3045 / 3055	0,60	BPMR7A	4626	02	5959
HBC 18 / 28 / 38 / 40	0,70	BPMR6F	1270	-	-
HBC 26SB / 26SBS / 26SJ / 26SJS	0,60	BPMR7A	4626	02	5959
HBC 30 / 30B / 30SBS / 45SBS	0,60	BPMR7A	4626	02	5959
HK 18 / 24 / 28 / 33	0,60	BMR6A	7421	01	5478
HLT 15 / 16 / 18 / 28, HLT 17C	0,70	BPMR6F	1270	-	-
HLT 26 CD / CDSY / CDY	0,60	BPMR7A	4626	02	5959
I625 cd, I725 cc / ce / cea, I730ca / cc	0,60	BPMR7A	4626	02	5959
PBC 3600 / 3600B / 3800 / 4000	0,60	BPMR7A	4626	02	5959
PSE 3000	0,80	BPM6F	5950	-	-
Serie ZR : 625 / 725 / 825 / 830 / 885	0,60	BPMR6F	1270	-	-
ST 80 / 90 / 100 / 120 / 150 / 485	0,60	BM6F	6221	11	7683
ST 160 / 160 A, ST 175 G, ST 185 / 285	0,60	BPM6F	5950	-	-
ST 165 / 175 BC / 185 BC, ST 200 / 210 / 275	0,60	BM6F	6221	11	7683
ST 285 BC, ST 310	0,60	BM6F	6221	11	7683
ST 400	0,60	BM7A	6521	10	6793
SX 135 / 155	0,70	BPM6F	5950	-	-
UT2000 Series Mot. Powerstroke 25cc	0,60	BPMR7A	4626	02	5959
UT32600, UT32650 Mot. 2 tps 26cc	0,60	BPMR8Y	2218	-	-
UT41002 Mot. 2 tps 25cc	0,60	BPMR7A	4626	02	5959
XL	0,60	BM6A	5921	01	5478
XLBC4	0,60	BM7A	6521	10	6793

HOMELITE - Générateurs

176 B140A	0,60	B2-LM	1147	06	4740
176 R142A	0,60	BPR6HS	7022	-	-
178 H148	0,70	BPR5ES	7422	03	6854
178 V152	0,70	BKR5E	7938	07	4803
180 HIE63	0,70	BPR5ES	7422	03	6854
180 R162 / 180 RIE162	0,60	BR6HS	3922	-	-
190 HY50	0,60	BR2-LM	5798	06	4740
CG 4800-178H148 / 5200, CG 6300-180H163	0,70	BPR5ES	7422	03	6854
CGE 6300-180HIE63, CHY 5000-190HHY50	0,60	BR2-LM	5798	06	4740
Culasse Ø18mm	0,60	WR5	2438	-	-
E 300	0,40	CM-6	5812	-	-
EH 550 HD / 2500 HD / 4400 HD	0,60	BR2-LM	5798	06	4740
EHE 4400 HD / EHE 5500 HD, EHRL 4400 HD	0,60	BR2-LM	5798	06	4740
HG 3500 / HGE 3500	0,60	BR2-LM	5798	06	4740
HG 600, HG 50-1400 / 50-2000 / 50-2500	0,60	BR6HS	3922	-	-
HL 2500 / HL 4400 / HLE 4400 / LR 2500 / 4400	0,60	BR2-LM	5798	06	4740
LR 5500 / LRE 5500, LRE 4400, LRI 2500 / 4400	0,60	BR2-LM	5798	06	4740
LRI 5500, LRIE 4400 / 5500	0,60	BR2-LM	5798	06	4740
Mot. B&S 5 / 7 / 8 / 10 / 11 hp	0,60	BR2-LM	5798	06	4740

Modèle

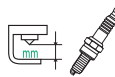
 N° STOCK BOÎTE
 N° BLISTER
 N° STOCK BLISTER

HOMELITE - Générateurs				
Mot. B&S Vanguard 9 hp	0,70	BKR5E	7938	07 4803
Mot. Homelite	0,60	BR6S	3522	09 6048
Mot. Robin 7.6 hp, Mot. Yamaha	0,60	BPR6HS	7022	- -
Mot. Robin 11 hp	0,60	BR6HS	3922	- -
UT 905700 MZ300 Yamaha	0,80	BPR4ES	7222	- -

HOMELITE - Outils Divers				
HBL 26 BV, HBP 30, HBV 30 / 30A	0,60	BPMR7A	4626	02 5959
HCP 254	0,70	BPMR7A	4626	02 5959
HHT 2655	0,60	BPMR7A	4626	02 5959
HPW 2200	0,60	BR6HS	3922	- -
HT 17 / 21, HX 16	0,60	BPMR7A	4626	02 5959

HOMELITE - Tondeuses				
45 STD / DLX	0,60	B2-LM	1147	06 4740
HBM 21P5-21, HCM 20 / 20P5 / 20P5G	0,60	B2-LM	1147	06 4740
HMB 21 P4 / 21 P5 I	0,60	B2-LM	1147	06 4740
HSB 21 / 21 P5 / 21 P5 EG	0,70	BR2-LM	5798	06 4740
HSC20-2, HSD20-2/P-2	0,70	BR2-LM	5798	06 4740
HSD 20 / 20P / 20P5 / 20V / 20K	0,70	BR2-LM	5798	06 4740
HSD 20P-2 / 20-2	0,80	B2-LM	1147	06 4740
Mot. B&S	0,70	B2-LM	1147	06 4740
Mot. Kohler	0,80	B-6L	3212	- -
Mot. MSB21 / MSB21P5	0,70	B2-LM	1147	06 4740
Mot. Yard Trac	0,70	B-4	3210	- -
RE1030E, RE1230E, RE830, RE830E	0,70	B2-LM	1147	06 4740
RidingTractor - Mot. B&S	0,80	BMR6A	7421	01 5478

HOMELITE - Tronçonneuses				
35SL	0,60	BM7A	6521	10 6793
66, 80	0,60	B6S	3510	09 6048
135	0,60	BM7A	6521	10 6793
150	0,60	BMR6F	2144	11 7683
180	0,80	BPMR6F	1270	- -
190	0,60	BMR6F	2144	11 7683
192, 200	0,80	BPMR6F	1270	- -
205	0,60	BPMR7A	4626	02 5959
240, 240SL	0,60	BMR6F	2144	11 7683
240SL	0,60	BPM6F	5950	- -
250, 290, 300, 340	0,60	BPMR7A	4626	02 5959
330SL	0,60	BPM6F	5950	- -
360SL	0,60	BM7F	6421	- -
410SL	0,60	BPM6F	5950	- -
550SL	0,60	BM7F	6421	- -
650, 750	0,80	BMR7A	4226	10 6793
750W, 945 / 955, Big Red SXL	0,60	BM7A	6521	10 6793
1010	0,60	BMR7A	4226	10 6793
1050, 1130G	0,60	BM7A	6521	10 6793
2100 Super	0,80	BMR7A	4226	10 6793
2100G, 2100S, 3100G	0,60	BM7A	6521	10 6793
8800	0,60	BPMR7A	4626	02 5959
C72	0,80	BR6S	3522	09 6048
CS-40	0,60	BPMR6F	1270	- -
CSP 3314 / 3316	0,60	BPMR7A	4626	02 5959
CSP 4513 / 4518 / 4520	0,60	BMR7A	4226	10 6793
D3300 / D3350B / D3800 / D3850B	0,60	BPMR7A	4626	02 5959
DM 20	0,60	BM7A	6521	10 6793
DM 40 / 54	0,60	BPMR6F	1270	- -
EZ, EZAO	0,60	BM7F	6421	- -
HCS 3335 / 3335 C / 3340 / 4040 / 4040 C	0,60	BPMR7A	4626	02 5959
HCS 4545 / 4545 C, i3350 b / i3850 b	0,60	BPMR7A	4626	02 5959
LX30 / Little Red XL	0,60	BPMR6F	1270	- -
MP38 / MP88 / Old Blue SXL	0,60	BM7A	6521	10 6793
Super 2100	0,60	BM7F	6421	- -
Super 2100G, Super 2100S, Super 3100G	0,60	BM7A	6521	10 6793
Super Wiz 55 / 66 / 80	0,80	BR6S	3522	09 6048
Super XL, Super XL-AO	0,60	BM7A	6521	10 6793
SXL 922SL, SXL AO	0,60	BMR7A	4226	10 6793
SXL MiniAO	0,60	BM7F	6421	- -
UT10640, UT10660, UT10680 Mot. 35cc	0,60	BPMR8Y	2218	- -
V1 Super 2 SL	0,60	BM6F	6221	11 7683
V1 Super 2, V1 Super 2 XL	0,80	BMR6F	2144	11 7683
V1123	0,60	BM7A	6521	10 6793

Modèle

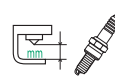
 N° STOCK BOÎTE
 N° BLISTER
 N° STOCK BLISTER

V1 130SL	0,60	BR6S	3522	09 6048
V1944, V 1955	0,60	BM7A	6521	10 6793
XL 1 AO	0,60	BM7F	6421	- -
XL 12, XL 100A	0,70	BMR6A	7421	01 5478
XL 76	0,60	BR6S	3522	09 6048
XL 98 / 98 D, XL 123, XL 924A, XL 925	0,60	BM7A	6521	10 6793
XL Auto, XL Mini	0,60	BM7F	6421	- -
XL-AO, XLBC 4	0,60	BM7A	6521	10 6793
Z330	0,60	BPMR7A	4626	02 5959
Z2240B, Z3330	0,60	BPM7A	7321	02 5959
Z3350, Z3350B, Z3850B	0,60	BPMR7A	4626	02 5959

HOMELITE-JACOBSEN - Générateurs				
D 630 / 730 / 830	0,80	BPMR6F	1270	- -
Séries ZR 625 / 725 / 825 / 830 / 885	0,80	BPMR6F	1270	- -
ST 80 / 90 / 100 / 120 / 150 / 160	0,80	BPMR6F	1270	- -
ST 175 / 185 / 200 / 275 / 285 / 385 / 485	0,80	BPMR6F	1270	- -

HOMESTEADER - Tondeuses				
Mot. B&S	0,60	B2-LM	1147	06 4740
Mot. Kohler 16hp	0,80	B-6L	3212	- -

HOMKO - Tondeuses				
Tous modèles	0,70	BR2-LM	5798	06 4740

HONDA - Débroussailleuses				
HH 25D60	0,80	CMR5H	7599	- -
HHT 22 S - Mot. GX22 1 hp	0,80	CR5HSB	6535	- -
HHE 31 CA - Mot. GX31 1.5 hp	0,80	CR5HSB	6535	- -
HHT 25 / S, 35S - Mot. GX25 1.1 hp	0,80	CMR5H	7599	- -
HHT 25 SLTA	0,80	C7HSA	4629	- -
HHT 31 U Mot. GX31 1.5 hp	0,80	CR5HSB	6535	- -
HTT 31 S Mot. GX31 1.5 hp	0,60	CR5HSB	6535	- -
UM 17	0,60	BMR4A	5728	- -
UM 21 Mot. GXV160 / E, UM 515	0,80	BPR5ES	7422	03 6854
UM 516C	0,80	BPR6ES	7822	04 7678
UM 536 / B	0,60	BPR4ES	7222	- -
UM 536 EE / EBE, 616 EBE / EE	0,80	BPR5ES	7422	03 6854
UM 616 / B	0,60	BPR4ES	7222	- -
UM 2160 / B, 24, 2460 / B, 28	0,80	BPR5ES	7422	03 6854
UMK 25	0,80	C7HSA	4629	- -
UMK 422 / K1 - Mot. GX22 1 hp	0,80	CR5HSB	6535	- -
UMK 422 D / J / S / LNC / LNU / LT4	0,80	CR5HSB	6535	- -
UMK 422 LTA / LNA	0,80	C7HSA	4629	- -
UMK 422 LTE / UE / UN4C / UNU / UT4E	0,80	CR5HSB	6535	- -
UMK 425 L3E / LE / U3E / UE	0,80	CMR5H	7599	- -
UMK 431 / K1 - Mot. GX31 1.5 hp	0,80	CR5HSB	6535	- -
UMK 431 D / J / L3E / LE / LEB	0,80	CR5HSB	6535	- -
UMK 431 LNA / LTA / UNA / UNBA	0,80	C7HSA	4629	- -
UMK 431 U3E / UE / UEB	0,80	CR5HSB	6535	- -
UMK 435 L3E / U3E / UE	0,80	CR5HSB	6535	- -
UMK 435 UT4E / LT4E / LTE, UMR 425 / LE	0,80	CMR5H	7599	- -
UMR 431 LTA	0,80	CR5HSB	6535	- -
UMS 425 LE	0,70	CMR5H	7599	- -
UMT 20 S / 24 D / 28 D / 32 D	0,70	BPMR6A	6726	08 5063
UMT 24 S	0,80	CR5HSB	6535	- -
UMT 32 FX, 41 DF, 51 DF / FX	0,70	BPMR6A	6726	08 5063
UMT 40 DP, 45 DP	0,70	BPMR7A	4626	02 5959



HONDA - Générateurs				
4500K1 - Mot. G400K1	0,60	BPR4HS	7823	- -
BF 2A (98-)	0,70	BMR4A	5728	- -
BF 5F (98-)	0,70	BPR5ES	7422	03 6854
E 100, E 300	0,60	C6HSA	3228	- -
E 400	0,60	CM-6	5812	- -
E 300 / K1 / K2 K3 - Mot. GE 300 8 hp	0,60	CM-6	5812	- -
E 1000 / 1500 - Mot. G40 4 hp	0,60	B6HS	4510	- -
E 1500 - Mot. G41 4 hp	0,60	B-4H	4110	- -
E 1500 K1 / K2 / K3 - Mot. G42 4 hp	0,60	C6HSA	3228	- -
E 1500 K4 CDI - Mot. G200 5 hp	1,00	BPR4HS-10	5024	- -
E 1500 K4 CDN - Mot. G200 5 hp	0,60	BR4HS	3322	- -
E 2000 - Mot. G65 6.5 hp	0,60	BR6HS	3922	- -
E 2500 - Mot. G300 8 hp	0,60	B-4H	4110	- -

Modèle		N°	STOCK BLISTER STOCK		
			BOÎTE	BLISTER	BLISTER
E 2500 K1 / K2 / K3 - Mot. G65 6.5 hp	0,60	BR6HS	3922	-	-
E 2500 K4 - Mot. G300 8 hp	0,60	BR4HS	3322	-	-
E 2500 K4 avec CDI	1,00	BPR4HS-10	5024	-	-
E 3500 - Mot. G400 10 hp	0,60	B-4H	4110	-	-
E 3500 - Mot. G80 6.5 hp	0,60	BR6HS	3922	-	-
E 3500 CDI. IGN	1,00	BPR4HS-10	5024	-	-
E 3500 K1 - Mot. G400K1 10 hp	0,60	BR4HS	3322	-	-
E 4500 - Mot. G400K1 10 hp, E 4500 (G400), CDN	1,00	BPR4HS-10	5024	-	-
E 80 / 600 / 800 A / 900	0,60	C6HSA	3228	-	-
EB 1200 X - Mot. GX110	0,60	BPR6ES	7822	04	7678
EB 1300 X	0,70	BP6ES	7811	04	7678
EB 1400 X	0,60	BPR6ES	7822	04	7678
EB 1500 - Mot. GE200	1,00	BPR4HS-10	5024	-	-
EB 1500 X	0,60	BPR6ES	7822	04	7678
EB 1600	0,60	BPR4HS	7823	-	-
EB 1800	1,00	BPR4HS-10	5024	-	-
EB 1800 X	0,70	BPR6ES	7822	04	7678
EB 1900 - Mot. GE200	1,00	BPR4HS-10	5024	-	-
EB 1900 X - Mot. GX140	0,70	BPR6ES	7822	04	7678
EB 2000 I - Mot. GX100	0,70	CR5HSB	6535	-	-
EB 2200 X - Mot. GX140 5 hp, EB 2500	0,70	BPR6ES	7822	04	7678
EB 2500 C	0,70	BPR5ES	7422	03	6854
EB 2500 X, EB 2500 XK1 - Mot. GX160K1 5.5 hp	0,70	BPR6ES	7822	04	7678
EB 2800 - Mot. GE300	1,00	BPR4HS-10	5024	-	-
EB 3000 - Mot. G300 7 hp	0,60	BR4HS	3322	-	-
EB 3000 C - Mot. GX200 6.5 hp	0,70	BPR6ES	7822	04	7678
EB 3000 CK1 / 3000 X / 3300 S	0,70	BPR5ES	7422	03	6854
EB 3500 X - Mot. GX240 8 hp	0,70	BPR6ES	7822	04	7678
EB 3500 XK1 - Mot. GX240K1	0,70	BPR6ES	7822	04	7678
EB 3800 - Mot. G400	1,00	BPR4HS-10	5024	-	-
EB 3800 X - Mot. GX240 8 hp	0,70	BPR6ES	7822	04	7678
EB 4000 - Mot. G400K1 10 hp	0,60	BR4HS	3322	-	-
EB 4000 X	0,70	BPR5ES	7422	03	6854
EB 4500	0,70	BPR6ES	7822	04	7678
EB 4500 S	0,70	BPR5ES	7422	03	6854
EB 4500 X, EB 5000	0,70	BPR6ES	7822	04	7678
EB 5000 I / 5000 IS - Mot. GX340 11 hp	0,70	BPR5ES	7422	03	6854
EB 5000 X - Mot. GX340 11 hp (-1253117)	1,10	BPR5ES-11	4424	-	-
EB 5000 X - Mot. GX340 11 hp (1253118)	0,70	BPR5ES	7422	03	6854
EB 5000 XK1 / 5000 XK2 - Mot. GX340K1 11 hp	0,70	BPR5ES	7422	03	6854
EB 6500, EB 6500 SX - Mot. GX390K1 13 hp	0,70	BPR5ES	7422	03	6854
EB 6500 X - Mot. GX390 13 hp	0,70	BPR6ES	7822	04	7678
EB 7000 I / 7000 IS - Mot. GX390 13 hp	0,70	BPR5ES	7422	03	6854
EB 10000 - Mot. GX630	0,80	ZFR5F	5165	-	-
EB 11000 - Mot. GX 620 20 hp	0,70	BPR6ES	7822	04	7678
EB 11000 K1 - Mot. GX 620 20 hp	0,60	ZGR5A	5839	-	-
EBK 1600 / 2000	1,00	BPR4HS-10	5024	-	-
EBK 2500 K1, EBK 2600, EBK 3600 / 3600 K1	0,60	BR4HS	3322	-	-
EC 1000	0,60	BR4HS	3322	-	-
EC 1500 (G200) avec CDI, CDN	1,00	BPR4HS-10	5024	-	-
EC 1500 (G42)	0,60	BR6HS	3922	-	-
EC 1500 K4	0,60	BR4HS	3322	-	-
EC 2000	0,90	BPR6ES	7822	04	7678
EC 2100 / 2100 C / 2200 / 2200 L	0,60	BPR6ES	7822	04	7678
EC 3600	0,90	BPR6ES	7822	04	7678
EC 4000	0,60	BPR6ES	7822	04	7678
EC 4500	0,70	BPR6ES	7822	04	7678
EC 4500 P	0,60	BPR6ES	7822	04	7678
EC 5000	0,90	BPR6ES	7822	04	7678
EC 6000	0,60	BPR6ES	7822	04	7678
ECK 1500	0,60	BR4HS	3322	-	-
ECM 2800, ECMT 6500 / 6500 P	0,70	BPR6ES	7822	04	7678
ECMT 7000	0,90	BPR6ES	7822	04	7678
ECT 6500 / 6500P	0,60	BPR6ES	7822	04	7678
ECT 7000 / 7000 P	0,90	BPR6ES	7822	04	7678
ED 150	0,60	CM-6	5812	-	-
ED 300 (-83)	1,00	BPMR6A-10	1029	-	-
ED 300 (84-)	1,00	BPMR4A-10	6328	-	-
ED 300 (S/N ->1138369)	1,00	BPMR6A-10	1029	-	-
ED 300 (S/N 1138370->)	1,00	BPMR4A-10	6328	-	-
ED 300 K1	1,00	BPMR6A-10	1029	-	-
ED 400	0,60	BMR4A	5728	-	-
ED 1000 K1 / K2 / K3 - Mot. G42 4 hp	0,60	C6HSA	3228	-	-
ED 1000 K4 - Mot. G200 5 hp	0,60	BR4HS	3322	-	-
ED 1000 X	0,70	BPR6ES	7822	04	7678
EG 550	0,60	BMR4A	5728	-	-
EG 850	0,60	BR4HS	3322	-	-

Modèle		N°	STOCK BLISTER STOCK		
			BOÎTE	BLISTER	BLISTER
EG 850 X	0,60	BPR6ES	7822	04	7678
EG 850 Z, EG 1000 (G150)	0,60	BR4HS	3322	-	-
EG 1000 (G28)	0,60	C6HSA	3228	-	-
EG 1000 (G35)	0,60	BR6HS	3922	-	-
EG 1000 A - Mot. GE150 3.5 hp	0,60	BR4HS	3322	-	-
EG 1000 X, EG 1200	0,60	BPR6ES	7822	04	7678
EG 1200 X - Mot. GX110 / 120K1	0,60	BPR6ES	7822	04	7678
EG 1200 Z	0,60	BR4HS	3322	-	-
EG 1400	0,60	BP6ES	7811	04	7678
EG 1400 X - Mot. GX110 3.5 hp	0,60	BPR6ES	7822	04	7678
EG 1400 XK1 - Mot. GX120K1 4 hp	0,60	BPR6ES	7822	04	7678
EG 1400 Z, EG 1500	0,60	BR4HS	3322	-	-
EG 1400 Z - Mot. GE150 3.5 hp (1380695-)	0,60	BR4HS	3322	-	-
EG 1500 - Mot. G41 4 hp	0,60	B-4H	4110	-	-
EG 1500 (G200) avec CDI, CDN	1,00	BPR4HS-10	5024	-	-
EG 1500 (G42)	0,60	BR6HS	3922	-	-
EG 1500 K3 - Mot. G42 4 hp	0,60	C6HSA	3228	-	-
EG 1500 K4 - Mot. G200 5 hp	0,60	BR4HS	3322	-	-
EG 1500 X	0,60	BPR6ES	7822	04	7678
EG 1500 Z, EG 1800	0,60	BR4HS	3322	-	-
EG 1800 X	0,60	BPR6ES	7822	04	7678
EG 1800 Z - Mot. G200 5 hp (1556008-)	0,60	BR4HS	3322	-	-
EG 1900 X (GX140)	0,60	BPR6ES	7822	04	7678
EG 1900 Z, EG 200 Z - Mot. G200 5 hp (1556008-)	0,60	BR4HS	3322	-	-
EG 2000 / 2200 X	0,60	BPR6ES	7822	04	7678
EG 2200 X - Mot. GX140 5 hp	0,60	BPR6ES	7822	04	7678
EG 2200 Z	0,60	BR4HS	3322	-	-
EG 2500 XK1 - Mot. GX160K1 5.5 hp	0,60	BPR6ES	7822	04	7678
EG 3000	0,60	BPR5ES	7422	03	6854
EG 3000 X / 3500 X	0,60	BPR6ES	7822	04	7678
EG 3500 X - Mot. GX240 8 hp	0,70	BPR5ES	7422	03	6854
EG 3500 XK1 - Mot. GX240K1 8 hp	0,70	BPR5ES	7422	03	6854
EG 3600 CL	0,90	BPR5ES	7422	03	6854
EG 4000	0,60	BR4HS	3322	-	-
EG 4000 CL	0,70	BPR5ES	7422	03	6854
EG 4000 CL GX270T2	0,80	BPR5ES	7422	03	6854
EG 4500	0,60	BPR6ES	7822	04	7678
EG 4500 CL	0,90	BPR5ES	7422	03	6854
EG 4500 X	1,10	BPR5ES-11	4424	-	-
EG 4500 X (GX340 CDI)	0,80	BPR5ES	7422	03	6854
EG 5000	0,60	BPR6ES	7822	04	7678
EG 5000 CL	0,70	BPR5ES	7422	03	6854
EG 5000 CL GX390T2	0,80	BPR5ES	7422	03	6854
EG 5000 X - Mot. GX340 11 hp (-1253117)	1,10	BPR5ES-11	4424	-	-
EG 5000 X - Mot. GX340 11 hp (1253118)	0,70	BPR5ES	7422	03	6854
EG 5000 XK1 - Mot. GX340K1 11 hp	0,70	BPR5ES	7422	03	6854
EG 5500 CL	0,90	BPR5ES	7422	03	6854
EG 650 - Mot. G100K1 2.5 hp	0,60	BMR4A	5728	-	-
EG 6500 CL	0,70	BPR5ES	7422	03	6854
EG 6500 CL GX390T2	0,80	BPR5ES	7422	03	6854
EGK 600	0,70	BM4A	5628	-	-
EGK 1000 / 1200 / 1500 / 1600 / 2000 / 2600	0,60	BR4HS	3322	-	-
EGK 2600 K1, EGK 3600 / 3600 K1	0,60	BR4HS	3322	-	-
EJ 3	0,70	BPR6HS	7022	-	-
EL 1500K1, EL 5000 - Mot. GX360 13 hp	1,00	BPR6HS-10	2633	-	-
EM 25 / 30	0,50	BPR6ES	7822	04	7678
EM 50 is	0,60	BPR5ES	7422	03	6854
EM 65 is	0,90	BPR5ES	7422	03	6854
EM 70 is	0,60	BPR5ES	7422	03	6854
EM 300	0,60	C6HSA	3228	-	-
EM 300 / K1 / K2 / K3 - Mot. GE300 8 hp	0,60	CM-6	5812	-	-
EM 400	0,60	C6HSA	3228	-	-
EM 400 - Mot. GE300 8 hp Ø 10 mm	0,60	CM-6	5812	-	-
EM 400 - Ø 14 mm	1,00	BPMR6A-10	1029	-	-
EM 400 K1 - Mot. GE300 8 hp Ø 10 mm	0,60	CM-6	5812	-	-
EM 500 (-1138369)	1,00	BPMR6A-10	1029	-	-
EM 500 (1138370-), EM 500 K1	1,00	BPMR4A-10	6328	-	-
EM 650 - Mot. GE100 2.2 hp	0,70	BMR4A	5728	-	-
EM 1000 F (97-)	0,60	BR4HS	3322	-	-
EM 1200 X - Mot. GX110, EM 1400 X	0,60	BPR6ES	7822	04	7678
EM 1500	1,00	BPR4HS-10	5024	-	-
EM 1500 X	0,60	BPR6ES	7822	04	7678
EM 1600 - Mot. GE200 5 hp	0,60	BR4HS	3322	-	-
EM 1600 K4 - Mot. G200 (1556008-) 5 hp	0,60	BR4HS	3322	-	-
EM 1600 X - Mot. GX140 5 hp	0,60	BPR6ES	7822	04	7678
EM 1800 G200 (1556008-) 5 hp	0,60	BPR4HS	7823	-	-
EM 1800 GE200 5 hp	0,60	BPR4HS	7823	-	-

HONDA - Générateurs				
EM 1800 X - Mot. GX140 5 hp	0,60	BPR6ES	7822	04 7678
EM 1800 XK1 - GX160K1 5.5 hp	0,60	BPR6ES	7822	04 7678
EM 1900	1,00	BPR4HS-10	5024	- -
EM 1900 X	0,70	BPR6ES	7822	04 7678
EM 2200 - Mot. G200 5 hp	1,00	BPR4HS-10	5024	- -
EM 2200 X - Mot. GX140 5 hp	0,60	BPR6ES	7822	04 7678
EM 2500 C	0,70	BPR5ES	7422	03 6854
EM 2500 XK1 - GX160K1 5.5 hp	0,60	BPR6ES	7822	04 7678
EM 2500 XK1 - Mot. GX240K1 8 hp	0,70	BPR5ES	7422	03 6854
EM 3000 - Mot. G300 8 hp	1,00	BPR4HS-10	5024	- -
EM 3000 C	0,60	BPR5ES	7422	03 6854
EM 3000 X / 3000 SX	0,70	BPR5ES	7422	03 6854
EM 3500 X / 3500 SX - GX240 8 hp	0,60	BPR5ES	7422	03 6854
EM 3500 XK1 - GX240K1 8 hp	0,70	BPR5ES	7422	03 6854
EM 3800 SX - GX240 8 hp	0,60	BPR5ES	7422	03 6854
EM 4000 - Mot. G400K1 10 hp	1,00	BPR4HS-10	5024	- -
EM 4000 S IGX270	0,80	BPR5ES	7422	03 6854
EM 4000 SX	0,70	BPR5ES	7422	03 6854
EM 4500	0,70	BPR6ES	7822	04 7678
EM 4500 CX / 4500 CXS / 4500 SX	0,70	BPR5ES	7422	03 6854
EM 4500 X	0,70	BPR6ES	7822	04 7678
EM 5000	0,70	BPR6ES	7822	04 7678
EM 5000 IS - GX340 11 hp (-1253117)	1,10	BPR5ES-11	4424	- -
EM 5000 IS - GX340 11 hp (1253118)	0,70	BPR5ES	7422	03 6854
EM 5000 SX - GX340 11 hp (-1253117)	1,10	BPR5ES-11	4424	- -
EM 5000 SX - GX340 11 hp (1253118)	0,70	BPR5ES	7422	03 6854
EM 5000 SX - Mot. IGX390	0,80	BPR5ES	7422	03 6854
EM 5000 SXK1 / SXK2 - Mot. GX340K1 11 hp	0,70	BPR5ES	7422	03 6854
EM 5000 X - GX340 11 hp (-1253117)	1,10	BPR5ES-11	4424	- -
EM 5000 X - GX340 11 hp (1253118)	0,70	BPR5ES	7422	03 6854
EM 5500 CX / 5500 CXS, EM 6000	0,70	BPR5ES	7422	03 6854
EM 6000 GPA - Mot. GX390K1 13 hp	0,60	BPR6ES	7822	04 7678
EM 6500 SX Mot. IGX390	0,80	BPR5ES	7422	03 6854
EM 6500 SXK1 - Mot. GX390K1 13 hp	0,60	BPR6ES	7822	04 7678
EM 6500 X	0,70	BPR5ES	7422	03 6854
EM 7000 IS - Mot. GX390K1 13 hp	0,60	BPR6ES	7822	04 7678
EMK 1600 / 2000	0,60	BPR4HS	7823	- -
EMS 2800 (GE300), EMS 3000, EMS 3800 (G400)	1,00	BPR4HS-10	5024	- -
EMS 4000 / 4500 - Mot. G400K1 10 hp	1,00	BPR4HS-10	5024	- -
EN 2000 / 2500 - Mot. GC160 5 hp	0,70	BPR6ES	7822	04 7678
EN 3500 - Mot. GX240K1 8 hp	0,70	BPR5ES	7422	03 6854
EN 5000 - Mot. GX340K1 11 hp	0,70	BPR5ES	7422	03 6854
EP 2500 CX	0,70	BPR6ES	7822	04 7678
EP 2500 CX1	0,70	BPR5ES	7422	03 6854
ER 400 - Mot. GE300 8 hp	0,60	CM-6	5812	- -
ER 1500 Mot. G41 4 hp	0,60	B-4H	4110	- -
ES 3500 - Mot. G80 6.5 hp	0,60	BR6HS	3922	- -
ES 3500 (G400) avec CDI	1,00	BPR4HS-10	5024	- -
ES 3500 (G400), CDN	0,60	BR4HS	3322	- -
ES 3500 K1/K2 - Mot. G400K1 10 hp	0,60	BR4HS	3322	- -
ES 4500 - Mot. G400K1 10 hp	1,00	BPR4HS-10	5024	- -
ES 4500 (G400), CDN	1,00	BPR4HS-10	5024	- -
ES 5500 (GX360)	1,00	BPR6HS-10	2633	- -
ES 5500 K1 (GX360K1)	0,60	BPR6HS	7022	- -
ES 6500 - Mot. GX360 13 hp	1,00	BPR6HS-10	2633	- -
ES 6500 K1 / K2 - Mot. GX360K1 13 hp	0,70	BPR6HS	7022	- -
ET 4500 - Mot. G400K1 10 hp	1,00	BPR4HS-10	5011	- -
ET 4500 K1	1,00	BPR4HS-10	5024	- -
ET 4500 X / 4500 SX	0,60	BPR6ES	7822	04 7678
ET 5000	0,60	B6ES	7310	- -
ET 5000 Z	0,70	BPR6HS	7022	- -
EU 19 i	0,70	CR5HSB	6535	- -
EU 20	0,70	CR4HSB	4695	- -
EU 26 i / EU 2600 i	0,70	BPR5ES	7422	03 6854
EU 30 i	0,60	BPR6ES	7822	04 7678
EU 30 is	0,70	BPR5ES	7422	03 6854
EU 2000 I / 2000 IA - Mot. GX100 3 hp	0,70	CR5HSB	6535	- -
EU 3000 i	0,70	BPR6ES	7822	04 7678
EU 3000 IS / 3000 ISA - Mot. GX200 6.5 hp	0,60	BPR6ES	7822	04 7678
EU 3000 K1 / 3000 S	0,70	BPR5ES	7422	03 6854
EU 65 is	0,90	BPR5ES	7422	03 6854
EU 6500 IS - Mot. 6.5 hp	0,70	BPR5ES	7422	03 6854
EU 6500 is (GX390)	0,70	BPR6ES	7822	04 7678
EU 6500 is (GX390K1)	0,70	BPR5ES	7422	03 6854
EUX 1000 - Mot. GXH50 2.5 hp	0,60	CR5HSB	6535	- -

EV 3600	1,00	BPR6HS-10	2633	- -
EV 3610	0,70	BPR2HS	7626	- -
EV 4000 - Mot. G400K1 10 hp	1,00	BPR6HS-10	2633	- -
EV 4010 / 4010 RV - Mot. GX360K1 13 hp	0,70	BPR4HS	7823	- -
EV 5010	0,70	BPR6HS	7022	- -
EV 6010 / 6010 RV - Mot. GX360K1 13 hp	0,70	BPR4HS	7823	- -
EVD 4010 - Mot. GX360K1 13 hp	0,70	BPR4HS	7823	- -
EVD 4010 RV 13 hp GX360K1	0,60	BPR4HS	7823	- -
EW 140 - Mot. GX240K1 8 hp	0,70	BPR5ES	7422	03 6854
EW 170 - Mot. GE400 10 hp	0,60	BR4HS	3322	- -
EW 171 - GX340 11hp (->1253117)	1,10	BPR5ES-11	4424	- -
EW 171 - GX340 11hp (1253118->)	0,70	BPR5ES	7422	03 6854
EW 171 - X340 11hp (1253118->)	1,10	BPR5ES-11	4424	- -
EW 171 K1 - Mot. GX340K1	0,70	BPR5ES	7422	03 6854
EX 7 (-1113036)	0,70	CR5HSB	6535	- -
EX 7 (1113037)	0,70	CR4HSB	4695	- -
EX 100 / 1000	0,60	BR4HS	3322	- -
EX 350 - Mot. GE35 3.5 hp	0,60	BMR6A	7421	01 5478
EX 400, EX 500 (-83) (-1138369)	1,00	BPMR6A-10	1029	- -
EX 500 (84-) (1138370)	1,00	BPMR4A-10	6328	- -
EX 650 - Mot. GE100 2.2 hp	0,60	BMR4A	5728	- -
EX 700 C - Mot. GXH50	0,70	CR5HSB	6535	- -
EX 800 / 800 K1 - Mot. G100K1 2.5 hp	1,00	BPR4HS-10	5024	- -
EX 900	0,60	BR4HS	3322	- -
EX 1000 - Mot. G101A / G101A2 2.2 hp	0,60	BMR4A	5728	- -
EX 1900 (-89), EX 2100 (-89), EX 2200 X (-89)	0,60	BPR6ES	7822	04 7678
EX 2200 - Mot. GX140 5 hp	0,60	BPR6ES	7822	04 7678
EX 2400 (-89), EX 3000 (-89)	0,60	BPR6ES	7822	04 7678
EX 3000 (90)	0,60	BMR6A	7421	01 5478
EX 3000 S / 3000 SK1 - Mot. GX240K1 8 hp	0,60	BPR5ES	7422	03 6854
EX 3300	0,70	BPR6ES	7822	04 7678
EX 3300 S 8 hp GX240K1	0,60	BPR5ES	7422	03 6854
EX 3300 SK1 8 hp GX240K1	0,60	BPR5ES	7422	03 6854
EX 4000 / 4000 K1	0,70	BPR5ES	7422	03 6854
EX 4000 S	1,10	BPR5ES-11	4424	- -
EX 4000 S (GX340)	0,70	BPR5ES	7422	03 6854
EX 4500	0,70	BPR6ES	7822	04 7678
EX 4500 K1 (mot. 1253118->)	0,70	BPR5ES	7422	03 6854
EX 4500 S - Mot. GX340 (-> 1253117)	1,10	BPR5ES-11	4424	- -
EX 4500 S - Mot. GX340 (1253118->)	0,70	BPR5ES	7422	03 6854
EX 4500 SK1 - Mot. GX340K1 11 hp	0,70	BPR5ES	7422	03 6854
EX 5500 - Mot. GX360 13 hp	1,00	BPR6HS-10	2633	- -
EX 5500 K0	0,60	BPR6HS	7022	- -
EX 5500 K1 / 5500 K2 - Mot. GX360K1 13 hp	0,60	BPR6HS	7022	- -
EX 6500 - Mot. GX360K1 13 hp	1,00	BPR6HS-10	2633	- -
EX 6500 K1 - Mot. GX360K1 13 hp	0,70	BPR4HS	7823	- -
EXW 171 S - GX340 11hp (->1253117)	1,10	BPR5ES-11	4424	- -
EXW 171 S - GX340 11hp (1253118->)	0,70	BPR5ES	7422	03 6854
EXW 171 S - X340 11hp (1253118->)	1,10	BPR5ES-11	4424	- -
EZ 1400 (97) - Mot. GX120K1 4 hp	0,70	BPR6ES	7822	04 7678
EZ 1500-JH/NH (97-), EZ 1800 (97-)	0,70	BPR6ES	7822	04 7678
EZ 2200	0,70	BPR5ES	7422	03 6854
EZ 2300-JH/NH (97-)	0,70	BPR6ES	7822	04 7678
EZ 2500 (97) - Mot. GX160K1 5.5 hp	0,70	BPR6ES	7822	04 7678
EZ 3500/-S (97-) - Mot. GX240K1 8 hp	0,70	BPR5ES	7422	03 6854
EZ 4500	1,10	BPR5ES-11	4424	- -
EZ 4500-S (97-)	0,70	BPR5ES	7422	03 6854
EZ 5000/-S (97-) - Mot. GX340K1 11 hp	0,70	BPR5ES	7422	03 6854
G 3 T / G25 / G28	0,60	C6HSA	3228	- -
G 20 / 30 / 35	0,60	BR6HS	3922	- -
G 35 L	0,60	B6HS	4510	- -
G 40	0,60	BR6HS	3922	- -
G 100	0,70	BM6A	5921	01 5478
G 100 avec CDI, G 100 K1	0,60	BMR4A	5728	- -
G 100 K2	0,70	BPMR4A	6028	- -
G 101	0,60	BR4HS	3322	- -
G 150 avec CDI	1,00	BP4HS-10	5011	- -
G 150 K1	0,60	B-4H	4110	- -
G 150 L	0,60	BR4HS	3322	- -
G 150 LX	1,00	BPR4HS-10	5024	- -
G 150 S / 150 W	0,60	BR4HS	3322	- -
G 200 avec CDI	1,00	BPR4HS-10	5024	- -
G 200 K1	0,60	B-4H	4110	- -
G 200 L	0,60	BR4HS	3322	- -
G 200 LX	1,00	BPR4HS-10	5024	- -
G 200 S / 200 W	0,60	BR4HS	3322	- -
G 300 avec CDI	1,00	BPR4HS-10	5024	- -

Modèle		N°	N°	N°	Modèle		N°	N°	N°		
										STOCK	BLISTER
G 400 K1	0,60	BPR4HS	7823	-	-	GX 200 T	0,70	BPR6ES	7822	04	7678
G 400 K1 CDI	1,00	BPR4HS-10	5024	-	-	GX 240	0,70	BPR5ES	7422	03	6854
G 42 / 45 / 50 / 65 / 80, GB 30 / 40	0,60	BR6HS	3922	-	-	GX 240 (Forte charge)	0,70	BPR6ES	7822	04	7678
GC 135 / 135 E, GC 160, GC 160 A / E / LA / LE	0,70	BPR6ES	7822	04	7678	GX 240 K1	0,70	BPR5ES	7422	03	6854
GC 190, GC 190A / LA, GCV 135	0,70	BPR6ES	7822	04	7678	GX 240 K1(Forte charge)	0,70	BPR6ES	7822	04	7678
GCV 50 / 57	0,60	CR5HSB	6535	-	-	GX 270	0,70	BPR6ES	7822	04	7678
GCV 135 E (S/N ->2218977)	0,70	BPR6ES	7822	04	7678	GX 270 T	0,90	BPR6ES	7822	04	7678
GCV 135 E (S/N 2720019->)	0,70	BPR4ES	7222	-	-	GX 270 T2	0,70	BPR5ES	7422	03	6854
GCV 135 LE (S/N ->2218977)	0,70	BPR6ES	7822	04	7678	GX 300	0,80	BP5HS	4111	-	-
GCV 135 LE (S/N 2720019->)	0,70	BPR4ES	7222	-	-	GX 340	0,70	BPR5ES	7422	03	6854
GCV 135 N2E	0,80	BPR6ES	7822	04	7678	GX 340 (Forte charge)	0,70	BPR6ES	7822	04	7678
GCV 160	0,70	BPR5ES	7422	03	6854	GX 340 K1	0,70	BPR5ES	7422	03	6854
GCV 160 (Forte charge),	0,70	BPR6ES	7822	04	7678	GX 340 K1 (Forte charge)	0,70	BPR6ES	7822	04	7678
GCV 160 A (S/N ->2218977)	0,70	BPR6ES	7822	04	7678	GX 360 K1	0,60	BPR5HS	6222	-	-
GCV 160 AO (S/N 2218978->)	0,70	BPR5ES	7422	03	6854	GX 390	0,70	BPR5ES	7422	03	6854
GCV 160 E (S/N ->2218977)	0,70	BPR6ES	7822	04	7678	GX 390 (Forte charge), GX 390 K1 / 390 T1	0,70	BPR6ES	7822	04	7678
GCV 160 E (S/N 2218978->)	0,70	BPR5ES	7422	03	6854	GX 390 T2	0,70	BPR5ES	7422	03	6854
GCV 160 LA (S/N ->2218977)	0,70	BPR6ES	7822	04	7678	GX 400	0,70	BM6A	5921	01	5478
GCV 160 LAO (S/N 2218978->)	0,70	BPR5ES	7422	03	6854	GX 440 IR	0,70	BKR5E	7938	07	4803
GCV 160 LE (S/N ->2218977)	0,70	BPR6ES	7822	04	7678	GX 610 K1 / 620 K1	0,70	ZGR5A	5839	-	-
GCV 160 LE (S/N 2218978->)	0,70	BPR5ES	7422	03	6854	GX 630 (Essence)	0,70	ZFR5F	5165	-	-
GCV 160 N2E	0,70	BPR6ES	7822	04	7678	GX 640	1,10	BPR5ES-11	4424	-	-
GCV 190	0,70	BPR5ES	7422	03	6854	GX 660 / 690 (Essence)	0,70	ZFR5F	5165	-	-
GCV 190 (Forte charge)	0,70	BPR6ES	7822	04	7678	GXV 12	0,80	BP5ES	6511	03	6854
GCV 190 A (S/N ->1693051)	0,70	BPR6ES	7822	04	7678	GXV 12 CDN	0,80	BPR5ES	7422	03	6854
GCV 190 A (S/N 1693052->)	0,70	BPR5ES	7422	03	6854	GXV 50 / 57	0,60	CR5HSB	6535	-	-
GCV 190 LA (S/N ->1693051)	0,70	BPR6ES	7822	04	7678	GXV 57 U	0,70	CR5HSB	6535	-	-
GCV 520 / 530	0,70	BPR6ES	7822	04	7678	GXV 110	0,80	B6HS	4510	-	-
GCV 520 R / 520 U / 530 R / 530 U	0,50	BPR4ES	7222	-	-	GXV 120 / 140 / 160 / 160K1	0,70	BPR5ES	7422	03	6854
GE 200	0,60	BR4HS	3322	-	-	GXV 160 H2	0,70	BPR6ES	7822	04	7678
GE 300 / 400	0,90	BPR4HS-10	5024	-	-	GXV 200 / 240	0,90	BPR5ES	7422	03	6854
GK 50 / 65	0,60	BR6HS	3922	-	-	GXV 270 / 270 K1, GXV 340 / 340 K1 / 340 K2	0,70	BPR5ES	7422	03	6854
GK 200	0,60	BR4HS	3322	-	-	GXV 340 T2	0,70	BPR6ES	7822	04	7678
GK 200 avec CDI, CDN	1,00	BPR4HS-10	5024	-	-	GXV 340 UT2 DN4	0,70	BPR5ES	7422	03	6854
GK 200 K1 / K2, GK 300 / 400	0,60	BR4HS	3322	-	-	GXV 390 / 390 DA2 / 390 K1 / 390 K2 / 520 / 530	0,70	BPR5ES	7422	03	6854
GS 50 AC	0,60	B-4H	4110	-	-	GXV 610	0,70	BPR5ES	7422	03	6854
GS 65 / 65 AC, GS 80	0,60	BR6HS	3922	-	-	GXV 610 K1	0,70	ZGR5A	5839	-	-
GS 160	0,70	BPR6ES	7822	04	7678	GXV 620	0,70	BPR5ES	7422	03	6854
GS 160 A	0,60	BPR6ES	7822	04	7678	GXV 620 K1	0,70	ZGR5A	5839	-	-
GS 190	0,70	BPR6ES	7822	04	7678	GXV 630 / 660	0,70	ZFR5F	5165	-	-
GS 190 A	0,60	BPR6ES	7822	04	7678	GXV 670	0,70	ZGR5A	5839	-	-
GSV 160	0,70	BPR6ES	7822	04	7678	GXV 690	0,70	ZFR5F	5165	-	-
GSV 160 A	0,60	BPR6ES	7822	04	7678	H 5013	1,10	BPR6ES-11	4824	-	-
GSV 190	0,70	BPR5ES	7422	03	6854	HHT 255SLTA / 31S / 31TA, HHTUMK 25	0,80	C7HSA	4629	-	-
GSV 190 (Forte charge)	0,70	BPR6ES	7822	04	7678	HP 250 (-92)	0,60	BMR4A	5728	-	-
GSV 190 A	0,60	BPR6ES	7822	04	7678	HP 250 (93-)	0,60	BP6ES	7811	04	7678
GSV 190 LA	0,60	BPR5ES	7422	03	6854	HP 300	0,70	BPR2ES	2264	-	-
GT 50 / 65	0,60	B-4H	4110	-	-	HP 400	0,70	BPR4ES	7222	-	-
GV 35	0,60	BR6HS	3922	-	-	HP 500 H	0,70	BPR6ES	7822	04	7678
GV 100 / 100 K1	0,60	BMR4A	5728	-	-	HR 21(GV150) avec CDI, CDN	1,00	BPMR6A-10	1029	-	-
GV 100 K2	0,70	BPMR4A	6028	-	-	HR 21(GV150), CDN	0,60	BMR6A	7421	01	5478
GV 150	0,90	BMR6A	7421	01	5478	HS 522	0,70	BPR5ES	7422	03	6854
GV 150 (-2029059) CDN	0,60	BR4HS	3322	-	-	HS 1136 (GX340CDI)	1,10	BPR5ES-11	4424	-	-
GV 150 (2029060-) avec CDI	1,00	BPMR6A-10	1029	-	-	HT 3810 / 3810 K1 / 3813	0,60	BR4HS	3322	-	-
GV 150 A1D / 150 A2D	0,60	BMR6A	7421	01	5478	HTR 3009	0,70	BPR5ES	7422	03	6854
GV 150 CDI	0,90	BPMR6A	6726	08	5063	iGX 240 / 340	0,70	BPR6ES	7822	04	7678
GV 150 K1 (2029059-)	0,90	BMR6A	7421	01	5478	iGX 270	0,70	BPR5ES	7422	03	6854
GV 150 N1B / 150 N2B, GV 200	0,60	BMR6A	7421	01	5478	iGX 270 (Forte charge)	0,70	BPR6ES	7822	04	7678
GV 200 avec CDI	0,90	BPMR6A	6726	08	5063	iGX 390	0,70	BPR5ES	7422	03	6854
GV 400	0,60	BMR6A	7421	01	5478	iGX 390 (Forte charge)	0,70	BPR6ES	7822	04	7678
GV 400 CDI	0,90	BPMR6A	6726	08	5063	NBK 20 / 30	0,60	B-4H	4110	-	-
GV 400 K1	0,60	BM6A	5921	01	5478	PH 1800 (97-), PH 2600 (97-), PH 3800 (97-)	0,70	BPR6ES	7822	04	7678
GVC 135 / 160 / 190	0,70	BPR6ES	7822	04	7678	PH 5000 (97-), PH 6500 / 6500S (97-)	0,70	BPR5ES	7422	03	6854
GVC 520 / 530	0,70	BPR5ES	7422	03	6854	RT 500	1,10	BPR6ES-11	4824	-	-
GX 22	0,60	CR5HSB	6535	-	-	TH 40	0,70	BP6ES	7811	04	7678
GX 25 / 25 Digital Cdi	0,70	CMR5H	7599	-	-	TH 45	0,70	BP5ES	6511	03	6854
GX 25 T	0,60	CMR5H	7599	-	-	W 10 / 15	0,60	C6HSA	3228	-	-
GX 30 / 31 / 33	0,60	CR5HSB	6535	-	-	W 20 / 30	0,60	BR6HS	3922	-	-
GX 35	0,70	CMR5H	7599	-	-	W 40	0,70	BPR6ES	7822	04	7678
GXH 50	0,70	CR4HSB	4695	-	-	WA 10, WA 15 / 15 C	0,60	BMR4A	5728	-	-
GXH 50 (Forte charge)	0,60	CR5HSB	6535	-	-	WA 20 (G150) avec CDI, CDN	1,00	BPR4HS-10	5024	-	-
GX 100 STD / 100 TAMP / 100 U	0,60	CR5HSB	6535	-	-	WA 20 K1	0,60	BR4HS	3322	-	-
GX 110, GX 120 / 120 K1 / 120 T1, GX 140	0,70	BPR6ES	7822	04	7678	WA 20 X	0,80	BPR6ES	7822	04	7678
GX 160 / 160 H1 / 160 K1 / 160 K1 QPU / 160 T1	0,70	BPR6ES	7822	04	7678	WA 20 XK1	0,70	BR6ES	4922	-	-
GX 200	0,70	BPR5ES	7422	03	6854	WA 30 (G200) avec CDI, CDN	1,00	BPR4HS-10	5024	-	-
GX 200 (Forte charge)	0,70	BPR6ES	7822	04	7678	WA 30 X	0,80	BPR6ES	7822	04	7678
GX 200 QHQ4	0,80	BPR6ES	7822	04	7678	WAK 20 / 30	0,60	BR4HS	3322	-	-

Modèle

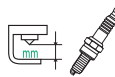

 N° STOCK BOÎTE
 N° BLISTER
 N° STOCK BLISTER

HONDA - Générateurs				
WB 10 / 15	0,80	BMR4A	5728	- -
WB 20 / 20 X / 20 XT / 30 XK1 / 30 XT	0,80	BPR6ES	7822	04 7678
WD 20 X / 30 X, WH 15 X / 15 XK1, WH 20 X	0,70	BPR6ES	7822	04 7678
WJR 2210 / 2215 / 2225	0,70	C5HSB	6452	- -
WL 20	0,60	C6HSA	3228	- -
WMP 20X	0,80	BPR6ES	7822	04 7678
WN 30, WP 20 / 20X, WP 30 / 30 X	0,70	BPR6ES	7822	04 7678
WT 20 (-88)	0,60	BR4HS	3322	- -
WT 20 (89)	1,10	BPR4HS-10	5024	- -
WT 20 XK1 / 20 XK2 / 20 XK3	0,70	BPR6ES	7822	04 7678
WT 30 (-88)	0,60	BR4HS	3322	- -
WT 30 (89)	1,10	BPR4HS-10	5024	- -
WT 30 X / 30 XK2 / 30 XK3, WT 40 X	0,70	BPR6ES	7822	04 7678
WX 10 / 15	0,70	CR5HSB	6535	- -

HONDA - Outils Divers

F 25 / 28	0,60	C6HSA	3228	- -
F 30 / 40	0,60	BR6HS	3922	- -
F 42	0,60	B6HS	4510	- -
F 42 K1	0,60	BR6HS	3922	- -
F 50 / 60	0,60	D6HA	6512	- -
F 80	0,60	B5ES	6410	- -
F 110	0,60	BMR4A	5728	- -
F 200	0,60	BPMR4A	6028	- -
F 200 A / 200 C	0,60	BMR4A	5728	- -
F 200 D / 200 F / 200 G / 200 I / 200 S	1,00	BPMR4A-10	6328	- -
F 210	0,60	BMR4A	5728	- -
F 210 K1	0,70	BPR5ES	7422	03 6854
F 220	0,60	CR4HSB	4695	- -
F 250 D / 250 F	1,00	BPMR4A-10	6328	- -
F 260	0,60	BMR4A	5728	- -
F 300 Mot. G150	0,60	BR4HS	3322	- -
F 310	0,70	BPR5ES	7422	03 6854
F 310 KZ	0,70	BP5ES	6511	03 6854
F 320	0,70	BPR5ES	7422	03 6854
F 325	0,60	BPR6ES	7822	04 7678
F 340 / 360 / 380	0,70	BPR5ES	7422	03 6854
F 400	0,70	BR6HS	3922	- -
F 400 A2 / 400 D1 / 400 D2 / 400 F1	0,60	BR4HS	3322	- -
F 400 F2	1,00	BPR4HS-10	5024	- -
F 400 G, F 400 Mot. G150	0,60	BR4HS	3322	- -
F 400 Mot. G150 avec CDI, CDN	1,00	BPR4HS-10	5024	- -
F 400 Mot. G35	0,60	BR6HS	3922	- -
F 400 SP / 400 V	0,60	BR4HS	3322	- -
F 401 / 401 A2 / 401 AD / 401 K1 / 401 K2	0,70	BPR5ES	7422	03 6854
F 405	0,60	BR4HS	3322	- -
F 410	0,70	BPR5ES	7422	03 6854
F 420	0,70	BPR5ES	7422	03 6854
F 450 D / 450 F	1,00	BPR4HS-10	5024	- -
F 450 G	0,60	BR4HS	3322	- -
F 450 SP	1,00	BPR4HS-10	5024	- -
F 460	0,70	BPR5ES	7422	03 6854
F 500 / 500 A1 / 500 A2	0,60	BR4HS	3322	- -
F 501 / 501 A1 / 501 A2 / 501 K1 / 501 K2, F 506	0,70	BPR5ES	7422	03 6854
F 510 K2	0,70	BP5ES	6511	03 6854
F 520 / 560	0,70	BPR5ES	7422	03 6854
F 600	0,60	BR4HS	3322	- -
F 600 F2	1,00	BPR4HS-10	5024	- -
F 600 G / 600 G2 / 600 P / 600 SP / 600 Y	0,60	BR4HS	3322	- -
F 610	0,70	BPR5ES	7422	03 6854
F 650	0,60	BR6HS	3922	- -
F 660	0,70	BPR5ES	7422	03 6854
F 660 K	0,70	BP5ES	6511	03 6854
F 700	0,60	BR6HS	3922	- -
F 720	0,70	BPR5ES	7422	03 6854
F 800	0,60	BR4HS	3322	- -
F 800 avec CDI, CDN	1,00	BPR4HS-10	5024	- -
F 800 D / 800 DW	0,60	BR4HS	3322	- -
F 800 F	1,00	BPR4HS-10	5024	- -
F 800 G	0,60	BR4HS	3322	- -
F 800 S1 / 800 S2	1,00	BPR4HS-10	5024	- -
F 800 Y	0,60	BR4HS	3322	- -
F 810	0,70	BPR5ES	7422	03 6854
F 860	0,70	BP5ES	6511	03 6854

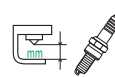
Modèle



 N° STOCK BOÎTE
 N° BLISTER
 N° STOCK BLISTER

F 950	0,60	BR4HS	3322	- -
F 950 K1	0,60	B-4H	4110	- -
F 950 P	0,60	BR4HS	3322	- -
F 1150	1,10	BP5ES-11	7311	- -
FC 600	0,70	BPR5ES	7422	03 6854
FF 500	0,70	BPR6ES	7822	04 7678
FG 110	0,60	CMR5H	7599	- -
FG 200 / 201	0,60	CR4HSB	4695	- -
FG 220	0,50	CR4HSB	4695	- -
FG 314 / 315 / 400 / 500	0,70	BPR6ES	7822	04 7678
FR 315	0,70	BP4ES	6928	- -
FR 500	0,60	BR4HS	3322	- -
FR 600 / 650	0,70	BPR5ES	7422	03 6854
FR 700	0,60	BR4HS	3322	- -
FR 750 / 800	0,70	BPR5ES	7422	03 6854
FRC 800	0,70	BPR6ES	7822	04 7678
FS 28	0,60	C6HSA	3228	- -
FS 50	0,60	BR6HS	3922	- -
FT 315 / 325	1,00	BPR4HS-10	5024	- -
FT 65	0,60	B-4H	4110	- -
FU 750 Lucky	0,60	BPR6ES	7822	04 7678
FX 25	0,60	BR6HS	3922	- -
H 5518	0,60	BPR5ES	7422	03 6854
HHB 25	0,70	CMR5H	7599	- -
HHBH 25 / 25 D-60 / 25 D-75 / 25 S-75	0,60	CMR5H	7599	- -
HSM 1180 i / 1390 i	0,70	BPR6ES	7822	04 7678
HSM 1590 i	0,70	BKR6E	6962	- -
HSS 1380 i	0,60	BPR5ES	7422	03 6854
WDP 30 X	0,70	BPR6ES	7822	04 7678

HONDA - Tondeuses

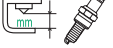
H 1011H / S, H 2013S, H 3001 / H	0,70	BPR5ES	7422	03 6854
H 3009 / 3011 / 3011 H / 3013H / 4013	0,70	BPR5ES	7422	03 6854
H 4514	0,70	BPR4ES	7222	- -
H 4518	1,10	BPR5ES-11	4424	- -
H 4518 H	1,00	BPR5ES-11	4424	- -
H 5013 (A2 A/B/C) Mot. GX390 13hp	1,10	BPR6ES-11	4824	- -
H 5013 (A2D, A4D) Mot. GX390K1 13hp	0,70	BPR6ES	7822	04 7678
H 5013 (A4 A/B/C) Mot. GX390 13hp	1,10	BPR6ES-11	4824	- -
H 5013 (AC2 A/B) / (AC4 A/B) Mot. GX390K1 13hp	0,70	BPR6ES	7822	04 7678
H 5518 Mot. GX640 20 hp	1,00	BPR5ES-11	4424	- -
HC 16	0,60	BMR4A	5728	- -
HC 20 / 26	0,80	BPR6ES	7822	04 7678
HF 1211 / H / S, HF 2114 S / H	0,70	BPR5ES	7422	03 6854
HF 2200 HL, HF 2200 S / H	0,80	ZGR5A	5839	- -
HF 2213 / H / S, HF 2216 H / S / K1	0,70	BPR5ES	7422	03 6854
HF 2218 HL / SL / SE, HF 2220 SL / K1	0,70	BPR5ES	7422	03 6854
HF 2315 HM / SB / 2415 SB	0,70	BPR5ES	7422	03 6854
HF 2417 HT / HAT / HM	0,70	BPR5ES	7422	03 6854
HF 2620 HAT	0,60	CR5HSB	6535	- -
HF 2620 HT	0,70	BPR5ES	7422	03 6854
HR 17 - Mot. GV100 2.2 hp	0,80	BM4A	5628	- -
HR 21 - Mot. GV150 3.5 hp (2029059->)	0,70	BPMR6A	6726	08 5063
HR 21 - Mot. GV150K1 3.5 hp (3040714->)	0,70	BPMR6A	6726	08 5063
HR 21 Allumage Mag.	0,80	BMR6A	7421	01 5478
HR 21 Allumage Standard (->2029058)	0,80	BP5HS	4111	- -
HR 21 Allumage Standard (2029059->)	0,80	BMR6A	7421	01 5478
HR 21 CDI - Mot. GV150K1 3.5hp (3040714->)	1,00	BPMR6A-10	1029	- -
HR 21 CDI (jusqu'à 2029058)	0,80	B5HS	4210	- -
HR 21 K2	1,00	BPMR6A-10	1029	- -
HR 21-5 - Mot. GV200 4 hp (1026849->)	0,70	BPMR6A	6726	08 5063
HR 21-5 CDI - Mot. GV200 4 hp (1026849->)	1,00	BPMR6A-10	1029	- -
HR 173 - Mot. GV100K1 2.5 hp	0,70	BM4A	5628	- -
HR 194	0,70	BP5ES	6511	03 6854
HR 194 / 195 - Mot. GXV120 4 hp	0,70	BPR5ES	7422	03 6854
HR 214 - Mot. GXV120 4 hp	0,80	BPR5ES	7422	03 6854
HR 215 / K1 - Mot. GXV140 5 hp	0,80	BPR5ES	7422	03 6854
HR 215 K1HMA / K1HXA / K1SXA	0,80	BPR6ES	7822	04 7678
HR 21-5 W - Mot. GV200 4 hp (de 1026849)	1,00	BPMR6A-10	1029	- -
HR 216 / 2160 - Mot. GXV160 5.5 hp, HR 2150	0,80	BPR5ES	7422	03 6854
HR 21A - Mot. GV150K1 3.5 hp (3040715->)	0,70	BPMR6A	6726	08 5063
HR 21A CDI GV150K1 3.5hp (3040715->)	1,00	BPMR6A-10	1029	- -
HR 21AW - Mot. GV150K1 3.5hp (3040715->)	1,00	BPMR6A-10	1029	- -
HR 21W Mot. GV150 3.5 hp (de 3040715)	1,00	BPMR6A-10	1029	- -
HR 521	0,70	BR4HS	3322	- -
HR 1950 S / SM / SX	0,70	BPR5ES	7422	03 6854

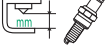
Modèle		N°		
		STOCK	BLISTER	STOCK
		BOÎTE	BLISTER	BLISTER
HRA 21	0,60	BMR6A	7421	01 5478
HRA 173	0,60	BMR4A	5728	- -
HRA 214 - Mot. GXV120 4 hp	0,80	BPR5ES	7422	03 6854
HRA 215 - Mot. GXV140 5 hp	0,80	BPR6ES	7822	04 7678
HRA 216 / 2160 - Mot. GXV160 5.5 hp	0,80	BPR5ES	7422	03 6854
HRA 219 / 536 HX	0,80	BPR5ES	7422	03 6854
HRA 2150	0,70	BPR6ES	7822	04 7678
HRB 215 / HXA / PXA - Mot. GXV140 5 hp	0,80	BPR6ES	7822	04 7678
HRB 215 K1 / K2 / K3 / K4 - Mot. GXV140 5hp	0,80	BPR5ES	7422	03 6854
HRB 215 SDA / SXA - Mot. GXV140 5 hp	0,80	BPR6ES	7822	04 7678
HRB 216 - Mot. GXV160 / A 5.5 hp	0,80	BPR5ES	7422	03 6854
HRB 216 TDA	0,70	BPR6ES	7822	04 7678
HRB 217 - Mot. GCV 6.5 hp	0,80	BPR6ES	7822	04 7678
HRB 217 HXA / TDA	0,80	BPR5ES	7422	03 6854
HRB 423 P / PD / S / SD / SX	0,70	BMR4A	5728	- -
HRB 425C / PD / SD / PX / SX / QX	0,80	BPR6ES	7822	04 7678
HRB 475 HM / HX / P / PD / S / SD / SM / SX	0,80	BPR5ES	7422	03 6854
HRB 475 K0 / K1 / K2 / K3, HRB 475C PD / SD	0,80	BPR5ES	7422	03 6854
HRB 476C HX / PX / QX / SX / TX / PD / SD	0,80	BPR6ES	7822	04 7678
HRB 535 SX / K0 / K1 / K2 / K3	0,80	BPR5ES	7422	03 6854
HRB 536 C / C1 / C2, HRB 536C SX / TX	0,80	BPR6ES	7822	04 7678
HRC 215 / K1 - Mot. GXV140 5 hp	0,80	BPR5ES	7422	03 6854
HRC 215K1 PDA / SDA	0,80	BPR6ES	7822	04 7678
HRC 216 / K1 / K2 - Mot. GXV160 5.5 hp	0,80	BPR5ES	7422	03 6854
HRC 216 HXA / 216 PDA / 7013	0,70	BPR5ES	7422	03 6854
HRC 216K1HXA / SXA	0,80	BPR5ES	7422	03 6854
HRC 216K2 - Mot. GSV160A1	0,80	BPR6ES	7822	04 7678
HRD 535 HX / QX / SM / SX / TM	0,80	BPR5ES	7422	03 6854
HRD 535 K0	0,80	BPR6ES	7822	04 7678
HRD 535 K1 / K2, HRD 536 C1 / C2	0,80	BPR5ES	7422	03 6854
HRD 536 HM / HX / HXE	0,70	BPR5ES	7422	03 6854
HRD 536 K0 / K1 / K2 / K3, HRD 536 QX	0,80	BPR5ES	7422	03 6854
HRD 536C HX / SX / TX	0,80	BPR6ES	7822	04 7678
HRF 464, 465 / PD / SD / P / S	0,80	BPR5ES	7422	03 6854
HRG 413 PD / SD	0,70	BMR4A	5728	- -
HRG 415 C / C1 / C2, HRG 465 C1/C2	0,80	BPR6ES	7822	04 7678
HRG 465 PD / SD	0,80	BPR5ES	7422	03 6854
HRG 465C PD / SD	0,80	BPR6ES	7822	04 7678
HRG 536 C / C1 / C2 / C3	0,80	BPR5ES	7422	03 6854
HRG 536C SD	0,80	BPR6ES	7822	04 7678
HRH 536 HX	0,70	BPR6ES	7822	04 7678
HRH 536 QX, HRM 195 - Mot. GXV140 5 hp	0,80	BPR5ES	7422	03 6854
HRM 21	0,80	B5HS	4210	- -
HRM 195 PA, HRM 215 / HXA / K1 / K2	0,80	BPR6ES	7822	04 7678
HRM 215 / K1 / K2 / K3 / K4 - Mot. GXV140 5hp	0,80	BPR5ES	7422	03 6854
HRM 215 PXA / SXA / DPA	0,80	BPR6ES	7822	04 7678
HRM 535 SX	0,80	BPR5ES	7422	03 6854
HRM 536C / SX / TX	0,80	BPR6ES	7822	04 7678
HRR 216 - Mot. GCV160 5.5hp	0,80	BPR5ES	7422	03 6854
HRR 216 K2 PDA / SDA	0,80	BPR5ES	7422	03 6854
HRR 216 PDA / 216 PKA / 216 VKA / 216 VXA	0,70	BPR5ES	7422	03 6854
HRR 216 S3DA / SDA	0,80	BPR6ES	7822	04 7678
HRR 216 VYA	0,70	BPR5ES	7422	03 6854
HRR 216K1 / K2 / K3 / T - Mot. GCV160A	0,80	BPR5ES	7422	03 6854
HRS 21 - Mot. GXV110 3.5hp	0,80	BR4HS	3322	- -
HRS 21 CDI	0,80	B6HS	4510	- -
HRS 216 - Mot. GCV160 5.5hp	0,80	BPR5ES	7422	03 6854
HRS 216 K1 / K2 - Mot. GCV160A 5.5hp	0,80	BPR5ES	7422	03 6854
HRS 216 K2 PDA / SDA	0,80	BPR5ES	7422	03 6854
HRS 535C SD	0,80	BPR6ES	7822	04 7678
HRT 216 - Mot. GCV160A 5.5hp	0,80	BPR5ES	7422	03 6854
HRT 216 K1 / K2 - Mot. GCV160A 5.5hp	0,80	BPR5ES	7422	03 6854
HRT 216 K2 TDA	0,80	BPR5ES	7422	03 6854
HRT 216 S3DA / SDA	0,80	BPR6ES	7822	04 7678
HRX 217 - Mot. GCV190 6.5hp	0,80	BPR6ES	7822	04 7678
HRX 217 HMA / 217 HYA	0,70	BPR5ES	7422	03 6854
HRX 217 HXA / TDA	0,80	BPR5ES	7422	03 6854
HRX 217 HZA / VKA	0,70	BPR5ES	7422	03 6854
HRX 426 / 476 (GCV160) / 537 (GCV190)	0,80	BPR6ES	7822	04 7678
HRX 426C SX / PD / PX / QX / SD	0,80	BPR6ES	7822	04 7678
HRX 476C SX / PX / QX / SD / HX	0,80	BPR6ES	7822	04 7678
HRX 537C HM / HX / TD / VYE	0,80	BPR6ES	7822	04 7678
HRZ 216 - Mot. GCV160A 5.5hp	0,80	BPR5ES	7422	03 6854
HRZ 216 TDA	0,80	BPR5ES	7422	03 6854
HRZ 536C TD	0,80	BPR6ES	7822	04 7678
HS 622 TA, 1132 TA / TAS	0,80	BPR5ES	7422	03 6854
HT 3810 Mot. G400/K1	0,70	BR4HS	3322	- -

Modèle		N°		
		STOCK	BLISTER	STOCK
		BOÎTE	BLISTER	BLISTER
HT 3813	0,70	BPR4HS	7823	- -
HT 4518H	1,10	BPR5ES-11	4424	- -
HTR 3009 Mot. GXV270 / 3811	0,80	BPR5ES	7422	03 6854
IZY Mot. GCV135 / GCV160	0,80	BPR6ES	7822	04 7678
RT5000 (A) Mot. GX340 11 hp	1,10	BPR6ES-11	4824	- -

HOUGH - Manutention

P40	0,60	AB-6	2910	- -
T120F, T150	0,60	B6S	3510	09 6048
T180, T225	0,60	BR6S	3522	09 6048
T30A, T50A	0,60	AB-6	2910	- -

HUDSON - Tronçonneuses

Oscar 18 / 28	0,80	BR2-LM	5798	06 4740
---------------	------	--------	------	---------

HUFFMAN - Tondeuses

Tous modèles	0,70	BR2-LM	5798	06 4740
--------------	------	--------	------	---------

HUFFY - Tondeuses

Tous modèles	0,70	BR2-LM	5798	06 4740
--------------	------	--------	------	---------

HURRICANE - Tondeuses

Tous modèles	0,70	BR2-LM	5798	06 4740
--------------	------	--------	------	---------

HUSQVARNA - Débroussailleuses

16 H	0,50	BMR7A	4226	10 6793
16 R	0,60	BM6A	5921	01 5478
18 H - Mot. 18 cc	0,80	BPM6A	7021	08 5063
18 R / RL	0,60	BMR6A	7421	01 5478
21 LCN Mot. 21cc 6 hp	0,80	BPM6A	7021	08 5063
22 R / 22 RL	0,60	BMR6A	7421	01 5478
24 H	0,50	BMR7A	4226	10 6793
24 R	0,60	BMR6A	7421	01 5478
25 GT	0,50	BM4A	5628	- -
25 H - Mot. 26cc	0,60	BM6A	5921	01 5478
25 RL	0,60	BMR6A	7421	01 5478
26 L / LC	0,50	BPMR6A	6726	08 5063
26 R / RJ, 265 RX Mot. 65cc 4 hp	0,70	BPMR7A	4626	02 5959
27 GTS	0,50	BM4A	5628	- -
32 L / LC Mot. 32 cc 9 hp, 32 R, 36 R / RG, 39 R	0,50	BPMR6A	6726	08 5063
46 MR	0,50	BR2-LM	5798	06 4740
65 R, HVT 1500, HVT1200 Mot. 50cc 2 hp	0,70	BPMR7A	4626	02 5959
123 C	0,70	BPMR7A	4626	02 5959
125 R / RL / RD / RB / L / LD	0,70	BPM6Y	4562	- -
125 RJ	0,60	BPMR6Y	5256	- -
132 HBV	0,50	BMR7A	4226	10 6793
132 R / RB / RD / L / LD	0,70	BPM6Y	4562	- -
140 R	0,70	BPMR7A	4626	02 5959
165 R	0,70	BPMR7A	4626	02 5959
165 RX / 244 GX / 268 K	0,50	BPMR6A	6726	08 5063
223 L, 225 B / H - Mot. 25.4 cc 1.2 hp	0,70	BPMR7A	4626	02 5959
225 DR / RT, 232 LR	0,50	BMR7A	4226	10 6793
225 E Mot. 25cc 1.2 hp, 225 H60 / H75	0,70	BPMR7A	4626	02 5959
225 HP, 225 L / LD Mot. 25cc 1.2 hp	0,70	BPMR7A	4626	02 5959
225 Lite, 225 R / RD / RJ Mot. 25cc 1.2 hp	0,70	BPMR7A	4626	02 5959
226 HD60S / HD75S / HS75S / HS99S Mot. 1.15hp	0,70	CMR7H	3066	- -
232 CAT, 232 L CAT, 232 L Mot. 31cc 1.5 hp	0,70	BPMR7A	4626	02 5959
232 R CAT	0,50	BPMR7A	4626	02 5959
232 R Mot. 31cc 1.5 hp, 235 CAT, 235 P	0,70	BPMR7A	4626	02 5959
235 R CAT	0,50	BPMR7A	4626	02 5959
235 R Mot. 36cc 1.8 hp	0,70	BPMR7A	4626	02 5959
240 R Mot. 40cc 2.4 hp, 240 RBD Mot. 36cc 1.8 hp	0,50	BPMR7A	4626	02 5959
244 R / RX / RXG	0,70	BPMR7A	4626	02 5959
245 R / RX Mot. 44cc 2.7 hp	0,50	BPMR7A	4626	02 5959
250 PS, 250 R Mot. 48.7cc, 250 RX	0,70	BPMR7A	4626	02 5959
323 C / E / L / R Mot. 24.5cc 1.5 hp	0,70	BPMR7A	4626	02 5959
324 L Mot. 24.5cc 1.5 hp, 325 C	0,70	BPMR7A	4626	02 5959
325 CX Mot. 24.5cc 1.5 hp, 325 EX	0,70	BPMR7A	4626	02 5959
325 HDA55X Mot. 1.2 hp	0,50	BPMR7A	4626	02 5959
325 HS75x, 325 L / LX / RJX / RX	0,70	BPMR7A	4626	02 5959
326 75x / A55X / E-Tech II	0,70	BPMR7A	4626	02 5959
326 EX Mot. 24.5cc 1.5 hp, 326 HD60X Mot. 1.2 hp	0,70	BPMR7A	4626	02 5959
326 HD75X Mot. 1.2 hp	0,50	BPMR7A	4626	02 5959

Modèle

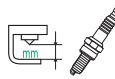
 N° STOCK BOÎTE
 N° BLISTER
 N° BLISTER

HUSQVARNA - Débroussailluses				
326 HDA, 326 HE3X / HE4X Mot. 1.2 hp	0,70	BPMR7A	4626	02 5959
326 HS75X Mot. 1.2 hp, 326 HS99X Mot. 1.2 hp	0,50	BPMR7A	4626	02 5959
326 L / LD Mot. 24.5cc 1.5 hp, 326 LDX	0,70	BPMR7A	4626	02 5959
326 LX Mot. 24.5cc 1.5 hp	0,50	BPMR7A	4626	02 5959
326 RJX, 326 RX Mot. 24.5cc 1.5 hp, 326 SX	0,70	BPMR7A	4626	02 5959
335 R	0,60	CMR6A	1223	- -
HVT40 - Mot. Tecumseh TC300 50cc 2 hp	0,70	BPMR7A	4626	02 5959
HVT52, HTV1200, HTV1500, HTV2000	0,80	BR4-LM	4133	05 4358
Mondo / Max / Mega	0,70	BPMR7A	4626	02 5959
Mondo Max, Mondo Mega Mot. 24cc. 8 hp	0,60	BPMR7A	4626	02 5959
Mondo Mot. 21cc. 7 hp	0,60	BPMR7A	4626	02 5959

HUSQVARNA - Outils Divers

ST 268 EP	0,70	BKR5ES	2460	07 4803
-----------	------	--------	------	---------

HUSQVARNA - Tondeuses

46 ST / SR - Mot. B&S 3.5PS	0,50	BR4-LM	4133	05 4358
48 SEK / 53 SEK	0,70	BPR6ES	7822	04 7678
50 DK Mot. B&S 3.75hp	0,70	BR2-LM	5798	06 4740
51 / D Mot. B&S 4.5 hp, 51 MD Mot. B&S 5.5 hp	0,70	BR2-LM	5798	06 4740
51 MDT, 56 HST / HT	0,70	BR6S	3522	09 6048
55B21HV Mot. Honda OHC 5.5 hp	0,70	BPR6ES	7822	04 7678
55C21HV Mot. Honda 5.5 hp	0,70	BPR6ES	7822	04 7678
55R21HV Mot. Honda OHC 5.5 hp	0,70	BPR6ES	7822	04 7678
56 DH / DHS / H / HS / SF / SF - Mot. B&S 5.5hp	0,70	BR2-LM	5798	06 4740
56 HST, 56 HT	0,60	B6S	3510	09 6048
400 B, 450 P, 453 D - Mot. B&S 3.5PS	0,50	BR4-LM	4133	05 4358
425 S	0,60	BPMR6A	6726	08 5063
485 K / SK / EK / 535 EK	0,60	BPR6ES	7822	04 7678
535 Mot. B&S Master Garden	0,60	BR2-LM	5798	06 4740
543S, 4 PS - Mot. B&S	0,50	BR4-LM	4133	05 4358
560 H / HS Mot. B&S Intek OHV 6 hp	0,70	BKR5ES	2460	07 4803
560 HST / HT Mot. Tecumseh OHV 6 hp	0,70	B6ES	7310	- -
560 SR Mot. B&S Intek OHV 6 hp	0,70	BKR5ES	2460	07 4803
580 BBC / R / RS / RSE / RSW	0,80	BKR5E	7938	07 4803
600 C, 6521RS, 6522 CH/SH	0,80	BKR5E	7938	07 4803
820-8, 970-12 R / S, 1200-14	0,70	BM6A	5921	01 5478
970-12S Mot. B&S 12.5 hp, 980H15-B	0,80	B2-LM	1147	06 4740
1200-14	0,70	BM6A	5921	01 5478
5521 CM / CHV / RS - Mot. Honda 5.5 hp	0,70	BPR6ES	7822	04 7678
5521 Series Mot. Honda GXV140 5 hp	0,70	BPR5ES	7422	03 6854
6020 MD, 6022 CH / SH	0,70	BR2-LM	5798	06 4740
7021 CH1 / CM - Mot. B&S 7 hp	0,70	BR2-LM	5798	06 4740
CZ3815 Mot. B&S 15 hp	0,70	BKR5ES	2460	07 4803
CZ4217 / 4817 - Mot. Kohler CV490 17 hp	0,70	BKR5ES	2460	07 4803
CZ4815 Mot. Kawa. V-Twin FH430V 15hp	0,90	BCPR6ES	2330	- -
EZ4216 Mot. Honda Twin OHV 16hp	0,80	BPR5ES	7422	03 6854
EZ4217 Mot. Kawasaki V-Twin 17 hp	0,70	BPMR6A	6726	08 5063
EZ5221 Mot. Kawasaki V-Twin 21 hp	0,60	BPR4ES	7222	- -
GT200	0,80	BCPR5ES	6130	07 4803
GTH2248XP Mot. Kawa. V-Twin OHV 22hp	0,60	BMR6A	7421	01 5478
GTH2250 / 2550	0,80	BCPR5ES	6130	07 4803
GTH2254XP Mot. Kawa. V-Twin OHV 22hp	0,60	BMR6A	7421	01 5478
GTH2548 / XP Mot. Kawa. V-Twin OHV 25hp	0,70	BCPR6ES	2330	- -
GTH2554 Mot. Kawa. V-Twin OHV 25hp	0,90	BCPR6ES	2330	- -
GTH2554XP Mot. Kawa. V-Twin OHV 25hp	0,70	BCPR6ES	2330	- -
GTH26K54T Mot. Kohler EFI 26 hp	0,70	BKR5ES	2460	07 4803
HVT40, iZ4217 / iZ4817 - Mot. Kawasaki 17 hp	0,70	BPMR6A	6726	08 5063
iZ4218 / 4818 - Mot. Kawa. V-Twin 18 hp	0,90	BCPR6ES	2330	- -
iZ4821 / 5221 - Mot. Kawa. V-Twin 21 hp	0,60	BPR4ES	7222	- -
iZ4919 Mot. Kawasaki FH601V 19 hp	0,60	BPR4ES	7222	- -
iZ5223 Mot. Kawasaki V-Twin 23 hp	0,60	BPR4ES	7222	- -
iZ5223 Mot. Kohler V-Twin 23 hp	0,70	BKR5ES	2460	07 4803
iZ5225TXP Mot. Kohler V-Twin 25 hp	0,70	BKR5ES	2460	07 4803
iZ6123 Mot. Kawasaki V-Twin 23 hp	0,60	BPR4ES	7222	- -
iZ6125 Mot. Kohler V-Twin 25 hp	0,70	BKR5ES	2460	07 4803
LR110 Mot. B&S 11 hp	0,80	B2-LM	1147	06 4740
LR120 / 121 / 122 - Mot. B&S 12 hp	0,80	B2-LM	1147	06 4740
LT100 / 120 / 960-12 / 4140 G-H	0,70	BM6A	5921	01 5478
LT1538 Mot. Kohler 15hp	1,00	BKR5ES-11	2382	- -
LTH120 Mot. B&S 12 hp	0,80	B2-LM	1147	06 4740
LTH18542 Mot. B&S 18.5hp	0,70	BR2-LM	5798	06 4740
LTH2042 Mot. Kohler Courage 20 hp	0,70	BKR5ES	2460	07 4803

Modèle

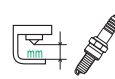
 N° STOCK BOÎTE
 N° BLISTER
 N° BLISTER

LZ5225T Mot. Kawasaki V-Twin 25hp	0,60	BPR2ES	2264	- -
LZ5227TXP Mot. Kohler V-Twin 27 hp	0,70	BKR5ES	2460	07 4803
LZ6123TL Mot. Kohler (Ref. Liqu.) 23 hp	0,70	BKR5ES	2460	07 4803
LZ6125T Mot. Kawasaki V-Twin 25hp	0,60	BPR2ES	2264	- -
LZ6127T Mot. Kohler V-Twin 27 hp	0,70	BKR5ES	2460	07 4803
LZ7227 T Mot. Kohler V-Twin 27 hp	0,70	BKR5ES	2460	07 4803
M48 Pro / M53 S Pro	0,70	BPR6ES	7822	04 7678
Master Pro	0,70	BR2-LM	5798	06 4740
Master Pro2, Pro4	0,70	BM6A	5921	01 5478
MK500, MK500 Auto	0,60	BM6A	5921	01 5478
Mot. B&S 12.5 / 13hp	0,70	BR2-LM	5798	06 4740
Mot. B&S 22hp	0,70	BKR5ES	2460	07 4803
Mot. B&S 8.5 / 10 / 11 / 12hp	0,70	BR2-LM	5798	06 4740
Mot. B&S Intek 15.5 / 17 / 20 / 25 hp	0,80	BCPR5ES	6130	07 4803
Mot. B&S Intek 24 hp	0,70	BKR5ES	2460	07 4803
Mot. B&S OHV 14.5hp	0,80	BCPR5ES	6130	07 4803
Mot. B&S Vanguard 13 / 16hp	0,80	BCPR5ES	6130	07 4803
Mot. B&S Vanguard V-Twin 18 / 20 hp	0,80	BCPR5ES	6130	07 4803
Mot. Kawasaki (ref. liquide) 27 hp	0,80	BP5ES	6511	03 6854
Mot. Kawasaki 12.5 hp	0,70	BM6A	5921	01 5478
Mot. Kawasaki 15 hp / OHV YTH1542XP	0,80	BP5ES	6511	03 6854
Mot. Kawasaki OHV 14 / 18 / 21 / 23 / 25 hp	0,80	BP5ES	6511	03 6854
Mot. Kawasaki OHV V-Twin 17 hp	0,80	BPM6A	7021	08 5063
Mot. Kawasaki S OHV	0,60	BP5ES	6511	03 6854
Mot. Kohler (Twin) 18 / 20 / 21hp	0,60	BPR4FS	1127	- -
Mot. Kohler (V-Twin) 18 / 20 / 22 / 25 hp	0,80	BCPR5ES	6130	07 4803
Mot. Kohler 20 hp	0,70	BKR5ES	2460	07 4803
Mot. Kohler 28 hp	0,80	BCPR5ES	6130	07 4803
Mot. Kohler AEGIS (ref.liquide) 23 hp	0,80	BCPR5ES	6130	07 4803
Mot. Kohler OHV 12.5 / 13 / 14 / 15 hp	0,80	BCPR5ES	6130	07 4803
Mot. Kohler V-Twin EFI 26 hp	0,80	BCPR5ES	6130	07 4803
Mot. Tecumseh 2 & 3.5 hp	0,50	BR4-LM	4133	05 4358
Mot. Tecumseh 6 hp	0,70	BR6S	3522	09 6048
Pro 15	0,80	BPM6A	7021	08 5063
Pro 15-V2 Mot. Kawasaki OHV 15 hp	0,60	BCPR6ES	2330	- -
ProFlex 21	0,80	B2-LM	1147	06 4740
Rider 1000-14, 1200-18	0,70	BPR5ES	7422	03 6854
Rider 1200-14	0,70	BM6A	5921	01 5478
Rider 14 Pro	0,80	BCPR5ES	6130	07 4803
Rider 155 Mot. Kohler Comm.OHV 15hp	1,00	BKR5ES-11	2382	- -
Rider 650	0,60	B4-LM	3410	05 4358
Rider 850-8, 850-12, 970-12 R/S	0,70	BM6A	5921	01 5478
Rider YTH 1120-14	0,70	BPR5ES	7422	03 6854
Royal 42, 46, 48 / S / SE, 425	0,60	BMR6A	7421	01 5478
Royal 43 / S / SE	0,60	BR2-LM	5798	06 4740
Royal 48 / 53S - 3.75 / 4 / 4.5 / 5 / 5.5 / 6 / 7 hp	0,70	BR2-LM	5798	06 4740
Royal 48 / 53S - Mot. B&S Intek OHV 6 / 6.5 hp	0,80	BKR5E	7938	07 4803
Royal 48 / 53S - Mot. Honda GCV160 5.5 hp	0,80	BPR5ES	7422	03 6854
Royal 48 / 53S - Mot. Honda OHV 5 hp	0,80	BPR6ES	7822	04 7678
Royal 48 / 53S - Mot. Kawasaki 25 hp	0,80	BPR5ES	7422	03 6854
Royal 48 / 53S - Mot. Kawasaki OHV	0,80	BPR5ES	7422	03 6854
Royal 48 / 53S - Mot. Tecumseh 2 / 3.5 hp	0,70	BR4-LM	4133	05 4358
Royal 48 / 53S - Mot. Tecumseh 6 hp	0,70	BR6S	3522	09 6048
Royal 48 / 53S - Mot. Tecumseh OHV 6 hp	0,80	BR7ES	5122	- -
Royal 48 / 53S Mot. Kohler 23 hp	0,70	B-6L	3212	- -
Royal 48 / 53S Mot. Kohler 27 hp	0,80	BKR5E	7938	07 4803
Royal 48 Mot. B&S 4 hp	0,80	B2-LM	1147	06 4740
Royal 48 SEK / SK, 53 SEK, 535 / E / EK	0,60	BPR6ES	7822	04 7678
Royal 820-8	0,70	BM6A	5921	01 5478
Royal Jet 50R	0,60	BR2-LM	5798	06 4740
T250, T300, T520, T560	0,60	BMR6A	7421	01 5478
TYH2148 Mot. B&S 21hp	0,70	BKR5ES	2460	07 4803
W21 Series Mot. Honda 5.5hp & Kawasaki 6hp	0,70	BPR5ES	7422	03 6854
W3213 / 3613 - Mot. Kohler CV13 13 hp	1,10	BKR5ES-11	2382	- -
W3613ETS Mot. Kawa. V-2 FH381V 13hp	0,60	BCPR6ES	2330	- -
W4815ETS Mot. Kawa. V-2 FH430V 15hp	0,60	BCPR6ES	2330	- -
WHF4215ETS Mot. Kawa. V-2 FH430V 15hp	0,60	BCPR6ES	2330	- -
WHF4817ETS Mot. Kawa. V-2 FH500V 17hp	0,60	BCPR6ES	2330	- -
WHF4818ETS Mot. Kawa. V-2 FH531V 18hp	0,60	BCPR6ES	2330	- -
WHF5218ETS Mot. Kawa. V-2 FH531V 18hp	0,60	BCPR6ES	2330	- -
WHT3615 / 4817 - Mot. Kawasaki 17 hp	0,60	BCPR6ES	2330	- -
YTH1120-14	0,70	BPR5ES	7422	03 6854
YTH1342 XP Mot. Kawa.V-2 OHV 13 hp	0,60	BCPR6ES	2330	- -
YTH150 - Mot. Kohler Command 15 hp	1,00	BKR5ES-11	2382	- -
YTH1542 / 1746 / 2046 / 2048	0,80	BCPR5ES	6130	07 4803
YTH1542 XP / XPT Mot. Kawa. V-2 OHV 15 hp	0,60	BCPR6ES	2330	- -
YTH155 Mot. B&S OHV 15.5 hp	0,70	BCPR5ES	6130	07 4803

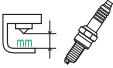
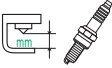
Modèle		N°			Modèle		N°			
		STOCK	BLISTER	BOÎTE			STOCK	BLISTER	BOÎTE	
YTH160	0,80	BCPR5ES	6130	07	4803	0,50	BPMR6A	6726	08	5063
YTH1848XPT Mot. Kawa. V-Twin OHV 18hp	0,60	BMR6A	7421	01	5478	0,50	BM7A	6521	10	6793
YTH2042T Mot. B&S Vanguard OHV 20hp	0,70	BKR5ES	2460	07	4803	0,50	BPMR7A	4626	02	5959
YTH20F42T Mot. Kohler 20hp	0,70	BKR5ES	2460	07	4803	0,50	BPMR7A	4626	02	5959
YTH2248 Mot. Kohler 22 hp	0,70	BKR5ES	2460	07	4803	0,50	BPMR7A	4626	02	5959
YTH2548 Mot. Kohler V-Twin 25 hp	0,70	BKR5ES	2460	07	4803	0,50	BPMR7A	4626	02	5959
ZTH4218 / QL Mot. Kawa. V-2 18 hp	0,60	BCPR6ES	2330	-	-	0,50	BPMR7A	4626	02	5959
ZTH5225XPQL Mot. Kawa. V-2 FH721V 25hp	0,60	BPR4ES	7222	-	-	0,50	BPMR6A	6726	08	5063
ZTH6123LPQL Mot. Kohler Refr. Liq 23hp	0,70	BKR5ES	2460	07	4803	0,70	BPMR7A	4626	02	5959
ZTH6123XPQL Mot. Kawa. V-2 FH721 23hp	0,60	BPR4ES	7222	-	-	0,50	BPMR7A	4626	02	5959
ZTH6125XPQL Mot. Kohler V-Twin 25hp	0,70	BKR5ES	2460	07	4803	0,50	BPMR7A	4626	02	5959
ZTH6126XPQL Mot. Kohler EFI 26hp	0,70	BKR5ES	2460	07	4803	0,50	BPMR7A	4626	02	5959
ZTH6127XPQL Mot. Kohler V-Twin 27hp	0,70	BKR5ES	2460	07	4803	0,50	BPMR7A	4626	02	5959
ZTH6215XPQL Mot. Kawa. V-Twin 25hp	0,70	BPR4ES	7222	-	-	0,70	BPMR7A	4626	02	5959
ZTH7226XPQL Mot. Kohler EFI 26hp	0,70	BKR5ES	2460	07	4803	0,50	BPMR7A	4626	02	5959
ZTH7227XPQL Mot. Kohler V-Twin 27hp	0,70	BKR5ES	2460	07	4803	0,50	BPMR7A	4626	02	5959

HUSQVARNA - Tronçonneuses

16, 24	0,50	BPM6A	7021	08	5063	340, 345	0,50	BPMR6A	6726	08	5063
20PS	0,50	BPMR7A	4626	02	5959	344 FE / 344 FG	0,50	BM7A	6521	10	6793
22 R / 22 RL	0,50	BPM6A	7021	08	5063	345 Mot. 45cc 2.7 hp	0,50	BPMR7A	4626	02	5959
23 Compact Mot. 38cc 2.2 hp	0,50	BPMR7A	4626	02	5959	346	0,50	BPMR7A	4626	02	5959
25 RL	0,50	BPM6A	7021	08	5063	346 XP E-Tech Mot. 50.1cc 3.62 hp	0,50	BPMR7A	4626	02	5959
32, 32 R, 32 RCL, 34	0,50	BPMR7A	4626	02	5959	346 XP Mot. 45cc 2.7 hp	0,50	BPMR7A	4626	02	5959
35	0,50	BM7A	6521	10	6793	346 XP / XPG Mot. 50.1cc 3.7 hp	0,50	BPMR7A	4626	02	5959
36	0,50	BPMR7A	4626	02	5959	350	0,50	BPMR6A	6726	08	5063
36 R	0,60	BPMR7A	4626	02	5959	350 Mot. 50cc 3 hp	0,70	BPMR7A	4626	02	5959
37	0,50	BM7A	6521	10	6793	353, 357, 385, 390, 395, 435, 440, 444	0,50	BPMR7A	4626	02	5959
40, 41, 42, 50, 51, 55, 61, 77, 136, 137	0,50	BPMR7A	4626	02	5959	353 E-Tech Mot. 51.7cc 3.3 hp	0,50	BPMR7A	4626	02	5959
40 Mot. 40cc 2.4 hp	0,50	BPMR7A	4626	02	5959	353 Mot. 52cc 3.2 hp, 357 Mot. 57cc 3.5 hp	0,50	BPMR7A	4626	02	5959
40 P	0,50	BPM6A	7021	08	5063	357 XP Mot. 56.5cc 4.4 hp	0,50	BPMR7A	4626	02	5959
41 Mot. 40cc 2.5 hp	0,50	BPMR7A	4626	02	5959	357 XP Mot. 57cc 3.5 hp	0,70	BPMR7A	4626	02	5959
42 D	0,50	BPMR6A	6726	08	5063	359 Mot. 59cc 3.6 / 3.9hp, 36 Mot. 36cc 2.2 hp	0,50	BPMR7A	4626	02	5959
42 Mot. 42cc 2.9 hp	0,50	BPMR7A	4626	02	5959	365 Mot. 65cc 4.2 hp, 371 XP Mot. 71cc 4.3 hp	0,50	BPMR7A	4626	02	5959
42 Spezial	0,50	BPMR6A	6726	08	5063	371 XPG, 372 XP Mot. 70.7cc 5.3 hp	0,50	BPMR7A	4626	02	5959
44 P	0,50	BPM6A	7021	08	5063	372 XP Mot. 71cc 4.3 hp	0,50	BPMR7A	4626	02	5959
45 Mot. 45cc 2.7 hp	0,50	BPMR7A	4626	02	5959	372 XPG Mot. 70.7cc 5.3 hp	0,50	BPMR7A	4626	02	5959
49 Mot. 49cc 3 hp, 51 Mot. 51cc 3.1 hp	0,50	BPMR7A	4626	02	5959	380 BT	0,70	CMR7H	3066	-	-
55 / 55 Rancher Mot. 53cc 3.3hp	0,50	BPMR7A	4626	02	5959	385 Mot. 85cc 5.2 hp	0,50	BPMR7A	4626	02	5959
55 D	0,50	BPMR6A	6726	08	5063	385 XP Mot. 85cc 5.2 hp	0,70	BPMR7A	4626	02	5959
61 D / 61 P	0,60	BPMR7A	4626	02	5959	390 XP / XPG / XPW Mot. 88cc 6.5 hp	0,50	BPMR7A	4626	02	5959
61 Mot. 62cc 4.1 hp	0,50	BPMR7A	4626	02	5959	394 XP, 394 XP Mot. 94cc 5.7 hp	0,50	BPMR7A	4626	02	5959
77 SS / 85 CD	0,50	BM7A	6521	10	6793	394 XPG, 395 XP Mot. 94cc 5.7 hp	0,50	BPMR7A	4626	02	5959
136 Mot. 36cc 2.2 hp	0,50	BPMR7A	4626	02	5959	395 XP Mot. 94cc 7.1 hp	0,50	BPMR7A	4626	02	5959
136 / 141 Mot. 40cc 2.5 hp	0,50	BPMR7A	4626	02	5959	395 XPG / XPW Mot. 94cc 7.1 hp	0,50	BPMR7A	4626	02	5959
140	0,50	BPM6A	7021	08	5063	435 Mot. 40.9cc 2.2 hp	0,70	BPMR7A	4626	02	5959
142	0,50	BPMR7A	4626	02	5959	440 Mot. 40.9cc 2.2 hp, 440E Mot. 40.9cc 2.4 hp	0,70	BPMR7A	4626	02	5959
154, 165	0,50	BPM6A	7021	08	5063	445 Mot. 45.7cc 2.8 hp	0,70	BPMR7A	4626	02	5959
160 CD	0,50	BPM6A	7021	08	5063	450, 455, 575, 3130	0,50	BPMR7A	4626	02	5959
160 S	0,60	BPMR7A	4626	02	5959	450 / 450 E Rancher Mot. 50.2cc 3.2 hp	0,70	BPMR7A	4626	02	5959
160 SD, 160 SG, 162 S	0,50	BPM6A	7021	08	5063	455 Rancher Mot. 50.2cc 3.2hp / Mot. 55.5cc 3.5hp	0,70	BPMR7A	4626	02	5959
163 CD, 163 CS	0,50	BM7A	6521	10	6793	460 Rancher	0,50	BPMR7A	4626	02	5959
163 S, 163 SE	0,50	BPM6A	7021	08	5063	460 Rancher Mot. 60.3cc 3.62 hp	0,70	BPMR7A	4626	02	5959
165 RX	0,60	BPMR7A	4626	02	5959	526 XP Mot. 59.8cc 4.7 hp, 545 Mot. 501.0cc 3.35hp	0,60	CMR6H	3365	12	4794
181 / CD / SE / SG	0,50	BM6F	6221	11	7683	550 XP Mot. 50.1cc 3.75 hp	0,60	CMR6H	3365	12	4794
234 SE, 234 SG	0,50	BM7A	6521	10	6793	550 XP Triobrake Mot. 50.1cc 3.75 hp	0,60	CMR6H	3365	12	4794
235 / P	0,50	BPMR7A	4626	02	5959	550 XPG Mot. 50.1cc 3.75 hp	0,60	CMR6H	3365	12	4794
238 / SE / SG	0,50	BPMR6A	6726	08	5063	555 Mot. 59.8cc 4.3 hp	0,60	CMR6H	3365	12	4794
240 / 240 E Mot. 28.2cc 2 hp	0,70	BPMR7A	4626	02	5959	560 XP	0,50	CMR6H	3365	12	4794
242 XP Mot. 42cc 3.1hp	0,50	BPMR7A	4626	02	5959	576 XP Autotune / XPW Autotun Mot. 73.5cc 5.7hp	0,70	BPMR7A	4626	02	5959
242 XPG, 242 XPG Mot. 42cc 3.1hp	0,50	BPMR7A	4626	02	5959	576 XP / XPG / XPW Mot. 73.5cc 5.7 hp	0,70	BPMR7A	4626	02	5959
244, 257, 260, 261, 268, 281, 323, 324	0,50	BPMR7A	4626	02	5959	927 PT5X Mot. 24.5cc 1.21 hp	0,50	BPMR7A	4626	02	5959
245 R / 245 RX	0,60	BPMR7A	4626	02	5959	2100 CDW	0,50	BM7A	6521	10	6793
250 PS / 254 FC / 254 G / 254 XP	0,50	BPMR7A	4626	02	5959	2100 W	0,50	BM6F	6221	11	7683
257 Mot. 57cc 3.8 hp, 26 RCL	0,50	BPMR7A	4626	02	5959	2101 CD / XP	0,50	BPMR7A	4626	02	5959
262 XP / XPG Mot. 62cc 4.8 hp	0,50	BPMR7A	4626	02	5959	3120 K	0,50	BPMR6A	6726	08	5063
265 RX, 266 SE / 266 SG / 266 XP / 268 K	0,50	BPMR7A	4626	02	5959	3120 XP, 3120 XP Mot. 118.8cc 8.4 hp	0,50	BPMR7A	4626	02	5959
268 Mot. 67cc 4.6 hp, 272 K	0,50	BPMR7A	4626	02	5959	3120 XP Mot. 119cc 7.3 hp	0,50	BPMR7A	4626	02	5959
272 XP Mot. 72cc 5.2 hp, 272 XPG	0,50	BPMR7A	4626	02	5959	6020 CH / 6020 MD / 6020 SH	0,60	B2-LM	1147	06	4740
281 XP Mot. 81cc 5.7hp	0,50	BPMR7A	4626	02	5959	6521 RS / 6522 CH / 6522 H	0,70	BCPR5ES	6130	07	4803
288 XP / XPG Mot. 88cc 6 hp	0,50	BPMR7A	4626	02	5959	Compact 35, Compact 37	0,50	BM7A	6521	10	6793
327, 334, 338, 339	0,50	BPMR7A	4626	02	5959	F 65	0,50	BPM6A	7021	08	5063
327 P4 / P5X Mot. 24.5cc 1.21 hp	0,50	BPMR7A	4626	02	5959	F 70	0,60	BM6A	5921	01	5478
334 T, 335 Mot. 35cc 2.2 hp	0,50	BPMR7A	4626	02	5959	G 65	0,50	BPM6A	7021	08	5063
335 XP Mot. 35cc 2.2 hp	0,70	BPMR7A	4626	02	5959	Husky 22 / Husky 23	0,50	BM7A	6521	10	6793
338 XPT Mot. 39cc 2.8 hp, 339 XP Mot. 39cc 2.4hp	0,50	BPMR7A	4626	02	5959	Husky 246 Mot. 46cc 3.3hp	0,50	BPMR7A	4626	02	5959
340 Mot. 41cc 2.5 hp	0,50	BPMR7A	4626	02	5959	Husky 32	0,80	BPMR7A	4626	02	5959
						Husky 33	0,50	BPMR7A	4626	02	5959
						Husky 35 / 35 VR	0,80	BPMR7A	4626	02	5959
						Husky 36 / 36 R	0,50	BPMR7A	4626	02	5959
						Husky 38 / 38 VR	0,80	BPMR7A	4626	02	5959
						Husky 39 R / 40 / 41 / 42 / 44 / 45 / 49	0,50	BPMR7A	4626	02	5959
						Husky 50 / 51 / 55	0,80	BPMR7A	4626	02	5959
						Husky 61 / 65 / 66 / 77 / A 65 / A 77 / B 65	0,50	BPMR7A	4626	02	5959
						K 65	0,50	BPM6A	7021	08	5063
						PS 50	0,50	BPMR6A	6726	08	5063
						R 65	0,50	BPM6A	7021	08	5063
						Rancher 40 / 50 / 61	0,50	BPMR6A	6726	08	5063
						S 77	0,50	BPMR7A	4626	02	5959
						T 435 Mot. 32.2cc 21 hp	0,80	CMR7H	3066	-	-

HYDRA MAC - Manutention

5C - Mot. Tecumseh HH-160	0,60	B6HS	4510	-	-
8C Mot. Onan NHCV	0,60	BR6ES	4922	-	-
12C - Mot. Ford 98 ci., 12CII - Mot.Chrysler H-105	0,60	BP6ES	7811	04	7678

Modèle

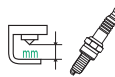
 N° STOCK BOÎTE
 N° BLISTER
 N° STOCK BLISTER

HYDRA MAC - Manutention				
20C - Mot. Ford 172 ci.	0,60	B-6L	3212	- -
20CII - Mot. Mazda 121 ci.	0,60	BP6ES	7811	04 7678
Big Mac 18 - Mot. Ford 172 ci.	0,60	B-6L	3212	- -
Mini Mac 5 - Mot. Tecumseh HH-160	0,60	B6HS	4510	- -
Mithey Mac 8B Mot. Onan NHC	0,60	BR6ES	4922	- -
Mithey Mac II-10 - Mot. Ford 98 ci.	0,60	BP6ES	7811	04 7678

HYSTER - Manutention				
20C150-SC180-TC200 Mot. Hercules	0,60	B6S	3510	09 6048
Carrier S60, S70, S80	0,60	AB-6	2910	- -
H3B	0,60	B6ES	7310	- -
H20-30E	0,60	AB-6	2910	- -
H30-60H	0,60	B-6L	3212	- -
H40H, H50H	0,60	B-6L	3212	- -
H60, H70C, H80C, H60-80B	0,60	AB-6	2910	- -
H100-120B, H, H100-140C, H100-150C	0,60	AB-6	2910	- -
H110F, H130/F, H150F	0,90	YR5	7052	- -
H111-150F, H150-250DE	0,70	UR4	6630	- -
H150-225E (->191268)	0,60	B6S	3510	09 6048
H150-225E (191269->)	0,60	BP5ES	6511	03 6854
H150-275H, H300A	0,70	UR4	6630	- -
H150E-H275E, H150F, H200-H400	0,90	YR5	7052	- -
H250-300A (> 191268)	0,60	B6S	3510	09 6048
H250-300A (191269->)	0,60	BP5ES	6511	03 6854
H250A, H30-60F	0,60	B6S	3510	09 6048
H35XL - Mot. 4 Cyl.. Mazda	0,80	BPR4ES	7222	- -
H360-400A, H360-620B	0,60	B6ES	7310	- -
H360-460A, H360-460KE	0,60	AB-6	2910	- -
H700-800A, M200-300F - Culot long	0,60	B5ES	6410	- -
KD Krane	0,60	B6S	3510	09 6048
KE Krane	0,60	AB-6	2910	- -
M2, M3, MD Carrier, MH - Ø14 x 9,5 mm	0,60	B6S	3510	09 6048
M200-300E, M200-300F - Culot court	0,60	B6S	3510	09 6048
M200-400H	0,60	BP5ES	6511	03 6854
MH3 Carrier	0,60	AB-6	2910	- -
P40A-P50A	0,80	UR5	2771	- -
P60-80A, P60A-80A, KE, QC20, QN20, QT20	0,60	AB-6	2910	- -
P125-180A (> 191268)	0,60	B6S	3510	09 6048
P125-180A (191269->)	0,60	BP5ES	6511	03 6854
P150B-P200B	0,90	YR5	7052	- -
RC150-SC180-TC200 - Mot.Chrysler IND52	0,60	B6S	3510	09 6048
RC150-SC180-TC200 - Mot.Chrysler IND53	0,60	B6ES	7310	- -
RC150-SC180-TC200 Mot. Hercules	0,60	B6ES	7310	- -
S20-30A, S20A-30A, S30-50B, S30-50C	0,60	AB-6	2910	- -
S30-60ES	0,90	YR5	7052	- -
S30B-S60B	0,70	UR4	6630	- -
S30C, S40C, S50C	0,60	BP5ES	6511	03 6854
S60-100A, S60-100B	0,60	AB-6	2910	- -
S60B	0,90	YR5	7052	- -
S60E - Mot. Chevrolet 250 ci.	0,70	UR4	6630	- -
S70B, S80B, S70B-S100B	0,90	YR5	7052	- -
S70E, S80E - Mot. Chevrolet 250 ci.	0,70	UR4	6630	- -
S100B	0,90	YR5	7052	- -
S100E - Mot. Chevrolet 250 ci.	0,70	UR4	6630	- -
S125-150A	0,60	AB-6	2910	- -
Straddle Carriers - Mot.Chrysler 53	0,60	B5ES	6410	- -
Tous modèles - Mot. GM 350 ci.	0,60	YR55	7240	- -
Tous modèles - Mot. Ford 172 / 192 ci	0,60	B-6L	3212	- -
Tous modèles - Mot.GM 151 ci.	0,60	BP5ES	6511	03 6854
Tous modèles - Mot.GM 153 ci.	0,60	B-6L	3212	- -
Tous modèles - Mot.GM 250 ci. (Culot court)	0,60	B6S	3510	09 6048
Tous modèles - Mot.GM 250 ci. (Culot long)	0,60	B5ES	6410	- -
Turret Tug UC30 / UE30 / YC40 / YE40 / YT40	0,60	AB-6	2910	- -
U30-YC40-HE50, UE30-YC40-HE50	0,60	AB-6	2910	- -
XF60-VA70-ZA80 - Culot court	0,60	B6S	3510	09 6048

IDEAL - Débroussailleuses				
SX 230S, 260S, 360S / W, 430S / W, 540W	0,60	BM6A	5921	01 5478

IDEAL - Tondeuses				
Ø14 mm	0,70	BR6S	3522	09 6048
Ø18 mm	0,80	AB-6	2910	- -

Modèle

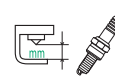
 N° STOCK BOÎTE
 N° BLISTER
 N° STOCK BLISTER

ILO - Tondeuses				
Tous modèles	0,50	B6HS-5	6154	- -

INDIAN - Tronçonneuses				
5-12, Super 5-12, 547H	0,60	BMR6A	7421	01 5478
50	0,80	B6S	3510	09 6048
351 / 352 / 547 / 652, 3CD, 5-12, 5CD, 7CD, 35	0,80	B6S	3510	09 6048
561 / 562 / 582	0,80	B5HS	4210	- -
561H / 582H	1,00	B7HS	5110	- -
651	0,60	B-4L	3112	- -
Super 50 / Super 651, Super 60, Thunderbolt 651	0,60	B-4L	3112	- -

INTERNATIONAL - Manutention				
444, 3444	0,60	B6HS	4510	- -
4120 - Mot. Kohler	0,60	B-6L	3212	- -
4130 Mot. Onan	0,60	BR6ES	4922	- -
4135	0,60	BR6ES	4922	- -
4140 - Mot. Ford / Mot.Chrysler	0,60	BP6ES	7811	04 7678
4150 - Mot. Ford	0,60	B-6L	3212	- -
4150 - Mot. Mazda	0,60	BP6ES	7811	04 7678
7000	0,60	B6HS	4510	- -
Crawler T340	0,60	AB-6	2910	- -

INTERNATIONAL HARVESTER - Générateurs				
60, 70, 71, 72, 73, 86	0,60	B6S	3510	09 6048
100, 102, 104->109, 122, 123->129, 147, 149, 169	0,60	B-6L	3212	- -
284	0,60	BP5ES	6511	03 6854
303	0,60	BP6S	3111	- -
354, B414	0,60	B6HS	4510	- -
815, 915	0,60	B8S	3810	- -
4000, 5000, 5500 w/AMC 232	0,90	BPR5ES	7422	03 6854
4000, 5000, 5500 W/HB 225	0,90	BPR6ES	7822	04 7678
800, 1000, 1200, 1250, 1450, 1650	0,60	B-6L	3212	- -
Cadet 55R, 75E, 75R, 76E, 76R	0,60	BM6A	5921	01 5478
Field Harvester, 20C, 36	0,60	B6S	3510	09 6048

INTERNATIONAL - Tondeuses				
55, 75, 76, 85	0,60	BM6A	5921	01 5478
60, 70, 71, 72, 86	0,60	B6S	3510	09 6048
80, 81, 111	0,60	BM6A	5921	01 5478
182, 282, 382, 482	0,70	BM6A	5921	01 5478
582	0,60	BR6S	3522	09 6048
682, 782	0,60	UR4	6630	- -
800, 1000, 1100, 1200	0,60	B-6L	3212	- -
982	0,60	TR5	2238	- -
100, 102, 104, 105	0,60	B-6L	3212	- -
106->109, 122->129, 149, 1250, 1450, 1650	0,60	B-6L	3212	- -
1030, 1225, 1238	0,70	B2-LM	1147	06 4740
1325, 1330, 1440	0,70	BKR5ES	2460	07 4803
1430, 1730	0,70	UR4	6630	- -
1641, 2182	0,70	BKR5ES	2460	07 4803
1861, 1862, 2062	0,70	UR4	6630	- -
3309, 3310, 3311, 3312, 3313, 3314, 3315	0,80	BM4A	5628	- -
332, 333, 334, 335, 3319, 3320, 3321, 3322	0,80	BM4A	5628	- -
3323, 3324, 3325	0,80	BM4A	5628	- -
Mot. B&S Twin	0,70	BR6S	3522	09 6048
Mot. Kawasaki 5.2 hp	0,60	BM6A	5921	01 5478
Mot. Kawasaki 20 hp	0,60	BMR4A	5728	- -
Mot. Kawasaki OHV 3.7 / 5.3 / 7.9	0,70	BP4ES	6928	- -
Mot. Kawasaki OHV 9 / 11 / 13 / 14 / 17hp	0,70	BP4ES	6928	- -
Mot. Kohler 8 / 10 / 12 / 14 / 16 / 20 hp	0,60	B-6L	3212	- -
Mot. Kohler 17 hp	0,60	UR4	6630	- -
Mot. Kohler OHV	1,10	BKR5ES-11	2382	- -
Mot. Onan	0,60	TR5	2238	- -
Mot. Tecumseh	0,70	BR6S	3522	09 6048
Mot. Yanmar	0,80	BPR5ES	7422	03 6854

IRUS - Tondeuses				
Hirth, ILO	0,50	AB-6	2910	- -
Mot. F&S - Ø14 mm	0,50	B7HS	5110	- -
Mot. F&S - Ø18 mm	0,50	AB-6	2910	- -

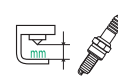
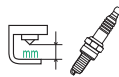

ISCO - Manutention

Shuttle Wagon	0,60	AR6FS	3323	-	-
---------------	------	-------	------	---	---

ISEKI - Débroussailleuses

ICD 20F / 22 / 25A1 / 35A1 / 40A1 / 50	0,50	BM6	2027	-	-
--	------	-----	------	---	---

ISEKI - Générateurs

KF24G-1, KF340, 341, 342, 344, 345, 346	0,60	B6S	3510	09	6048
KF441, 442, 444, 640	0,60	B6S	3510	09	6048
KF453/T, 550/T	0,60	B-4	3210	-	-
KF521, 522, KF53G-2X	0,60	B6HS	4510	-	-
KF90GT, 710, 900, 1300, 1320	0,60	B-4	3210	-	-
KT30-1V, KT330	0,60	B6S	3510	09	6048
KT290, 350	0,60	B6HS	4510	-	-

ISHIKAWAJIMA-SHIBAURA - Débroussailleuses

B 18, 20 / DU, 24 / DU, 30, 31 / DU, 35 / DU	0,60	BPMR7A	4626	02	5959
H 18D / 20D / 23D / 26D / 35D	0,60	BPMR7A	4626	02	5959
SB 19 / 24 / 30 / 40, SCK 30D, SCY 24 / 24A	0,70	BMR6A	7421	01	5478

JACOBSEN - Tondeuses

Mot. B&S Intek Pro OHV 6.5 hp	0,70	BKR5ES	2460	07	4803
Mot. Clinton	0,70	BR6S	3522	09	6048
Mot. Ford	0,60	B-6L	3212	-	-
Mot. Fuji-Robin EY25W	0,60	B6HS	4510	-	-
Mot. Greensmower	0,60	B-2	3110	-	-
Mot. Honda 4 hp	0,70	BPMR6A	6726	08	5063
Mot. Horizontal	0,60	B-2	3110	-	-
Mot. Kawa. OHV 15/17hp / V-Twin OHV 15/17 hp	0,60	BCPR6ES	2330	-	-
Mot. Kawasaki V-Twin OHV 21 hp	0,60	BPR4ES	7222	-	-
Mot. Kohler K181 8 hp	0,60	B6S	3510	09	6048
Mot. Kohler K241 10 hp / K301 12 hp	0,80	B-6L	3212	-	-
Mot. Kohler K321 14 hp / K341 16 hp	0,80	B-6L	3212	-	-
Mot. Kohler K361 18 hp / K582 23 hp	0,80	B-6L	3212	-	-
Mot. Putting Greensmower	0,60	B-2	3110	-	-
Mot. Robin	0,60	B6HS	4510	-	-
Mot. Tecumseh	0,60	B6S	3510	09	6048
Mot. Vertical	0,60	B4-LM	3410	05	4358

JAEGER - Manutention

LP12 Auto Scoop, MIC	0,60	AB-6	2910	-	-
----------------------	------	------	------	---	---

JAMAKA - Tondeuses

Mot. B&S	0,70	BR2-LM	5798	06	4740
----------	------	--------	------	----	------

JARI - Tondeuses

Mot. B&S / Mot. Kohler / Tecumseh	0,70	BR2-LM	5798	06	4740
-----------------------------------	------	--------	------	----	------

JIM SAVAGE - Tronçonneuses

Maxi 350 / Pro 580 / Super 100	0,70	BMR6A	7421	01	5478
--------------------------------	------	-------	------	----	------

JOBU - Débroussailleuses

Tous modèles	0,70	BMR6A	7421	01	5478
--------------	------	-------	------	----	------

JOBU - Tronçonneuses

L6 / L8 / L86-S	0,60	BPM6A	7021	08	5063
LF50 / LP6, Micro 25 / 25 CVA / L35	0,60	BMR6A	7421	01	5478
SL-2 / SL-21 / SL-3	0,60	BPM6A	7021	08	5063
SL-35	0,60	BM6A	5921	01	5478

JOHN DEERE - Débroussailleuses

21C, 21S	0,60	BPMR6A	6726	08	5063
25 S, 30 S, 38 B, 250G, 300 G, 400 G	0,70	BPMR7A	4626	02	5959
82G, 83G	0,60	BM4A	5628	-	-
85G	0,80	BR4-LM	4133	05	4358
162	0,60	BM4A	5628	-	-
213E	0,70	BMR6A	7421	01	5478
350G	0,70	BMR6A	7421	01	5478

1032	0,50	BR6S	3522	09	6048
BC1600 / C1200	0,70	BPMR7A	4626	02	5959
EH2342, EH2659, H20D, H20S	0,70	BMR6A	7421	01	5478
Mot. B&S	0,70	BR2-LM	5798	06	4740
Mot. Kawasaki FA210Y 5.2 hp	0,70	BMR6A	7421	01	5478
Mot. Kawasaki FB460V 12.5 hp	0,70	BMR4A	5728	-	-
Mot. Kawasaki FC290Y 9 hp	0,80	BPR5ES	7422	03	6854
Mot. Kioritz	0,50	BMR6A	7421	01	5478
Mot. Kohler K181 8 hp	0,70	BR6S	3522	09	6048
Mot. Kohler K241 10 hp / K301 12 hp	0,70	B-6L	3212	-	-
Mot. Kohler K321 14 hp / K341 16 hp / K532 20 hp	0,70	B-6L	3212	-	-
Mot. Kohler KT17 17 hp	0,60	UR4	6630	-	-
Mot. Tecumseh	0,70	BR6S	3522	09	6048
PS2683	0,70	BMR6A	7421	01	5478
S1400	0,70	BPMR7A	4626	02	5959
SE23, T23s, T26sb, TB26sb, T40sb	0,70	BMR6A	7421	01	5478
T105C, T105S, XT105	0,60	BM6A	5921	01	5478
T30c, T30s, T30bs	0,70	BPMR6F	1270	-	-
XT 120 / SE, 140 / B / SB, 105SB, 170 / B, 250B	0,70	BMR6A	7421	01	5478

JOHN DEERE - Générateurs

2, 4	0,60	BM6A	5921	01	5478
2 E, 3 E	0,60	BPM7A	7321	02	5959
4 E	0,60	BM6A	5921	01	5478
5	0,60	B6S	3510	09	6048
11 A / 12 A / 25 / 30 / 40 - Ø 18 mm	0,60	AB-6	2910	-	-
11 A / 12 A / 25 / 30 / 40 Mot. J. Deere	0,60	B-6L	3212	-	-
11 A / 12 A / 25 / 30 / 40 Mot. Hercules	0,60	B6S	3510	09	6048
45 / 55 Mot. Hercules	0,60	B6S	3510	09	6048
50, 60	0,80	AB-6	2910	-	-
65 Mot. Hercules, 80, 90 Mot. Hercules	0,60	B6S	3510	09	6048
105 - Ø 18 mm	0,60	AB-6	2910	-	-
105 Peanut Comb.111	0,60	B-6L	3212	-	-
202	0,60	BR6FS	4323	-	-
225	0,60	BMR6A	7421	01	5478
250 G	0,70	B2-LM	1147	06	4740
303	0,60	BR6FS	4323	-	-
321	0,60	BPMR6A	6726	08	5063
330 / 420 / 430 / 440	0,60	B-6L	3212	-	-
362 - Ø 18 mm	0,60	AB-6	2910	-	-
440 G	0,70	B2-LM	1147	06	4740
530	0,80	AB-6	2910	-	-
550	0,60	BR6HS	3922	-	-
550 GE	0,70	B2-LM	1147	06	4740
620 / 630	0,80	AB-6	2910	-	-
750	0,60	BR6S	3522	09	6048
820	0,60	B6S	3510	09	6048
824	0,60	BPMR6A	6726	08	5063
830	0,60	B6S	3510	09	6048
1000	0,60	BR6S	3522	09	6048
1010	0,60	B-6L	3212	-	-
1020	0,60	BP5ES	6511	03	6854
1026	0,60	B4-LM	3410	05	4358
1100 / 1400	0,60	BR6S	3522	09	6048
1520	0,60	BP5ES	6511	03	6854
1800	0,70	BPR4HS	7823	-	-
2010	0,60	B-6L	3212	-	-
2020 / 2030	0,60	BP5ES	6511	03	6854
2300	0,70	BPR4HS	7823	-	-
2510	0,60	BP5ES	6511	03	6854
3010 / 3020	0,40	AB-6	2910	-	-
3200	0,70	BPR4HS	7823	-	-
3300	0,60	BR6FS	4323	-	-
4010 / 4020	0,40	AB-6	2910	-	-
4400	0,60	BR6FS	4323	-	-
5000	0,60	BR4HS	3322	-	-
6600	0,60	BR6FS	4323	-	-
5000 W	0,60	BR6HS	3922	-	-
6602 - Ø 18 mm, 7700 - Ø 18 mm	0,60	AB-6	2910	-	-
A, AR-AO, B, G, H	0,80	AB-6	2910	-	-
B&S	0,60	B2-LM	1147	06	4740
B&S 116	0,60	BR6S	3522	09	6048
DP 6000	0,70	BPR4ES	7222	-	-
FA 210 / 210 Y, FB 460 V	0,70	BMR6A	7421	01	5478
FB 540 V 17hp	0,60	BPR5ES	7422	03	6854
FC 150	0,80	BP6ES	7811	04	7678

Modèle

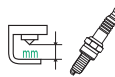
 N° STOCK BOÎTE
 N° BLISTER
 N° BLISTER

JOHN DEERE - Générateurs				
FC 290 V	0,80	BPR5ES	7422	03 6854
FC 290 V 9hp	0,60	BPR5ES	7422	03 6854
FC 420 / 540 V	0,80	BPR5ES	7422	03 6854
FD 440 / 590	0,70	BMR6A	7421	01 5478
FE 1	0,60	BP5ES	6511	03 6854
FG 150	0,70	BP4HS	3611	- -
G 2500 K / 4400 K / 5500 K / 5500 KE	0,80	BPR5ES	7422	03 6854
Kioritz	0,60	BM6A	5921	01 5478
Kohler K181 8 hp	0,60	B6S	3510	09 6048
Kohler K241 10 / 12 hp & K321 14 / 16 / 20 hp	0,60	B-6L	3212	- -
Kohler KT17 17hp	0,60	UR4	6630	- -
L, LA-L1, M	0,60	B-6L	3212	- -
Onan 316, 318, 420	0,60	TR5-1	7060	- -
R Series	0,60	AB-6	2910	- -
Tecumseh	0,60	B6S	3510	09 6048
Yanmar F912 / F932	0,60	BP5ES	6511	03 6854

JOHN DEERE - Manutention				
60 / 440, 1010, Série 2010	0,60	B-6L	3212	- -
70, JD14, 90, 125, 3010, 4010	0,60	AB-6	2910	- -
840 - Start Eng.	0,60	B6S	3510	09 6048
JD24, JD24A, 170	0,60	AB-6	2910	- -
JD300/B, 301A, 302A, JD310, 350/B/C, 380, 400	0,60	BP5ES	6511	03 6854
JD401A/B/C, 440/B, 480/A	0,60	BP5ES	6511	03 6854
JD500/A/B, 600	0,60	AB-6	2910	- -
JD544	0,60	BP5ES	6511	03 6854

JOHN DEERE (CUT OFF SAW) - Tronçonneuses				
380 MS / 880 MS	0,80	BPMR7A	4626	02 5959

JOHN DEERE - Tondeuses				
12 PB / SB, 14 PZ / SZ, F725	0,70	BR2-LM	5798	06 4740
14 PT / SB / SC / SE / ST / SX	0,80	BPR5ES	7422	03 6854
20SR7	0,80	BMR6A	7421	01 5478
56 / 57 / 66 / 68 / R72 / D28 / S92	0,70	BR6S	3522	09 6048
636M Mot. Kawa. FS600V-AS28R 18 hp	0,80	BPR4ES	7222	- -
648M Mot. Kawa. FS691V-AS17R 23 hp	0,80	BPR4ES	7222	- -
648R Mot. Kawasaki FX730V 22 hp	0,80	BPR4ES	7222	- -
652B Mot. Kawasaki FX691V 22 hp	0,80	BPR4ES	7222	- -
652M Mot. Kawa. FS691V-AS17R 23 hp	0,80	BPR4ES	7222	- -
652R Mot. Kawasaki FX730V 23.5 hp	0,80	BPR4ES	7222	- -
652R Mot. Kohler EFI ECV740 24.6 hp	0,70	BKR5ES	2460	07 4803
661R Mot. Kawasaki FX730V 23.5 hp	0,80	BPR4ES	7222	- -
661R Mot. Kohler EFI ECV740 24.6 hp	0,70	BKR5ES	2460	07 4803
JA 62 / 65, JS 60 / 61 / 63	0,70	BR2-LM	5798	06 4740
JE75, JX75, JX85	0,80	BPR5ES	7422	03 6854
JS63C - Mot. B&S Intek 6.5 / 6.75 hp	0,70	BKR5ES	2460	07 4803
Mot. B&S 116	0,70	BR6S	3522	09 6048
Mot. B&S 4 / 6 / 13 hp	0,70	BR2-LM	5798	06 4740
Mot. B&S 6.5 / 6.75 hp	0,70	BKR5ES	2460	07 4803
Mot. B&S Intek OHV AVS 17 hp	0,70	BKR5ES	2460	07 4803
Mot. B&S Intek V-Twin OHV 20 hp	0,70	BKR5ES	2460	07 4803
Mot. B&S V-Twin OHV 16 / 18 hp	0,70	BKR5ES	2460	07 4803
Mot. Kawasaki 3.8 hp	0,80	BMR6A	7421	01 5478
Mot. Kawasaki 14 / 17 / 19 / 23 / 25 / 27 / 29 hp	0,80	BPR5ES	7422	03 6854
Mot. Kawasaki FC150 5 hp	0,70	BP6ES	7811	04 7678
Mot. Kawasaki FC420V 14 hp	0,80	BPR5ES	7422	03 6854
Mot. Kawasaki FC540V 17 hp	0,50	BP5ES	6511	03 6854
Mot. Kawasaki FH601V 19 hp	0,60	BPR4ES	7222	- -
Mot. Kawasaki OHV 4 / 5 / 5.3 / 6 hp	0,80	BPR5ES	7422	03 6854
Mot. Kawasaki TB480V	0,70	BM6A	5921	01 5478
Mot. Kawasaki V-Twin OHV 17 hp	0,90	BCPR6ES	2330	- -
Mot. Kawasaki V-Twin OHV 18 / 20 hp	0,80	BMR6A	7421	01 5478
Mot. Kawasaki V-Twin OHV 21 / 23 / 25 hp	0,60	BPR4ES	7222	- -
Mot. Kohler 13 hp	0,80	BKR5E	7938	07 4803
Mot. Kohler 23 hp	0,70	B-6L	3212	- -
Mot. Kohler Command V-Twin OHV 23 / 25 hp	0,70	BKR5ES	2460	07 4803
Mot. Kohler CV135 13 hp & OHV 15 hp	1,00	BKR5ES-11	2382	- -
Mot. Kohler OHV 16 / 17.5 hp	0,70	BKR5ES	2460	07 4803
Mot. Onan 316 / 318 / 420	0,60	TR5	2238	- -
Mot. Tecumseh	0,70	BPMR7A	4626	02 5959
Mot. Yanmar F912 / F932	0,60	BP5ES	6511	03 6854
WG32A Mot. Kawasaki FS481V 14.5 hp	0,80	BPR4ES	7222	- -

Modèle

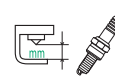
 N° STOCK BOÎTE
 N° BLISTER
 N° BLISTER

WG36A / WG48A Mot. Kawasaki FS481V 14.5 hp	0,80	BPR4ES	7222	- -
WH36A Mot. Kawasaki FS481V 14.5 hp	0,80	BPR4ES	7222	- -
WH48A / WH52A Mot. Kawasaki FS600V 18.5 hp	0,80	BPR4ES	7222	- -
WH61A Mot. Kawasaki FS600V 23.5 hp	0,80	BPR4ES	7222	- -
WHP48A / WHP52A Mot. Kawasaki FS481V 14.5hp	0,80	BPR4ES	7222	- -
WHP61A Mot. Kawasaki FS600V 23.5 hp	0,80	BPR4ES	7222	- -
X300 / X300R Mot. Kawasaki V-Twin, OHV 18.5 hp	0,80	BPR4ES	7222	- -
X304 / X310 Mot. Kawasaki V-Twin, OHV 18.5 hp	0,80	BPR4ES	7222	- -
X500 / X530 Mot. Kawasaki V-Twin, OHV 24 hp	0,80	BPR4ES	7222	- -
X720 / X720SE Mot. Kawasaki V-Twin OHV 25.5 hp	0,80	BPR4ES	7222	- -
X724 Mot. Kawasaki V-Twin OHV 25.5 hp	0,80	BPR4ES	7222	- -
X728 / X728SE Mot. Kawasaki V-Twin OHV 25.5 hp	0,80	BPR4ES	7222	- -
X729 / X730 Mot. Kawasaki V-Twin OHV 25.5 hp	0,80	BPR4ES	7222	- -
X740 / X744 Mot. Kawasaki V-Twin, OHV 24 hp	0,80	BPR4ES	7222	- -
X748 / X748SE Mot. Kawasaki V-Twin, OHV 24 hp	0,80	BPR4ES	7222	- -
X749 Mot. Kawasaki V-Twin, OHV 24 hp	0,80	BPR4ES	7222	- -
Z915B Mot. Kohler PCV740 23.9 hp	0,70	BKR5ES	2460	07 4803
Z920M / Z920R Mot. Kawasaki FX730V 23.5 hp	0,80	BPR4ES	7222	- -
Z925M Mot. Kohler EFI, Flexfuel FCV740 25hp	0,70	BKR5ES	2460	07 4803
Z930M Mot. Kawasaki FX801V 25.5 hp	0,80	BPR4ES	7222	- -
Z930M Mot. Kohler EFI ECV749 26.5 hp	0,70	BKR5ES	2460	07 4803
Z930R Mot. Kawasaki FX801V 25.5 hp	0,80	BPR4ES	7222	- -
Z950M / Z950R Mot. Kawasaki FX850V 27 hp	0,80	BPR4ES	7222	- -
Z960R 31 hp Mot. Kawasaki FX921V	0,80	BPR5ES	7422	03 6854
Z970R 35 hp Mot. Kawasaki FX1000V	0,80	BPR5ES	7422	03 6854

JOHN DEERE - Tronçonneuses				
8, 9, 12, 14, 15, 17, 18, 19	0,70	BM7A	6521	10 6793
28, 30, 50	0,70	BMR6A	7421	01 5478
40 V	0,60	BMR6A	7421	01 5478
55 SV	0,80	BPMR7A	4626	02 5959
55V	0,70	BPM6A	7021	08 5063
61	0,70	BM7A	6521	10 6793
80 V	0,80	BPMR7A	4626	02 5959
81, 82, 91	0,70	BM7A	6521	10 6793
200CS, 230CS, 550CS	0,80	BPMR7A	4626	02 5959
300 CS	0,60	BPM6A	7021	08 5063
350 CS	0,70	BM7A	6521	10 6793
820, 840	0,80	BPMR7A	4626	02 5959
CS 36 / 40 / 46 / 52 / 56 / 62 / 71 / 81	0,50	BPMR7A	4626	02 5959
R70 EV, S80 / S82	0,70	BPMR6A	6726	08 5063

JOHNSON - Tondeuses				
Mot. B&S	0,70	BR2-LM	5798	06 4740
Mot. Clinton, Continental	0,70	BR6S	3522	09 6048

JONSERED - Débroussailleuses				
BP 40 / 40 Combi	0,70	BPMR7A	4626	02 5959
FT5, RT5	0,70	BR2-LM	5798	06 4740
GR 26 / 26 Combi, GR 26 D/L, GR 32 D / L	0,70	BPMR7A	4626	02 5959
GR 36 / 41 / 44 / 50 / 50 Pro, GR 260 / 320	0,70	BPMR7A	4626	02 5959
GR 2026 / L / D / CL, 2032L / D, 2036, GR 203020	0,70	BPMR7A	4626	02 5959
GT 21L / 22L / 24L / 25L / 26L	0,50	BPMR6A	6726	08 5063
RS 38	0,50	B6HS-5	6154	- -
RS 40 / 44 / 45	0,50	BPMR7A	4626	02 5959
RS 51 Pro / 52	0,70	BPMR7A	4626	02 5959

JONSERED - Générateurs				
BV 32	0,40	BPM6A	7021	08 5063
WP 25	0,60	BPM6A	7021	08 5063

JONSERED - Outils Divers				
BV 32	0,40	BPM6A	7021	08 5063
HT 21	0,70	BPM6A	7021	08 5063
HT 24 / WP 25	0,60	BPM6A	7021	08 5063

JONSERED - Tondeuses				
LT 13 - Mot. B&S 13 hp	0,70	BR2-LM	5798	06 4740
LT 15 - Mot. B&S OHV 14.5 hp	0,90	BKR5E	7938	07 4803
LT 16 / 18 - Mot. B&S Intek OHV 15.5 / 18hp	0,90	BKR5E	7938	07 4803

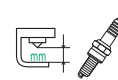
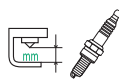

JONSERED - Tronçonneuses

45E	0,80	BPMR7A	4626	02	5959
50, 51	0,70	BPMR6A	6726	08	5063
90E	0,80	BPM7A	7321	02	5959
90W	0,70	BPM6A	7021	08	5063
62	0,50	BPM6F	5950	-	-
111	0,80	BPMR7A	4626	02	5959
361 / AV	0,70	BM7A	6521	10	6793
451E, 452	0,80	BPM6F	5950	-	-
455, 521, 535	0,70	BPMR6A	6726	08	5063
490 (siège conique)	0,80	BPMR6F	1270	-	-
490 (siège plat)	0,80	BPM7A	7321	02	5959
510 / M, 520 SP	0,80	BPMR6F	1270	-	-
510SP	0,70	BPM6A	7021	08	5063
525 (siège conique), 590 (siège conique)	0,80	BPMR6F	1270	-	-
670	0,70	BPM6A	7021	08	5063
670 Champ	0,80	BPM6A	7021	08	5063
670 Super	0,50	BPMR7A	4626	02	5959
810, 821, 840, 1020, 2041, 2045, 2054	0,80	BPMR7A	4626	02	5959
820, 840	0,80	BPM7A	7321	02	5959
930 Super, 2055, 2083	0,70	BPMR6A	6726	08	5063
2095, 2883	0,70	BPM6A	7021	08	5063
2036, 2040, 4104, 6000	0,70	BPMR6A	6726	08	5063
2036, 2040 Turbo	0,80	BPMR7A	4626	02	5959
2041 Turbo	0,80	BPM6A	7021	08	5063
2065, 2072 Turbo, 2077 Turbo, 2141, 2145	0,80	BPMR7A	4626	02	5959
2149 / 2149W Turbo, 2150 / 2159 / 2159W Turbo	0,80	BPMR7A	4626	02	5959
2163 / 2163W / 2165 Turbo, 2171 / 2171W Turbo	0,80	BPMR7A	4626	02	5959
CS 2137 / 2147 / 2152 / 2245 / 2245 S / 2250 S	0,50	BPMR7A	4626	02	5959
CS 2252, CS 2253 / 2253 WH	0,50	CMR6H	3365	12	4794
HP36 Power Pruner	0,70	BPMR6A	6726	08	5063
M52E, M45ES, M66, M70, M90	0,80	BPMR7A	4626	02	5959
M111, M450 / 451EV / 452 / 495P	0,80	BPMR7A	4626	02	5959
M510, M510M	0,80	BPM6F	5950	-	-
M510SP	0,70	BPM6A	7021	08	5063
M801	0,80	BPM7A	7321	02	5959
Mini Sawmill 600+ Mot. W/2095 Turbo	0,70	BPMR6A	6726	08	5063
Pro 35, RS 40 / 45 / 51	0,70	BPMR6A	6726	08	5063
RS 52E	0,80	BPM7A	7321	02	5959
XF85 / XG85	0,80	B6HS	4510	-	-

JUNGHEINRICH - Outils Divers

TFG 16 AK / AS, TFG 20 AK / AS	0,80	BPR2ES	2264	-	-
TFG 20 BK / BS, TFG 25 BK / BS, TFG 30 BK / BS	1,00	BPR4FS	1127	-	-
TFG 40 CK / CS	1,60	TR55	3951	-	-
TFG 45 CK / CS, TFG 50 CK / CS, TFG 540 / 545	1,60	TR55	3951	-	-
TFG 316 (->03-2006)	0,80	BPR2ES	2264	-	-
TFG 316 (04-2006->)	0,80	FR2A-D	4768	-	-
TFG 316 s, TFG 320 (->03-2006)	0,80	BPR2ES	2264	-	-
TFG 320 (04-2006->)	0,80	FR2A-D	4768	-	-
TFG 320 s	0,80	BPR2ES	2264	-	-
TFG 420 (->07-2007), TFG 420 s	1,00	BPR4FS	1127	-	-
TFG 425 (->06-2004)	1,00	BPR4FS	1127	-	-
TFG 425 (07-2004->)	0,80	FR2A-D	4768	-	-
TFG 425 s, TFG 430 (->06-2004)	1,00	BPR4FS	1127	-	-
TFG 430 (07-2004->)	0,80	FR2A-D	4768	-	-
TFG 430 s	1,00	BPR4FS	1127	-	-
TFG 435	0,80	FR2A-D	4768	-	-
TFG 540 s (->03-2012), TFG 545 s (->03-2012)	1,60	TR55	3951	-	-
TFG 550, TFG 550 s (->03-2012)	1,60	TR55	3951	-	-

JYBU - Débroussailleuses

Companion	0,50	BM6A	5921	01	5478
R50	0,50	BM7F	6421	-	-

JYBU - Tronçonneuses

L6, L7, L8, L73, L81, L86S, L86B, L860, L86-6	0,60	BPMR6A	6726	08	5063
LF 50, 50B, LP-5, LP-5BS	0,50	BM7F	6421	-	-
LP-6, LP-6B, LP-6BV, LF50	0,70	BM7F	6421	-	-
M5	0,50	BPR6HS	7022	-	-
Micro 25, 25CVA, SL3, L35	0,70	BM6A	5921	01	5478
SL-2 / SL-3 / SL3-S / SL-31 / SL-35	0,60	BMR6F	2144	11	7683

KAAZ - Débroussailleuses

110	0,70	BMR6A	7421	01	5478
J40FD, JQ-G4K / T200 / 50, JL1-T200	0,60	BM6A	5921	01	5478
KLQ / KQP-LS	0,50	BMR6A	7421	01	5478
Mot. Kawasaki 2.1 hp	0,70	BR6S	3522	09	6048
Mot. Kawasaki KT12 1.2 hp / T130 1.3 hp	0,70	BM6A	5921	01	5478
Series J / V	0,50	BMR6A	7421	01	5478
Silver X, TM30B	0,70	BMR6A	7421	01	5478
V15 / V18 / V20 / V25 / V40	0,60	BM6A	5921	01	5478

KAAZ - Tronçonneuses

Mot. Kawasaki KT12 1.2 hp	0,60	BMR6A	7421	01	5478
Mot. Kawasaki KT15 1.3 hp / KT17 1.5 hp	0,60	BM7A	6521	10	6793
Mot. Kawasaki KT18 1.8 hp	0,60	BMR6A	7421	01	5478
Mot. Kawasaki KT30 2.1 hp	0,60	B6S	3510	09	6048
Mot. Mitsubishi T50 1.5 hp	0,60	BMR6A	7421	01	5478
Mot. Xenoah G2C / G2D 22.5 cc	0,70	BM7A	6521	10	6793
Mot. Xeno. G3C 31.7cc / G4C 37.4cc / G5C 52.5cc	0,60	BR6HS	3922	-	-

KATEX - Tronçonneuses

KAT-10 / KAT-25DAEX	0,70	BMR6A	7421	01	5478
KAT-34	0,70	BPMR6A	6726	08	5063

KATO - Tondeuses

Mot. B&S / Kohler	0,70	BR2-LM	5798	06	4740
-------------------	------	--------	------	----	------

KAWASAKI - Débroussailleuses

KBH 33A / 34A / 43A / 48A	0,60	BMR6A	7421	01	5478
KBL 23A (22.5cc) / 26A (25.4cc) / 27A (26.3cc)	0,80	BPMR6A	6726	08	5063
KBL 27B / 27BC	0,70	BPMR7A	4626	02	5959
KBL 34A Mot. 33.3cc	0,80	BPMR6A	6726	08	5063
KBL 43A, KBLH 48A	0,60	BMR6A	7421	01	5478
KCL 600A / KCS 525A - Mot. TJ27E	0,60	BPMR7A	4626	02	5959
KCS 600A / KCSL 525A - Mot. TJ27E	0,60	BPMR7A	4626	02	5959
KEL 26A / 27A - Mot. 25.4cc	0,60	BPMR6A	6726	08	5063
KEL 27B - Mot. TJ27E	0,60	BPMR7A	4626	02	5959
KGT 26AC / 37A	0,70	BPMR7A	4626	02	5959
KGT 27A Mot. 26.3cc	0,80	BPMR6A	6726	08	5063
KHD 600A & KHS 1100A - Mot. 22.5 cc	0,70	BMR4A	5728	-	-
KHD 600B & KHS 1100B - Mot. 22.5cc	0,70	BPMR6A	6726	08	5063
KHS 750A / AC - Mot. 22.5 cc	0,70	BMR4A	5728	-	-
KHS 750B - Mot. 22.5 cc	0,60	BPMR6A	6726	08	5063
KHS 750BC - Mot. 22.5 cc	0,70	BMR7A	4226	10	6793
KHT 600D / S & 750D / S - Mot. 22.5 cc	0,60	BPMR6A	6726	08	5063
KHT 600SC & 750SC - Mot. 22.5 cc	0,70	BMR7A	4226	10	6793
KTR 26AC Mot. 25.4cc, KTR 27A Mot. 26.3cc	0,80	BPMR6A	6726	08	5063
Series TD18, TD24, TD33	0,70	BMR6A	7421	01	5478

KAWASAKI - Générateurs

FA 076 D	0,70	BM6A	5921	01	5478
FA 76 (82)	0,70	BMR6A	7421	01	5478
FA 76 (83-)	0,70	BM4A	5628	-	-
FA 76 (Pour pompe à eau)	0,70	BP4HS	3611	-	-
FA 130	0,70	BMR6A	7421	01	5478
FA 130 (Pour pompe à eau)	0,70	BP4HS	3611	-	-
FA 130 D / G / R	0,70	BM6A	5921	01	5478
FA 210	0,70	BMR6A	7421	01	5478
FA 210 (82)	0,70	BM6	2027	-	-
FA 210 (83-)	0,70	BM6A	5921	01	5478
FA 210 (Pour pompe à eau)	0,70	BP4HS	3611	-	-
FA 210 D / R	0,70	BM6A	5921	01	5478
FA 210 V, FA 460	0,80	BM6A	5921	01	5478
FC 150 / 180, FC 290 / 290 V, FC 400	0,70	BPR5ES	7422	03	6854
FC 400 V	0,80	BPR5ES	7422	03	6854
FC 401	0,70	BPR5ES	7422	03	6854
FC 401 V	0,80	BPR5ES	7422	03	6854
FC 420 / 420 V, FC 540 / 540 V	0,70	BPR5ES	7422	03	6854
FD 440	0,70	BMR6A	7421	01	5478
FD 440 V	0,80	BMR6A	7421	01	5478
FD 501	0,70	BMR6A	7421	01	5478
FD 501 D	0,60	BMR6A	7421	01	5478
FD 501 V	0,80	BMR6A	7421	01	5478

Modèle	N° STOCK BLISTER STOCK BOÎTE BLISTER				Modèle	N° STOCK BLISTER STOCK BOÎTE BLISTER									
KAWASAKI - Générateurs															
FD 590	0,70	BMR6A	7421	01	5478	KG 550	0,70	B6HS	4510	-	-				
FD 611 V	0,60	BMR6A	7421	01	5478	KG 550 B	0,70	BR6HS	3922	-	-				
FD 620	0,70	BMR4A	5728	-	-	KG 600 / 700 / 750	0,70	B6HS	4510	-	-				
FD 620 D	0,80	BMR6A	7421	01	5478	KG 750 B	0,70	BR6S	3522	09	6048				
FD 661 D	0,60	BMR6A	7421	01	5478	KG 900	0,70	B6S	3510	09	6048				
FD 671 D, FD 711 D	0,70	BPR2ES	2264	-	-	KG 1000	0,70	B6S	3510	09	6048				
FD 731 V	0,70	BPR4ES	7222	-	-	KG 1100 B	0,70	BR6S	3522	09	6048				
FD 750 D	0,70	BPR2ES	2264	-	-	KG 1300 / 1500, KG 1600 (-94)	0,70	B6HS	4510	-	-				
FD 791 D	0,70	BPR4ES	7222	-	-	KG 1600 (95-), KG 1600 B	0,70	BR6HS	3922	-	-				
FD 791 DFI	0,60	BPR4ES	7222	-	-	KG 2900 A1	0,60	BMR6A	7421	01	5478				
FD 851 D	0,70	BPR4ES	7222	-	-	KG 3200	0,70	BP5HS	4111	-	-				
FE 120	0,80	BPR5ES	7422	03	6854	KG 4000, KG 4000 A / AS	0,70	BR6HS	3922	-	-				
FE 161	0,80	BP5ES	6511	03	6854	KG 5000 (84-), KG 5000 A / AS / B	0,70	BR4HS	3322	-	-				
FE 170	0,80	BPR5ES	7422	03	6854	KG 5000 BS (83-)	0,70	BR4HS	3322	-	-				
FE 170 DD	0,80	BMR6A	7421	01	5478	KGA 1800 A1	0,60	BP5HS	4111	-	-				
FE 221	0,80	BP5ES	6511	03	6854	KRB 400A	0,50	BPMR7A	4626	02	5959				
FE 250	0,80	BPR5ES	7422	03	6854	KT 10 / 12	0,70	BM6A	5921	01	5478				
FE 250 D	0,80	BMR6A	7421	01	5478	KT 12 (TZ022D)	0,70	BM7	6321	-	-				
FE 290 / 350	0,80	BPR5ES	7422	03	6854	KT 12 AD	0,70	BMR6A	7421	01	5478				
FE 400 D	0,60	BPR5ES	7422	03	6854	KT 12 D	0,70	BM7	6321	-	-				
FEX 91	0,80	BP5ES	6511	03	6854	KT 15	0,70	BMR6A	7421	01	5478				
FG 110	0,70	BP4HS	3611	-	-	KT 15 D	0,70	BM7	6321	-	-				
FG 150	0,70	BPR4HS	7823	-	-	KT 15 J	0,70	B6S	3510	09	6048				
FG 150 G, FG 200 / G / R, FG 201 / 230 / 270	0,70	BP4HS	3611	-	-	KT 17 (TZ031J)	0,70	BM7	6321	-	-				
FG 300 / 300 D	0,70	BP4HS	3611	-	-	KT 17 J	0,70	BM7A	6521	10	6793				
FH 381 V	0,60	BPMR6A	6726	08	5063	KT 18	0,80	BM6A	5921	01	5478				
FH 411 V	0,70	BPMR6A	6726	08	5063	KT 18 J (-82)	0,70	B6S	3510	09	6048				
FH 430 V	0,60	BPMR6A	6726	08	5063	KT 18 J (83-)	0,70	B-4	3210	-	-				
FH 451 V / 480 V / 500 V / 541 V / 580 V	0,70	BPMR6A	6726	08	5063	KT 28 (-82)	0,70	B6S	3510	09	6048				
FH 601 D	0,70	BPR4ES	7222	-	-	KT 28 (83-)	0,70	B-4	3210	-	-				
FH 601 V	0,90	BPR5ES	7422	03	6854	KT 29	0,70	B6HS	4510	-	-				
FH 641 D	0,70	BPR4ES	7222	-	-	KT 30 J	0,70	B6S	3510	09	6048				
FH 641 V / 661 V	0,90	BPR5ES	7422	03	6854	KT 33	0,70	B6HS	4510	-	-				
FH 680 D	0,70	BPR4ES	7222	-	-	KT 35	0,70	B6S	3510	09	6048				
FH 680 V	0,90	BPR5ES	7422	03	6854	KT 43	0,70	B6HS	4510	-	-				
FH 721 D	0,70	BPR4ES	7222	-	-	KWN 10 A (Pompe à eau)	0,60	BMR7A	4226	10	6793				
FH 721 V	0,60	BPR4ES	7222	-	-	KWN 15 A (Pompe à eau)	0,70	BMR6A	7421	01	5478				
FH 741 D	0,60	BPR5ES	7422	03	6854	KWN 20 A / 30 A, KWT 20 A (Pompe à eau)	0,80	BPR5ES	7422	03	6854				
FH 770 D	0,70	BPR4ES	7222	-	-	Power Partner (PP) 4000, 6000	0,90	BPR5ES	7422	03	6854				
FJ 100 D	0,70	BR6HS	3922	-	-	PP 4000 250 cc 4KW 1 Cyl. OHV	0,60	BPR5ES	7422	03	6854				
FJ 180V	0,90	BPR5ES	7422	03	6854	PP 6000 352 cc 6KW 1 Cyl. OHV	0,60	BPR5ES	7422	03	6854				
FR 541 V / 600 V / 651 V / 691 V / 730 V	0,70	BPR4ES	7222	-	-	TA 22	0,70	BM7	6321	-	-				
FS 481 V / 541 V / 600 V / 651 V / 691 V / 730 V	0,70	BPR4ES	7222	-	-	TA 22 MX	0,70	BMR6A	7421	01	5478				
FX 651 V / 691 V / 730 V / 751 V / 801 V / 850 V	0,70	BPR4ES	7222	-	-	TA 24	0,70	BM7	6321	-	-				
FX 921 V / 1000 V	0,70	BPR5ES	7422	03	6854	TA 36	0,70	B7S	3710	-	-				
G 1800 A, G 3200 A / AS	0,70	BPR4HS	7823	-	-	TA 36 MX	0,80	B6S	3510	09	6048				
GA 550 1 Cyl. F/C 76 cc, GA 550 A	0,70	BMR6A	7421	01	5478	TA 40 (-82)	0,70	B7S	3710	-	-				
GA 1000 / 1400 1 Cyl. F/C 129 cc	0,70	BR6S	3522	09	6048	TA 40 (83-)	0,70	BM7	6321	-	-				
GA 1000 A / 1400 A	0,70	BMR6A	7421	01	5478	TA 51 MX	0,70	BMR6A	7421	01	5478				
GA 1800 / 1800 A	0,70	BPR4HS	7823	-	-	TD 018 D / 024 D / 033 D / 040 D / 048 D	0,70	BM6A	5921	01	5478				
GA 2300 (-83)	0,80	B6S	3510	09	6048	TD 18	0,70	BMR6A	7421	01	5478				
GA 2300 (84-), GA 2300 A, GA 3200, GA 3200 A/S	0,70	BPR4HS	7823	-	-	TD 24 / 33 / 40 / 51 (-82)	0,70	BM7	6321	-	-				
GB 2300 A	0,80	BPR4HS	7823	-	-	TD 24 / 33 / 40 / 51 (83-), TD 48	0,70	BM6A	5921	01	5478				
GC 550 A, GD 550 / 550 A	0,70	BMR6A	7421	01	5478	TE 27 / 35 / 40 / 48 / 56	0,70	BM7A	6521	10	6793				
GD 700 1 Cyl. F/C 76 cc, GD 700 A / AS	0,60	BMR6A	7421	01	5478	TE 59, TEX 45	0,60	BPM7A	7321	02	5959				
GE 2200 1 Cyl. OHV 4 tps 286 cc, GE 2200 A	0,70	BPR5ES	7422	03	6854	TF 22	0,70	BM7A	6521	10	6793				
GE 2200 A1	0,90	BPR5ES	7422	03	6854	TF 22 D	0,70	BM4A	5628	-	-				
GE 2900 1 Cyl. OHV 4 tps 286 cc, GE 2900 A	0,70	BPR5ES	7422	03	6854	TF 24 / 33	0,70	BM7A	6521	10	6793				
GE 2900 A1	0,90	BPR5ES	7422	03	6854	TG 18 / 20 / 24	0,70	BMR6A	7421	01	5478				
GE 4000 1 Cyl. OHV 4 tps 397 cc	0,70	BPR5ES	7422	03	6854	TG 25	0,70	BM6A	5921	01	5478				
GE 4300 1 Cyl. OHV 4 tps 286 cc, GE 4300 A	0,70	BPR5ES	7422	03	6854	TG 28 / 33	0,70	BMR6A	7421	01	5478				
GE 4300 A1	0,90	BPR5ES	7422	03	6854	TGX 23	0,70	BM6A	5921	01	5478				
GE 4500 1 Cyl. OHV 4 tps 397 cc, GE 4500 A/AS	0,70	BPR5ES	7422	03	6854	TH 34	0,70	BPMR6A	6726	08	5063				
GE 5000 1 Cyl. OHV 4 tps 286 cc, GE 5000 AS	0,70	BPR5ES	7422	03	6854	TH 43 / 48	0,70	BM6A	5921	01	5478				
KF 24	0,70	B6HS	4510	-	-	TS 22	0,70	BMR6A	7421	01	5478				
KF 34	0,70	BMR6A	7421	01	5478	KAWASAKI - Outils Divers									
KF 53 / 53 A	0,70	B6HS	4510	-	-	KEL 26 A	0,60	BPMR6A	6726	08	5063				
KF 68 / 81	0,70	BMR6A	7421	01	5478	KHD 600 A	0,70	BMR4A	5728	-	-				
KF 82	0,70	B6HS	4510	-	-	KHD 600 B	0,60	BPMR6A	6726	08	5063				
KF 100	0,70	BR4HS	3322	-	-	KHS 750 A	0,70	BMR4A	5728	-	-				
KF 100 D (FZ400D)	0,70	B-4H	4110	-	-	KHS 750 B, KHT 600 D / 750 D	0,60	BPMR6A	6726	08	5063				
KF 140	0,70	B-4	3210	-	-	KRB 400 A / B	0,50	BPMR7A	4626	02	5959				
KF 150, KF 150 D (FZ580D)	0,70	B-4H	4110	-	-	KRB 750B - Mot. TJ27E	0,60	BPMR7A	4626	02	5959				
KF 200, KF 200 D (FZ790D)	0,70	B-4H	4110	-	-										
KG 500, KG 5000 (-83)	0,70	BM6A	5921	01	5478										

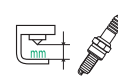
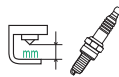

KEE - Tondeuses

Mot. B&S 5 hp	0,60	B2-LM	1147	06	4740
Mot. B&S 6 hp	0,70	BR2-LM	5798	06	4740
Mot. B&S 6.75 hp	0,70	BKR5ES	2460	07	4803
Mot. B&S 8 hp	0,60	B2-LM	1147	06	4740
Mot. B&S 16 / 20hp	0,70	BKR5ES	2460	07	4803
Mot. B&S Intek IC 10 hp	0,70	BKR5ES	2460	07	4803
Mot. Honda GV400 11 hp	0,60	BM6A	5921	01	5478
Mot. Kawasaki 12.5 hp	0,60	BM4A	5628	-	-
Mot. Kawasaki 14 hp	0,70	BP4ES	6928	-	-
Mot. Kohler 18 / 20 hp	0,70	BKR5ES	2460	07	4803
Mot. Kohler OHV 14 hp	1,10	BKR5ES-112382	-	-	-

KEM EQUIPMENT - Manutention

430 Mot. 181 ci.	0,90	UR4	6630	-	-
643 Mot. 262 ci., 857 Mot. 350 ci., 874 Mot. 454 ci.	1,00	TR5IX	7397	-	-

KING O'LAWN - Tondeuses

Tous modèles	0,70	BR2-LM	5798	06	4740
--------------	------	--------	------	----	------

KING O'LAWN - Tronçonneuses

Mark II	0,60	BMR6A	7421	01	5478
---------	------	-------	------	----	------

KINGFISHER - Tondeuses

Rotovac 18" Mot. B&S	0,70	BR6S	3522	09	6048
Rotovac 18" Mot. Iron Horse (C&D)	0,60	B-4	3210	-	-
Rotovac 18" Mot. Iron Horse (F)	0,90	BMR4A	5728	-	-
Rotovac 18" Mot. Tecumseh, Turbo Cut Mot. B&S	0,70	BR6S	3522	09	6048

KIPOR - Générateurs

IG1000 1 Cyl. 4Tps OHV (Refr. Air) 1.3 hp	0,70	CR6HSA	2983	-	-
IG2000 1 Cyl. 4Tps OHV (Refr. Air) 2.2 hp	0,70	CR6HSA	2983	-	-
IG3000 / IG3000E 1 Cyl. 4Tps OHV (Refr. Air) 4 hp	0,90	BPR6ES	7822	04	7678
IG6000 / IG6000E 1 Cyl. 4Tps OHV (Refr. Air) 7.7hp	0,90	BPR6ES	7822	04	7678
KGE1000TI 1.3 hp, KGE2000TI 2.2 hp	0,70	CR6HSA	2983	-	-
KGE2400X 1 Cyl. 4Tps OHV (Refr. Air) 4hp	0,90	BPR6ES	7822	04	7678
KGE3000TI 1 Cyl. 4Tps OHV (Refr. Air) 4hp	0,90	BPR6ES	7822	04	7678
KGE5500E 1 Cyl. 4Tps OHV (Refr. Air) 7.7hp	0,90	BPR6ES	7822	04	7678

KLEEN KUT - Tondeuses

Tous modèles	0,70	BR2-LM	5798	06	4740
--------------	------	--------	------	----	------

K-MART - Tondeuses

Tous modèles	0,70	BR2-LM	5798	06	4740
--------------	------	--------	------	----	------

KNIGHT - Tronçonneuses

Culasse Ø14 mm	0,60	B6S	3510	09	6048
Culasse Ø18 mm	0,60	AB-6	2910	-	-

KOHLER - Générateurs

1.75 MBFM	0,60	BMR6A	7421	01	5478
1.75 MBM 25, 1.75 MFM, 1.75 MM 25	0,60	BR6S	3522	09	6048
2.225 MBM 25, 2.25 MBFM 25, 2.25 MBFM 45	0,60	BMR6A	7421	01	5478
2.5 MV 55 K 160 7 hp, 2.5 MV 55 K 161 7 hp	0,60	BR6S	3522	09	6048
3 MMV 55	0,60	BR6S	3522	09	6048
3.5 MBFM 45/65, 3.5 MBM 25/65	0,60	BMR6A	7421	01	5478
3.5 MFM 45, 3.5 MFM 65, 3.5 MM 25, 3.5 MM 65	0,60	BR6S	3522	09	6048
4 A 23	0,60	B6S	3510	09	6048
4 CM 21 4 kW, 5 CMK 21 5 kW	0,70	B-6L	3212	-	-
5 MBM 25, 5 MBM 65	0,60	BMR6A	7421	01	5478
5 MFM45	0,60	BR6S	3522	09	6048
5 MM 25, 5 MM 65	0,70	B-6L	3212	-	-
7.5 A 23, 25 R 81 25kW, 3 MM 25 3 Kw	0,60	B6S	3510	09	6048
75 R 81	0,60	AB-6	2910	-	-
B&S Ø14mm 800W	0,50	BR2-LM	5798	06	4740
B&S Ø18mm 800W	0,60	WR5	2438	-	-
CH 5	0,70	BCPR5ES	6130	07	4803
CH 5 Command OHV Horizontal Twin	1,10	BKR5E-11	6953	-	-
CH 6 / 11 / 12.5 / 13 / 14 / 15	1,00	BKR5ES	2460	07	4803
CH 16 / 18 / 20	0,70	BKR5ES	2460	07	4803

CH 22	0,70	BCPR5ES	6130	07	4803
CH 22 Command OHV Horizontal Twin	0,70	BKR5E	7938	07	4803
CH 23	0,70	BKR5ES	2460	07	4803
CH 25	0,70	BCPR5ES	6130	07	4803
CH 25 Command OHV Horizontal Twin	0,70	BKR5E	7938	07	4803
CH 26	0,70	BKR5ES	2460	07	4803
CH 27 Command OHV Horizontal Twin	0,70	BKR5E	7938	07	4803
CH 270 / 395	0,70	BKR5ES	2460	07	4803
CH 410 / 430	1,00	BKR5ES	2460	07	4803
CH 440	0,70	BKR5ES	2460	07	4803
CH 450	1,00	BKR5ES	2460	07	4803
CH 620 / 640 / 680 / 730 / 735 / 740 / 745 / 750	0,70	BKR5ES	2460	07	4803
CS 4/6/8 Command Pro CS Series Horizontal Shaft	0,70	BPR4ES	7222	-	-
CS 8.5, CS 12.75	0,70	BPR4ES	7222	-	-
CS 10/12 Command Pro CS Series Horizontal Shaft	0,70	BPR4ES	7222	-	-
CS 13 Command Pro CS Series Horizontal Shaft	0,70	BPR4ES	7222	-	-
CS 13 Hydri CommandPro Horizontal Shaft	0,70	BPR4ES	7222	-	-
CV 11 / 12.5 / 13 / 14 / 15	1,00	BKR5ES	2460	07	4803
CV 16 / 17 / 18 / 20 / 22 / 23	0,70	BKR5ES	2460	07	4803
CV 25 Command OHV Vertical Twin	0,70	BKR5E	7938	07	4803
CV 26	0,70	BKR5ES	2460	07	4803
CV 460 / 490 / 491 / 492 / 493	1,00	BKR5ES	2460	07	4803
CV 620 / 640 / 675 / 680 / 730 / 735 / 740 / 745	0,70	BKR5ES	2460	07	4803
CV 750	0,70	BKR5ES	2460	07	4803
Daihatsu FE	0,80	BP5ES	6511	03	6854
ECH & ECV 630 / 650 / 680 / 730 / 740 / 749	0,70	BKR5ES	2460	07	4803
FC Culasse Ø18mm 5 / 10kW	0,60	AB-6	2910	-	-
GS 300 5.5 hp	1,00	BPR4HS-10	5024	-	-
Honda 3.5CFZ, 4CZ, 5CFZ, 6.5CZ 13 hp	0,60	BPR6HS	7022	-	-
K 7 4 hp	0,60	B-2	3110	-	-
K 12 4 hp 750W	0,60	BR6S	3522	09	6048
K 12 8 hp	0,60	B-2	3110	-	-
K 90/91 4 hp 500W, K 90/91 4 hp 1.5 kW	0,60	B6S	3510	09	6048
K 101 4 hp	0,60	B6S	3510	09	6048
K 160 / K 161 7 hp (1 / 2.5 kW), K 181 8 hp 2.5 kW	0,60	B6S	3510	09	6048
K 241 10 hp 2 / 3.5 / 5 kW	0,70	B-6L	3212	-	-
K 301 12 hp	0,90	B-6L	3212	-	-
K 321 14 hp	0,60	B-6L	3212	-	-
K 330 12.5 hp 1.5 / 3.5 kW	0,60	B6S	3510	09	6048
K 330 12.5hp	0,70	BR2-LM	5798	06	4740
K 330 14 hp	0,60	B6S	3510	09	6048
K 330 15.5hp 1.5 / 3.5 kW	0,60	B6S	3510	09	6048
K 331 12.5 hp 1.5 / 3.5 kW	0,60	B6S	3510	09	6048
K 331 14 hp, K 331 15.5hp 1.5 / 3.5 kW	0,60	B6S	3510	09	6048
K 341 16 hp	0,60	B-6L	3212	-	-
K 361 18 hp	0,90	B-6L	3212	-	-
K 482 / 532 / 582	0,60	B-6L	3212	-	-
K 662 24 hp 5 / 6.5 kW, K 7 2.7 hp 350W	0,60	BR6S	3522	09	6048
Kawa. 4EF, 5E, 6EF, 7.3E 13 hp	0,60	BM4A	5628	-	-
KL 25 25hp	0,60	BPR6ES	7822	04	7678
KT 17 / 19	0,70	BPR4FS	1127	-	-
KT 20 (Twin) 20hp	0,60	BPR4FS	1127	-	-
L 160 / 161	0,60	B6S	3510	09	6048
L 600 2 / 3.5 / 5 kW, L 654 1.5kW	0,60	BR6S	3522	09	6048
LH 630 / 640 / 685 / 690 / 755 / 775	0,70	BKR5ES	2460	07	4803
LV 625 / 675 / 680	0,70	BKR5ES	2460	07	4803
M 8	0,70	BMR6A	7421	01	5478
M 8 Magnum Horizontal Twin	0,60	B-6L	3212	-	-
M 10 / 12 / 14 / 16	0,70	B-6L	3212	-	-
M 18 / 20	0,70	BPR4FS	1127	-	-
M 18 / 20 Magnum Horizontal Twin	0,60	B-6L	3212	-	-
MM 25 1.5 / 3 kW	0,60	BR6S	3522	09	6048
MV 16 / 18 / 20	0,70	BPR4FS	1127	-	-
SH 265	0,70	BKR5ES	2460	07	4803
SV 470 / 480 / 530 / 540 / 590 / 600 / 610 / 620	0,70	BKR5ES	2460	07	4803
SV 710 / 715 / 720 / 725 / 730 / 735 / 740	0,70	BKR5ES	2460	07	4803
TH 14 / TH 16 / TH 18 (Twin) Triad OHC	1,10	BKR5E-11	6953	-	-
TH 520 / 575 / 650	0,70	BKR5ES	2460	07	4803
Waukesha 180 GLB 10 kW	0,60	AB-6	2910	-	-
Waukesha 185 GLB 15 kW	0,60	AB-6	2910	-	-
Waukesha 195 GL 35 kW, Wisconsin VH4D	0,60	AB-6	2910	-	-
XT-7, XTR-7	0,70	BKR5ES	2460	07	4803

KOMATSU - Manutention

FG Series	0,60	B5ES	6410	-	-
Mitsubishi Gaz	0,90	FR2A-D	4768	-	-

Modèle

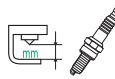
 N° STOCK BLISTER
 N° BOÎTE
 N° BLISTER

KOMATSU ZENOAH - Tronçonneuses

G300AV, G300AVS, G300T, G300TS	0,60	BPM6A	7021	08	5063
G320AV, G320AVS, G380AV, G380AVS	0,60	BPM6A	7021	08	5063
G400AVS, G450AVS, G560AV, G560AVS	0,60	BPMR6A	6726	08	5063
G561AVS, G561AVSH, G620AV, G620AVS	0,60	BPMR6A	6726	08	5063
G621AVS / G621AVSH	0,60	BPM7A	7321	02	5959

KREIS - Tronçonneuses

J1-110AV / J1-170AV	0,60	BPM7A	7321	02	5959
MS-107	0,70	B7S	3710	-	-

KUBOTA - Générateurs

A 350 / 400 / 500 - GN550	0,60	BM4A	5628	-	-
A 650 - GS130	1,00	BP4HS-10	5011	-	-
A 800 / 1000 / 1200 / 1400 - GS130	0,60	BP4HS	3611	-	-
A 1500 / 1800 - GN1850, A 2000 / 2100 - GN2500	1,00	BP4HS-10	5011	-	-
A 2400 - GS280	0,60	BP4HS	3611	-	-
A 2500 / 3000 - GN2500	1,00	BP4HS-10	5011	-	-
A 3050 / 3500 - GS280	0,60	BP4HS	3611	-	-
AE 1100 / 1500 - GS130	0,60	BPR4HS	7823	-	-
AE 2200 - GS200, AE 3200 / 3500 - GS280	0,60	BPR4HS	7823	-	-
AE 4500 - GH280	0,60	BPR6HS	7022	-	-
AE 5500 - GH400, AE 6500 - GH400	1,00	BPR4HS-10	5024	-	-
AT 25 - GS90V, AT 55 - GA200, AT 70 S - GS280	0,70	BR4HS	3322	-	-
AV 650 - GS90	0,70	BMR4A	5728	-	-
AV 1600 - GH120, AV 2500 - GH170	0,60	BPR6HS	7022	-	-
AV 3800 - GH250, AV 4500 - GH280	0,60	BPR6HS	7022	-	-
AV 5500 - GH400	1,00	BPR4HS-10	5024	-	-
AV 6500 - GH400	1,00	BPR4HS-10	5024	-	-
FRT 50 - GS200, FRT 70 - GS280	0,70	B-4H	4110	-	-
GH 120 2.8 hp	0,70	BP6HS	4511	-	-
GH 150 V 5 hp	0,70	BR5ES	4722	-	-
GH 170 4.3 hp, GH 250 6 hp	0,70	BP6HS	4511	-	-
GH 340 8 hp	0,70	BP6ES	7811	04	7678
GH 400	1,00	BPR4HS-10	5024	-	-
GH 400 V 10 hp, GS 130 2.3 hp	0,70	BPR4HS-10	5024	-	-
GS 160 2.8 hp, GS 200 3.8 hp	0,70	BP5ES	6511	03	6854
GS 300 5.5 hp	0,70	BPR4HS-10	5024	-	-
GZ 410 (2000-)	0,70	BKR4E-11	5424	-	-
HE 20 - GN100	0,60	B-4H	4110	-	-
HE 22 A - GS120	1,00	BP4HS-10	5011	-	-
HE 30 - GN145, HE 50 - GN185	1,00	B-4H-10	4010	-	-
HF 20 - GS130	0,60	BP6HS	4511	-	-
HF 32 - GS150, HF 52 - GS170	1,00	BP4HS-10	5011	-	-
HH 400 - GN185	1,00	B-4H-10	4010	-	-
HH 500 - GN250	0,60	B-4H	4110	-	-
HI 302 - GS200	1,00	BP4HS-10	5011	-	-
HS5 / HS6 - GS230-2Mi	1,00	BPR4HS-10	5024	-	-
NA 1500 / 1900 - GS200	0,70	BPR4HS	7823	-	-
NA 2000 - GS280, NA 2200 - GS200	0,70	BPR4HS	7823	-	-
NA 2400 / 2500 / 2600 / 3000 / 3050 - GS280	0,70	BPR4HS	7823	-	-
NA 3200 / 3500 - GS280	0,70	BPR4HS	7823	-	-
NA 400 / 500 / 510 / 600 - GS90	0,70	BMR4A	5728	-	-
NX 250 - GN250	0,60	B-4H	4110	-	-
NX 350 - G2900	1,00	B-4H-10	4010	-	-
RH 400 - GS230, RH 500 - GS280	1,00	BP4HS-10	5011	-	-
T 2 - GN100	0,60	B-4H	4110	-	-
T 3 / T 4 - GN145	1,00	B-4H-10	4010	-	-
T 5 / T 6 / T 7 - GN250	0,60	B-4H	4110	-	-
T 150 / T 250 / T 350 - GS130, T 400 - GS160	1,00	BP4HS-10	5011	-	-
T 402 - GS230	0,70	B-4H	4110	-	-
T 420 - GN145	1,00	B-4H-10	4010	-	-
T 450 / T 550 - GS160	1,00	BP4HS-10	5011	-	-
T 602 - GS280	0,70	B-4H	4110	-	-
T 620 - GN185	1,00	B-4H-10	4010	-	-
T 650 / 720 / 750 - GN250, T 702 / 850 - GS280	0,60	B-4H	4110	-	-
TF 35 - GS150, TF 45 / TF 55 - GS110	1,00	BPR4HS-10	5024	-	-
TG 600 - GH170, TG 800-R - GH250	0,60	BP6HS	4511	-	-
TMA 31 - GS130	1,00	BP4HS-10	5011	-	-
TX 100 - GS90	0,70	BP5HS	4111	-	-
TX 120 - GS120, TX 300 - GS150, TX 400 - GS160	1,00	BP4HS-10	5011	-	-
TX 500 - GS200, TX 600 - GS230	0,70	B-4H	4110	-	-
TX 700 - GS280, TX 900 - GS330	0,70	B-4H	4110	-	-
WG 750	1,10	BKR4E-11	5424	-	-

Modèle

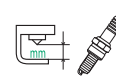
 N° STOCK BLISTER
 N° BOÎTE
 N° BLISTER

KUBOTA - Manutention

AT25 Mot. GS90V, AT55 Mot. GA200	0,70	BR4HS	3322	-	-
AT70S Mot. GS280	0,70	BR4HS	3322	-	-
H1302 Mot. GS200	1,00	BP4HS-10	5011	-	-
HE20 Mot. GN100	0,60	B-4H	4110	-	-
HE22A Mot. GS120	1,00	BP4HS-10	5011	-	-
HF20 Mot. GS130	0,60	BP6HS	4511	-	-
HF32 Mot. GS150, HF52 Mot. GS170	1,00	BP4HS-10	5011	-	-
HH500 Mot. GN250	0,60	B-4H	4110	-	-
HS5, HS6 Mot. GS230-2Mi	1,00	BPR4HS-10	5024	-	-
RH400 Mot. GS230, RH500 Mot. GS280	1,00	BP4HS-10	5011	-	-

KUBOTA - Tondeuses

GH 150 V-LT	0,80	BR5ES	4722	-	-
Mot. Honda OHV 5 hp	0,80	BPR6ES	7822	04	7678
Mot. Kohler 19 hp	0,70	UR4	6630	-	-
T1400H	0,70	BPR6HS	7022	-	-
W5019 / W5021 (->1989)	0,80	BR5ES	4722	-	-
W5019, W5021 (1990->)	0,80	BPR2ES	2264	-	-
ZG222, ZG227, ZG327 Mot. KGZ770	0,70	BPR6HS	7022	-	-

KUT-KWICK - Tondeuses

Mot. B&S	0,70	BR2-LM	5798	06	4740
Mot. Kohler	0,80	B-6L	3212	-	-
Mot. Kohler V-Twin 23 hp	0,80	BKR5E	7938	07	4803
Mot. Onan Twin 20 / 24 hp	1,00	TR4	3754	-	-
Mot. Wisconsin	0,80	AB-6	2910	-	-

KUT-KWICK - Tronçonneuses

Culasse Ø14 mm	0,60	B6S	3510	09	6048
Culasse Ø18 mm	0,60	AB-6	2910	-	-

KWICK-TOTER - Manutention

Tous modèles	0,60	AB-6	2910	-	-
--------------	------	------	------	---	---

KYNAST - Tondeuses

Mot. B&S	0,60	B4-LM	3410	05	4358
Mot. F&S	0,60	B-4H	4110	-	-

LANCASTER - Tronçonneuses

50 / IL / HL, 60HL	0,60	BMR6A	7421	01	5478
200A, 325, 350 / A/B, 400 B/S, 425, 440, 447, 450	0,80	BR6S	3522	09	6048
500 / 600	0,70	B-4L	3112	-	-
540 / 547 / 550	0,80	BR6S	3522	09	6048
555 / 560	0,60	BMR6A	7421	01	5478
558 / 650 / 658	0,80	BR6S	3522	09	6048
600HL / 700HL	0,60	BMR6A	7421	01	5478
645 / 655 / 670	0,80	BR6S	3522	09	6048
3550	0,80	B6S	3510	09	6048
Eight-20 / Six-10	0,80	BR7HS	4122	-	-
Mini Auto, Mini-12, SLA/20	0,60	BMR6A	7421	01	5478

LANDMARK - Tondeuses

Mot. B&S	0,70	BR2-LM	5798	06	4740
Mot. Tecumseh	0,70	BR4-LM	4133	05	4358

LANDMASTER - Tondeuses

Stoic, Saturn Mot. B&S	0,70	BR2-LM	5798	06	4740
------------------------	------	--------	------	----	------

LANDONI - Débroussailleuses

LF30CF/CL/ST, LF36S/ST, LF38S	0,70	BPMR7A	4626	02	5959
-------------------------------	------	--------	------	----	------

LANDONI - Tronçonneuses

L40	0,60	BMR6A	7421	01	5478
L48 E/S, L771 E/S, L772 E/L/S	0,60	BPMR6A	6726	08	5063
L75 / L773	0,60	BMR6F	2144	11	7683
L98 / 110	0,60	BR7HS	4122	-	-
LF30 CL / LF36S	0,60	BPM6A	7021	08	5063

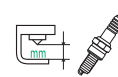
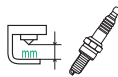

LAWN CAD 2000 - Tondeuses

Mot. B&S V-Twin Vanguard 16 hp	0,90	BKR5E	7938	07	4803
--------------------------------	------	-------	------	----	------

LAWN CHIEF - Tondeuses

Mot. B&S 3.5 / 3.75 / 4 / 5 hp	0,70	BR2-LM	5798	06	4740
--------------------------------	------	--------	------	----	------

LAWN CRUISER - Tondeuses

Tous modèles	0,70	BR2-LM	5798	06	4740
--------------	------	--------	------	----	------

LAWN FLITE - Tondeuses

Mot. B&S	0,70	BR2-LM	5798	06	4740
Mot. Lauson / Power Product	0,70	BR6S	3522	09	6048
Tous autres modèles	0,70	BM6A	5921	01	5478

LAWN MASTER - Tondeuses

18" Rotary 92900 Mot. B&S 3.5 hp	0,80	B6S	3510	09	6048
18" Rotary Johnson 2 tps Iron Horse D401/500	0,60	B-2	3110	-	-
19" Rotary 500 Contractor Mot. Kawa. KF34D	0,80	B6S	3510	09	6048
19" Rotary Mot. B&S 3.5 hp	0,60	BMR6A	7421	01	5478
19" Rotary Mot. B&S 350/400 60102 2 hp	0,80	B6S	3510	09	6048
19" Rotary Mot. B&S 480 3.5 hp	0,60	BMR6A	7421	01	5478
19" Rotary Mot. B&S 480.4 110900	0,60	BMR6A	7421	01	5478
19" Rotary Mot. B&S 500 80202/80302 3 hp	0,80	B6S	3510	09	6048
19" Rotary Mot. Iron Horse F serie 480.2F	0,70	BMR4A	5728	-	-
500 Golf 600 Mot. Kawasaki 34D 3.5 hp	0,80	B6S	3510	09	6048
500 Golf Mot. B&S 100202 4 hp	0,80	B6S	3510	09	6048
500 Golf Mot. Tec. TSV 661 2 Ventil 3.5hp	0,80	B6S	3510	09	6048
Reel&Rotarymowers Mot. B&S	0,70	B2-LM	1147	06	4740
Reel&Rotarymowers Tecumseh	0,60	B2-LM	1147	06	4740
V.I.C. Spezial Mot. B&S 3.5 hp	0,60	BMR6A	7421	01	5478

LAWN ROV'R - Tondeuses

Mot. B&S	0,70	BR2-LM	5798	06	4740
Mot. B&S Twin, Mot. Tecumseh	0,70	BR6S	3522	09	6048

LAWN-BOY - Débroussailleuses

Gold / Silver - Mot. 127cc	0,70	BR6S	3522	09	6048
Mot. B&S	0,70	B2-LM	1147	06	4740
Mot. Piston Power	0,50	BM6F	6221	11	7683
Mot. Tecumseh	0,70	BR6S	3522	09	6048
Silver - Series Mot. 127cc	0,90	BR6S	3522	09	6048
Tous les autres modèles	0,60	BM6A	5921	01	5478

LAWNBOY - Tondeuses

10 630 / 632 Mot. B&S OHV 140cc	0,50	BKR5ES	2460	07	4803
10 682 / 683 / 684 / 685 Mot. Tecumseh 195cc	0,70	BR2-LM	5798	06	4740
10 686 / 687 Mot. Tecumseh 195cc	0,70	BR2-LM	5798	06	4740
10 694 / 695 / 696 / 697 Mot. Honda GCV160 5hp	0,80	BPR6ES	7822	04	7678
10 780 / 785 Mot. Tecumseh 195cc	0,70	BR2-LM	5798	06	4740
10 795 / 796 / 797 Mot. Honda GCV160 5hp	0,80	BPR6ES	7822	04	7678
22270 Mot. Honda GSV190 190cc	0,90	BPR5ES-11	4424	-	-
4535 / CT, 8290	0,70	BR6S	3522	09	6048
Démarrateur Electrique	0,90	BM4A	5628	-	-
Démarrateur Standard	0,60	BM4A	5628	-	-
GoldPro Series - Mot. 2 tps	0,90	BM4A	5628	-	-
GoldPro Series - Mot. 2 tps 6.5 hp	0,70	BPMR6A	6726	08	5063
Mot. O.M.C. (de 09.76 à ...)	0,80	B-4	3210	-	-
Mot. O.M.C. (jusqu'à 09.76)	0,70	BMR4A	5728	-	-
Silver Pro Series - Mot. 2 tps 6.5 hp	0,60	BM4A	5628	-	-
Silver Series - Mot. 4 tps	0,70	BR2-LM	5798	06	4740
Zero-Turn Z210 / 230 Mot B&S Intek	0,80	BKR5E	7938	07	4803
Zero-Turn Z320 Mot. Honda GXV 530	0,80	BPR5ES	7422	03	6854
Zero-Turn Z340 / 350 Mot. Honda GXV530	0,80	BPR5ES	7422	03	6854

LAWNCRAFT - Tondeuses

Tous modèles	0,70	BR2-LM	5798	06	4740
--------------	------	--------	------	----	------

LAWN-CYCLE - Tondeuses

Tous modèles	0,70	BR2-LM	5798	06	4740
--------------	------	--------	------	----	------

LAWNROWER - Tondeuses

Mot. Tecumseh	0,70	BR6S	3522	09	6048
Tous modèles	0,70	BR2-LM	5798	06	4740

LAZY BOY - Tondeuses

Tous modèles	0,70	BR2-LM	5798	06	4740
--------------	------	--------	------	----	------

LEHR - Débroussailleuses

ST025 CS / SS / DC / DS Propane	0,60	CMR6A	1223	-	-
---------------------------------	------	-------	------	---	---

LEOPARD - Tondeuses

Mot. Aspera, Mot. B&S	0,60	B4-LM	3410	05	4358
-----------------------	------	-------	------	----	------

LESCO EQUIPEMENT - Débroussailleuses

LHD 2400, LST 2600	0,70	BPMR7A	4626	02	5959
LHE 2475	0,60	BPMR6A	6726	08	5063

LESCO - Tondeuses

Mot. Honda OHV 5.5 hp, Mot. Kawasaki OHV 5 hp	0,80	BPR5ES	7422	03	6854
---	------	--------	------	----	------

LESCO - Tronçonneuses

LCS4500 / LCS5100	0,80	BPMR7A	4626	02	5959
-------------------	------	--------	------	----	------

LIFT DYNAMICS - Manutention

Scorpion - Mot. Ford 300 ci.	0,80	WR5	2438	-	-
------------------------------	------	-----	------	---	---

LIMA - Tondeuses

Mot. Lauson	0,70	BR2-LM	5798	06	4740
-------------	------	--------	------	----	------

LINK - Tondeuses

Flail Mower Mot. Robin 24in.	0,70	BR6HS	3922	-	-
------------------------------	------	-------	------	---	---

LITTLE WONDER - Outils Divers

2216 DE / 2224 DE / 2230 DE / 2230 SE / 2242 SE	0,60	BPM6A	7021	08	5063
9005 P / 9008 IC / 9008 P	0,50	B2-LM	1147	06	4740
9333 / 9444 E	0,60	BPM7A	7321	02	5959

LITTLE WONDER - Tondeuses

Mot. B&S	0,70	BR2-LM	5798	06	4740
Mot. Kohler	0,70	BR6S	3522	09	6048

LLOYD - Tondeuses

Ariel Mot. Honda, Paladin Mot. Honda	0,70	BR6HS	3922	-	-
Pennsylvania Mot. Honda	0,70	BR6HS	3922	-	-

LOCKE - Tondeuses

Mot. B&S Intek 6.5 hp	0,70	BKR5ES	2460	07	4803
Mot. B&S Vanguard OHV 6 hp	0,70	BR2-LM	5798	06	4740
Mot. Honda 5.5 hp	0,80	BPR6ES	7822	04	7678
Mot. Kawasaki FH721V 25 hp	0,60	BPR4ES	7222	-	-
Mot. Kohler 6 hp	1,00	BKR5ES-11	2382	-	-

LOMBARD - Tronçonneuses

3, 3A, 3-1/2, 3.5, 5, 5A, 5.5A	0,60	BMR6A	7421	01	5478
30, 34, 35, 36, 37, 68, 69, 70	0,60	BMR6A	7421	01	5478
648, 650, 658	0,80	BR6S	3522	09	6048
660	0,60	BMR6A	7421	01	5478
AL42, AL51 & Automatic	0,70	BM7A	6521	10	6793
Auto Super Lightning	0,60	BM7A	6521	10	6793
Comango	0,70	BM7A	6521	10	6793
F54, L30, L50, L55, L60, L70, L80, L90	0,60	BMR6A	7421	01	5478
Little Lightening Super Deluxe	0,80	BPM6A	7021	08	5063
Pony	0,80	BMR6F	2144	11	7683
Super AL42 / Automatic, Super AL51 / Automatic	0,70	BM7A	6521	10	6793
Super Comango / Automatic	0,70	BM7A	6521	10	6793
Super Deluxe	0,80	BPMR7A	4626	02	5959

Modèle

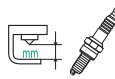
 N° STOCK BOÎTE
 N° BLISTER
 N° BLISTER

LOMBARDINI - Générateurs

LA 205 / 250 / 300 / 400 / 490 / 510, LAL 250	0,50	B-4H	4110	-	-
LAV 250, LAP 205 / 250 / 300 / 400 / 490	0,50	B-4H	4110	-	-
LGA 184, 225, 226	0,70	BPR4HS	7823	-	-
LGA 280, LGA 340	0,70	BCPR5ES	6130	07	4803
LGW 523 MPi	0,90	BCPR5ES	6130	07	4803
LGW 523, 627	0,80	BCPR5ES	6130	07	4803

LOMELLINA - Tronçonneuses

201(S, E), 202(S, E)	0,60	BM6A	5921	01	5478
203	0,60	BM6F	6221	11	7683
757	0,70	B8HS	5510	-	-
759 / 761	0,60	B6HS	4510	-	-

LONMORE - Tondeuses

Mot. Kawasaki OHV 14, 20 hp	0,80	BPR5ES	7422	03	6854
Mot. Kohler OHV 15hp	0,80	BKR5E	7938	07	4803
Mot. Tecumseh OHV 16 hp	0,80	BR7ES	5122	-	-

LULL - Manutention

800 Mot. Onan NHC	0,60	B5ES	6410	-	-
1200 - Continental Y112	0,60	AB-6	2910	-	-
T10G2, T10G4	0,60	B6S	3510	09	6048

M.H.F. WORK BULL - Manutention

202C, 204, 302, 304, 356, 404, 1001	0,60	AB-6	2910	-	-
-------------------------------------	------	------	------	---	---

MacDONALD - Manutention

Tous modèles	0,60	B6S	3510	09	6048
--------------	------	-----	------	----	------

MAG - Générateurs

1014, 1017, 1021 SRL, 1023, 1026, 1029 SRL	0,50	B-4H	4110	-	-
1035, 1040, 1045 SRL	0,50	B-4H	4110	-	-
2055 SRL	0,60	B7HS	5110	-	-
2076 SRL	0,50	B-4H	4110	-	-

MAGIC LINE - Tondeuses

Mot. B&S	0,80	B2-LM	1147	06	4740
----------	------	-------	------	----	------

MAGNUM DIAMOND - Tronçonneuses

Mot. B&S Vanguard 9 / 16 / 18 hp	0,80	BKR5ES	2460	07	4803
Mot. Honda OHV 9 / 11 / 13 hp	0,80	BPR5ES	7422	03	6854
Mot. Wisconsin 37 hp	0,60	AB-6	2910	-	-
Mot. Wisconsin 65 hp	0,60	BPR5ES	7422	03	6854

MAINLINE - Tondeuses

Mot. Acme	0,70	BR6HS	3922	-	-
Mot. B&S	0,70	BR2-LM	5798	06	4740

MAKITA - Débroussailleuses

DBC 300 / 301, DST 300 / 301 - Mot. Makita 30cc	0,70	BPMR7A	4626	02	5959
EH 561 / 760 - Mot. Robin 21.7 cc	0,70	BM7A	6521	10	6793
EM 2650LH / EM 2650UH Mot. 25.4cc	0,60	CMR4A	5474	-	-
EM 4251	0,80	BPM7A	7321	02	5959
EN 5550SH Mot. 25.4cc	0,60	CMR4A	5474	-	-
RBC 220	0,70	BM7A	6521	10	6793
RBC 221 Mot. 21.7cc Robin	0,60	BM7A	6521	10	6793
RBC 230 Mot. 22.2cc Robin	0,60	BM7A	6521	10	6793
RBC 250	0,70	BM7A	6521	10	6793
RBC 251 / 252 / 253 Mot. 24.5cc Robin	0,60	BM7A	6521	10	6793
RBC 255	0,70	BM7A	6521	10	6793
RBC 25A Mot. 24.5cc Robin	0,60	BM7A	6521	10	6793
RBC 260 / 261 Mot. 25.4cc Robin	0,60	BPM7A	7321	02	5959
RBC 310 / 311 Mot. Robin 30.5 cc	0,80	BPM7A	7321	02	5959
RBC 321	0,70	BM7A	6521	10	6793
RBC 411	0,80	BPM7A	7321	02	5959
RBC 520	0,70	BM7A	6521	10	6793
RBK 411	0,80	BPM7A	7321	02	5959

Modèle

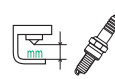
 N° STOCK BOÎTE
 N° BLISTER
 N° BLISTER

RBL 25A	0,70	BM7A	6521	10	6793
RST 250 Mot. 24.5cc Robin	0,60	BM7A	6521	10	6793

MAKITA - Générateurs

G 1200R - Mot. Robin EY15D 143cc	0,60	BR6HS	3922	-	-
G 2400R - Mot. Robin EY20D 183cc	0,60	BR6HS	3922	-	-
G 2410R - Mot. Robin EH17D 172cc	0,60	B6HS	4510	-	-
G 2800 L / R, G 3200 L	0,60	BR6HS	3922	-	-
G 3500R / 3501R - Mot. Robin EY28D 273cc	0,60	BPR6HS	7022	-	-
G 3510R / 3511R - Mot. Robin EH25D 251cc	0,60	B6HS	4510	-	-
G 4300 L	0,60	BR6HS	3922	-	-
G 5500R / 5501R - Mot. Robin EY40D 388cc	0,60	BPR4HS	7823	-	-
G 5710R / 5711R - Mot. Robin EH34D 388cc	0,60	BR6ES	4922	-	-

MAKITA - Tronçonneuses

DCS-34 Mot. 33cc	0,70	BPMR7A	4626	02	5959
DCS-330	0,70	BPMR6A	6726	08	5063
DCS-330S / 340 / 341 - Mot. Dolmar 33cc	0,50	BPMR6F	1270	-	-
DCS-390 / 400 / 401 - Mot. Dolmar 39cc	0,50	BPMR6F	1270	-	-
DCS-430 / 431 - Mot. Dolmar 43cc, DCS-43001	0,50	BPMR7A	4626	02	5959
DCS-460 / DCS-510 Mot. 49.9cc	0,70	BPMR7A	4626	02	5959
DCS-520 / 520i / 5200i - Mot. Dolmar 52cc	0,50	BPMR7A	4626	02	5959
DCS-52001 / 6000 / 68001	0,50	BPMR7A	4626	02	5959
DCS-6400 / 6401 / 6420 Mot. 64cc	0,70	BPMR7A	4626	02	5959
DCS-64200 Mot. 64cc	0,70	BPMR7A	4626	02	5959
DCS-6800i / FL / FW - Mot. Dolmar 68cc	0,50	BPMR7A	4626	02	5959
DCS-7300 / 7301 / 7900 / 7901 Mot. 64cc	0,70	BPMR7A	4626	02	5959
DCS-9000 / FL / FW - Mot. Dolmar 90cc	0,50	BPMR7A	4626	02	5959
EA3201S35B Mot. 32cc	0,60	CMR6A	1223	-	-

MANG - Tondeuses

Mot. B&S	0,70	BR2-LM	5798	06	4740
Mot. Fuji-Robin EY25W / EY44W	0,70	BR6HS	3922	-	-
Mot. Kohler K161 7 hp	0,70	BR2-LM	5798	06	4740
Mot. Wisconsin AENL	0,80	AB-6	2910	-	-

MARAUDER - Tondeuses

Mot. B&S	0,70	BR2-LM	5798	06	4740
Mot. Iron Horse	0,70	BR6S	3522	09	6048

MARK MACHINE - Débroussailleuses

1930 / 1940 / 2130	0,70	BMR6F	2144	11	7683
2800 / 2840 / 3000M / 3040M / 4000M	0,70	BMR6A	7421	01	5478

MARUYAMA - Débroussailleuses

BC 200 / 200C / 201 / 201C Mot. 19.8cc	0,60	BPMR6Y	5256	-	-
BC 200C-T / 201C-T	0,60	BPM6Y	4562	-	-
BC 2321, BC 260 / 260C / 260H Mot. 25.4cc	0,60	BPMR6Y	5256	-	-
BC 260T	0,60	BPM6Y	4562	-	-
BC 2621 / 3021	0,60	BPMR6Y	5256	-	-
BC 320 / 320C / 320H / 320T, BC 402	0,60	BPM6Y	4562	-	-
BC 402H / 402M Mot. 41.5cc	0,60	BPMR6Y	5256	-	-
BC 420 Mot. 41.5cc, BC 4200H Mot. 41.5cc	0,60	BPMR6Y	5256	-	-
BC 420H	0,60	BPM6Y	4562	-	-
BC 480M Mot. 48cc, BC 500H Mot. 50.2cc	0,60	BPMR6Y	5256	-	-
BCF 420H	0,60	BPM6Y	4562	-	-
BCGX 22 Mot. 22.2cc, BCGX 31 Mot. 31cc	0,70	CR5HSB	6535	-	-
BCX 320 Mot. 31.8cc	0,60	BPMR6Y	5256	-	-
ED 260 / 261	0,60	BPM6Y	4562	-	-
EHT 2300D Mot. 22.5cc	0,60	BPMR6Y	5256	-	-
EHT 2321D / EHT 2321DSL	0,60	BPMR6Y	5256	-	-
EHT 2600D Mot. 25.4cc	0,60	BPMR6Y	5256	-	-
Expert DP23 / 26 / 30, DG 23 / 26 / 30	0,70	BPMR8Y	2218	-	-
ExpertPro-C / THP, Expert-SA	0,70	BPMR8Y	2218	-	-
HT 159 / 159L Mot. 16cc	0,60	BPMR6Y	5256	-	-
HT 210L Mot. 21cc	0,60	BM6A	5921	01	5478
HT 220 Mot. 22cc, HT 242 / 242L Mot. 24.2cc	0,60	BPMR6Y	5256	-	-
HT 230 / 230D / 230L / 242 / 242L Mot. 22.5cc	0,60	BPMR6Y	5256	-	-
HT 250 / 250L Mot. 25cc	0,60	BM6A	5921	01	5478
HT 260D Mot. 25.4cc, HT 3221	0,60	BPMR6Y	5256	-	-
HT 2300 / 2300D / 2300L Mot. 22.5cc	0,60	BPMR6Y	5256	-	-
HT 2321D / HT 2321DLR / HT 2321DR / HT 2321L	0,60	BPMR6Y	5256	-	-

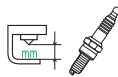

M 22 / 28 / 28F / 35 / 35D / 35F / 45 / 45D / 45F	0,60	BPM6Y	4562	-	-
MC 260 / 260C / 260S / 260E / 260D / 261	0,60	BPM6Y	4562	-	-
ML 23 H / S, MT 23 - Mot. 22.5cc	0,60	BPMR6Y	5256	-	-

MARUYAMA - Générateurs

BL 471, ED 260, MC 260/C/S/E/D	0,60	BPM6Y	4562	-	-
MC 261 / 321, MP 2520E2-B	0,60	BPM6Y	4562	-	-
MS 056/E/S, MS 057/E, MS 068	0,60	BPM6Y	4562	-	-

MARUYAMA - Tondeuses

MC 260 / C / S / E / D, MC 261	0,60	BPM6Y	4562	-	-
--------------------------------	------	--------------	-------------	---	---

MASSEY-FERGUSON - Générateurs

10-10, 20-12	0,60	BR2-LM	5798	06	4740
26, 27, 27L	0,60	B6S	3510	09	6048
30-13, 30-15, 30-17	0,60	BCPR5ES	6130	07	4803
35, 50 Clipper	0,60	AB-6	2910	-	-
60SP, 60PT, 70, 72, 80, 82, 90, 92, S.P.92 Super	0,60	B6S	3510	09	6048
Baler, Forage, Clipper S.P.Clipper	0,60	AB-6	2910	-	-
MF35, MF50, MF65, MF85, MF88, MF90	0,60	AB-6	2910	-	-
MF135 Deluxe w/ Vineyard w/Cont.Z-145	0,60	AB-6	2910	-	-
MF135 Special w/Cont. Z-134	0,60	AB-6	2910	-	-
MF150w/Cont.Z145, MF165 w/Cont.G-176	0,60	AB-6	2910	-	-
MF165, MF225 w/Perkins AG4-212, MF175, MF180	0,60	B6S	3510	09	6048
MF175-180 w/Cont.G-206, G8-206	0,60	AB-6	2910	-	-
MF230, MF235, MF245, w/Cont.Z-145	0,60	AB-6	2910	-	-
MF265 w/Perkins AG4-236	0,60	B6S	3510	09	6048
MF410 S.P.w/Chevy 292 1974-70	0,90	BPR6FS	2623	-	-
MF410 S.P.w/Chevy 292 1975	0,60	BR6FS	4323	-	-
MF510 S.P.w/Chevy 327 Engine	0,60	B6S	3510	09	6048
MF510 S.P.w/Chevy 350 1975-73	0,90	BR5FS	4123	-	-
MF1100 F-320G	0,60	AB-6	2910	-	-
MF3000 S.P.	0,60	B6ES	7310	-	-
S.P.Compickler, Swather, Windrower	0,60	AB-6	2910	-	-
TE20, TEA20, TO20, TO30, TO35	0,60	AB-6	2910	-	-

MASSEY-FERGUSON - Tondeuses

2409 - Mot. B&S 196707 8.5 hp	0,80	B2-LM	1147	06	4740
2411G - Mot. B&S 28B707 10.5 hp	0,70	BR2-LM	5798	06	4740
2411H - Mot. Kohler CV14S 14 hp	1,00	BKR5ES-11	2382	-	-
2412 - Mot. Kohler CV12.5S 12.5 hp	1,00	BKR5ES-11	2382	-	-
2414H - Mot. Kohler CV14S 14 hp	1,00	BKR5ES-11	2382	-	-
MF85	0,80	BMR6A	7421	01	5478
MF1200, MF1450, MF1650	0,80	B-6L	3212	-	-
Modèles à bras	0,70	BR2-LM	5798	06	4740
Mot. B&S 14.5 / 18 hp	0,70	BKR5ES	2460	07	4803
Mot. B&S 28B777 12.5 hp	0,80	B2-LM	1147	06	4740
Mot. B&S OHV 13 / 15 / 15.5 / 16 / 17 hp	0,70	BKR5ES	2460	07	4803
Mot. B&S Vanguard OHV 20 hp	0,70	BKR5ES	2460	07	4803
Mot. Honda GXV530 16 hp	0,80	BPR5ES	7422	03	6854
Mot. Kawasaki FD501V 17 hp (->1998)	0,80	BMR6A	7421	01	5478
Mot. Kawasaki FD750D 27 hp	0,60	BPR2ES	2264	-	-
Mot. Kawasaki V-Twin FD620D 20 hp	1,00	BMR2A-10	4452	-	-
Mot. Kohler 16 / 18 / 20 / 25 hp	0,70	BKR5ES	2460	07	4803
Mot. Kohler Command 20 / 25 hp	0,70	BKR5ES	2460	07	4803
Mot. Kohler Command V-Twin 27 hp	0,70	BKR5ES	2460	07	4803
Mot. Kohler Command V-Twin OHV 23 hp	0,70	BKR5ES	2460	07	4803
Mot. Kohler CV14S 14 hp	1,00	BKR5ES-11	2382	-	-
ZT1438 - Mot. Kohler CV14S 14 hp	1,00	BKR5ES-11	2382	-	-
ZT1644 - Mot. Kohler 16 hp	0,70	BKR5ES	2460	07	4803
ZT1850 - Mot. B&S 18 hp	0,70	BKR5ES	2460	07	4803

MASSEY-FERGUSON - Tronçonneuses

190 / A, 250	0,60	BMR6F	2144	11	7683
370 / A / AR	0,60	BMR6A	7421	01	5478

MASTER CUT - Tondeuses

Mot. B&S	0,70	BR2-LM	5798	06	4740
Mot. Tecumseh	0,70	BR6S	3522	09	6048

MASTERCRAFT - Tondeuses

Mot. B&S / Tecumseh (à bras)	0,70	BR2-LM	5798	06	4740
Mot. B&S Vanguard	0,90	BKR5E	7938	07	4803

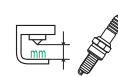

MATELEST - Tronçonneuses

MAT-101-10, MAT-101-12, MAT-106, MAT-EX	0,60	BMR6A	7421	01	5478
---	------	--------------	-------------	-----------	-------------

MAVERICK - Tondeuses

Tous modèles	0,70	BR2-LM	5798	06	4740
--------------	------	---------------	-------------	-----------	-------------

M-C - Tondeuses

Mot. B&S 10 / 16 hp	0,70	BR2-LM	5798	06	4740
Mot. B&S Vanguard 16 hp	0,80	BKR5E	7938	07	4803

McCULLOCH - Débroussailleuses

22, 28c, 29, 32, 32bcs Dlx., 32HD	0,60	BMR6F	2144	11	7683
282, 285, 287, 327, 1385L	0,60	BMR6F	2144	11	7683
2030, 2035, 2045, 2100, 2250, 2360	0,60	BPMR6F	1270	-	-
2335J	0,70	BMR6A	7421	01	5478
2380L	0,60	BMR6F	2144	11	7683
2500, 2560HD, 2565AV	0,60	BPMR6F	1270	-	-
2635B, 2635GLE	0,70	BMR6A	7421	01	5478
2816, 2816B, 2817, 2818, 2825	0,60	BMR6F	2144	11	7683
3225, 3227, 3227HD, 3227S, 3235, 3900, 4100	0,60	BMR6F	2144	11	7683
3335L, 4335B	0,70	BMR6A	7421	01	5478
BP 26AV / 30AV / 38AV, Camargue 26	0,60	BMR6F	2144	11	7683
DBC 301, DBS 300	0,70	BPMR7A	4626	02	5959
Eager Beaver 280 / 282 / 285 / 287 / 325 / 327	0,60	BMR6F	2144	11	7683
Eager Beaver I / SX / Super	0,60	BMR6F	2144	11	7683
Eager Beaver II / SL / SX	0,60	BMR6F	2144	11	7683
Eager Beaver III / SL / SX, IV / SL, GHT 17	0,60	BMR6F	2144	11	7683
GHT 2024 / 2030	0,70	BMR6A	7421	01	5478
GLE 2380 / 2580AV	0,60	BPMR6F	1270	-	-
Kentucky 36, Mac 17 / 21	0,60	BMR6F	2144	11	7683
Mac 22 / 23	0,60	BM7A	6521	10	6793
Mac 25 / 26 / 30 / 30AV / 281	0,60	BMR6F	2144	11	7683
Mac 32 / 37	0,60	B6HS	4510	-	-
Mac 38AV	0,60	BMR6F	2144	11	7683
Mac 52	0,60	B6S	3510	09	6048
Mac 60SX / 65 / 65SL / 80A / 80SL / 80SX	0,60	BMR6F	2144	11	7683
Mac 90 / 95 / 99 / 99SL	0,60	BMR6F	2144	11	7683
Mac 2815 / 2816 / 2817 / 2825 / 2827	0,60	BMR6F	2144	11	7683
Mac 3214 / 3216	0,60	BPMR6F	1270	-	-
Mac 3225 / 3227 / 3227HD	0,60	BMR6F	2144	11	7683
Mac 3516 / 3818	0,60	BPMR6F	1270	-	-
Mac GHT 17 / 19 / 22	0,60	BMR6F	2144	11	7683
MD 290 / 320 1AV / 330AV, MT 280X / 310X / 320	0,50	BMR6F	2144	11	7683
PM 2025	0,60	BPMR6F	1270	-	-
PM 2100	0,50	BMR6F	2144	11	7683
PM 2320L	0,70	BMR6A	7421	01	5478
PM 2510, PM 2560	0,60	BPMR6F	1270	-	-
PM 2635J	0,70	BMR6A	7421	01	5478
PM 3100 / 3600 / 4100 4150	0,50	BMR6F	2144	11	7683
PMAC 38 AV	0,70	BMR6A	7421	01	5478
Prater 31	0,60	BMR6F	2144	11	7683
Pro Mac 3000 / 3800 Super / 4200 Super	0,60	BMR6F	2144	11	7683
Pro Mac 38 AV	0,70	BMR6A	7421	01	5478
Pro Mac I HD / II HD / III HD	0,60	BMR6F	2144	11	7683
Pro Mac I Super / II Super / III HD	0,60	BMR6F	2144	11	7683
Pro Mac IV HD	0,60	BM6F	6221	11	7683
Pro-Scalper 28S / 32HDS	0,60	BMR6F	2144	11	7683
Pro-Scalper I / II, Roadrunner I / II / III	0,60	BMR6F	2144	11	7683
Silver Eagle 28 / 32	0,60	BMR6F	2144	11	7683
SMac.30 / AV	0,60	BMR6A	7421	01	5478
Super Mac 28 / 30 AV / 38 AV	0,60	BMR6F	2144	11	7683
Super Mac 80 / 85 / S / SL / SX	0,60	BMR6F	2144	11	7683
Titan 2000 / 2030 / 2100 / 2250 / 2310 / 2360	0,60	BPMR6F	1270	-	-
Titan 25810-GLE	0,60	BPMR6F	1270	-	-
Titan 3000, Titan GHT 24 / 30	0,60	BMR6F	2144	11	7683
Titan GLE 2380 / 2500 / 2560AV	0,60	BPMR6F	1270	-	-
Titan GLE 2580AV / 3000 / 3900	0,60	BPMR6F	1270	-	-
Titan GPO22, Titan TD 4200 Super	0,60	BMR6F	2144	11	7683
Trim Mac 210	0,70	BPMR7A	4626	02	5959
Trim Mac 24 / 26	0,60	BMR6A	7421	01	5478
Versailles 41, Windsor Kit 28	0,60	BMR6F	2144	11	7683

Modèle

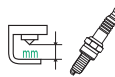
 N° STOCK BOÎTE
 N° BLISTER
 N° STOCK BLISTER

McCULLOCH - Générateurs

GY-15, GY-20	0,70	BPM4A	5928	-	-
H 1500/2000/3000, HP 1200/2000/3000/5000	0,60	BR6S	3522	09	6048
HP 3500 Deluxe, HP 5000 Deluxe, Mark I / II / III	0,60	BR6S	3522	09	6048
MPP 600 E / 800 E / 1500 E / 2300 E / 3500 E	0,60	B-4H	4110	-	-
RA 120 / 150 / 200 / 330 / 400ES	0,60	BMR6A	7421	01	5478
Virginia MH 555	0,50	BMR6F	2144	11	7683

McCULLOCH - Outils Divers

Tvoli 45 / 60, Virginia MH 542 / MH 548 / MH 555	0,50	BMR6F	2144	11	7683
--	------	-------	------	----	------

MCCULLOCH - Tondeuses

Tous modèles	0,70	BR2-LM	5798	06	4740
--------------	------	--------	------	----	------

MCCULLOCH - Tronçonneuses

0-0, 1-10, 2-10 / A / G, 3-10 / E	0,60	BMR6F	2144	11	7683
0-10	0,60	BM6F	6221	11	7683
10-10 / A / L	0,60	BMR6F	2144	11	7683
1-40, 1-50 Séries, 1-60 Séries, 1-70, 1-71, 1-72	0,60	BR6S	3522	09	6048
4-10, 5-10 / A / E / G, 6-10 / A, 7-10 / A	0,60	BM7F	6421	-	-
55	0,60	BM6F	6221	11	7683
660	0,80	BR6S	3522	09	6048
795 / L, 797, 895	0,60	BMR6F	2144	11	7683
836 / 838 / 951 / 955 / 961	0,50	BPMR6F	1270	-	-
B407	0,60	BM6F	6221	11	7683
California / 90	0,60	BMR6F	2144	11	7683
CP-55	0,60	BM6F	6221	11	7683
CP-70 / L, CP-125 / S	0,60	BM7F	6421	-	-
CS340 Mot. 34.4cc 1.7 hp	0,60	BPMR7A	4626	02	5959
CS380 Mot. 38.2cc 1.9 hp	0,60	BPMR7A	4626	02	5959
CS410 Elite Mot. 40.9cc 2.1 hp	0,60	BPMR7A	4626	02	5959
CS450 Elite Mot. 45.7cc 2.7 hp	0,60	BPMR7A	4626	02	5959
Daytona 1000	0,70	BMR6F	2144	11	7683
Daytona 3000	0,70	BPMR6A	6726	08	5063
Double Eagle 50 / 80, Eagle 50	0,60	BMR6F	2144	11	7683
Eagle Beaver 2 / 2.1 / 2.3 / 3.4 / 3.7	0,60	BMR6F	2144	11	7683
Eagle Beaver 10 / 12 / 14 / 16	0,60	BMR6F	2144	11	7683
Eagle Beaver 2000 / 2100AV / Super 2300AV	0,60	BPMR6F	1270	-	-
G-70, G-170	0,60	BM7F	6421	-	-
LA795, LA797 / LA	0,60	BMR6F	2144	11	7683
LG-6, Mac 10 séries 4-10 / 5-10	0,60	BM7F	6421	-	-
Mac 100 / 110 / 120 / 130 / 140 / 160S	0,60	BMR6F	2144	11	7683
Mac 1-10, 2-10 / A / G, 3-10 / E	0,60	BM6F	6221	11	7683
Mac 3200 / 3500AV / 3800AV	0,60	BPMR6F	1270	-	-
Mac 330 Cat. 4600, 4900, 5500	0,60	BMR6F	2144	11	7683
Mac 836 / 838 / 839 Cat.	0,60	BPMR6F	1270	-	-
Mac Cat 16, Super 16AV, Mac Cat 18, Super 18AV	0,60	BPMR6F	1270	-	-
Mac S-10A / SLG-6	0,60	BM7F	6421	-	-
Might-Might	0,60	BM7A	6521	10	6793
Mini Mac 1 / A, 6 / A, 25, 30, 35 / AS / CP, CP55	0,60	BMR6F	2144	11	7683
Mini Mac 883	0,60	BPMR6F	1270	-	-
Mini Pro 25 / 30 / 35	0,60	BM6F	6221	11	7683
MM-1 / -6 / -6A / -25 / -30 / -35 / -35AS	0,60	BM6F	6221	11	7683
MS 1432, 1635/AV, 1838AV	0,60	BPMR6F	1270	-	-
Mustang, P-10-10A	0,60	BMR6F	2144	11	7683
PH 390 & PM-690 Cuts-All	0,60	BMR6F	2144	11	7683
PM-6 / 6A / 310 / 320 / 330 / 340 / 360 / 364 / 374	0,60	BMR6F	2144	11	7683
PM-394 / 470 / 480 / 484 / 484X / 486	0,60	BMR6F	2144	11	7683
PM-494AS / 570 / 805	0,60	BM6F	6221	11	7683
PM-55 / 105 / 110 / 120 / 130 / 140	0,60	BMR6F	2144	11	7683
PM-610 / 640 / 650 / 800 / 850	0,60	BMR6F	2144	11	7683
PM-81	0,60	BM7F	6421	-	-
Power Mac 310 / 320 / 330 / 340 / 380 / 390 / 410	0,60	BMR6F	2144	11	7683
Pro 10-10A / 10-10S, Pro-Mac 1000 / 1010	0,60	BMR6F	2144	11	7683
Pro-Mac 6 / 6A	0,60	BM6F	6221	11	7683
Pro-Mac 7	0,50	BMR6F	2144	11	7683
Pro-Mac 10-10S / 10-700	0,60	BMR6F	2144	11	7683
Pro-Mac 36 / 38AV / 40 / 46	0,50	BMR6F	2144	11	7683
Pro-Mac 51 / 55	0,50	BPMR6F	1270	-	-
Pro-Mac 60 / 105	0,60	BM7F	6421	-	-
Pro-Mac 140 / 310 / 320 / 330 / 340	0,60	BM6F	6221	11	7683
Pro-Mac 380	0,60	BPMR6F	1270	-	-
Pro-Mac 550 / 555 / 570, Pro-Mac 5700AV / 5720	0,60	BMR6F	2144	11	7683
Pro-Mac 605 / 640 / 645 / 655 / 690	0,60	BMR6F	2144	11	7683
Pro-Mac 795 L, Pro-Mac 810	0,60	BMR6F	2144	11	7683
Pro-Mac 850	0,60	BM7F	6421	-	-

Modèle

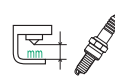
 N° STOCK BOÎTE
 N° BLISTER
 N° STOCK BLISTER

Pro-Mac 2500 / 3205AV-14 / 3505AV-16	0,60	BPMR6F	1270	-	-
Pro-Mac 3800 / 8200	0,60	BM7F	6421	-	-
Pro-Mac 3805AV-18	0,60	BPMR6F	1270	-	-
Pro-Mac 4700AV / 5000	0,60	BMR6F	2144	11	7683
Pro-Mac 8200AV	0,60	BPMR6F	1270	-	-
S 2-10A, S 10-10 / A / E / L / LA	0,60	BMR6F	2144	11	7683
S 6-10A	0,60	BM7F	6421	-	-
S797	0,60	BMR6F	2144	11	7683
Silver Eagle SE 2012 / B, 2014 / K	0,60	BPMR6F	1270	-	-
Silver Eagle SE 2016 / 2116 / 2316 / 2318	0,60	BPMR6F	1270	-	-
Silver Eagle SE 2818 AVS / 3020 AVS	0,60	BMR6F	2144	11	7683
Silver Eagle SE 3420 / 3720 AV	0,60	BMR6F	2144	11	7683
SLG-6	0,60	BM7F	6421	-	-
SP-40 / 55 / 125	0,60	BMR6F	2144	11	7683
SP-50 / 60 / 70 / 80 / 81 / 105 / 125C	0,60	BM7F	6421	-	-
Titan 560 / 620	0,60	BPMR6A	6726	08	5063
Titan 7, 35, 40, 50, 57, 70, Wildcat 18	0,60	BMR6F	2144	11	7683

MCDONOUGH - Tondeuses

Tous modèles	0,70	BR2-LM	5798	06	4740
--------------	------	--------	------	----	------

McLANE - Débroussailluses

Mot. B&S 3.5 hp	0,70	BR2-LM	5798	06	4740
Mot. B&S 5 / 8hp	0,80	B2-LM	1147	06	4740
Mot. Honda 2.2 hp	0,60	BM4A	5628	-	-
Mot. Honda OHV 4 hp, Mot. Kawasaki OHV 5 hp	0,70	BP4ES	6928	-	-
Mot. Kohler 4 hp	0,80	B2-LM	1147	06	4740

MCLANE - Tondeuses

Mot. B&S 3.5 / 4 / 5 / 5.5 / 6 hp	0,70	BR2-LM	5798	06	4740
Mot. Honda 2.5 hp	0,60	BM4A	5628	-	-
Mot. Honda 4 HP	0,70	BR6HS	3922	-	-
Mot. Kawasaki 5 hp	0,80	BPR5ES	7422	03	6854
Mot. Kohler K91 4 hp	0,70	BR2-LM	5798	06	4740

MEAD - Manutention

Modèle MM	0,60	B6S	3510	09	6048
Speed Cat	0,60	AB-6	2910	-	-

MEADE - Tondeuses

Tous modèles	0,70	BR2-LM	5798	06	4740
--------------	------	--------	------	----	------

MELROE - Manutention

M440, M444	0,60	B-6L	3212	-	-
M500 - Mot. Ford Ind	0,60	BP6ES	7811	04	7678
M500 - Mot. Kohler K321	0,60	B-6L	3212	-	-
M500 - Mot. Kohler K662 24 hp	0,60	B6S	3510	09	6048
M500 - Mot. Kohler Twin 18 hp	0,60	UR4	6630	-	-
M500 - Mot. Mitsubishi 4G32	0,70	BPR4ES	7222	-	-
M500 - Mot. Winconsin VH4D	0,60	AB-6	2910	-	-

MEP - Tondeuses

Mot. B&S Monocylindre	0,70	BR2-LM	5798	06	4740
Mot. Honda 2.5 hp	0,60	BM4A	5628	-	-
Mot. Tecumseh 3.5 / 3.8 / 4 / 5 / 5.5 hp	0,70	BR2-LM	5798	06	4740

MERCURY - Manutention

A460GT, A460PT - Mot. Ford	0,60	B-6L	3212	-	-
Banty - Ø18mm	0,60	AB-6	2910	-	-
Huskie, Super Huskie	0,60	B6S	3510	09	6048

MICHAELS - Tondeuses

Mot. B&S, Mot. Kohler K161 7 hp	0,70	BR2-LM	5798	06	4740
---------------------------------	------	--------	------	----	------

MIDDLESWORTH - Tondeuses

Mot. B&S	0,70	BR2-LM	5798	06	4740
Mot. Kohler	0,70	B-6L	3212	-	-

MIDLAND - Tondeuses

Culasse 18 mm	0,60	AB-6	2910	-	-
---------------	------	------	------	---	---

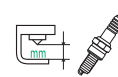
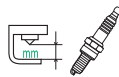

MIDWEST MOWERS - Tondeuses

Wegele 36 Mot. B&S Vanguard V-Twin 18 hp	0,70	BKR5ES	2460	07	4803
--	------	--------	------	----	------

MIGHTY MOUSE - Tondeuses

Mot. B&S	0,60	B2-LM	1147	06	4740
Mot. Wisconsin	0,60	AB-6	2910	-	-

MILBRADT - Tondeuses

Ø18 mm	0,60	AB-6	2910	-	-
--------	------	------	------	---	---

MILLER STURDI-SAW - Tronçonneuses

MCS-1 - Mot. Honda OHV 8 / 13 hp	0,80	BPR5ES	7422	03	6854
Mot. Honda OHV 11 hp	0,80	BPR5ES	7422	03	6854
Mot. Kohler 15 hp	0,80	BKR5E	7938	07	4803
MSM - Mot. Honda OHV 8 / 13 hp	0,80	BPR5ES	7422	03	6854

MILWAUKEE - Tondeuses

Culasse Ø18 mm	0,80	AB-6	2910	-	-
----------------	------	------	------	---	---

MITSUBISHI - Débroussailleuses

TL 20 / 23 / 26 / 43 / 52	0,60	BM6A	5921	01	5478
---------------------------	------	------	------	----	------

MITSUBISHI - Générateurs

EH 63 D / 65 D	0,70	BPR6ES	7822	04	7678
G 3L, G 4L	0,60	B6S	3510	09	6048
G 4L-A	0,60	B-4	3210	-	-
G 5L, G 6L	0,60	B6S	3510	09	6048
G 6L-A	0,60	B-4	3210	-	-
G 7L	0,60	B6S	3510	09	6048
G 7L-4	0,60	B-4	3210	-	-
G 8L	0,60	B6S	3510	09	6048
G 270	0,60	BMR6A	7421	01	5478
G 271	0,80	BM6A	5921	01	5478
G 350	0,60	BP6HS	4511	-	-
G 351	0,80	BM6A	5921	01	5478
G 400	0,70	BM6A	5921	01	5478
G 510	0,60	BP4HS	3611	-	-
G 511	0,80	BM6A	5921	01	5478
G 710	0,60	BR6S	3522	09	6048
G 711	0,80	BM6A	5921	01	5478
G 910, GM 130 / 131	0,80	BP5ES	6511	03	6854
G 1050	0,80	BM6A	5921	01	5478
GM 82	0,60	BP6HS	4511	-	-
GM 82 PN	0,70	BPR6HS	7022	-	-
GM 90 / 91	0,80	BP5ES	6511	03	6854
GM 131 P	0,90	BPR5ES	7422	03	6854
GM 132	0,60	BP6HS	4511	-	-
GM 132 PN	0,70	BPR6HS	7022	-	-
GM 150 PV / 150 V, GM 180 / 181	0,80	BP5ES	6511	03	6854
GM 181 P	0,90	BPR5ES	7422	03	6854
GM 182	0,60	BP6HS	4511	-	-
GM 182 PN	0,70	BPR6HS	7022	-	-
GM 220 / 221 / 231 / 290 / 291	0,80	BP5ES	6511	03	6854
GM 291 PN	0,70	BPR5ES	7422	03	6854
GM 301	0,80	BP5ES	6511	03	6854
GM 301 PN	0,70	BPR5ES	7422	03	6854
GM 391	0,80	BP5ES	6511	03	6854
GM 401	0,80	BPR5ES	7422	03	6854
GM 401 PN	0,70	BPR5ES	7422	03	6854
Katsura H3, 4	0,60	B-4	3210	-	-
Katsura K5, 6, 8, 10	0,60	BP-4	2911	-	-
Katsura SK10AM	0,70	BP4ES	6928	-	-
L 06 P / L 08 / L 1L / L 2L	0,60	B-4	3210	-	-
MG 1300-D, MG 2000-D	0,60	BM6A	5921	01	5478
MG 650-D	0,60	BM6A	5921	01	5478
MG 3000	0,60	BR6S	3522	09	6048
MG 3000-D	0,60	BM6A	5921	01	5478
MG 3001	0,80	BPR5ES	7422	03	6854
MGA 1200	0,70	BPR6HS	7022	-	-
MGA 1800 - Mot. OHV 4 hp	0,90	BPR5ES	7422	03	6854
MGA 1801	0,70	BPR6HS	7022	-	-
MGA 2900 - Mot. OHV 6 hp	0,90	BPR5ES	7422	03	6854

MGA 2901	0,70	BPR6HS	7022	-	-
MGC 1101 - Mot. OHV 2.4 hp	0,60	BPR6HS	7022	-	-
MGE 200 A - Mot. OHV 13 hp	0,90	BPR5ES	7422	03	6854
MGE 12000, MGE 13000 T	0,70	BPR6ES	7822	04	7678
MGE 1800 - Mot. OHV 4 hp	0,90	BPR5ES	7422	03	6854
MGE 1801	0,70	BPR6HS	7022	-	-
MGE 2900 - Mot. OHV 6 hp	0,90	BPR5ES	7422	03	6854
MGE 2901	0,70	BPR6HS	7022	-	-
MGE 4000 - Mot. OHV 8 hp	0,90	BPR5ES	7422	03	6854
MGE 4000 Z	0,70	BPR5ES	7422	03	6854
MGE 4800 - Mot. OHV 10 hp	0,90	BPR5ES	7422	03	6854
MGE 4800 Z	0,70	BPR5ES	7422	03	6854
MGE 5800 - Mot. OHV 13 hp	0,90	BPR5ES	7422	03	6854
MGE 5800 Z	0,70	BPR5ES	7422	03	6854
MGE 6700 - Mot. OHV 13 hp	0,90	BPR5ES	7422	03	6854
MGE 6700 Z	0,70	BPR5ES	7422	03	6854
MGW 200 A - Mot. OHV 13 hp	0,90	BPR5ES	7422	03	6854
MP 050, MP 080	0,90	BPR5ES	7422	03	6854
MP 25 / 40 / 50 / 80 / 100	0,60	BR4-LM	4133	05	4358
MPT 080, MPT 100	0,90	BPR5ES	7422	03	6854
N 25, NE 35K	0,60	B6S	3510	09	6048
T 50 / 80 / 110 / 130 / 140 / 170 / 200 / 340 / 350	0,80	BM6A	5921	01	5478
T 400	0,60	BPM4A	5928	-	-
T 400 PV	0,70	BPM7A	7321	02	5959
T 430	0,60	BP-4	2911	-	-
TL 20 / 23	0,60	BM6A	5921	01	5478
TL 26 / 33 / 43 / 52	0,60	BMR6A	7421	01	5478
TM 18 / 21 / 24 / 33	0,80	BM6A	5921	01	5478

MITSUBISHI - Manutention

FG-10 / 15 / 20 / 25, FG-30, FG-35, FG-40	0,70	BPR4ES	7222	-	-
G3L, 4L/5L/6L/7L/8L/N25	0,60	B6S	3510	09	6048
G4L-A, G6L-A, G7L-4, L06P, L08, L1L, L2L	0,60	B-4	3210	-	-
NE-35K	0,60	B6S	3510	09	6048

MLW - Tondeuses

Mot. B&S 5 hp	0,70	BR2-LM	5798	06	4740
---------------	------	--------	------	----	------

MODERN - Débroussailleuses

Tous modèles	0,70	B4-LM	3410	05	4358
--------------	------	-------	------	----	------

MONARK - Tondeuses

Mot. Aspera, Mot. B&S	0,60	B4-LM	3410	05	4358
Mot. Suffolk	0,60	B6S	3510	09	6048
Tous modèles	0,70	BR2-LM	5798	06	4740

MONDIAL - Tronçonneuses

640 / AV, 645, 650, 655 Cayman, 657, 665, 675S	0,80	BPMR7A	4626	02	5959
--	------	--------	------	----	------

MONO - Tondeuses

Mot. B&S	0,70	BR2-LM	5798	06	4740
Mot. Lauson	0,70	BR6S	3522	09	6048

MONO - Tronçonneuses

249	0,80	XR5	3332	-	-
25-10 / 25-14	0,60	BMR6A	7421	01	5478
47 / 67	0,80	BR6S	3522	09	6048
SL-146 / 147 / 245 / 247	0,60	BMR6A	7421	01	5478
SL-149	0,80	XR5	3332	-	-

MONTGOMERY-WARD - Tondeuses

Mot. B&S	0,70	BR2-LM	5798	06	4740
Mot. Lauson	0,70	BR6S	3522	09	6048
Mot. Tecumseh	0,80	B6S	3510	09	6048

MOTOMOWER - Tondeuses

Culasse Ø14 mm	0,70	BR6S	3522	09	6048
Culasse Ø18 mm	0,60	AB-6	2910	-	-

Modèle

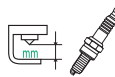
 N° STOCK BOÎTE
 N° BLISTER
 N° STOCK BLISTER

MOTT - Tondeuses

Mot. B&S	0,70	BR2-LM	5798	06	4740
Mot. Wisconsin TJD	0,60	AB-6	2910	-	-

MOUNTFIELD - Débroussaileuses

AM 180,MTL50	0,50	BPMR6A	6726	08	5063
Multi-trim 16 / 18 / 23 / 24 / 33 / 40	0,60	BMR6A	7421	01	5478
Multi-trim 31	0,50	BR6HS	3922	-	-
Multi-Zrim 33 / 40	0,50	BMR6A	7421	01	5478

MOUNTFIELD - Tondeuses

Mot. Suzuki 2 tps	0,70	BPMR4A	6028	-	-
Mot. Suzuki 4 tps	0,80	BPR6ES	7822	04	7678

MOW WING - Tondeuses

Tous modèles	0,70	BR2-LM	5798	06	4740
--------------	------	--------	------	----	------

MOW-A-MAT - Tondeuses

Tous modèles	0,70	BR2-LM	5798	06	4740
--------------	------	--------	------	----	------

MOWAMATIC - Tondeuses

Mot. B&S	0,60	B2-LM	1147	06	4740
Mot. Clinton, Mot. Clinton VS200	0,70	BR6S	3522	09	6048

MOW-CYCLE - Tondeuses

Tous modèles	0,70	BR2-LM	5798	06	4740
--------------	------	--------	------	----	------

MOW-MASTER - Tondeuses

Mot. Clinton	0,70	B-6L	3212	-	-
Mot. Power Pak, Mot. Propulsion	0,70	BR6S	3522	09	6048

MOW-MORE - Tondeuses

Tous modèles	0,80	AB-6	2910	-	-
--------------	------	------	------	---	---

MOW-MOWER - Tondeuses

Tous modèles	0,70	BR2-LM	5798	06	4740
--------------	------	--------	------	----	------

MOZ-ALL - Tondeuses

Tous modèles	0,70	BR2-LM	5798	06	4740
--------------	------	--------	------	----	------

MQ POWER - Générateurs

Mot. Honda OHV 8 / 11 hp	0,70	BP5ES	6511	03	6854
Mot. Robin EY-25	0,60	B6HS	4510	-	-
Mot. Robin EY-40DS	0,60	BPR4HS	7823	-	-
Mot. Wisconsin 4.6 hp, Mot. Wisconsin 7.5 / 11 hp	0,60	B6HS	4510	-	-

MTD - Débroussaileuses

500 / 600 / 700 / 710AS	0,60	BPMR6F	1270	-	-
-------------------------	------	--------	------	---	---

MTD PRO - Débroussaileuses

81 C62 / C73, ST 23/26/35	0,70	BPMR7A	4626	02	5959
---------------------------	------	--------	------	----	------

MTD PRO - Tondeuses

Mot. Kawasaki OHV 5.5 hp	0,80	BPR5ES	7422	03	6854
--------------------------	------	--------	------	----	------

MTD - Tondeuses

Cub Cadet Mot. B&S Fonte	0,70	BR2-LM	5798	06	4740
Cub Cadet Mot. B&S Intek	0,80	BKR5E	7938	07	4803
Cub Cadet Mot. B&S Standard/IC	0,70	BR2-LM	5798	06	4740
Cub Cadet Mot. B&S Vanguard/Europa OHV	0,70	BKR5E	7938	07	4803
Cub Cadet Mot. Kawa. Typ FG 230 D CS 50	0,60	BP4HS	3611	-	-
Cub Cadet Mot. Kawasaki Typ FE 250 D	0,60	BPR5ES	7422	03	6854
Cub Cadet Mot. Kohler Com. CV/CH 11-16	1,10	BKR5E-11	6953	-	-
Cub Cadet Mot. Kohler Com. CV/CH 18-25	0,70	BKR5E	7938	07	4803
Cub Cadet Mot. Tecumseh	0,70	BR2-LM	5798	06	4740
Cub Cadet Mot. Tecumseh OHV	0,70	BR7ES	5122	-	-

Modèle

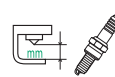
 N° STOCK BOÎTE
 N° BLISTER
 N° STOCK BLISTER

Gold 11A-B22Q704 Honda OHC 160cc	0,80	BPR5ES	7422	03	6854
Gold 12AVD32Q704 Honda OHC 160cc	0,80	BPR5ES	7422	03	6854
Gold 13AP925P004 Kohler Cour. 2-Cyl. 23hp	0,70	BKR5ES	2460	07	4803
Gold 13AX795S004 Kohler Cour. 1-Cyl. 20hp	0,70	BKR5ES	2460	07	4803
Gold 13AX795T004 Kohler Cour. 1-Cyl. 20hp	0,70	BKR5ES	2460	07	4803
Gold 13AX915T004 Kohler Cour. 2-Cyl. 22hp	0,70	BKR5ES	2460	07	4803
Gold 17AF2ACK004RZT Kohler Cour. V2 26hp	0,70	BKR5ES	2460	07	4803
Gold 17AF2ACP004RZT Kohler Cour. V2 25hp	0,70	BKR5ES	2460	07	4803
Gold 17AF2ACS004RZT Koh. Cour. 2Cyl. 22hp	0,70	BKR5ES	2460	07	4803
Gutbrod Mot. B&S Fonte	0,70	BR2-LM	5798	06	4740
Gutbrod Mot. B&S Intek	0,70	BKR5E	7938	07	4803
Gutbrod Mot. B&S Standard/IC	0,70	BR2-LM	5798	06	4740
Gutbrod Mot. B&S Vanguard/Europa OHV	0,70	BKR5E	7938	07	4803
Gutbrod Mot. Kawasaki Typ FE 250 D	0,60	BPR5ES	7422	03	6854
Gutbrod Mot. Kawasaki Typ FG 230 D CS 50	0,60	BP4HS	3611	-	-
Gutbrod Mot. Kohler Comand CV/CH 11-16	1,10	BKR5E-11	6953	-	-
Gutbrod Mot. Kohler Comand CV/CH 18-25	1,10	BKR5E	7938	07	4803
Gutbrod Mot. Tecumseh	0,70	BR2-LM	5798	06	4740
Gutbrod Mot. Tecumseh OHV	0,70	BR7ES	5122	-	-
Mot. 1P65 / 1P61 / 1P70MO / 2P70MO	0,70	BPR6ES	7822	04	7678
Mot. B&S	0,80	B4-LM	3410	05	4358
Mot. B&S 10A902 4 hp, Mot. B&S 5 / 5.5 hp	0,70	BR2-LM	5798	06	4740
Mot. Kawasaki FD620D 20 hp	1,00	BMR2A-10	4452	-	-
Pro 12AKC31E095 Mot. Kohler OHV 149cc	0,70	DCPR6E	3481	-	-
White Mot. B&S Fonte	0,70	BR2-LM	5798	06	4740
White Mot. B&S Intek	0,80	BKR5E	7938	07	4803
White Mot. B&S Standard/IC	0,70	BR2-LM	5798	06	4740
White Mot. B&S Vanguard/Europa OHV	0,70	BKR5E	7938	07	4803
White Mot. Kawasaki Typ FE 250 D	0,60	BPR5ES	7422	03	6854
White Mot. Kawasaki Typ FG 230 D CS 50	0,60	BP4HS	3611	-	-
White Mot. Kohler Comand CV/CH 11-16	1,10	BKR5E-11	6953	-	-
White Mot. Kohler Comand CV/CH 18-25	0,70	BKR5E	7938	07	4803
White Mot. Tecumseh	0,70	BR2-LM	5798	06	4740
White Mot. Tecumseh OHV	0,70	BR7ES	5122	-	-
Yard Machines Mot. B&S Fonte	0,70	BR2-LM	5798	06	4740
Yard Machines Mot. B&S Intek	0,80	BKR5E	7938	07	4803
Yard Machines Mot. B&S Standard/IC	0,70	BR2-LM	5798	06	4740
Yard Machines Mot. B&S Vang./Europa OHV	0,70	BKR5E	7938	07	4803
Yard Machines Mot. Kawa. Typ FG230D CS50	0,60	BP4HS	3611	-	-
Yard Machines Mot. Kawasaki Typ FE 250 D	0,60	BPR5ES	7422	03	6854
Yard Machines Mot. Kohler Com. CV/CH 11-16	1,10	BKR5E-11	6953	-	-
Yard Machines Mot. Kohler Com. CV/CH 18-25	0,70	BKR5E	7938	07	4803
Yard Machines Mot. Tecumseh	0,70	BR2-LM	5798	06	4740
Yard Machines Mot. Tecumseh OHV	0,70	BR7ES	5122	-	-
Yard Man Mot. B&S Fonte	0,70	BR2-LM	5798	06	4740
Yard Man Mot. B&S Intek	0,80	BKR5E	7938	07	4803
Yard Man Mot. B&S Standard/IC	0,70	BR2-LM	5798	06	4740
Yard Man Mot. B&S Vanguard/Europa OHV	0,70	BKR5E	7938	07	4803
Yard Man Mot. Kawa. Typ FG 230 D CS 50	0,60	BP4HS	3611	-	-
Yard Man Mot. Kawasaki Typ FE 250 D	0,60	BPR5ES	7422	03	6854
Yard Man Mot. Kohler Comand CV/CH 11-16	1,10	BKR5E-11	6953	-	-
Yard Man Mot. Kohler Comand CV/CH 18-25	0,70	BKR5E	7938	07	4803
Yard Man Mot. Tecumseh	0,70	BR2-LM	5798	06	4740
Yard Man Mot. Tecumseh OHV	0,70	BR7ES	5122	-	-

MURAUDEUR - Tondeuses

Tous modèles	0,60	B-4	3210	-	-
--------------	------	-----	------	---	---

MURRAY - Tondeuses

20102 - Mot. B&S 3.5 hp, 22105 - Mot. B&S 3.75hp	0,70	BR2-LM	5798	06	4740
22506 - Mot. B&S 5.75 hp	0,70	BR2-LM	5798	06	4740
Mot. B&S / Tecumseh, Mot. B&S 10 / 12.5 / 13 hp	0,70	BR2-LM	5798	06	4740
Mot. B&S 16.5 / 20 / 21 hp	0,70	BKR5ES	2460	07	4803
Mot. B&S 4 / 4.5 / 5.5 / 6 hp	0,70	BR2-LM	5798	06	4740
Mot. B&S Intek OHV 6.5 hp	0,70	BKR5ES	2460	07	4803
Mot. B&S OHV 15.5 / 17 hp	0,70	BKR5ES	2460	07	4803
Mot. B&S Twin 14 / 18 hp	0,60	BR6S	3522	09	6048
Mot. Tecumseh 13.5 hp	0,70	BR6ES	4922	-	-
Mot. Tecumseh OHV 12 / 16 hp	0,60	B6HS	4510	-	-
Mot. Tecumseh OHV 18 hp	0,70	BR6ES	4922	-	-
Mot. Tecumseh TC300 2 hp	0,70	BPMR6A	6726	08	5063
Mot. Tecumseh TVS90 3.8 hp	0,70	BR2-LM	5798	06	4740

MURRY - Tondeuses

Tous Modèles	0,80	B2-LM	1147	06	4740
--------------	------	-------	------	----	------

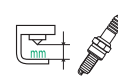
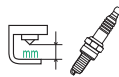

MUSTANG - Tondeuses

Mot. B&S	0,70	BR2-LM	5798	06	4740
Mot. B&S 5 / 8 hp	0,80	B2-LM	1147	06	4740

NAC - Débroussailleuses

NX 180 / 240 / 350	0,70	BMR6A	7421	01	5478
--------------------	------	-------	------	----	------

NAMCO - Manutention

42PG-1000, 44PG-1000	0,60	AB-6	2910	-	-
Onan - CCK, CCKB	0,60	B-6L	3212	-	-
Onan NHBV	0,60	BR6ES	4922	-	-

NATIONAL MOWER - Tondeuses

Mot. B&S 3 / 10 hp	0,70	BR2-LM	5798	06	4740
Mot. B&S Vanguard V-Twin 16 hp	0,80	BKR5E	7938	07	4803
Mot. Kawasaki 7,5 hp	0,80	BP5HS	4111	-	-
Mot. Kohler 12 hp	0,70	B-6L	3212	-	-
Mot. Wisconsin	0,80	AB-6	2910	-	-

NATIONAL - Tondeuses

Mot. Kohler	0,60	B-4	3210	-	-
Reel Mower Mot. B&S	0,60	B2-LM	1147	06	4740

NAUDER - Tronçonneuses

NAU-10 / 12	0,70	BMR6A	7421	01	5478
-------------	------	-------	------	----	------

NAUTAC - Débroussailleuses

011F / R, 012R / RD, 026R / RF	0,70	BPMR7A	4626	02	5959
028Turbo, 030Turbo, 1100 T	0,70	BPMR7A	4626	02	5959
Country DR02 3.5 hp	0,70	BR4-LM	4133	05	4358
Country DR06 5 hp	0,70	BR2-LM	5798	06	4740
Country DR06S 6 hp	0,70	BR6HS	3922	-	-

NAUTAC - Tondeuses

Fainway 435BA Mot. F&S (SB 140 SL)	0,70	BR2-LM	5798	06	4740
Fainway 435FA Mot. Tecumseh (Prisma 37)	0,70	BR4-LM	4133	05	4358
Fainway 435FAE Mot. Tecumseh (Prisma 37)	0,70	BR4-LM	4133	05	4358
Greenfee 375, 375A Mot. B&S (Sprint 375)	0,70	BR2-LM	5798	06	4740
Greenfee 500BAD Mot. B&S (Quantum50)	0,70	BR2-LM	5798	06	4740
Greenfee 500BS Mot. B&S (Quantum50)	0,70	BR2-LM	5798	06	4740
Greenfee 500KA Mot. Kawasaki (FC 150)	0,80	BPR6ES	7822	04	7678
Greenfee 500S2A Mot. F&S (SB 140SL)	0,70	BP5S	3011	-	-
Mot. Tecumseh 5345 P 37 / XT 37	0,70	BR4-LM	4133	05	4358

NAUTAC - Tronçonneuses

Tous modèles	0,80	BPMR7A	4626	02	5959
--------------	------	--------	------	----	------

NEW HOLLAND - Tondeuses

GT20A - Mot. Kohler Command 20 hp	0,70	BKR5ES	2460	07	4803
GT22A - Mot. Kohler Command 22 hp	0,70	BKR5ES	2460	07	4803
MY16 - Mot. Kohler Command 16 hp	0,70	BKR5ES	2460	07	4803
MY17 - Mot. Kawasaki V-Twin 17 hp	0,70	BPMR6A	6726	08	5063
MY19 - Mot. Kawasaki V-Twin 19 hp	0,60	BCPR6ES	2330	-	-
MZ14H - Mot. B&S 14 hp, MZ16H - Mot. B&S 16 hp	0,70	BKR5ES	2460	07	4803
MZ18H - Mot. B&S 18 hp	0,70	BKR5ES	2460	07	4803
MZ19H - Mot. Kawasaki FH601V 19 hp	0,60	BCPR6ES	2330	-	-

NEW WAY - Tondeuses

Tous modèles	0,60	AB-6	2910	-	-
--------------	------	------	------	---	---

NIBBI - Manutention

NTR450 3MA+1RM - Mot. Honda GX160 OHV	0,80	BPR5ES	7422	03	6854
---------------------------------------	------	--------	------	----	------

NISSAN - Générateurs

D11, H20, J15, MA10, P40	0,70	BR4ES	1097	-	-
GX 1000 / 1600	0,80	BM6A	5921	01	5478
H 30	0,70	BR4HS	3322	-	-

NISSAN - Manutention

A12, A15	0,70	B5ES	6410	-	-
AL-01 Mot. K21 essence, AL-02 Mot. K25 essence	0,90	FR2A-D	4768	-	-
CL01, CL02 Mot. K21 GPL, CL02 Mot. K25 GPL	0,90	FR2A-D	4768	-	-
D11	0,80	BR5ES	4722	-	-
D11 (B Model)	0,70	B5ES	6410	-	-
F03 / F05, FX5 Mot. TB42	0,80	B4ES	4129	-	-
H20 (1980)	0,70	B4ES	4129	-	-
H20 (B Model)	0,70	B5ES	6410	-	-
H30 (1980)	0,70	B4ES	4129	-	-
H30 (B Model)	0,70	B5ES	6410	-	-
H30 / P	0,80	B4ES	4129	-	-
J15 (1980)	0,70	B4ES	4129	-	-
K01 / K02 / NK01	0,80	B4ES	4129	-	-
LX 35 Mot. K25 GPL	0,90	FR2A-D	4768	-	-
MA10	0,70	B4ES	4129	-	-
NF01 / NF02 / NK02	0,80	B4ES	4129	-	-
NHF01 (A,M), NHF02 (A,M)	0,80	BPR2ES	2264	-	-
P40 (1980), Z24	0,70	B4ES	4129	-	-

NOGMATIC - Tronçonneuses

4CV-ALL, NOG10, NOG12	0,70	BMR6A	7421	01	5478
6CV-All	0,70	BPMR6A	6726	08	5063

NOMA - Tondeuses

Mot. B&S 12 / 12,5 / 13 / 14 / 15 hp	0,70	BR2-LM	5798	06	4740
Mot. B&S 5 hp, Mot. B&S Twin 16,5 / 18 hp	0,70	BR2-LM	5798	06	4740
Mot. B&S Vanguard V-Twin 16 / 18 / 20 hp	0,80	BCPR5ES	6130	07	4803
Mot. Kohler OHV 15 hp	0,80	BCPR5ES	6130	07	4803
Mot. Kohler Twin 18 / 20 hp	0,60	BPR4FS	1127	-	-
Mot. Tecumseh 12 / 15 / 16 hp	0,80	B6HS	4510	-	-
Mot. Tecumseh 16,5 hp	0,80	B7ES	1111	-	-

NORLETT - Tondeuses

Mot. Aspera, Mot. B&S	0,60	B4-LM	3410	05	4358
-----------------------	------	-------	------	----	------

NOVICO - Tondeuses

Mot. B&S	0,70	BR2-LM	5798	06	4740
----------	------	--------	------	----	------

OLEO-MAC - Débroussailleuses

433 BP, 721, 727 / S / T, 733 / S, 740	0,70	BPMR7A	4626	02	5959
440 BP / 446 BP / 453 BP Ergo Mot. Emak	0,70	BPMR7A	4626	02	5959
746 T / 753 T Mot. Emak, 755 Master Mot. Emak	0,70	BPMR7A	4626	02	5959
BC 220 S Mot. Emak	0,70	CMR7H	3066	-	-
BC 240 D Euro 2 / 240 S / 240 T - Mot. Emak	0,70	CMR7H	3066	-	-
BC 260	0,80	CMR5H	7599	-	-
BC 280 S / 280 T / 320 S / 320 T - Mot. Emak	0,70	CMR7A	7543	-	-
BC 350 S / BC 350 T Mot. Emak	0,70	BPMR7A	4626	02	5959
BC 360	0,80	CMR5H	7599	-	-
BC 360 4S / BC 360 4T Mot. Emak	0,70	CMR5H	7599	-	-
BC 380 S / BC 380 T Mot. Emak	0,70	BPMR7A	4626	02	5959
BC 420 S / 420 T / 430 - Mot. Emak	0,70	BPMR7A	4626	02	5959
BCF 430 Mot. Emak	0,70	BPMR7A	4626	02	5959
DEB 56 Mot. Honda GXV 340 OHV	0,80	BPR5ES	7422	03	6854
DEB 516 / DEB 526 Mot. Subaru EA 190V	0,70	BPR7HS	6422	-	-
DEB 5156 Mot. Subaru EA 190V	0,70	BPR7HS	6422	-	-
Sparta 42 / 42 BP / 44 Mot. Emak	0,70	BPMR7A	4626	02	5959
Sparta 250 S / 250 T / 250 TR Mot. Emak	0,70	BPMR8Y	2218	-	-
Sparta 380 S / 380 T Mot. Emak	0,70	BPMR7A	4626	02	5959
Sparta 440 BP / 440 T Mot. Emak	0,70	BPMR7A	4626	02	5959
TDF 51 Mot. Kawasaki FJ 180V OHV	0,80	BPR5ES	7422	03	6854
TDF 516 Mot. Subaru EA 190V	0,70	BPR7HS	6422	-	-
TDF 60 Mot. Kawasaki FJ 180V OHV	0,80	BPR5ES	7422	03	6854
Tuareg 4X4 92 Mot. B&S Vanguard 23 hp	0,80	BKR5E	7938	07	4803
Tuareg 92 Mot. B&S Vanguard 20 hp	0,80	BKR5E	7938	07	4803
WB 55 HR 6,5 Mot. Honda GX 200 OHV	0,80	BPR5ES	7422	03	6854
WB 65 HR 8,5 Mot. Honda GX 270 OHV	0,80	BPR5ES	7422	03	6854
WB 80 KR Mot. Kohler CH395	0,80	BKR5E	7938	07	4803

OLEO-MAC - Générateurs

251TV, TV40, 261TV, 481TV, 260TT, 480TT-A	0,50	BPM6A	7021	08	5063
720	0,70	BPMR7A	4626	02	5959

Modèle

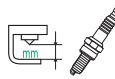
 N° STOCK BOÎTE
 N° BLISTER
 N° BLISTER

OLEO-MAC - Générateurs				
730 T / S, 735 T / S, 740 T / S	0,50	BPMR7A	4626	02 5959
746 T / 750 Master / 750 T, 825 T / S	0,70	BPMR7A	4626	02 5959
930	0,50	BPMR7A	4626	02 5959
931	0,70	BPMR6A	6726	08 5063
935 / 935 DF	0,50	BPMR7A	4626	02 5959
936 / 940 / 942 / 946 / 951	0,70	BPMR7A	4626	02 5959
940 S, 945 / 945 DF	0,50	BPMR7A	4626	02 5959
945 AF	0,50	BPMR6A	6726	08 5063
950 / 950 FS	0,50	BPMR7A	4626	02 5959
950 AF	0,50	BPMR6A	6726	08 5063
956 / 962 / 970 / 971 / 980 / 981	0,70	BPMR7A	4626	02 5959
999 / 999 F, AM 150 / 180	0,50	BPMR7A	4626	02 5959
C 19 20 - Mot. Emak	0,60	BPMR6A	6726	08 5063
FS 45 TL - Mot. B&S Serie 550	0,70	BKR6E	6962	- -
HT 26 / 43	0,70	BPMR7A	4626	02 5959
HT 26 S	0,50	BPMR7A	4626	02 5959
MTL 30 / 40 / 80 / 106	0,60	BPM7A	7321	02 5959
MTL 50 / 81 R	0,70	BPMR7A	4626	02 5959
SA 30 TLA - Mot. Emak	0,60	BPMR6A	6726	08 5063
Sparta 26 / 26 S / TR	0,70	BPMR7A	4626	02 5959
WP 300 - Mot. Emak	0,60	BPMR6A	6726	08 5063

OLEO-MAC - Outils Divers				
AM 162 / BV 162 / BV 270 Mot. Emak	0,70	BPMR6A	6726	08 5063
BV 270BP / BV 300 Mot. Emak	0,70	BPMR6A	6726	08 5063
FDX 13/150 Mot. Honda GX 160 OHV	0,80	BPR5ES	7422	03 6854
FDX 18/220 Mot. Honda GX 390 OHV	0,80	BPR5ES	7422	03 6854
MB 800 Mot. Emak	0,70	BPMR7A	4626	02 5959
MH 2 Mot. Subaru EH 035	0,70	BMR6A	7421	01 5478
MH 2 PH Mécabèche GX50 Mot. Honda GX 50	0,70	CR5HSB	6535	- -
MH 3 Pro Mot. Mitsubishi GT 400	0,70	BPR6HS	7022	- -
MH 3D / MH 3PH Mot. Mitsubishi GT 241	0,70	BPR6HS	7022	- -
MH 4 Pro-EP16 Mot. Subaru EP 16 OHC	0,70	BR4HS	3322	- -
MH 4D Mot. Subaru EP 16 OHC	0,70	BR4HS	3322	- -
MH 6 Pro Mot. Subaru EP 17 OHC	0,70	BR4HS	3322	- -
MH 506 DX Mot. Honda GX 160 OHV	0,80	BPR5ES	7422	03 6854
MHA 54 Mot. Subaru EX 13 OHC	0,70	BR6HS	3922	- -
MHT 61 F / MHT 61 FLB Mot. Subaru EP 17 OHC	0,70	BR4HS	3322	- -
MTL 51 Mot. Emak	0,70	BPMR6A	6726	08 5063
MTL 85 Mot. Emak	0,70	BPMR8Y	2218	- -
Multimate Mot. Emak	0,70	BPMR7A	4626	02 5959
OMB 4 Mot. B&S Serie 550	0,80	BKR6E	6962	- -
OMB 6 Mot. Subaru EP 17 OHC	0,70	BR4HS	3322	- -
OS 255 Mot. Emak	0,70	BPMR7A	4626	02 5959
SC 150 Mot. Emak	0,70	BPMR6A	6726	08 5063
SCA 38 Mot. B&S Serie 550	0,80	BKR6E	6962	- -
SCA 40 Mot. Subaru EP 16 OHC	0,70	BR4HS	3322	- -
SCA 50 Mot. Subaru EP 17 OHC	0,70	BR4HS	3322	- -
SP 126 Mot. Emak	0,70	BPMR7A	4626	02 5959

OLEO-MAC / NIBBI - Manutention				
NTR 2250 - Mot. Honda GX160 OHV	0,80	BPR5ES	7422	03 6854
NTR 270 - Mot. Honda GCV135	0,80	BPR6ES	7822	04 7678
NTR 450 - Mot. Honda GX120 OHV	0,80	BPR5ES	7422	03 6854
NTR 550 - Mot. Honda GX160 OHV	0,80	BPR5ES	7422	03 6854
TN 2700 - Mot. B&S 625	0,70	BR2-LM	5798	06 4740
TN 3400 - Mot. B&S 750	0,80	BCP5ES	7496	07 4803
TN 3500 / TN 4500 - Mot. Honda GX120 OHV	0,80	BPR5ES	7422	03 6854
TN 5600 / TN 5600H - Mot. Honda GX160 OHV	0,80	BPR5ES	7422	03 6854
TN 5600HD - Mot. Honda GX160 OHV	0,80	BPR5ES	7422	03 6854

OLEO-MAC / NIBBI - Outils Divers				
BRIK 1 K Mot. Emak K800 H	0,80	BKR6E	6962	- -
BRIK 3 Mot. Honda GC 160	0,90	BPR6ES	7822	04 7678
KAM 5 Junior Mot. Honda GX 200 OHV	0,80	BPR5ES	7422	03 6854
KAM 5F CH395 Mot. Kohler CH395	0,90	BKR5E	7938	07 4803
KAM 5HF Mot. Honda GX 270 OHV	0,80	BPR5ES	7422	03 6854
MH 130 Mot. Honda GX 25	0,70	CMR5H	7599	- -
MH 150 R Mot. B&S 550	0,80	BKR6E	6962	- -
MH 150 RK Mot. Emak K700 H	0,80	BKR6E	6962	- -
MH 150 RX Mot. Honda GX 120 OHV	0,80	BPR5ES	7422	03 6854
MH 180 RK Mot. Emak K700 H	0,80	BKR6E	6962	- -
MH 210 R Mot. Honda GX 160 OHV	0,80	BPR5ES	7422	03 6854

Modèle

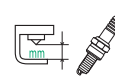
 N° STOCK BOÎTE
 N° BLISTER
 N° BLISTER

MH 260 R Mot. Honda GX 200 OHV	0,80	BPR5ES	7422	03 6854
MZ 2030 Mot. Honda GX 25	0,70	CMR5H	7599	- -
MZ 2050 RK Mot. Emak K800 H	0,80	BKR6E	6962	- -

OLEO-MAC - Tondeuses				
Cheyenne 92D Mot. B&S Vanguard 23 hp	0,90	BKR5E	7938	07 4803
Cheyenne 110H Mot. B&S Vanguard 23 hp	0,90	BKR5E	7938	07 4803
G 48 TBXE Comfort PlusMot. B&S 675	0,70	BR2-LM	5798	06 4740
G 48 TK Allroad EXA 4 Mot. Emak K650 OHV	0,80	BKR6E	6962	- -
G 53 TBX Allroad Plus4 Mot. B&S 625	0,70	BR2-LM	5798	06 4740
G 53 THX Allroad Mot. Honda GCV160 OHC	0,80	BKR6E	6962	- -
G 53 THX Allroad Plus4 Honda GCV160 OHC	0,80	BKR6E	6962	- -
G 53 TK Allroad EXA 4 Mot. Emak K800 OHV	0,80	BKR6E	6962	- -
G 53 TK Allroad Plus4 Mot. Emak K800 OHV	0,80	BKR6E	6962	- -
G 53THX Comfort Mot. Honda GCV160 OHC	0,80	BKR6E	6962	- -
G 53VBD Allroad Plus4 Mot. B&S 750	0,80	BCP5ES	7496	07 4803
G44P Essential Mot. B&S Serie 450E	0,70	BR2-LM	5798	06 4740
G44PK Essential Mot. Emak K500 OHV	0,80	BKR6E	6962	- -
G44PK Mot. Emak K500 OHV	0,80	BKR6E	6962	- -
G44TK Essential Mot. Emak K500 OHV	0,80	BKR6E	6962	- -
G48TB(P) Essential Mot. B&S Serie 450E	0,70	BR2-LM	5798	06 4740
G48TBR Allroad Plus4 Mot. B&S 575EX OHV	0,70	BR2-LM	5798	06 4740
G48TBX Allroad EXA 4 Mot. B&S 625	0,70	BR2-LM	5798	06 4740
G48TBX confort PlusMot. B&S 625	0,70	BR2-LM	5798	06 4740
G48TH Allroad Mot. Honda GCV135	0,90	BPR6ES	7822	04 7678
G48TK Allroad K650 Mot. Emak K650 OHV	0,80	BKR6E	6962	- -
G48TK Allroad Plus4 Mot. Emak K650 OHV	0,80	BKR6E	6962	- -
G48TK Essential Mot. Emak K600 OHV	0,80	BKR6E	6962	- -
G53TBX Allroad EXA 4 Mot. B&S 650 RS	0,70	BR2-LM	5798	06 4740
G53TBX Confort Mot. B&S 625	0,70	BR2-LM	5798	06 4740
G53TBX Confort PlusMot. B&S 625	0,70	BR2-LM	5798	06 4740
G53TH "190KM" Confort Honda GCV190	0,80	BKR6E	6962	- -
G53THX Allroad EXA 4 Honda GCV160 OHC	0,80	BKR6E	6962	- -
G53TK Essential Mot. Emak K650 OHV	0,80	BKR6E	6962	- -
G53TK K650 Mot. Emak K650 OHV	0,80	BKR6E	6962	- -
G55VBX 4en1 Mot. B&S 650 RS	0,70	BR2-LM	5798	06 4740
Krosser 80/12,5T B&S Pow. Built 3125 AVS	0,90	BCPR5ES	6130	07 4803
Krosser 92/13,5T B&S Pow. Built 3130 AVS	0,90	BKR5E	7938	07 4803
Krosser 92/15,5T B&S Pow. Built 4155 AVS	0,90	BKR5E	7938	07 4803
Krosser Plus92 Mot. Kawa. V-Twin 16hp	0,80	BPR4ES	7222	- -
Krosser Plus92/16H Kawa. V-Twin 16hp	0,80	BPR4ES	7222	- -
LUX 55 HXF Mot. Honda GXV160 OHV	0,80	BKR6E	6962	- -
LUX 55TBI Mot. B&S Prim'n Pull 825	0,90	BKR5E	7938	07 4803
Max 48TBX Allroad Alu. Mot. B&S	0,70	BR2-LM	5798	06 4740
Max 48TK Alu. Allroad Emak K650 OHV	0,80	BKR6E	6962	- -
Max 53 TH "190KM" Pluscut Honda GCV190	0,80	BKR6E	6962	- -
Max 53TK Alu. Allroad Emak K800 OHV	0,80	BKR6E	6962	- -
Max44TBX 'PC' Mot. B&S 625	0,70	BR2-LM	5798	06 4740
Max44TK Ed. Limitée Mot. Emak K600 OHV	0,80	BKR6E	6962	- -
Max48TBX 'PC' Mot. B&S 650 RS	0,70	BR2-LM	5798	06 4740
Max48TK - K600 Mot. Emak K650 OHV	0,80	BKR6E	6962	- -
Max48TK - K650 Mot. Emak K650 OHV	0,80	BKR6E	6962	- -
Max53 TH190 Allroad Alu. Honda GCV190	0,80	BKR6E	6962	- -
Max53TBDF 'PC' Mot. B&S 700	0,70	BR2-LM	5798	06 4740
Max53TBX Mot. B&S 675	0,70	BR2-LM	5798	06 4740
Max53TK Mot. Emak K800 OHV	0,80	BKR6E	6962	- -
OM 101C 16K H Mot. Emak K1600 AVD 16hp	0,90	BKR5E	7938	07 4803
OM 101C/16K H Mot. Emak K1600 AVD 16hp	0,90	BKR5E	7938	07 4803
OM 106 S 17,5H Mot. B&S Intek 4175	0,90	BKR5E	7938	07 4803
OM 106 S 18H B&S Vanguard V-Twin 18 hp	0,90	BKR5EZ	7642	07 4803
OM 106J/15,5H B&S Pow. Built 4155 AVS	0,90	BKR5E	7938	07 4803
OM 106J/17,5H Mot. B&S Intek 4175	0,90	BKR5E	7938	07 4803
OM 106J/24H 4x4 B&S Vanguard 8240 24hp	0,90	BKR5E	7938	07 4803
OM 124 S 22H Mot. B&S Intek 7220 22 hp	0,90	BKR5EZ	7642	07 4803
OM 72C 13 H B&S Pow. Built 3130 AVS 13hp	0,90	BKR5E	7938	07 4803
OM 72C/12,5K H Mot. Emak K1250 AVD	0,90	BKR5E	7938	07 4803
OM 84 - 12,5 KH Emak K1450 AVD 14,5hp	0,90	BKR5E	7938	07 4803
OM 91 Plus14,5K H Emak K1450 AVD 14,5hp	0,90	BKR5E	7938	07 4803
OM 92S 13H B&S Pow. Built 3130 AVS 13 hp	0,90	BKR5E	7938	07 4803
OM 92S 16H Mot. B&S Intek 7160	0,90	BKR5E	7938	07 4803
OM 98L/14,5 H Mot. Emak K1450 AVD 14,5 hp	0,90	BKR5E	7938	07 4803
Rider Mistral B&S Pow. Built 3130 AVS 13 hp	0,90	BKR5E	7938	07 4803
Storm 108/15,5T B&S Pow. Built 4155 AVS	0,90	BKR5E	7938	07 4803
Tomado 95/11,5T B&S Pow. Built 3115 AVS	0,90	BCPR5ES	6130	07 4803
Tomado 97/13,5 B&S Pow. Built 3130 AVS	0,90	BKR5E	7938	07 4803
Tomado 97/13T B&S Pow. Built 3130 AVS	0,90	BKR5E	7938	07 4803
Tomado 108/15,5T B&S Pow. Built 4155 AVS	0,90	BKR5E	7938	07 4803

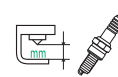
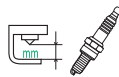

OLEO-MAC - Tronçonneuses

233 / 234	0,80	BPMR7A	4626	02	5959
240 / 244 / 246 FDL, 250 A, 251 A / B / Super E1	0,50	BPMR7A	4626	02	5959
250 B, 252 / F, 254 / F, 260 Auto / 261	0,50	BPMR7A	4626	02	5959
264 / F / FDLX / TTA	0,80	BPMR7A	4626	02	5959
271, 272 / F, 274 TTA, 280, 281, 284 / F / TTA	0,50	BPMR7A	4626	02	5959
335, 340 / F, 350 / S, 355 / F	0,50	BPMR7A	4626	02	5959
350 A / AF	0,50	BPMR6A	6726	08	5063
355 A / AF, 460	0,50	BPM6A	7021	08	5063
460 S / AS, 480 / S / AS, 481 / MP, 482 / MP	0,50	BPMR7A	4626	02	5959
930 / 940 / 942 / 946 / 951	0,50	BPMR7A	4626	02	5959
932C-30cm 3/8 Mot. Emak	0,70	BPMR6A	6726	08	5063
932C-35cm 3/8 Mot. Emak	0,70	BPMR6A	6726	08	5063
935 / 935 DF / 945 / 945 DF	0,50	BPMR7A	4626	02	5959
937-35cm 3/8 Mot. Emak	0,70	BPMR6A	6726	08	5063
938 / 941 / 970	0,80	BPMR7A	4626	02	5959
940C-41cm Mot. Emak	0,70	BPMR6A	6726	08	5063
945 A / AF, 950 A / AF	0,50	BPMR6A	6726	08	5063
947-41cm Mot. Emak	0,70	BPMR7A	4626	02	5959
950 / F / FS	0,50	BPMR7A	4626	02	5959
952-46cm Mot. Emak	0,70	BPMR7A	4626	02	5959
962-46cm Mot. Emak, 962-51 CM Mot. Emak	0,70	BPMR6A	6726	08	5063
963 TTA 12' Mot. Emak, 963 TTA 14' Mot. Emak	0,70	BPMR8Y	2218	-	-
980 Pro 5.5hp	0,50	BPMR6A	6726	08	5063
983 TTA 14' Mot. Emak	0,70	BPMR8Y	2218	-	-
999 / 999 F, AM150, AM180	0,50	BPMR7A	4626	02	5959
B45 / A / AF, B52 / A / AF	0,50	BPMR6A	6726	08	5063
B55 / A / AF	0,50	BPM6A	7021	08	5063
BC 240 H Mot. Emak	0,70	CMR7H	3066	-	-
BC280 H Mot. Emak	0,70	CMR7A	7543	-	-
Blitz 300 / 304 / 400 / 500 / 501S	0,50	BPM6A	7021	08	5063
Blitz 502 / F, 504 / F, 600 / AV	0,50	BPM6A	7021	08	5063
Blitz 700, 702 / MP, 800, 802 / MP	0,50	BPM6A	7021	08	5063
Blitz B54 A / F	0,50	BPMR6A	6726	08	5063
Carpi 245, 550, 761, Cutter 3, 4, 6, 7	0,50	BPM6A	7021	08	5063
FAP 40F, Folux 3, 4, 5, 6, 7, 8	0,50	BPM6A	7021	08	5063
GS 44-41cm Mot. Emak, GS 440-41cm Mot. Emak	0,70	CMR7A	7543	-	-
GS 350-3/8"-BCPI 41 Mot. Emak	0,70	BPMR6A	6726	08	5063
GS 370-35cm Mot. Emak	0,70	BPMR7A	4626	02	5959
GS 410C-41cm Mot. Emak	0,70	BPMR7A	4626	02	5959
GS 520-46cm Mot. Emak	0,70	BPMR7A	4626	02	5959
GS 650 TRON. 3/8 51cm Mot. Emak	0,70	BPMR8Y	2218	-	-
GS 720-51cm & GS 820-64cm Mot. Emak	0,70	BPMR8Y	2218	-	-
GS260-25 cm 1/4 Carving Mot. Emak	0,70	BPMR6A	6726	08	5063
GS260-25 cm 3/8 Mot. Emak	0,70	BPMR6A	6726	08	5063
GS940 (PS400) Mot. Emak	0,60	CMR6A	1223	-	-
HC 260XP Mot. Emak	0,70	BPMR7A	4626	02	5959
HC 265XP Mot. Emak, HC 275XP Mot. Emak	0,70	BPMR7A	4626	02	5959
HC 280XP Mot. Emak, HCS 280XP Mot. Emak	0,70	BPMR7A	4626	02	5959
HCS 275XP Mot. Emak, HT27, HT27L	0,70	BPMR7A	4626	02	5959
Olympic 240, 244 / F, 251, 254 / F, 261	0,50	BPM6A	7021	08	5063
OM GS 350 C 3/8" Mot. Emak	0,70	BPMR6A	6726	08	5063
PP250 Mot. Emak	0,70	BPMR7A	4626	02	5959
PP270 Mot. Emak, PPX270 Mot. Emak	0,70	CMR7A	7543	-	-
S 30 / 50 / 80 / 100, SA 18, 30 / TL, 45 / TL	0,50	BPMR7A	4626	02	5959
SC 21 / 23 / 33 / 55	0,50	BPMR7A	4626	02	5959
VAP 38, 44F, 50, 55 / F, 385	0,50	BPM6A	7021	08	5063

OLYMPIA - Tondeuses

Tous modèles	0,70	BR2-LM	5798	06	4740
--------------	------	--------	------	----	------

OLYMPIK - Tronçonneuses

254, 261, 264F / VS	0,70	BPM6A	7021	08	5063
271, 272 F, 284F, 335F, 480, 481, 482 MP	0,70	BPM6A	7021	08	5063
935 DF / F, 941, 942, 945 F	0,70	BPM6A	7021	08	5063
946, 950F	0,70	BPMR6A	6726	08	5063
951, 962, 970, 980, 999, 999F	0,70	BPM6A	7021	08	5063
Super 251 / 480 / 481	0,70	BPM6A	7021	08	5063

OMC - Manutention

Haulster (1983) - GPL, Mower (1980)	0,80	WR5	2438	-	-
Truckster - Mot. Kohler K181 8 hp	0,60	B2-LM	1147	06	4740
Truckster - Mot. Kohler K301 12 hp	0,60	B-6L	3212	-	-

OMC - Tronçonneuses

Tous modèles	0,60	BMR6A	7421	01	5478
--------------	------	-------	------	----	------

ONAN - Générateurs

0.3 TL-212R/1A	0,50	B4-LM	3410	05	4358
10JC, 15JC	0,50	B-6L	3212	-	-
1B	0,50	AB-6	2910	-	-
2.5 / 3 MALB - Marine	0,50	B-6L	3212	-	-
2.7 AJ Spec. K-N	0,50	BMR6A	7421	01	5478
2.8 Micro	0,60	BPR4HS	7823	-	-
4 BGD / E, 6.5NH-CR-16004P, 6.5NHD / E	0,60	TR5	2238	-	-
4 Micro	0,80	BPR5ES	7422	03	6854
4.5 MCE / 6.5 MCE - Marine	0,60	TR5	2238	-	-
5JB, 6.5 NH Spec. A-D	0,50	B-6L	3212	-	-
6.5 NH Spec. J&K, 6.5 NH-CR-16004N	0,50	BR6ES	4922	-	-
8 / 9 MME - Marine	0,80	BPR5ES	7422	03	6854
AAE, AH, AK, AJ, BH, CK, EL	0,50	B-6L	3212	-	-
B43G, B48G	0,60	BPR5EFS	2223	-	-
BF Gemini	0,40	B-6L	3212	-	-
CCK (Gas Naturel)	0,70	B7S	3710	-	-
CCK (Light Service)	0,60	B-4L	3112	-	-
CCK (Normal Service)	0,50	B-6L	3212	-	-
CJA	0,60	B-4L	3112	-	-
CW	0,50	AB-6	2910	-	-
GO	0,50	B6S	3510	09	6048
H60, HH20	0,50	B-6L	3212	-	-
HC / HK / HN / HR	0,50	AB-6	2910	-	-
IC	0,50	B6S	3510	09	6048
J30 / J60 / J120	0,60	B-6L	3212	-	-
JA, JB, JC	0,50	B-6L	3212	-	-
JT	0,50	AB-6	2910	-	-
KA, KB, KR	0,50	B6S	3510	09	6048
KKA	0,60	B-4L	3112	-	-
LK-LKB	0,50	B-6L	3212	-	-
Marquis I / III	0,60	TR4	3754	-	-
MGO, MPG, MUK	0,50	B6S	3510	09	6048
MH	0,60	B-6L	3212	-	-
MTK	0,50	AB-6	2910	-	-
N-52M	0,60	BPR5EFS	2223	-	-
NB	0,50	B-6L	3212	-	-
NH Gemini	0,40	B-6L	3212	-	-
NHA-MS, NHB-MS	0,60	BR6ES	4922	-	-
NHC	0,50	BR6ES	4922	-	-
NHC-MC (Early)	0,60	BR6ES	4922	-	-
NHC-MS (Late) (79-)	0,60	BPR5EFS	2223	-	-
NHP (LP-Gas)	0,40	BR6ES	4922	-	-
OTC	0,50	B6S	3510	09	6048
P Series	0,60	BPR5EFS	2223	-	-
Pro 4000 / 4000E	0,60	BPR4HS	7823	-	-
Pro 5000 / 5000E / 6000E	0,60	TR5	2238	-	-
T260 Series	0,60	BPR5EFS	2223	-	-
V45, W4A	0,50	AB-6	2910	-	-
WIB	0,50	B6S	3510	09	6048

OPEM - Tronçonneuses

130Z / 140Z / 142Z	0,50	BMR6A	7421	01	5478
140S / AV / H, 145 / AV / E, 146	0,70	BPMR6A	6726	08	5063
150 / 152 / 154	0,50	BPM7A	7321	02	5959
156, 157 / S, 158, 165, 166	0,70	BPMR6A	6726	08	5063
Jolly 155 / 155AV, K1 / K2	0,70	BPMR6A	6726	08	5063

ORLINE - Tronçonneuses

103, 123, Mark II	0,80	BM6A	5921	01	5478
Challenger Mark 11 D / S, Mustang 13 / 129 / 149	0,60	BMR6A	7421	01	5478
Yard-Arm	0,80	BM6A	5921	01	5478

OSBORNE - Manutention

Fire Fighter	0,60	AB-6	2910	-	-
--------------	------	------	------	---	---

OTTAWA - Manutention

FA-8 Yark Hustler	0,60	A6FS	2210	-	-
Tracto-Lift	0,60	AB-6	2910	-	-

Modèle

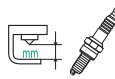
 N° STOCK BLISTER
 N° BOÎTE
 N° STOCK BLISTER
 N° BLISTER
PANTHER - Tondeuses

Tous modèles 0,70 BR2-LM 5798 06 4740

PARAMOUNT - Débroussailleuses
 PHT19, PLT 2145 0,70 BPMR6A 6726 08 5063
 PLT 2248 / 2651 / 2857 0,80 BM4A 5628 - -
PARMI - Tondeuses

Mot. B&S 0,70 BR2-LM 5798 06 4740

PARTNER - Débroussailleuses
 B 180 0,50 BMR6A 7421 01 5478
 B 200 / 205 0,70 BPMR7A 4626 02 5959
 B 250 0,50 BMR6A 7421 01 5478
 B 265 0,70 BPMR6A 6726 08 5063
 B 305 0,50 BMR6A 7421 01 5478
 B 322 / 323 / 325 / 370 / 380 0,70 BPMR7A 4626 02 5959
 B 400 / 405 / 440 / 450 / 450C / 450G 0,70 BPMR7A 4626 02 5959
 B 450 W 0,70 BR4-LM 4133 05 4358
 Colibri, Colibri Duo, Colibri Plus, Prof, Simplet 0,70 BPMR7A 4626 02 5959
 T 180 Colibri 0,70 BPMR6A 6726 08 5063
 T 221 0,60 BPMR7A 4626 02 5959
 T 225 0,50 BMR6A 7421 01 5478
 T 240 0,70 BPMR6A 6726 08 5063
 T 250 / 260 / 285 / 300 / 320 0,50 BMR6A 7421 01 5478
PARTNER - Générateurs
 10.90E, 121/C90E, 121/C95E, 121/C100E 0,60 BM6A 5921 01 5478
 31, 511 RT, 5110, 5112, 5510 0,70 BR2-LM 5798 06 4740
 GBI 32 0,50 BPMR6A 6726 08 5063
 LR10, LR12, LR13, LRH13, LT14, YTH16 0,70 BR2-LM 5798 06 4740
PARTNER - Outils Divers
 3-20, 3-51 0,70 BR6S 3522 09 6048
 HG 55-12 0,50 BPMR6A 6726 08 5063
PARTNER - Tondeuses
 11-90 E / 12-90 EH / 12-100 E / 13-90 EH 0,50 BR4-LM 4133 05 4358
 13-105 E / 14-105 E / 14-105 EH / 15-105 EH 0,50 BR4-LM 4133 05 4358
 146 / C / CD / CDE / E 0,50 BR2-LM 5798 06 4740
 147 C / CD / CDE / T 0,50 BR2-LM 5798 06 4740
 148CD, 150H, 155 CD / CDE / D 0,50 BR2-LM 5798 06 4740
 246 / 348 / 350 / 445 D, 446 R / RD / RDSV 0,50 BR2-LM 5798 06 4740
 450 R/M, 455 RD, 550, 555D, 556 DE 0,50 BR2-LM 5798 06 4740
 K12 0,60 BP6HS 4511 - -
 K12S / K16 / K500 / K650 / K700 / K1200 0,70 BPM7A 7321 02 5959
 P 115 0,60 BR7ES 5122 - -
 P 130 / 214 0,50 BR2-LM 5798 06 4740
PARTNER - Tronçonneuses
 225 0,70 BMR6A 7421 01 5478
 330 / 340 0,80 BMR7A 4226 10 6793
 345, 365 / CCS, 395 0,80 BPMR7A 4626 02 5959
 351 CCS / 370 CCS / 390 CCS 0,70 BPMR6A 6726 08 5063
 360 / 400, 410 / CCS, 460 CCS 0,80 BPMR7A 4626 02 5959
 405 / CCS, 450 / 465 / 495 / 550 / 650 0,80 BPMR7A 4626 02 5959
 420 CCS / 470 CCS 0,70 BPMR6A 6726 08 5063
 500 0,50 BPMR6F 1270 - -
 500 Formula / 510 CCS 0,80 BPMR7A 4626 02 5959
 540 / 540 PRO / 545 / 660 Pro 0,80 BPMR7A 4626 02 5959
 1618 0,80 BM6F 6221 11 7683
 1601 / 1602 0,70 BPMR6A 6726 08 5063
 1629 / 1630 / 1631 / 1644 / 1645 0,80 BR6S 3522 09 6048
 1632 / C, 1646 / C, 1647C, 1655 / B 0,80 BMR7A 4226 10 6793
 1633 B 0,70 BM7A 6521 10 6793
 1660 / 1661 / 1690 0,80 BR6S 3522 09 6048
 2055 / B 0,80 BMR7A 4226 10 6793
 5500 / 7700, 7700 Pro CCS 0,80 BPMR7A 4626 02 5959
 B17 / B172 / B173 0,70 BM7A 6521 10 6793
 B400 0,80 BM6A 5921 01 5478
 C6 0,70 BM7A 6521 10 6793

Modèle

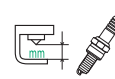
 N° STOCK BLISTER
 N° BOÎTE
 N° STOCK BLISTER
 N° BLISTER

 K-12 0,50 BPR6HS 7022 - -
 K-12S 0,80 BPM7A 7321 02 5959
 K-16 0,70 BM7A 6521 10 6793
 Mini IV 0,80 BMR6F 2144 11 7683
 Mini P 0,70 BM7A 6521 10 6793
 Mini P3 / P4 0,80 BM6F 6221 11 7683
 Mini PA 0,70 BM7A 6521 10 6793
 P-100, P-100S 0,80 BPMR7A 4626 02 5959
 P-350 0,80 BMR7A 4226 10 6793
 P-400 0,70 BPM6A 7021 08 5063
 P-48 / 49 / 50 0,70 BM7F 6421 - -
 P-500 / 5000 0,50 BPMR6F 1270 - -
 P-5000 Plus 0,70 BPM6A 7021 08 5063
 P-51 0,80 BPMR7A 4626 02 5959
 P-55 0,80 BMR7A 4226 10 6793
 P-65 0,80 BPMR7A 4626 02 5959
 P-70 0,80 BMR7A 4226 10 6793
 Partner Mini III / IV 0,80 BM6F 6221 11 7683
 R-11 0,70 BM7A 6521 10 6793
 R-12 0,50 BPR6HS 7022 - -
 R-14 / 14TS / 15, R-17T, R-18T 0,70 BM7A 6521 10 6793
 R-19 0,50 BM7A 6521 10 6793
 R-19T, R-20 / 20T 0,70 BM7A 6521 10 6793
 R-21 / 21T 0,80 BM6A 5921 01 5478
 R-22 / 22T 0,70 BM7A 6521 10 6793
 R-30 0,80 BM6A 5921 01 5478
 R-44T, R-85, R-417 / 417T / 420 / 420T / 421 / 421T 0,70 BM7A 6521 10 6793
 R-435 / 440, R-517 / 517T, R-523 0,70 BM7A 6521 10 6793
 S-330 / 340 / 350 0,80 BPM6F 5950 - -
PATHFINDER - Tondeuses

Tous modèles 0,70 BR2-LM 5798 06 4740

PAYLOADER - Manutention

GA-30, GA-40, GA-45A 0,60 AB-6 2910 - -

PECO - Tronçonneuses

Mot. Honda 11 / 13 hp 0,80 BPR5ES 7422 03 6854

PEERLESS - Tronçonneuses
 D25 / E75 / E95 / 141A 0,60 BMR6A 7421 01 5478
 D55 / D65 0,80 BR6S 3522 09 6048
 E10 0,70 BM7A 6521 10 6793
PEKTRA - Débroussailleuses

PF1ZT/PF2RT/PF3RTX 0,60 BPMR6F 1270 - -

PENNCREST - Tondeuses

Tous modèles 0,70 BR2-LM 5798 06 4740

PENNINGTON - Tondeuses
 Mot. B&S 0,70 BR2-LM 5798 06 4740
 Mot. Kohler 0,70 B-6L 3212 - -
 Mot. Onan 0,60 B-6L 3212 - -
 Mot. Wisconsin 0,80 AB-6 2910 - -
PERKINS - Générateurs
 G40203 0,60 B6ES 7310 - -
 G4-236 0,60 BP6ES 7811 04 7678
PETTIBONE MERCURY - Manutention
 GA-50 / 55A / 60A / 60J / 70J / 80 / 100 / 120 0,60 AB-6 2910 - -
 GS4-20, G-30, GS-40, GS-50 0,60 AB-6 2910 - -
 GSO-60J / 70J / 80 / 100 / 120 0,60 AB-6 2910 - -
PHÖNIX - Outils Divers
 PM 21 H 0,70 BPMR6A 6726 08 5063
 Primo 35 Mot. B&S, Primo 500 R Mot. B&S 0,70 BR2-LM 5798 06 4740
 Quatro 500 B Mot. B&S 0,70 BR2-LM 5798 06 4740

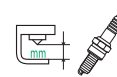
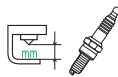
**PHÖNIX - Tondeuses**

AM 51B, PXR 40 / 48 - Mot. B&S	0,70	BR2-LM	5798	06	4740
BM 104B, 104T, 200T - Mot. Tecna	0,70	BR2-LM	5798	06	4740
PXR 45 / R - Mot. Tecna	0,70	BR2-LM	5798	06	4740
PXR 48 RHV - Mot. Honda	0,80	BPR5ES	7422	03	6854
PXR 48 RV / RVE, PXR 55RV - Mot. B&S	0,70	BR2-LM	5798	06	4740
Twin Cut 12,5 / 15,5 - Mot. B&S	0,70	BR2-LM	5798	06	4740
Twin Cut 16 - Mot. B&S	0,80	BKR5E	7938	07	4803

PINCOR - Tondeuses

Mot. B&S	0,70	BR2-LM	5798	06	4740
Mot. Pincor 2 tps & Mot. Pincor 4 tps	0,70	BR6S	3522	09	6048

PIONEER - Générateurs

700F, 700G (Heavy Service)	0,60	B8S	3810	-	-
700F, 700G (Light Service)	0,60	B6S	3510	09	6048
Blue Diamond - Mot. Pioneer	0,80	B6S	3510	09	6048
Gold Crown - Mot. B&S culasse 14 mm	0,60	B2-LM	1147	06	4740
Gold Crown - Mot. B&S culasse 18 mm	0,50	AB-6	2910	-	-
Gold Crown - Mot. Pioneer	0,80	B6S	3510	09	6048
Gold Crown - Mot. Wisconsin	0,60	AB-6	2910	-	-

PIONEER - Tondeuses

Mot. B&S	0,70	BR2-LM	5798	06	4740
Mot. Tecumseh	0,70	BR6S	3522	09	6048

PIONEER - Tronçonneuses

20, 20D	0,80	BM6A	5921	01	5478
400, 410, 450, 550, 600, 610, 620, 650, 700, 750	0,80	BR6S	3522	09	6048
970, 1072, 1073	0,70	BM7A	6521	10	6793
1014, 1074 / UB / E, 1100, 1110, 1120, 1130	0,60	BMR6A	7421	01	5478
1150, 1160, 1200, 1200A, 1410, 1410A, 1420, 1450	0,60	BMR6A	7421	01	5478
1520 / 1560 / 1750 / 1770 / 1771 / 2071 / 2073	0,60	BM7A	6521	10	6793
1850	0,60	BMR7A	4226	10	6793
2073	0,60	BM7A	6521	10	6793
2200, 2270, 2400, 2460, 3071, 3200, 3270, 3270S	0,60	BMR6A	7421	01	5478
Farmsaw, Farmsaw 2	0,70	BMR6A	7421	01	5478
GC	0,80	B6S	3510	09	6048
HA / HB / HC	0,60	BR6S	3522	09	6048
L	0,70	AB-6	2910	-	-
NU-17, One Man	0,60	BR6S	3522	09	6048
P-10 / P-12 / P-20	0,60	BM7A	6521	10	6793
P-21 / 21B / 21S / 21SB	0,60	BMR6A	7421	01	5478
P-25	0,60	BM7A	6521	10	6793
P-26E	0,60	BMR6A	7421	01	5478
P-26S	0,60	BM7A	6521	10	6793
P-28 / 28B / 28E / 28S / 28SB, P-35 / 35S	0,60	BMR6A	7421	01	5478
P-39	0,70	BPMR6A	6726	08	5063
P-40	0,60	BM7A	6521	10	6793
P-40 Light Service	0,60	BM6A	5921	01	5478
P-42	0,70	BPMR7A	4626	02	5959
P-50 / 51 / 51S	0,60	BM7A	6521	10	6793
P-52	0,70	BPMR7A	4626	02	5959
RA, Super, Super Twin, Twin	0,60	BR6S	3522	09	6048

PISTON POWERED PRODUCTS - Tronçonneuses

Super Saw	0,80	BMR6F	2144	11	7683
-----------	------	-------	------	----	------

POLARIS - Tondeuses

Mot. B&S 10.5 hp	0,70	BR2-LM	5798	06	4740
------------------	------	--------	------	----	------

POLORON - Tondeuses

Culasse Ø18mm	0,80	AB-6	2910	-	-
Mot. B&S, Tous modèles	0,70	BR2-LM	5798	06	4740

PONY POWER - Tondeuses

Tous modèles	0,70	BR2-LM	5798	06	4740
--------------	------	--------	------	----	------

PORTER CABLE - Tronçonneuses

Speedomatic KG8	0,60	B6S	3510	09	6048
-----------------	------	-----	------	----	------

POULAN - Tondeuses

F14-430Pirana - Mot. Kawasaki 15 hp	0,60	BCPR6ES	2330	-	-
Mot. B&S 4 / 6.5 hp	0,70	BR2-LM	5798	06	4740
Mot. B&S 6.75 hp	0,70	BKR5ES	2460	07	4803
Mot. Honda 5.5 hp	0,80	BPR5ES	7422	03	6854
PP 722 / 735 / 750 / 751 / 752 / 800M / 835	0,80	B2-LM	1147	06	4740
PP225 / 2260 / 22R55 / 20375 / 500	0,80	B2-LM	1147	06	4740

POULAN PRO - Débroussaileuses

25HHT Mot. 25cc	0,60	BPMR8Y	2218	-	-
BVM 200VS / BVM 210VS Mot. 25cc	0,60	BPMR8Y	2218	-	-
PL 200 / 500	0,70	BPMR6A	6726	08	5063
PP 025 Mot. 25cc, PP 033 Mot. 33cc	0,60	BPMR8Y	2218	-	-
PP 036	0,60	BPMR7A	4626	02	5959
PP 22	0,80	BPM6A	7021	08	5063
PP 100	0,70	BPMR6A	6726	08	5063
PP 111	0,80	BM4A	5628	-	-
PP 112 / 113	0,70	BPMR6A	6726	08	5063
PP 114	0,80	BM4A	5628	-	-
PP 115	0,70	BPMR6A	6726	08	5063
PP 117	0,80	BM4A	5628	-	-
PP 125 Mot. 25cc, PP 133 Mot. 33cc	0,60	BPMR8Y	2218	-	-
PP 135	0,80	BPM6A	7021	08	5063
PP 136	0,60	BPMR7A	4626	02	5959
PP 165	0,80	BM4A	5628	-	-
PP 175	0,70	BPMR6A	6726	08	5063
PP 176	0,80	BM4A	5628	-	-
PP 185 / 195	0,70	BPMR6A	6726	08	5063
PP 196	0,80	BM4A	5628	-	-
PP 200	0,70	BMR6A	7421	01	5478
PP 325 Mot. 25cc, PP 333 / PP 335 Mot. 33cc	0,60	BPMR8Y	2218	-	-
PP 2822 Mot. 28cc	0,60	BPMR8Y	2218	-	-
PPBP 30 Mot. 30cc	0,60	CMR6H	3365	12	4794
PPC 22 / 25 / 31	0,70	BM7A	6521	10	6793
PPWT 60022 Mot. B&S 625 Series	0,80	BR2-LM	5798	06	4740
PT 3000 / 6000 / 7000	0,70	BPMR6A	6726	08	5063

POULAN PRO - Tondeuses

111, 117	0,80	BM4A	5628	-	-
165, 175, PP185, PP195	0,70	BPMR6A	6726	08	5063
301ZX Mot. B&S Intek 16.5 hp	0,70	BKR5ES	2460	07	4803
420, PP442, 770, 800, 900	0,80	BMR6A	7421	01	5478
440	0,80	BM7A	6521	10	6793
461ZX Mot. B&S Professional Series 19.5 hp	0,70	BKR5ES	2460	07	4803
541ZX Mot. B&S Professional Series 22 hp	0,70	BKR5ES	2460	07	4803
2600, 2610, 2620	0,80	BM4A	5628	-	-
Mot. B&S 3 / 5 / 10 / 11 / 12 / 12.5 hp	0,70	BR2-LM	5798	06	4740
Mot. B&S Intek V-Twin OHV 17 / 18 hp	0,90	BKR5E	7938	07	4803
Mot. B&S Vanguard V-Twin 16 / 20 hp	0,90	BKR5E	7938	07	4803
Mot. Kohler 14 hp	0,70	BKR5ES	2460	07	4803
Mot. Kohler OHV 14 hp / V-Twin 18 hp	0,90	BKR5E	7938	07	4803
Mot. Tecumseh OHV 13 / 14.5 / 16.5 hp	0,80	BR7ES	5122	-	-
PB195H42LT Mot. B&S Intek 20 hp	0,70	BKR5ES	2460	07	4803
PB20H42YT Mot. B&S Intek V-Twin 20 hp	0,70	BKR5ES	2460	07	4803
PB22H46YT Mot. B&S Intek 22 hp	0,70	BKR5ES	2460	07	4803
PB23H48YT Mot. B&S Intek 23 hp	0,70	BKR5ES	2460	07	4803
PB26H54YT Mot. B&S Intek V-Twin 26 hp	0,70	BKR5ES	2460	07	4803
PBGT26H54 Mot. B&S Intek 26 hp	0,70	BKR5ES	2460	07	4803
PD 1842ST - Mot. Kohler Command 18 hp	0,70	BKR5ES	2460	07	4803
PD 18H42ST - Mot. Kohler Command 18 hp	0,70	BKR5ES	2460	07	4803
PD 2042ST / PD 20H42ST - Mot. B&S Intek 20 hp	0,70	BKR5ES	2460	07	4803
PD 20PH48ST - Mot. Kohler Com. 20 hp	0,70	BKR5ES	2460	07	4803
PD 25PH48ST - Mot. B&S Intek 25 hp	0,70	BKR5ES	2460	07	4803
PHT19	0,70	BPMR6A	6726	08	5063
PO 1538 - Mot. B&S OHV 15 hp	0,70	BKR5ES	2460	07	4803
PO 1742ST / PO 17H42ST - Mot. B&S OHV 17 hp	0,70	BKR5ES	2460	07	4803
PP 12538 / 125H38 / 125R38 / 12542 / 125H42	0,70	BR2-LM	5798	06	4740
PP 1242S / 12R38M / 1036S / 1136	0,70	BR2-LM	5798	06	4740
PP 1338 / 165H42	0,80	BR7ES	5122	-	-
PP 1442	0,90	BKR5E	7938	07	4803
PP 145H42 / 155H42 / 11536	0,70	BR2-LM	5798	06	4740
PP 16H46B, PP 18H46 / 1846	0,90	BKR5E	7938	07	4803
PPWT62522 Mot. B&S 625 Series 3.49 hp	0,70	BR2-LM	5798	06	4740
PR550N22SH Mot. B&S 550 Series 2.95 hp	0,70	BR2-LM	5798	06	4740

Modèle

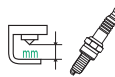
 N° STOCK BLISTER STOCK
BOÎTE BLISTER

POULAN PRO - Tondeuses				
PR625N21RH3 Mot. B&S 625 Series 3.49 hp	0,70	BR2-LM	5798	06 4740
PR625Y22RHP Mot. B&S 625 Series 3.49 hp	0,70	BR2-LM	5798	06 4740
PR625Y22RKP Mot. B&S 625 Series 3.49 hp	0,70	BR2-LM	5798	06 4740
PR625Y22SHP Mot. B&S 625 Series 3.49 hp	0,70	BR2-LM	5798	06 4740
PR7Y22MB Mot. Kohler 4.56 hp	0,70	BKR5ES	2460	07 4803

POULAN - Tronçonneuses				
10, 30	0,70	B7S	3710	- -
20, 20D, 25, 36	0,60	BMR6A	7421	01 5478
24 Deluxe	0,60	BM6A	5921	01 5478
25AV, 25DA, 25SN, 306A, 306SA	0,60	BMR6A	7421	01 5478
25-14-12 Multipurpose, 45-12	0,60	BM7A	6521	10 6793
45-12 Multi-Purpose, 52-12, 52-14	0,60	BMR7A	4226	10 6793
52-12, 52-14 Multi-Purpose	0,60	BM7A	6521	10 6793
53A, 54	0,80	BR6S	3522	09 6048
71A, 72, 76, 92, 100	0,60	BMR6A	7421	01 5478
210, 220	0,60	BPMR7A	4626	02 5959
225, 235	0,60	BMR6A	7421	01 5478
225A	0,60	BM6A	5921	01 5478
236, 255	0,60	BPMR7A	4626	02 5959
245A, 252A	0,60	BMR6A	7421	01 5478
285, 305	0,70	BM7A	6521	10 6793
306	0,60	BMR6A	7421	01 5478
325	0,60	BPMR7A	4626	02 5959
335, 336	0,70	BM7A	6521	10 6793
355	0,50	BPMR7A	4626	02 5959
361	0,60	BMR6A	7421	01 5478
365, 505	0,60	BPMR7A	4626	02 5959
415, 425	0,50	BPMR7A	4626	02 5959
533	0,80	BR6S	3522	09 6048
1900, 1900LE, 1950LE, 1975LE, 2055LE, 2250LE	0,60	BPMR7A	4626	02 5959
2050	0,50	BPMR7A	4626	02 5959
2055, 2075, 2075-ALL	0,60	BPMR7A	4626	02 5959
2100, 2375, 2400, 2450, 2500, 2550, 2600	0,50	BPMR7A	4626	02 5959
2150, 2155, 2175, 2250	0,50	BPMR7A	4626	02 5959
2700	0,60	BMR7A	4226	10 6793
2750	0,50	BPMR7A	4626	02 5959
2775	0,60	BPMR7A	4626	02 5959
2800	0,60	BMR7A	4226	10 6793
2900	0,50	BPMR7A	4626	02 5959
3000, 3100, 3300, 3350	0,60	BMR7A	4226	10 6793
3400	0,60	BPMR6A	6726	08 5063
3450	0,60	BMR7A	4226	10 6793
3700 (1980->)	0,60	BPMR6A	6726	08 5063
3750	0,60	BPMR7A	4626	02 5959
3800, 4000	0,60	BPMR6A	6726	08 5063
4400, 4900	0,60	BMR6A	7421	01 5478
6900, 7700, 8500, 8510	0,60	BM7A	6521	10 6793
5200CVA	0,60	BMR6A	7421	01 5478
5400, 5500	0,80	BMR7A	4226	10 6793
Bad Boy 3450	0,80	BMR7A	4226	10 6793
Bad Boy 3750	0,60	BPMR7A	4626	02 5959
KS412	0,50	BPMR7A	4626	02 5959
M25, 25DA, 25CVA, 306A, 245A, 361	0,60	BMR6F	2144	11 7683
Micro 25 / 25 Deluxe / 25 CVA, Micro 25SN	0,70	BM6A	5921	01 5478
Micro MZ5, Micro Super 25	0,60	BMR6A	7421	01 5478
Micro Super 25 Deluxe / 25 CAV	0,60	BMR6A	7421	01 5478
Micro XXV, Model XX	0,60	BMR6A	7421	01 5478
PP 190 Arborist / 210 / 225 / 230 / 235 / 236	0,50	BPMR7A	4626	02 5959
PP 255 / 260 / 295 / 310	0,50	BPMR7A	4626	02 5959
PP 285 / 305 / 325 / 335 / 335 Predator / 336	0,60	BMR7A	4226	10 6793
PP 315 / 365 / 380 / 405 / 415 / 425	0,50	BPMR7A	4626	02 5959
PP 3516AVX Mot. 35cc	0,60	BPMR7A	4626	02 5959
PP 375 / 385	0,60	BPMR6A	6726	08 5063
PP 445 / 455 / 475 / 505 / 525 / 655	0,50	BPMR7A	4626	02 5959
PP 3816AV Mot. 38cc	0,60	BPMR7A	4626	02 5959
PP 4218AV, PP 4218AVX Mot. 42cc	0,60	BPMR7A	4626	02 5959
PP 5020AV Mot. 50.8cc	0,60	BPMR7A	4626	02 5959
PPS 23 Arbor Pro, 25DA, 180, 200, 205, S23	0,50	BPMR7A	4626	02 5959
S25, S25AV, S25CVA, S25DA	0,60	BMR6A	7421	01 5478
S33, S53A, S54	0,80	BR6S	3522	09 6048
S68, S71A, S72, S76	0,60	BMR6A	7421	01 5478
S285, S305	0,70	BPM6A	7021	08 5063
Super 6000CVA	0,60	BPMR7A	4626	02 5959

Modèle

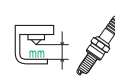
 N° STOCK BLISTER STOCK
BOÎTE BLISTER

Super XXV	0,60	BMR6A	7421	01 5478
Wild Thing 2175 / 2375	0,50	BPMR7A	4626	02 5959

POWER KING - Tondeuses				
Mot. B&S	0,80	B2-LM	1147	06 4740
Mot. Kohler 18 / 20 hp	0,70	BKR5ES	2460	07 4803
Mot. Kohler K301 12 hp / K321 14 hp	0,80	B-6L	3212	- -
Mot. Kohler K341 16 hp / K361 18 hp	0,80	B-6L	3212	- -
Mot. Kohler Twin 17 / 18 hp	0,60	BPR4FS	1127	- -
Mot. Kohler V-Twin 18 / 20 / 22 hp	0,80	BCPR5ES	6130	07 4803

POWER MATIC - Tondeuses				
Tous modèles	0,70	BR2-LM	5798	06 4740

POWER PRINCE - Débroussailleuses				
POWER PRINCE	0,70	BR6S	3522	09 6048

POWER PRODUCTS - Générateurs				
AH 36 Type 70	0,80	BM6A	5921	01 5478
AH 44 / 48 / 49	0,90	BM6A	5921	01 5478
AH 47 / 52 / 58 / 81	0,80	B6S	3510	09 6048
AV51	0,90	B6S	3510	09 6048

POWER PRUNER - Débroussailleuses				
Tree PP 1200/1250/1400/1600	0,70	BPMR6A	6726	08 5063
Tree PP 600	0,60	BPMR6F	1270	- -
Tree PP 800	0,60	BPMR7A	4626	02 5959

POWER TRAC - Tondeuses				
Mot. B&S Twin 18 hp	0,70	BR2-LM	5798	06 4740
Mot. B&S Vanguard V-Twin 18 hp	0,80	BKR5E	7938	07 4803
Mot. Kohler 22 hp, Kohler V-Twin 18 / 25 hp	0,80	BKR5E	7938	07 4803
Mot. Robin OHV 18 / 22 / 25 hp	0,80	BPR6ES	7822	04 7678
Mot. Tecumseh OHV 12.5 hp	0,70	BR6HS	3922	- -

POWERMOW - Tondeuses				
Tous modèles	0,70	BR2-LM	5798	06 4740

POYNTER - Tondeuses				
Tous modèles	0,70	BR2-LM	5798	06 4740

PRECISION-BUILT - Tondeuses				
Tous modèles	0,70	BR2-LM	5798	06 4740

PRIME MOVER - Manutention				
LL-40 - Mot. Ford 172 ci.	0,60	B-6L	3212	- -
LL-40 - Mot. Kohler	0,60	B6S	3510	09 6048
LL-40 - Mot. Winconsin	0,60	AB-6	2910	- -

PRO HIGH WHEEL - Tondeuses				
Mot. B&S / Tecumseh	0,70	BR2-LM	5798	06 4740

PRO SERIES - Tondeuses				
Mot. B&S	0,70	BR2-LM	5798	06 4740

PRO - Tondeuses				
Autres Mot. Clinton	0,70	BR6S	3522	09 6048
Mot. B&S	0,70	BR2-LM	5798	06 4740
Mot. Clinton 3.5 hp (2.8kW)	0,70	B-6L	3212	- -
Mot. Tecumseh	0,70	BR6S	3522	09 6048

PRO - Tronçonneuses				
10, 20, 30	0,70	B7S	3710	- -
40, 50	0,60	B6S	3510	09 6048
G300AVS, G300TS	0,70	BPMR6A	6726	08 5063

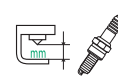
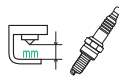
**PRO-MASTER - Tondeuses**

Mot. B&S	0,70	BR2-LM	5798	06	4740
Mot. B&S Vanguard V-Twin 16 hp	0,80	BCPR5ES	6130	07	4803
Mot. Honda OHV 3.5 & 5 hp	0,80	BP6ES	7811	04	7678
Mot. Honda OHV 4 / 5.5 hp	0,80	BPR5ES	7422	03	6854
Mot. Kawasaki 12.5 hp	0,60	BM6A	5921	01	5478
Mot. Kawasaki OHV 17 hp	0,80	BPR5ES	7422	03	6854
Mot. Kohler K91 4 hp	0,70	BR2-LM	5798	06	4740
Mot. Kohler OHV 14 hp	0,80	BCPR5ES	6130	07	4803
Mot. Kohler Twin 16 / 18 / 20 hp	0,60	BPR4FS	1127	-	-
Mot. Robin EY18W	0,70	BR6HS	3922	-	-
Mot. Wisconsin EY18W	0,60	B-4H	4110	-	-

PRO-STAR - Tondeuses

Mot. Kohler (Twin) 18 / 20 hp	0,60	BPR4FS	1127	-	-
-------------------------------	------	--------	------	---	---

PUBERT - Débroussailleuses

DF Pro 90 S Mot. Robin EX27	0,70	BR6HS	3922	-	-
First 06 55 H Mot. Honda GCV160	0,70	BPR5ES	7422	03	6854
L Junior 65 H Mot. Honda GSV190	0,70	BPR5ES	7422	03	6854
L Senior 110 H Mot. Honda GXV340	0,70	BPR5ES	7422	03	6854
Xtrem 04 65 H Mot. Honda GCV190	0,70	BPR5ES	7422	03	6854

PUBERT - Outils Divers

Compact 45 S C Mot. Robin EX13	0,70	BR6HS	3922	-	-
Eco 40 H C2 Mot. Honda GX120	0,70	BPR6ES	7822	04	7678
Elite 55 H C2 Mot. Honda GX160	0,70	BPR6ES	7822	04	7678
Fraise AR Roto 506 Mot. Honda GX160	0,70	BPR6ES	7822	04	7678
FT 545 S Mot. Robin EX13	0,70	BR6HS	3922	-	-
MB 25 H Mot. Honda GX25	0,60	CMR5H	7599	-	-
MB 50 H Mot. Honda GXH50	0,60	CR5HSB	6535	-	-
Primo 55 H D2 Mot. Honda GX160	0,70	BPR6ES	7822	04	7678
Primo Pro 55 H C2 Mot. Honda GX160	0,70	BPR6ES	7822	04	7678
Quatro Junior 55 H Mot. Honda GX160	0,70	BPR6ES	7822	04	7678
Quatro Senior 65 H D Mot. Honda GX200	0,70	BPR6ES	7822	04	7678
Quatro Senior 70 S Mot. Robin EX21	0,70	BR6HS	3922	-	-

PUBERT - Tondeuses

MF 40 H Mot. Honda GC135	0,70	BPR6ES	7822	04	7678
Oscar 40 H Mot. Honda GX120	0,70	BPR6ES	7822	04	7678
Oscar Pro 55 H Mot. Honda GX160	0,70	BPR6ES	7822	04	7678

QUALCAST - Tondeuses

Mot. B&S	0,70	BR2-LM	5798	06	4740
----------	------	--------	------	----	------

QUINSTAR - Tondeuses

Mot. B&S 8 / 12 hp	0,70	BR2-LM	5798	06	4740
Mot. B&S Vanguard (V-Twin) 14 hp	0,90	BKR5E	7938	07	4803

RAKET - Tronçonneuses

M 50, 60, 62, 75, 80, 110, 601, 621, 751	0,50	BPM7A	7321	02	5959
--	------	-------	------	----	------

RALLY - Tondeuses

Mot. B&S 3.5 / 3.75 / 4 / 5 / 10 / 11 / 12 / 12.5 hp	0,70	BR2-LM	5798	06	4740
Mot. B&S OHV 14 hp	0,80	BCPR5ES	6130	07	4803
Mot. B&S Twin 14 / 18 hp	0,70	BR2-LM	5798	06	4740
Mot. Tecumseh 12.5 hp	0,80	B6HS	4510	-	-
Mot. Tecumseh 3.5 hp	0,70	BR2-LM	5798	06	4740

RANGER - Manutention

Model V	0,60	B-6L	3212	-	-
---------	------	------	------	---	---

RANGER - Tondeuses

Ranger V / VII	0,70	B-6L	3212	-	-
----------------	------	------	------	---	---

RANSOMES - Tondeuses

KT 21 - Mot. Kohler	1,00	UR5	2771	-	-
Matador, Mastiff, Multimower	0,70	BR6HS	3922	-	-

Mot. B&S 3.5 hp	0,80	B2-LM	1147	06	4740
Mot. B&S 5 hp	0,70	BR2-LM	5798	06	4740
Mot. B&S N 52M 16 hp	0,70	BR6S	3522	09	6048
Mot. Ford 1.1L	0,90	BPR5ES-11	4424	-	-
Mot. Kawasaki N 52M	0,80	BMR6A	7421	01	5478
Mot. Kohler K181	0,70	BR6S	3522	09	6048
Mot. Onan N 52M	0,80	TR4	3754	-	-

RAPID MOWER - Tondeuses

Tous modèles	0,70	B-6L	3212	-	-
--------------	------	------	------	---	---

RED BIRD - Tondeuses

Tous modèles	0,70	BR2-LM	5798	06	4740
--------------	------	--------	------	----	------

RED CAP - Tondeuses

Tous modèles	0,70	BR2-LM	5798	06	4740
--------------	------	--------	------	----	------

RED E - Tondeuses

Culasse Ø14mm	0,70	BR6S	3522	09	6048
Culasse Ø18mm	0,60	AB-6	2910	-	-

RED MAX - Débroussailleuses

BC 200	0,70	BMR6A	7421	01	5478
BC 220 / 221 / 260	0,60	BPMR6A	6726	08	5063
BC 220DL / 260 DL	0,70	BMR6A	7421	01	5478
BC 261DL	0,60	BPMR7A	4626	02	5959
BC 262	0,60	BPMR6A	6726	08	5063
BC 280	0,60	BPMR6Y	5256	-	-
BC 2000 / 2001	0,60	BPMR7A	4626	02	5959
BC 2001DL	0,60	BPMR6A	6726	08	5063
BC 2300	0,60	BPMR7A	4626	02	5959
BC 2300DL	0,60	BPMR6A	6726	08	5063
BC 2600	0,60	BPMR7A	4626	02	5959
BC 340 / 340DL / 341DL / 342 / 342DL / 430DWM	0,60	BPMR6A	6726	08	5063
BC 440 / 440DWM / 441DWM / 442 / 442DWM	0,60	BPMR6A	6726	08	5063
BCZ 350S / 350SW	0,60	BPMR7A	4626	02	5959
BCZ 2460, BCZ 2610, BCZ 2650, BCZ 2660	0,60	CMR7H	3066	-	-
BCZ 3050 / 3060	1,00	CMR7H-10	1656	-	-
BL 200DL / 220DL / 260DL	0,60	BMR6A	7421	01	5478
BT 17 / 171 / 200 / 220 / 221	0,60	BMR6A	7421	01	5478
BT 280	0,60	BPMR6Y	5256	-	-
CHT 230	0,70	BMR7A	4226	10	6793
EXZ2460S-PH	0,60	CMR7H	3066	-	-
HT 230	0,70	BMR7A	4226	10	6793
HT 2460	0,60	CMR7H	3066	-	-
TR 2350S	0,60	BPMR7A	4626	02	5959

REDLINE - Débroussailleuses

Tous modèles	0,70	BPMR7A	4626	02	5959
--------------	------	--------	------	----	------

REDMAX - Tronçonneuses

812 / 814 / G300AVX / G300TS	0,60	BPM6A	7021	08	5063
G2500TS	0,80	BPMR7A	4626	02	5959
G300AVS, G45AVS	0,70	BPMR6A	6726	08	5063
G310TS (n° série -> 002190)	0,60	BPMR7A	4626	02	5959
G3200 (n° série -> 404765)	0,60	BPMR7A	4626	02	5959
G3200EZ (n° série -> 400000)	0,60	BPMR7A	4626	02	5959
G3800AVS (n° série -> 001880)	0,60	BPMR7A	4626	02	5959
G400AVS, G561AVS, G450AVS / G455AVS	0,50	BPMR7A	4626	02	5959
G621AVS Mot. (n° série -> 200100)	0,80	BPM7A	7321	02	5959
GZ3500T	0,60	CMR7H	3066	-	-
GZ3800	0,60	BPMR7A	4626	02	5959
GZ4500	0,60	CMR7H	3066	-	-
GZ5300, GZ7000	0,60	BPMR7A	4626	02	5959

REGENT - Tondeuses

Mot. B&S Vanguard V-Twin 16 / 18hp	0,90	BKR5E	7938	07	4803
------------------------------------	------	-------	------	----	------

REMINGTON - Tondeuses

Tous modèles	0,70	BR2-LM	5798	06	4740
--------------	------	--------	------	----	------

Modèle

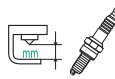
 N° STOCK BOÎTE
 N° STOCK BLISTER
 N° STOCK BLISTER

REMINGTON - Tronçonneuses

305, 340, 380	0,80	BM6A	5921	01	5478
812, 814, 816 / AV, 840AV / 850AV / 860AV	0,70	BPM6A	7021	08	5063
Jobmaster / Yardmaster	0,70	BPM6A	7021	08	5063
Mighty Mite 100 / 200 / 300 / 400 / 500 / 600	0,70	BPM6A	7021	08	5063
Mighty-Mite	0,60	BM7A	6521	10	6793
Mighty-Mite Auto / Deluxe / Bantam / Weekender	0,70	BM7A	6521	10	6793
Mighty-Mite Electric / Super Deluxe / Pow-R-Cut	0,70	BM7A	6521	10	6793
Outdoorsman II	0,70	BPMR6A	6726	08	5063
PL4 / 5 / 6 / 6A / 7 / 7A / 55 / 55A, P5A	0,70	BM7A	6521	10	6793
Pow-R-Cut	0,60	BM7A	6521	10	6793
Rancher / Woodman / Logger, SL 55 / SL55 Auto	0,70	BM7A	6521	10	6793
SL4A / SL7 / SL9 / SL9A / SL9 Deluxe	0,80	BM7A	6521	10	6793
SL10 / SL10A / SL11 / SL11A / SL14 / SL16	0,70	BM7A	6521	10	6793
Sportsman II	0,70	BPMR6A	6726	08	5063
Super 754	0,80	BR6S	3522	09	6048

RICH - Tondeuses

Mot. Kawasaki OHV 17 hp	0,80	BPR5ES	7422	03	6854
Mot. Kohler V-Twin 20/25 hp	0,80	BKR5E	7938	07	4803

RIDE-A-MOWERS - Tondeuses

Tous modèles	0,70	BR2-LM	5798	06	4740
--------------	------	--------	------	----	------

RIGID - Tronçonneuses

305 / 340 / 380 / 390 / 590 / 690 / 850	0,60	BMR6A	7421	01	5478
Lumber Jack	0,80	B6S	3510	09	6048

ROBERTSON - Tondeuses

Tous modèles	0,70	BR2-LM	5798	06	4740
--------------	------	--------	------	----	------

ROBIN-FUJI - Voir FUJI-ROBIN - Débroussailleuses

ROCHER - Tronçonneuses

Rocio 255	0,60	BMR6F	2144	11	7683
-----------	------	-------	------	----	------

ROCKET - Tondeuses

Mot. B&S	0,70	BR2-LM	5798	06	4740
----------	------	--------	------	----	------

ROOF - Tondeuses

Mot. B&S 5 / 8 / 8,5 / 10,5 hp	0,70	BR2-LM	5798	06	4740
Mot. B&S Intek OHV 6 hp / B&S Vanguard 9 hp	0,80	BKR5E	7938	07	4803
Mot. Clinton, Kohler	0,80	B-4	3210	-	-
Mot. Honda OHV 9 hp & Kawasaki OHV 5 / 9 hp	0,80	BPR5ES	7422	03	6854
Mot. Wisconsin	0,80	AB-6	2910	-	-
RidingTractor	0,80	B4-LM	3410	05	4358

ROOT - Tondeuses

RidingTractor	0,80	B6S	3510	09	6048
Tous modèles	0,70	BR2-LM	5798	06	4740

ROOT - Tronçonneuses

C110 / C121	0,60	BM7F	6421	-	-
Lumber Jack	0,80	BR6S	3522	09	6048

ROPER - Tondeuses

Onan B48G, Onan N52	0,60	TR5	2238	-	-
Tous modèles	0,70	BR2-LM	5798	06	4740

ROPER - Tronçonneuses

C110 / C121 / C11047 / C12147	0,60	BM7F	6421	-	-
C332 / C343 / C354 / C33237 / C34337	0,60	BM7A	6521	10	6793
C35427 / C35437, C3327 / AR, C3437 / AR	0,60	BM7A	6521	10	6793
C3427, C3427AR	0,80	BM7A	6521	10	6793
C3637AR	0,60	BM7F	6421	-	-
C6117, C6257 / AR, C6367, C6367AR	0,60	BM7F	6421	-	-
Fendeuse à bois	0,60	BM6A	5921	01	5478
ProAm 412 / 414 / 415	0,60	BM7F	6421	-	-
TTM	0,70	BPM6A	7021	08	5063

Modèle

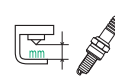
 N° STOCK BOÎTE
 N° STOCK BLISTER
 N° STOCK BLISTER

ROSS - Manutention

Continental	0,60	AB-6	2910	-	-
Hercules - Ø14mm	0,60	B6S	3510	09	6048
Mot. Winconsin	0,60	AB-6	2910	-	-

ROTAX - Générateurs

251	0,50	AB-7	3010	-	-
299	0,50	AB-6	2910	-	-
370	0,50	B7HS	5110	-	-
400, 500, 600, Stamo: 125, 150, 150H	0,50	AB-6	2910	-	-
635	0,50	AB-7	3010	-	-
Stamo: 75	0,50	B5HS	4210	-	-
Stamo: 95	0,50	B6HS	4510	-	-
Stamo: 151	0,50	AB-7	3010	-	-
Stamo: 165, 185, 200, 250, 250AS	0,50	AB-6	2910	-	-

ROTH - Tondeuses

Tous modèles	0,70	BR2-LM	5798	06	4740
--------------	------	--------	------	----	------

ROTO CLIPPER - Tondeuses

Tous modèles	0,70	BR2-LM	5798	06	4740
--------------	------	--------	------	----	------

ROTOMATIC - Tondeuses

Tous modèles	0,70	BR2-LM	5798	06	4740
--------------	------	--------	------	----	------

ROVER - Tondeuses

Mot. B&S 3.75 / 4.5 / 5 / 5.5 hp	0,70	BR2-LM	5798	06	4740
----------------------------------	------	--------	------	----	------

RPM - Tondeuses

Mot. B&S	0,70	BR2-LM	5798	06	4740
Mot. Clinton	0,70	BR6S	3522	09	6048
Mot. Iron Horse	0,60	BR6S	3522	09	6048
Mot. Power Product	0,80	B-4	3210	-	-
Rotoflo	0,80	B2-LM	1147	06	4740

RUGG - Tondeuses

Tous modèles	0,70	BR2-LM	5798	06	4740
--------------	------	--------	------	----	------

RYOBI - Débroussailleuses

2075RC Mot. 25cc, 2079R, 2090R	0,70	BPMR7A	4626	02	5959
2090RC Mot. 31cc	0,50	BPMR6F	1270	-	-
310RT / 330RB / 340RB Mot. 31cc	0,80	BPMR6F	1270	-	-
700R / 704R / 704 RVP / 705R / 710R Mot. 31cc	0,80	BPMR6F	1270	-	-
720R	0,70	BMR6F	2144	11	7683
725R Mot. 31cc, 725RE	0,80	BPMR6F	1270	-	-
740R / 750R / 760R / 765R Mot. 31cc	0,80	BPMR6F	1270	-	-
766R	0,70	BMR6F	2144	11	7683
767R / 767RJ / 768R Mot. 31cc	0,80	BPMR6F	1270	-	-
770R / 775R / 780R Mot. 31cc	0,80	BPMR6F	1270	-	-
790K / 790PR / 790R Mot. 31cc	0,80	BPMR6F	1270	-	-
865R	0,70	BMR6F	2144	11	7683
875R	0,80	BPMR6F	1270	-	-
885R Mot. 31cc	0,50	BPMR6F	1270	-	-
920 / 925R / 960R / 970R / 975R / 990R	0,80	BPMR6F	1270	-	-
PBC 3046YB / 3046YE, PLT 3043YW	0,60	BPMR7A	4626	02	5959
RB 2540 Mot. 25cc	0,60	BPMR7A	4626	02	5959
RBC 254FC	0,70	CMR7A	7543	-	-
RBC 30SBS / 30SES / 40SB / 52SB	0,60	BPMR7A	4626	02	5959
RD 260 / 330 / 420	0,70	BMR6A	7421	01	5478
RLT 30CD / 30CES	0,60	BPMR7A	4626	02	5959

RYOBI - Manutention

Mot. 2 tps	0,50	BPM6F	5950	-	-
------------	------	-------	------	---	---

RYOBI - Outils Divers

PBV 30 / 30 A	0,60	BPMR7A	4626	02	5959
PPW 3000	0,70	BR6HS	3922	-	-
RBL 30 MVA	0,60	BPMR7A	4626	02	5959
RGBV 3100	0,50	BPMR6F	1270	-	-
RHT 2660 DA	0,60	BPMR7A	4626	02	5959

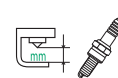
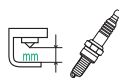

RYOBI - Tronçonneuses

GTS 28 / 32 / 38 / 56 / 62	0,50	BPM7A	7321	02	5959
PCN 3335	0,80	BPMR7A	4626	02	5959
RCS 3540 C / 4046 C / 4450 C	0,60	CMR7H	3066	-	-
RGS 3214 / 3214 A / 3816 / 4518 / 5418	0,50	BPM7A	7321	02	5959

RYONO - Tronçonneuses

1.9PS	0,70	BM6A	5921	01	5478
-------	------	------	------	----	------

SABO - Générateurs

SB 135L / 140 SL	0,60	BP-4	2911	-	-
SB 152	0,70	B5HS	4210	-	-

SABO - Tondeuses

37-2TH - Mot. Robin EC 04-3V	0,70	BR6HS	3922	-	-
38-EV - Mot. B&S, 47-4 BCA	0,70	BR4-LM	4133	05	4358
43-130 / H - Mot. F&S SB130	0,60	BP-4	2911	-	-
43-130 H m.a. Mot. F&S SB130	0,60	BP-4	2911	-	-
43-190 - Mot. B&S Quantum 4,5 hp	0,60	BR2-LM	5798	06	4740
43-2TH - Mot. Suzuki V140X	0,70	BPMR4A	6028	-	-
43-4 / A / EA, 43 S-4 / A	0,60	BR2-LM	5798	06	4740
43-4 TE / TH m.a. Mot. B&S 3 hp	0,60	BR2-LM	5798	06	4740
43-4TH - Mot. B&S 3 hp	0,60	BR2-LM	5798	06	4740
43-4THE - Mot. Tecna BV153ES	0,60	BR6S	3522	09	6048
43-4THE m.a. Mot. Tecna BV153ES	0,60	BR6S	3522	09	6048
43-4TS - Mot. B&S 3 hp	0,60	BR2-LM	5798	06	4740
43-4TSH m.a. - Mot. Suzuki V140X	0,80	BPR6ES	7822	04	7678
43-96 / H - Mot. F&S SB93	0,70	B-4H	4110	-	-
43-OHV / A, 47-OHV / E A	0,70	BPR5ES	7422	03	6854
43-QHE m.a. Mot. B&S Quantum 3.5 hp, 47 Kat A	0,60	BR2-LM	5798	06	4740
47-2A - Mot. F&S SB140SL	0,60	BP-4	2911	-	-
47-4 / A / EA Mot. B&S XM40	0,60	BR2-LM	5798	06	4740
47-4 Kat A, 50-4 TH/TL, 52-4 TL	0,60	BR2-LM	5798	06	4740
47-OHV / A / EA - Mot. B&S Europa OHV	0,70	BR6ES	4922	-	-
47-OHV A / 47-OHVE A	0,80	BPR5ES	7422	03	6854
50-126 / H m.a. - Mot. F&S SB126	0,60	B5HS	4210	-	-
50-4 TH / TL - Mot. B&S 3.5 HP	0,60	BR2-LM	5798	06	4740
50-4 TH / TL m.a. Mot. B&S 3.5 HP	0,60	BR2-LM	5798	06	4740
51-140H / 52-140 H Mot. F&S SB140	0,60	BP-4	2911	-	-
52-140 m.a. Mot. F&S SB140	0,60	BP-4	2911	-	-
52-152 / H m.a.	0,60	B5HS	4210	-	-
52-4 TL m.a.	0,60	BR2-LM	5798	06	4740
52-OHV A	0,80	BPR5ES	7422	03	6854
76-320	0,60	BMR6A	7421	01	5478
Clipper 52	0,70	BCPR5ES	6130	07	4803

SABRE - Débroussailleuses

B25, S25, S25C	0,60	BPM6F	5950	-	-
----------------	------	-------	------	---	---

SABRE - Tondeuses

1338 / 1538 / 1546 / 1646, 1438GS / 1538GS-HS	0,80	BCPR5ES	6130	07	4803
1542GS-HS / 1642GS-HS / 1646HS / 1642HV	0,80	BCPR5ES	6130	07	4803
1646HV / 1642HV / 1646HV / 1842GV / 1842HV	0,80	BCPR5ES	6130	07	4803
2048HV / 2254HV / 2554HV	0,80	BCPR5ES	6130	07	4803
M10 / M21 / M23, Mot. B&S 5.5 / 6 hp	0,70	BR2-LM	5798	06	4740
Mot. B&S Intek V-Twin 22 hp	0,80	BCPR5ES	6130	07	4803
Mot. B&S OHV 13 / 14 / 15 hp	0,80	BCPR5ES	6130	07	4803
Mot. B&S Vanguard V-Twin 16 / 18 / 20 hp	0,80	BCPR5ES	6130	07	4803
Mot. Honda GV 400 11 hp	0,60	BMR6A	7421	01	5478
Mot. Kohler V-Twin 25 hp	0,80	BCPR5ES	6130	07	4803
Trike 31 & 42 Mot. B&S 8 hp	0,60	BMR6A	7421	01	5478

SACHS - Débroussailleuses

Mot. Kawasaki	0,70	BM6A	5921	01	5478
---------------	------	------	------	----	------

SACHS - Tondeuses

SB 130 / 140	0,70	BR2-LM	5798	06	4740
ST 204 / 251 / 282	0,50	AB-6	2910	-	-
ST 96 / 151	0,50	B6HS	4510	-	-

SACHS-DOLMAR - Voir DOLMAR - Gén.

SALSBURY - Manutention

Tous modèles	0,60	AB-6	2910	-	-
--------------	------	------	------	---	---

SARLO - Tondeuses

1026-3SPSW Mot. B&S OHV 11.5 hp	0,70	BKR5ES	2460	07	4803
1026SS Mot. B&S OHV 11.5 hp	0,70	BKR5ES	2460	07	4803
1030-3SPSW Mot. B&S OHV 11.5 hp	0,70	BKR5ES	2460	07	4803
Mot. B&S 5 / 5.5 / 8 / 8.5 / 10.5 / 12.5 hp	0,70	BR2-LM	5798	06	4740
Mot. B&S I/C 10.5 hp	0,70	BR2-LM	5798	06	4740
Mot. B&S Intek 7 / 11 hp	0,70	BKR5ES	2460	07	4803
Mot. B&S OHV 6.75 hp	0,80	BKR5E	7938	07	4803
Mot. B&S Quantum 6 hp	0,70	BR2-LM	5798	06	4740
Mot. Honda OHV 4 / 13 hp	0,80	BPR5ES	7422	03	6854
Mot. Honda OHV 5 hp	0,80	BPR6ES	7822	04	7678
Mot. Kawasaki OHV 9 / 9.5 hp	0,80	BPR5ES	7422	03	6854
Mot. Kohler	0,80	B2-LM	1147	06	4740
Mot. Kohler K181 4 / 8 hp	0,70	BR2-LM	5798	06	4740
SST6 / SST6SP Mot. B&S 6-6.75 hp	0,70	BKR5ES	2460	07	4803
WX24SP. 621-2 Mot. B&S 6-6.75 hp	0,70	BKR5ES	2460	07	4803

SARP - Débroussailleuses

VS 200B / 200S, 250S, 330T, 430T, 480T	0,70	BM6A	5921	01	5478
VS 250HS / 331HT	0,70	CR5HSB	6535	-	-
VS 250MS / 250MT	0,70	BMR6A	7421	01	5478

SATURN - Tondeuses

Mot. Tecumseh 5 hp	0,80	BMR6A	7421	01	5478
--------------------	------	-------	------	----	------

SAVAGE - Tondeuses

Mot. B&S	0,70	BR2-LM	5798	06	4740
Mot. Clinton 2 tps	0,60	BM4A	5628	-	-
Mot. Clinton 4 tps, Mot. Lauson	0,70	BR6S	3522	09	6048
Mot. Power Product	0,70	BR6S	3522	09	6048

SCAG - Tondeuses

Mot. B&S 11 / 12 hp	0,70	BR2-LM	5798	06	4740
Mot. B&S 16 / 18 / 20 hp Vanguard V-Twin	0,80	BCPR5ES	6130	07	4803
Mot. B&S 18 hp Twin	0,70	BR2-LM	5798	06	4740
Mot. B&S 26 hp	0,70	BKR5ES	2460	07	4803
Mot. B&S 31 h. Vanguard (Refr. Liquide)	0,60	BCPR5ES	6130	07	4803
Mot. Honda GXV 670 24 hp	0,70	ZGR5A	5839	-	-
Mot. Honda GXV530 16hp / GXV610 18hp	0,80	BPR5ES	7422	03	6854
Mot. Kawasaki 12.5 hp	0,70	BM6A	5921	01	5478
Mot. Kawasaki 14 hp	0,60	B5HS	4210	-	-
Mot. Kawasaki 16 hp	0,60	BMR6A	7421	01	5478
Mot. Kawasaki 17 hp	0,60	BPMR6A	6726	08	5063
Mot. Kawasaki 19 : 21 hp	0,70	BPR4ES	7222	-	-
Mot. Kawasaki 26 hp	0,60	BPR2ES	2264	-	-
Mot. Kawasaki 27 hp	0,80	BPR5ES	7422	03	6854
Mot. Kawasaki 29 hp	0,70	BPR4ES	7222	-	-
Mot. Kawasaki V-Twin (Refr. Liquide) 27 hp	0,60	BP5ES	6511	03	6854
Mot. Kawasaki V-Twin 17, 19, 21, 23 hp	0,80	BP5ES	6511	03	6854
Mot. Kawasaki V-Twin 22 hp	0,70	BM6A	5921	01	5478
Mot. Kawasaki V-Twin OHV 23 / 25 hp	0,70	BPR4ES	7222	-	-
Mot. Kohler 15 hp	1,10	BKR5ES-11	2382	-	-
Mot. Kohler 18 / 30 hp	0,70	BKR5ES	2460	07	4803
Mot. Kohler Aegis 23 hp	0,80	BCPR5ES	6130	07	4803
Mot. Kohler Command V-Twin 27 hp	0,70	BKR5ES	2460	07	4803
Mot. Kohler Command V-Twin OHV 23 hp	0,70	BKR5ES	2460	07	4803
Mot. Kohler OHV 6, 12.5, 13, 14, 15 hp	0,80	BCPR5ES	6130	07	4803
Mot. Kohler Twin 18 & 20 hp	0,60	BPR4FS	1127	-	-
Mot. Kohler V-Twin 18, 20, 22, 23, 25 hp	0,80	BCPR5ES	6130	07	4803

SCHWEISS MAGNUM I - Tondeuses

Tous modèles	0,70	BR6S	3522	09	6048
--------------	------	------	------	----	------

SCHWEISS - Tondeuses

Mot. Kohler Command OHV 25 hp	0,70	BKR5ES	2460	07	4803
-------------------------------	------	--------	------	----	------

Modèle

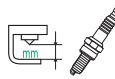
 N° STOCK
BLISTER
BOÎTE

SCOOT-CRETE - Manutention

Mot. Kohler 18 / 20 hp	0,70	B-6L	3212	-	-
Mot. Kohler K181 8 hp	0,80	B2-LM	1147	06	4740
Mot. Winconsin ANLD, TJD	0,70	AB-6	2910	-	-

SCOTTS - Tondeuses

F2105-040, F2155-050, F2155-150	0,70	BR2-LM	5798	06	4740
Mot. B&S "L" Head 3 / 3.5 / 4 / 4.5 / 5 / 5.5 hp	0,70	BR2-LM	5798	06	4740
Mot. B&S Intek OHV 6.5 hp	0,70	BKR5ES	2460	07	4803
Mot. B&S OHV 5 hp	0,80	BKR5E	7938	07	4803
Mot. Honda OHV 5 hp	0,80	BPR6ES	7822	04	7678

SCYTHETTE - Tondeuses

Tous modèles	0,70	BR6S	3522	09	6048
--------------	------	-------------	-------------	-----------	-------------

SEARS - Voir CRAFTSMAN - Débroussailleuses

SECO - Manutention

Fire Truck	0,70	AB-6	2910	-	-
------------	------	-------------	-------------	---	---

SENTINEL - Tondeuses

Mot. B&S 3.5 / 3.75 / 4 / 5 hp	0,70	BR2-LM	5798	06	4740
--------------------------------	------	---------------	-------------	-----------	-------------

SHINDAIWA - Débroussailleuses

22-DH Mot. 21.1cc	0,70	BM6A	5921	01	5478
22F / 22 T Mot. 21.1cc	0,60	BM6A	5921	01	5478
AH 230 / 231 (Articulé) Mot. 22.5cc	0,70	BM6A	5921	01	5478
AH 242 Mot. 23.9cc	0,60	BPMR8Y	2218	-	-
AH 254 (Articulé) Mot. 24.5cc	0,70	CMR5H	7599	-	-
AHS 242 Mot. 23.9cc	0,60	BPMR8Y	2218	-	-
AHS 254 (Articulé) Mot. 24.5cc	0,70	CMR5H	7599	-	-
B 40 Mot. 39.4cc, B 45 / B 450 Mot. 41.5cc	0,60	BM6A	5921	01	5478
B 530	0,70	BM6A	5921	01	5478
BP 23E	0,70	BMR6A	7421	01	5478
BP 25 Mot. 24.1cc, BP 35 Mot. 33.6cc	0,60	BM6A	5921	01	5478
BP 450	0,70	BMR6A	7421	01	5478
C 20 Mot. 21.1cc	0,60	BM6A	5921	01	5478
C 23	0,70	BMR6A	7421	01	5478
C 25 Mot. 24.1cc, C 27 Mot. 27.2cc	0,60	BM6A	5921	01	5478
C 35 Mot. 33.6cc	0,60	BM6A	5921	01	5478
C 220	0,70	BMR6A	7421	01	5478
C 230 Mot. 22.5cc, C 250 Mot. 24.1cc	0,60	BM6A	5921	01	5478
C 254 Mot. 25.5cc	0,70	CMR5H	7599	-	-
C 260 Mot. 24.1cc, C 270 Mot. 27.2cc	0,60	BPM6A	7021	08	5063
C 282 Mot. 28.9cc, C 300	0,60	BPMR6A	6726	08	5063
C 3410, C 344 Mot. 34cc	0,70	CMR5H	7599	-	-
C 350 Mot. 33.6cc	0,60	BM6A	5921	01	5478
C 2500 / 2510	0,70	CMR5H	7599	-	-
DH 230 Mot. 22.5cc, DH 230-30, DH 230-40	0,60	BM6A	5921	01	5478
DH 231 Mot. 22.5cc	0,60	BM6A	5921	01	5478
DH 232-24 Mot. 21.2cc, DH 232-30 Mot. 21.2cc	0,60	BPMR8Y	2218	-	-
DH 254-24 Mot. 24.5cc, DH 254-30 Mot. 24.5cc	0,70	CMR5H	7599	-	-
DYB 190 / 191 / 200->202/251->254/345/351	0,60	BMR6A	7421	01	5478
F 18 Mot. 18.4cc, F 20 Mot. 19.8cc	0,60	BM6A	5921	01	5478
F 21 Mot. 21.1cc	0,60	BM6A	5921	01	5478
F 220, F 230 Mot. 22.5cc	0,70	BM6A	5921	01	5478
HT 20 Mot. 21.1cc, HT 30	0,70	BM6A	5921	01	5478
HT 230 Mot. 22.5cc, HT 231 Mot. 22.5cc	0,70	BM6A	5921	01	5478
HT 232-30 Mot. 21.2cc, HT 232-40 Mot. 21.2cc	0,60	BPMR8Y	2218	-	-
HT 254-30 Mot. 24.5cc, HT 254-40 Mot. 24.5cc	0,70	CMR5H	7599	-	-
HT 2020, HT 2030	0,60	BM6A	5921	01	5478
LE 230 / 231, LE 250	0,60	BMR6A	7421	01	5478
LE 254 Mot. 24.5cc	0,70	CMR5H	7599	-	-
LE 260 / 261	0,50	BPMR6A	6726	08	5063
LT 20 Mot. 33.6cc	0,60	BM6A	5921	01	5478
M 2500 / 2510	0,60	CMR6H	3365	12	4794
RC 45 Mot. 41.5cc	0,60	BM6A	5921	01	5478
RH 20	0,70	BM6A	5921	01	5478
T 18 Mot. 18.4cc	0,60	BM6A	5921	01	5478
T 20 Mot. 21.1cc	0,60	BM6A	5921	01	5478
T 22F / 22T, T 23, T 23E	0,70	BMR6A	7421	01	5478
T 25 Mot. 24.1cc	0,60	BM6A	5921	01	5478

Modèle

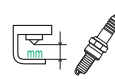
 N° STOCK
BLISTER
BOÎTE

T 27 Mot. 27.2cc	0,60	BPM6A	7021	08	5063
T 195	0,70	BPMR8Y	2218	-	-
T 210 / 220	0,60	BMR6A	7421	01	5478
T 242 Mot. 23.9cc, T 242X Mot. 23.9cc	0,60	BPMR6A	6726	08	5063
T 230 Mot. 22.5cc, T 231 Mot. 22.5cc	0,60	BM6A	5921	01	5478
T 235 Mot. 21.2cc	0,60	BPMR8Y	2218	-	-
T 250 Mot. 24.1cc	0,60	BM6A	5921	01	5478
T 254 Mot. 24.5cc	0,60	CMR5H	7599	-	-
T 260 Mot. 24.1cc	0,60	BPM6A	7021	08	5063
T 260X	0,70	BPMR6A	6726	08	5063
T 261 Mot. 24.1cc	0,60	BPM6A	7021	08	5063
T 270 Mot. 27.2cc, T 272X Mot. 27.2cc	0,60	BPM6A	7021	08	5063
T 282 Mot. 28.8cc, T 282X Mot. 28.8cc	0,60	BPMR6A	6726	08	5063
T 300	0,70	BPMR6A	6726	08	5063
T 3410 / 3410X	0,70	CMR5H	7599	-	-
T 350 Mot. 33.6cc	0,60	BM6A	5921	01	5478
T 450	0,70	BMR6A	7421	01	5478
T 344 Mot. 34cc	0,70	CMR5H	7599	-	-
T 2500 Mot. 24.5cc, T 2500X	0,60	CMR6H	3365	12	4794
T 2510 / 2510X	0,70	CMR5H	7599	-	-
TYB 210	0,70	BM6A	5921	01	5478

SHINDAIWA - Générateurs

B 45 / 450	0,70	BMR6A	7421	01	5478
BP 20 / 25 / 30FL / 40FL	0,70	BM6A	5921	01	5478
BP 35 / 45	0,70	BMR6A	7421	01	5478
C 20 / 25	0,70	BM6A	5921	01	5478
C 23 / 35 / 230 / 250 / 350	0,70	BMR6A	7421	01	5478
C 27 / 260 / 270	0,70	BPMR6A	6726	08	5063
DYB 190 / 191 / 200->202 / 251->254 / 345 / 351	0,70	BM6A	5921	01	5478
EB 240 / 480	0,70	BM6A	5921	01	5478
EB 8510	0,60	CMR5H	7599	-	-
EC3 50, CYB 350	0,70	BPM6A	7021	08	5063
EK 23S	0,70	BM6A	5921	01	5478
F 18	0,70	BMR6A	7421	01	5478
F 20 / 21	0,70	BM6A	5921	01	5478
F 220 / 230	0,70	BMR6A	7421	01	5478
G 1000 / 2000 / 3000	0,60	BR6HS	3922	-	-
G 4000	0,60	BP4HS	3611	-	-
GP 10 / 25 / 45 / 401 / 450	0,70	BM6A	5921	01	5478
HT 2020 / 2030	0,60	BM6A	5921	01	5478
LE 260	0,70	BPM6A	7021	08	5063
R 18 / 20 / 24 / 25 / 26 / 30FL / 35 / 35F / 40FL	0,70	BM6A	5921	01	5478
R 230 / 250 / 250F	0,70	BM6A	5921	01	5478
R 232 / 234 / 251, R 26-2A	0,70	BPM6A	7021	08	5063
RE 18 / 20 / 21, RK 20F / 25F / 35F	0,70	BM6A	5921	01	5478
RM 35 / 45 / 350, T 18 / 20 / 25	0,70	BM6A	5921	01	5478
T 23 / 35 / 220 / 230 / 250 / 260 / 350 / 450	0,70	BMR6A	7421	01	5478
T 27	0,70	BPMR6A	6726	08	5063
T 270	0,70	BPM6A	7021	08	5063
T 300	0,70	BPMR6A	6726	08	5063

SHINDAIWA - Tondeuses

EC350 / R232	0,70	BPM6A	7021	08	5063
--------------	------	--------------	-------------	-----------	-------------

SHINDAIWA - Tronçonneuses

300 / 345 / 350	0,60	BPMR6A	6726	08	5063
355	0,70	BPMR6A	6726	08	5063
357	0,80	BPMR7A	4626	02	5959
416 / 451 / 500	0,60	BPMR6A	6726	08	5063
510	0,70	BPMR6A	6726	08	5063
575	0,60	BPMR6A	6726	08	5063
680	0,70	BPMR6A	6726	08	5063
695	0,60	BPMR6A	6726	08	5063
101 - Mot. 25cc	0,70	BPMR6A	6726	08	5063
300S	0,60	BPMR6A	6726	08	5063
300S - Mot. 1.7 ci. 28.5cc	0,80	BPM7A	7321	02	5959
300VK, 352s, 385s, 446s / EPA	0,80	BPMR7A	4626	02	5959
345 - Mot. 2.1 ci. 33.6cc, 350 - Mot. 2.2 ci. 35.5cc	0,70	BPM6A	7021	08	5063
357 - Mot. 2.2 ci. 35.5cc	0,80	BPM7A	7321	02	5959
360 - Mot. 2.1 ci. 35.2cc, 377 - Mot. 2.3 ci. 37.7cc	0,80	BPMR7A	4626	02	5959
400 / 410 / 415 / 420	0,70	BPMR6A	6726	08	5063
416 - Mot. 2.4 ci. 39.4cc	0,70	BPM6A	7021	08	5063
440 / 450 / 460 / 488	0,70				

Modèle

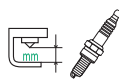

N° STOCK N° BLISTER N° STOCK
BOÎTE BLISTER

488, 488P Mot. 2.9 ci. 47.8cc	0,70	BPM7A	7321	02	5959
500 - Mot. 2.9 ci. 47.8cc	0,70	BPM6A	7021	08	5063
575 / 577 - Mot. 3.5 ci. 57.3cc	0,70	BPM7A	7321	02	5959
577P, 580 (-87) / 685 (-87)	0,70	BPMR6A	6726	08	5063
580 (88-) / 685 (88-)	0,80	BPMR7A	4626	02	5959
695 - Mot. 4.1 ci. 67.9cc	0,70	BPM7A	7321	02	5959
757 / EPA	0,70	BPMR6A	6726	08	5063
757, 757C Mot. 4.5 ci. 73.5cc	0,80	BPM7A	7321	02	5959
CYB 350	0,70	BPMR6A	6726	08	5063
DBY 354 / 453	0,70	BMR6A	7421	01	5478
DYB 190/191/200 -> 202/251-> 254/345/351	0,70	BMR6A	7421	01	5478
E269T	0,80	BPMR7A	4626	02	5959
E300, E300 VK-12	0,70	BPMR6A	6726	08	5063
E300S, E303	0,80	BPM7A	7321	02	5959
E345, E350	0,70	BPM6A	7021	08	5063
E352	0,80	BPM7A	7321	02	5959
E360 / VK	0,80	BPMR7A	4626	02	5959
E380 / E381, E393	0,80	BPM7A	7321	02	5959
E406 / E440	0,70	BPM6A	7021	08	5063
E440D	0,80	BPM7A	7321	02	5959
E480	0,70	BPM6A	7021	08	5063
E580 (-87)	0,70	BPMR6A	6726	08	5063
E580 (88-)	0,80	BPMR7A	4626	02	5959
E680 (->87)	0,70	BPMR6A	6726	08	5063
E680 (88-)	0,80	BPMR7A	4626	02	5959
E680AV	0,70	BPM6A	7021	08	5063
E680EV	0,70	BPMR6A	6726	08	5063
E757	0,80	BPM7A	7321	02	5959
EC350	0,70	BPM6A	7021	08	5063
EC7500 / 7600 - Mot. 4.5 ci. 73.5cc	0,70	BPM7A	7321	02	5959
F685 / K35	0,80	BPM7A	7321	02	5959
YB 801 (-87)	0,70	BPMR6A	6726	08	5063
YB 801 (88-)	0,80	BPMR7A	4626	02	5959
YB291	0,70	BPMR6A	6726	08	5063
YB301, YB401, YB501, YB601, YB701, YB901	0,70	BPM6A	7021	08	5063
YB591	0,70	BPMR6A	6726	08	5063

SHOP MULE - Manutention

A3V, A3VU2, A14V, A21	0,60	AB-6	2910	-	-
J233, J233PLD	0,60	B2-LM	1147	06	4740
Spotter	0,60	B6S	3510	09	6048
Mot. Chrysler HB225	0,90	UR4	6630	-	-
Mot. Chrysler LH318	0,90	BPR4ES	7222	-	-

SIGMA - Tondeuses

Mot. B&S 3 / 3.5 hp	0,70	BR2-LM	5798	06	4740
Mot. Kawasaki OHV 4.5 / 5 hp	0,80	BPR5ES	7422	03	6854
Mot. Tecumseh 3 hp	0,70	BR2-LM	5798	06	4740
Mot. Tecumseh 7 hp	0,70	BR6S	3522	09	6048

SILENT HOIST - Manutention

A, AJ, AN	0,60	AB-6	2910	-	-
AX, AY, AZ, CDH	0,60	B6S	3510	09	6048
AXH, AYH, AZH	0,60	AB-6	2910	-	-
CD - Ø14mm	0,60	BR6S	3522	09	6048
CD - Ø18mm	0,60	AB-6	2910	-	-
CDY - Ø14mm	0,60	B6S	3510	09	6048
CDY - Ø18mm	0,60	AB-6	2910	-	-
FK, FK-3 / -10 - Ø14mm	0,60	B6S	3510	09	6048
FK, FK-3 / -5 / -6 / -10 - Ø18mm	0,60	AB-6	2910	-	-
FK-5 / -6 - Ø14mm	0,60	BR6S	3522	09	6048
FK-71/2, FK-8 / 12 / 15	0,60	B6S	3510	09	6048
IND-30, 31, 33 - Mot. Chrysler	0,60	BR6S	3522	09	6048
Modèle 20	0,60	AB-6	2910	-	-

SIMPLICITY - Débroussailleuses

GM2513BS Mot. B&S 13 hp	0,70	BKR5ES	2460	07	4803
GM2515KAWW Mot. Kawasaki V-Twin 15 hp	0,60	BCPR6ES	2330	-	-

SIMPLICITY - Tondeuses

Broadmoor - Mot. B&S 14 / 15 / 16 / 17 hp	0,70	BKR5ES	2460	07	4803
Broadmoor - Mot. B&S Vanguard 18 hp	0,70	BKR5ES	2460	07	4803
Broadmoor - Mot. Kohler 16 hp	0,70	BKR5ES	2460	07	4803

Modèle

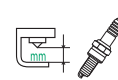

N° STOCK N° BLISTER N° STOCK
BOÎTE BLISTER

Broadmoor - Mot. Kohler Command 18 hp	0,70	BKR5ES	2460	07	4803
Broadmoor - Mot. Kohler CV14S 14 hp	1,00	BKR5ES-11	2382	-	-
Colt - Mot. Kohler Command 23 hp	0,70	BKR5ES	2460	07	4803
Conquest - Mot. B&S Intek V-Twin 22 hp	0,70	BKR5ES	2460	07	4803
Conquest / ConsumerZ - Mot. B&S Vanguard 20 hp	0,70	BKR5ES	2460	07	4803
ConsumerZ - Mot. Kohler Command 18 hp	0,70	BKR5ES	2460	07	4803
Coronet - Mot. B&S 10.5 / 12.5 / 13 hp	0,70	BR2-LM	5798	06	4740
Coronet - Mot. B&S 8.5 hp	0,60	B2-LM	1147	06	4740
Coronet - Mot. Kohler 16 hp	0,70	BKR5ES	2460	07	4803
Coronet - Mot. Kohler CV12.5S 12.5 hp	1,00	BKR5ES-11	2382	-	-
Coronet - Mot. Kohler CV14S 14 hp	1,00	BKR5ES-11	2382	-	-
Coronet - Mot. Tecumseh OHV125 12.5 hp	0,80	BR7ES	5122	-	-
Javelin - Mot. B&S V-Twin 22 hp	0,70	BKR5ES	2460	07	4803
Lancer - Mot. B&S 17 hp	0,70	BKR5ES	2460	07	4803
Landlord - Mot. B&S 16 / 18 / 20 hp	0,70	BKR5ES	2460	07	4803
Landlord - Mot. Kawa. (Ref. Liquide) 17 hp	0,80	BMR6A	7421	01	5478
Legacy - Mot. Kawasaki 20 hp	1,00	BMR2A-10	4452	-	-
Legacy - Mot. Kawasaki 27 hp	0,80	BPR2ES	2264	-	-
Legacy - Mot. Kohler 20 / 25 / 27 hp	0,70	BKR5ES	2460	07	4803
Morgan - Mot. B&S Vanguard 20 hp	0,70	BKR5ES	2460	07	4803
Mot. B&S 5 hp	0,60	B2-LM	1147	06	4740
Mot. B&S Vanguard 20 / 21 / 23 hp	0,70	BKR5ES	2460	07	4803
Mot. Kohler Command 27 hp	0,70	BKR5ES	2460	07	4803
Mot. Kohler Command V-Twin 18 / 20 hp	0,70	BKR5ES	2460	07	4803
Mot. Kohler Courage 20 hp	0,70	BKR5ES	2460	07	4803
Mot. Kohler KT17 17 hp	0,60	UR4	6630	-	-
PowerSteering - Mot. Kohler 18 hp	0,70	BKR5ES	2460	07	4803
Prestige - Mot. Kohler 20 / 23 hp	0,70	BKR5ES	2460	07	4803
Regent - Mot. B&S 15 / 17 hp	0,70	BKR5ES	2460	07	4803
Regent - Mot. B&S 289707 12.5 hp	0,70	BR2-LM	5798	06	4740
Regent - Mot. B&S Intek OHV 18 hp	0,70	BKR5ES	2460	07	4803
Regent - Mot. B&S Vanguard 18 hp	0,70	BKR5ES	2460	07	4803
Regent - Mot. Kohler 16 hp	0,70	BKR5ES	2460	07	4803
Regent - Mot. Kohler Command 18 hp	0,70	BKR5ES	2460	07	4803
Regent - Mot. Kohler CV14S 14 hp	1,00	BKR5ES-11	2382	-	-
Serf	0,60	BM6A	5921	01	5478
Sovereign - Mot. Kohler 18 hp	0,70	BKR5ES	2460	07	4803
Sovereign Anniversary - Mot. Kohler 18 hp	0,70	BKR5ES	2460	07	4803
Stallion - Mot. Kohler Command OHV 25 hp	0,70	BKR5ES	2460	07	4803
Sunstar - Mot. B&S 18 hp	0,70	BKR5ES	2460	07	4803
Sunstar - Mot. Kohler 20 hp	0,70	BKR5ES	2460	07	4803
ZeroTurnforHomeowners B&S Vang. 20hp	0,70	BKR5ES	2460	07	4803
ZeroTurnforHomeowners Kohler CV14S 14hp	1,00	BKR5ES-11	2382	-	-
ZeroTurnforHomeowners Mot. B&S 18hp	0,70	BKR5ES	2460	07	4803
ZeroTurnforHomeowners Mot. Kohler 16 / 18hp	0,70	BKR5ES	2460	07	4803

SKIL - Générateurs

Alternateur - Mot. B&S	0,60	B2-LM	1147	06	4740
Alternateur, Générateur, Vibreur - Ø14mm	0,60	BM6A	5921	01	5478
Alternateur, Générateur, Vibreur - Ø18mm	0,60	AB-6	2910	-	-

SKIL - Tronçonneuses

1610, 1611, 1612, 1613, 1614, 1616, 1705, 1712	0,60	BMR6F	2144	11	7683
1620, 1622, 1624	0,70	BMR6A	7421	01	5478
1629, 1630, 1631, 1644	0,80	BR6S	3522	09	6048
1634, 1636, 255	0,70	BMR6A	7421	01	5478
1641	0,70	BPMR6A	6726	08	5063
1645, 1660, 1661, 1690	0,80	BR6S	3522	09	6048
933, 944, 946, 947, Partner Mini III, IV	0,60	BMR6F	2144	11	7683

SMC - Tondeuses

Mot. Kawasaki	0,80	BM7A	6521	10	6793
Mot. Kioritz	0,80	BMR6A	7421	01	5478

SMITHCO - Tondeuses

Mot. B&S Mot. Kohler K181 8 hp	0,70	BR2-LM	5798	06	4740
Mot. Tecumseh	0,70	BR6S	3522	09	6048

SNAPPER - Débroussailleuses

ETC 302 KW	0,60	BM6A	5921	01	5478
Mot. B&S 13 hp	0,70	BKR5ES	2460	07	4803
Mot. Kohler Command 15 hp	1,00	BKR5ES-11	2382	-	-

Modèle

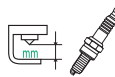
 N° STOCK BOÎTE
 N° BLISTER
 N° STOCK BLISTER

SNAPPER - Générateurs

EGT 180H335K / 180H425K	0,70	BPR4FS	1127	-	-
ELT 125D331V / 125G331KV	0,70	BCPR5ES	6130	07	4803
ELT 125G33BB / 125G38AB	0,70	BR2-LM	5798	06	4740
ELT 140H22BBU / 140H331KV	0,70	BCPR5ES	6130	07	4803
G 10000 - Mot. Mitsubishi OHV 2.4 hp	0,60	BPR6HS	7022	-	-
G 30000 - Mot. B&S OHV 6.5 hp	0,70	BKR5E	7938	07	4803
G 55000 - Mot. B&S Intek OHV 10 hp	0,70	BKR5E	7938	07	4803
IRS 002B	0,70	B2-LM	1147	06	4740
LE 317R	0,70	BPMR6A	6726	08	5063
PP 71402KV	0,70	BCPR5ES	6130	07	4803
PR 3001B	0,70	BM6A	5921	01	5478
PR 5001B, PP 5001B, P 5001B	0,70	B2-LM	1147	06	4740
R 8002B	0,70	BR2-LM	5798	06	4740
W 361252KW / 481252KW	0,70	BMR4A	5728	-	-

SNAPPER - Tondeuses

E 331413KVE / 421613BUE / ECP2155OV	0,80	BCPR5ES	6130	07	4803
E250813B, 250813B / E, E281013BE, E281213BE	0,60	BR2-LM	5798	06	4740
ECP 21400R2 / EC 13V	0,60	BM6A	5921	01	5478
ELW 400 / EP 21400 / 21500 / 2150E	0,60	B2-LM	1147	06	4740
EP 2500W / EX 21500 / EXP 21500	0,60	BR2-LM	5798	06	4740
EXP 21501KWV / ECP 21500KWV	0,80	BPR5ES	7422	03	6854
EY 15V / 20V	0,70	BM4A	5628	-	-
EY 45V	0,70	BPM6A	7021	08	5063
Mot. B&S, Mot. B&S 5 hp	0,70	BR2-LM	5798	06	4740
Mot. B&S Intek 6.5 hp, Mot. B&S Intek OHV 7 hp	0,70	BKR5ES	2460	07	4803
Mot. B&S Quantum 6 / 6.75 hp	0,70	BR2-LM	5798	06	4740
Mot. B&S Vanguard V-Twin 21 hp	0,80	BKR5E	7938	07	4803
Mot. B&S V-Twin ELS OHV 18 / 20 hp	0,80	BKR5E	7938	07	4803
Mot. Honda	0,70	BR6HS	3922	-	-
Mot. Honda GV150	0,70	BR4HS	3322	-	-
Mot. Honda GV35	0,60	B6HS	4510	-	-
Mot. Honda OHV 5 / 5.5 hp, Mot. Kawasaki	0,80	BPR5ES	7422	03	6854
Mot. Kawasaki 12.5 hp	0,70	BMR4A	5728	-	-
Mot. Kawasaki OHV 12.5 hp	0,80	BMR6A	7421	01	5478
Mot. Kawasaki OHV 15 hp	0,90	BCPR6ES	2330	-	-
Mot. Kawasaki OHV 5 / 5.5 / 14 / 17 hp	0,80	BPR5ES	7422	03	6854
Mot. Kawasaki OHV FC180V 6 hp	0,80	BPR5ES	7422	03	6854
Mot. Kawasaki OHV V-Twin 13 hp	0,90	BCPR6ES	2330	-	-
Mot. Kohler OHV 15 hp	0,70	BKR5ES	2460	07	4803
Mot. Kohler OHV 18 hp	0,80	BKR5E	7938	07	4803
Mot. Robin OHV 6 / 6.5 hp	0,70	BR6HS	3922	-	-
Mot. Tecumseh	0,70	BR6S	3522	09	6048
S21 / SP21 - Mot. B&S Quantum 6.5 hp	0,70	BR2-LM	5798	06	4740
SPV21 / S / E - Mot. B&S Quantum 6.5 hp	0,70	BR2-LM	5798	06	4740

SNAPPIN TURTLE - Tondeuses

Culasse Ø14 mm	0,70	BR2-LM	5798	06	4740
Culasse Ø18 mm	0,80	AB-6	2910	-	-

SOLO - Débroussailleuses

117	0,60	BPMR7A	4626	02	5959
123 / 125	0,50	BM6F	6221	11	7683
129	0,70	BPMR7A	4626	02	5959
132	0,70	BPMR6A	6726	08	5063
104-L Mot. 29cc	0,60	BPMR7A	4626	02	5959
105 L, 106 B / L	0,50	BPMR6A	6726	08	5063
106 R	0,60	CMR6A	1223	-	-
109-L, 109-B, 109-LG Mot. 29cc, 118 Mot. 25cc	0,60	BPMR7A	4626	02	5959
119 B / L, 119 Mot. 25cc, 120 Mot. 25cc	0,60	BPMR7A	4626	02	5959
121 / B / L	0,70	BPMR7A	4626	02	5959
124 Mot. 25cc	0,60	BPMR7A	4626	02	5959
126 Mot. 25cc	0,70	BPMR7A	4626	02	5959
127 B / L	0,60	BPMR7A	4626	02	5959
128 Mot. 25cc	0,50	BPMR7A	4626	02	5959
129 L	0,60	BPMR7A	4626	02	5959
135 / 136	0,50	BM6A	5921	01	5478
137 Mot. 34cc	0,70	BPMR6A	6726	08	5063
141 Mot. 40cc	0,50	BPMR6A	6726	08	5063
142 SB Mot. 40.7cc	0,60	BPMR7A	4626	02	5959
152 / 153	0,70	BPMR6A	6726	08	5063
154, 154SB Mot. 54.2cc	0,60	BPMR7A	4626	02	5959
664	0,70	BPMR7A	4626	02	5959

Modèle

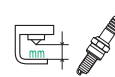
 N° STOCK BOÎTE
 N° BLISTER
 N° STOCK BLISTER

SOLO - Générateurs

101, 118, 119, 124, 126, 127, 128, 130, 132	0,50	BPMR6A	6726	08	5063
127 H / 130 H	0,50	C5HSB	6452	-	-
134, 140, 141	0,50	BPMR6A	6726	08	5063
236	0,60	B-4	3210	-	-
237 / 410 / 412	0,60	B6HS	4510	-	-
414	0,50	BPMR7A	4626	02	5959
422	0,50	BPMR6A	6726	08	5063
423	0,50	B6HS	4510	-	-
603, 633, 634, 636, 639, 641, 644, 639 D, 645 D	0,50	BPMR6A	6726	08	5063
647, 651, 651 SP, 654, 662, 667, 670, 680, 690	0,50	BPMR6A	6726	08	5063
Combimotor 272	0,60	B6HS	4510	-	-

SOLO - Outils Divers

436 / 437 / 439	0,50	B7HS	5110	-	-
440 / 441	0,60	BPMR6A	6726	08	5063
444 / 445 / 450	0,50	BPMR7A	4626	02	5959
459	0,50	B7HS	5110	-	-
471 / 472	0,50	BPMR7A	4626	02	5959
501-2T Mot. Solo	0,60	BPMR6A	6726	08	5063
501-4T Mot. Honda, 502	0,50	CR5HSB	6535	-	-
503	0,50	BR2-LM	5798	06	4740
504 / 508	0,70	BPR6ES	7822	04	7678

SOLO SCREED - Débroussailleuses

Trimmer Mot. Honda 4 hp	0,70	BPR6ES	7822	04	7678
-------------------------	------	--------	------	----	------

SOLO - Tondeuses

102 / 103 / 106 / 107 / 110 / 111 / 114	0,80	BM7A	6521	10	6793
518	0,50	BR2-LM	5798	06	4740
518 - Mot. Honda 4 hp	0,80	BPR5ES	7422	03	6854
520	0,50	B6HS-5	6154	-	-
522	0,80	B5HS	4210	-	-
522 - Mot. B&S	0,50	BMR6A	7421	01	5478
526-50 - Mot. Honda GX160 5.5 hp	0,80	BPR5ES	7422	03	6854
526-60 - Mot. Honda GX200 6.5 hp	0,80	BPR6ES	7822	04	7678
526-75 - Mot. Honda GX270 9 hp	0,80	BPR6ES	7822	04	7678
530 - Mot. B&S 3.5 hp	0,70	BR2-LM	5798	06	4740
531 - Mot. Honda 4.5 hp	0,80	BPR6ES	7822	04	7678
531 (1998-1999)	0,50	BR2-LM	5798	06	4740
531 (1999-2000)	0,70	BP6ES	7811	04	7678
532	0,70	BPR6ES	7822	04	7678
532 / 532-02 - Mot. Honda 5.5 hp	0,80	BPR5ES	7422	03	6854
543	0,50	B5HS	4210	-	-
543L	0,80	B5HS	4210	-	-
545	0,50	B4-LM	3410	05	4358
545 - Mot. B&S 5 hp	0,70	BR2-LM	5798	06	4740
545 R	0,50	BR2-LM	5798	06	4740
545R - Mot. B&S 5 hp, 546 - Mot. B&S 5 hp	0,70	BR2-LM	5798	06	4740
546 Mot. B&S	0,50	BMR6A	7421	01	5478
546HRM	0,80	BPR5ES	7422	03	6854
546RS Mot. B&S 5 hp, 546RT - Mot. B&S 5.5 hp	0,70	BR2-LM	5798	06	4740
548 R	0,70	BPR5ES	7422	03	6854
548R - Mot. B&S 5 hp	0,70	BR2-LM	5798	06	4740
550 - Mot. B&S	0,50	BMR6A	7421	01	5478
550 - Mot. B&S 5.5 hp	0,70	BR2-LM	5798	06	4740
550 H Honda, 550HR - Mot. Honda	0,50	BP5ES	6511	03	6854
550HR - Mot. Honda 5.5 hp	0,80	BP4ES	6928	-	-
550R - Mot. B&S 5.5 hp	0,70	BR2-LM	5798	06	4740
550R Mot. B&S, 550RS - Mot. B&S	0,50	BMR6A	7421	01	5478
550RS - Mot. B&S 5.5 hp	0,70	BR2-LM	5798	06	4740
551R - Mot. B&S 5 hp	0,70	B2-LM	1147	06	4740
551ZR - Mot. B&S	0,50	BMR6A	7421	01	5478
551ZR - Mot. B&S 5 hp	0,80	BPR5ES	7422	03	6854
552 - Mot. B&S	0,80	BCPR5ES	6130	07	4803
552 Z - Mot. F&S, 552 ZR - Mot. F&S	0,50	B5HS	4210	-	-
552HR - Mot. B&S 6 hp	0,80	BP5ES	6511	03	6854
552HR - Mot. Honda	0,50	BP5ES	6511	03	6854
552HR - Mot. Honda 5.5 hp	0,80	BP4ES	6928	-	-
552R - Mot. B&S	0,80	BCPR5ES	6130	07	4803
552Z, 552ZR	0,80	B5HS	4210	-	-
553 S	0,60	BKR5ES	2460	07	4803
553S - Mot. B&S 5.5 hp	0,70	BR2-LM	5798	06	4740
553SL - Honda	0,50	BPR5ES	7422	03	6854
553SL - Mot. B&S 6 hp	0,80	BP5ES	6511	03	6854
554	0,80	B6HS	4510	-	-

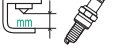
Modèle		N°			
		STOCK BOÎTE	BLISTER	STOCK BLISTER	
554 - Mot. B&S	0,50	BMR6A	7421	01	5478
554L	0,80	B6HS	4510	-	-
554Z - Mot. B&S	0,50	BMR6A	7421	01	5478
554Z - Mot. B&S 5 hp	0,80	BPR5ES	7422	03	6854
555 - Mot. B&S 12,5 hp, 555 (Soupapes latérales)	0,60	BKR5ES	2460	07	4803
555 OHV	0,70	BR2-LM	5798	06	4740
556 - Mot. B&S 6,5 hp, 556 (Soupapes latérales)	0,60	BKR5ES	2460	07	4803
556 OHV	0,70	BR2-LM	5798	06	4740
557 - Mot. B&S 12,5 hp, 557 (Soupapes latérales)	0,60	BKR5ES	2460	07	4803
557 OHV	0,70	BR2-LM	5798	06	4740
558 - Mot. B&S 12,5 hp, 558 (Soupapes latérales)	0,60	BKR5ES	2460	07	4803
558 OHV, 559 - Mot. B&S 5,5 hp	0,70	BR2-LM	5798	06	4740
560 - Mot. B&S 13,5 hp, 560 (Soupapes latérales)	0,60	BKR5ES	2460	07	4803
560 OHV	0,70	BR2-LM	5798	06	4740
562 - Mot. B&S 12,5 hp, 562 (Soupapes latérales)	0,60	BKR5ES	2460	07	4803
562 OHV	0,50	BR2-LM	5798	06	4740
563, 563L	0,50	B6HS-5	6154	-	-
570 - Mot. B&S 13,5 hp, 570 (Soupapes latérales)	0,60	BKR5ES	2460	07	4803
570 OHV	0,70	BR2-LM	5798	06	4740
572 - Mot. B&S 17 hp, 572 (Soupapes latérales)	0,60	BKR5ES	2460	07	4803
575 - Mot. B&S Intek V-Twin 20 hp, 575 OHV	0,60	BKR5ES	2460	07	4803
576 - Mot. B&S Intek V-Twin 22 hp, 576 OHV	0,60	BKR5ES	2460	07	4803
577	0,80	B5HS	4210	-	-
580	0,70	BR6HS	3922	-	-
581, 583	0,80	B5HS	4210	-	-
581 - Mot. B&S	0,70	BR2-LM	5798	06	4740
581 - Mot. Honda	0,80	BPR5ES	7422	03	6854
582T - Mot. B&S 5,5 hp	0,70	BR2-LM	5798	06	4740
Mot. Aspera	0,60	B4-LM	3410	05	4358
Mot. B&S 3,5 / 3,75 / 4,5 / 5,5 / 10,5 / 13 / 15,5 hp	0,70	BR2-LM	5798	06	4740
Mot. B&S 4 / 5 hp	0,80	BPR5ES	7422	03	6854
Mot. B&S Intek 18 / 20 hp	0,90	BKR5E	7938	07	4803
Mot. Honda 4 / 5 hp	0,60	BP5ES	6511	03	6854
Piano 549	0,50	B6HS-5	6154	-	-
Piano 581	0,60	B5HS	4210	-	-
Pro-Mower 549, 580	0,60	B6HS	4510	-	-

SOLO - Tronçonneuses

70	0,60	B5HS	4210	-	-
101	0,50	BPMR6A	6726	08	5063
508, 509, 510, 515, 519, 527, 533, 544, 545, 604	0,60	B5HS	4210	-	-
600 B / Mini	0,50	BPM6A	7021	08	5063
603, 633, 634	0,80	BPMR7A	4626	02	5959
603 Mot. 103cc	0,80	BPMR6A	6726	08	5063
605 (-> 84), 605AV, 606 (-> 84), 606AV, 610AV	0,50	BPM6A	7021	08	5063
610VA	0,50	BPMR7A	4626	02	5959
610VA (-> 84)	0,50	BPM6A	7021	08	5063
611VA	0,50	BPMR7A	4626	02	5959
615AV	0,50	BPM6A	7021	08	5063
615VA	0,50	BPMR7A	4626	02	5959
615VA (-> 80), 616 (-> 80), 616AC, 616AV	0,50	BPM6A	7021	08	5063
616VA	0,50	BPMR7A	4626	02	5959
620 (-> 81), 620AV	0,50	BPM6A	7021	08	5063
620VA	0,50	BPMR7A	4626	02	5959
634 Mot. 34cc	0,80	BPMR6A	6726	08	5063
635-14 Mot. 36,3cc	0,50	BPMR8Y	2218	-	-
635VA	0,50	BPMR7A	4626	02	5959
626	0,60	BR6HS	3922	-	-
636	0,60	BPMR7A	4626	02	5959
636 - Mot. 36,2cc	0,80	BPMR7A	4626	02	5959
636-14 Mot. 36,3cc, 636-16 Mot. 36,3cc	0,50	BPMR8Y	2218	-	-
637	0,80	BPMR7A	4626	02	5959
638 / 641 / 642 / 643, 639 - Mot. 38,2cc	0,80	BPMR7A	4626	02	5959
640C	0,50	BPM6A	7021	08	5063
641 Mot. 41,5cc	0,80	BPMR6A	6726	08	5063
642	0,50	BM7A	6521	10	6793
642 (-> 78)	0,70	BMR6A	7421	01	5478
643IP-16 Mot. 40,2cc	0,50	BPMR8Y	2218	-	-
644, 645	0,50	BPMR7A	4626	02	5959
644 Mot. 44,3cc	0,50	BPMR6A	6726	08	5063
644H, 644SP	0,50	BPMR7A	4626	02	5959
644SP Mot. 44,3cc	0,50	BPMR6A	6726	08	5063
644VA, 645 - Mot. 44cc	0,50	BPMR7A	4626	02	5959
647	0,80	BPMR7A	4626	02	5959
647 Mot. 47cc	0,80	BPMR6A	6726	08	5063
650AV, 650VA (->84)	0,50	BPM6A	7021	08	5063
651 Mot. 51cc, 651SP, 651SP Mot. 51cc	0,50	BPMR7A	4626	02	5959
655AV	0,50	BPM6A	7021	08	5063

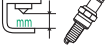
Modèle		N°			
		STOCK BOÎTE	BLISTER	STOCK BLISTER	
656, 662	0,80	BPMR7A	4626	02	5959
656-18 Mot. 56cc	0,50	BPMR8Y	2218	-	-
660AV	0,50	BPM6A	7021	08	5063
662 - Mot. 63cc	0,80	BPMR7A	4626	02	5959
664	0,50	BPM6A	7021	08	5063
665-20 Mot. 65,9cc	0,50	BPMR8Y	2218	-	-
665AV	0,50	BPM6A	7021	08	5063
667, 670, 673	0,50	BPMR7A	4626	02	5959
667, 670 - Mot. 69cc, 667W	0,80	BPMR7A	4626	02	5959
675	0,80	BPMR7A	4626	02	5959
675 Mot. 74,6cc, 5,9 hp	0,60	BPMR8Y	2218	-	-
675-20 Mot. 74,6cc, 5,9 hp	0,50	BPMR8Y	2218	-	-
680 / W, 690 D / WD, 694	0,80	BPMR7A	4626	02	5959
680 Mot. 81cc	0,80	BPMR6A	6726	08	5063
690 - Mot. 90cc	0,80	BPMR7A	4626	02	5959
880, 881 Mot. 81cc	0,50	BPMR7A	4626	02	5959
G31, G32, G38, T30, T40, T45	0,50	BPMR7A	4626	02	5959
Twin 100	0,50	BM7A	6521	10	6793

SPARTAN - Débroussailleuses

PC 27 / 35	0,70	BR6S	3522	09	6048
PCE 24	0,70	BMR6A	7421	01	5478

SPARTAN - Tronçonneuses

34 / AV / AV12, Standart, Deluxe	0,70	BM7A	6521	10	6793
----------------------------------	------	------	------	----	------

SPEED LIFT - Manutention

Tous modèles	0,60	BR6S	3522	09	6048
--------------	------	------	------	----	------

SPEDEX - Tondeuses

Culasse Ø18 mm	0,60	AB-6	2910	-	-
Mot. B&S	0,80	B2-LM	1147	06	4740
Mot. B&S 16 hp	0,70	BR6S	3522	09	6048
Mot. B&S Twin 14 / 16 hp	0,70	BR2-LM	5798	06	4740
Mot. Kohler	0,80	B-6L	3212	-	-
Mot. Kohler Twin 18 hp	0,60	BPR4FS	1127	-	-

SPEEDLOADER - Manutention

C1100	0,80	WR5	2438	-	-
C500, C502, C750, I400-T	0,60	BR6S	3522	09	6048
I600-T, I800-T	0,80	WR5	2438	-	-

SPERRY-NEW HOLLAND - Manutention

Mot. Kohler K582 23 hp	0,60	B-4L	3112	-	-
Mot. Winconsin TJD / VG4D / VH4D	0,70	AB-6	2910	-	-
Mot. Winconsin V465D	0,70	BP5ES	6511	03	6854

SPERRY-NEW HOLLAND - Tondeuses

Mot. B&S	0,60	B2-LM	1147	06	4740
Mot. Kohler	0,60	B-6L	3212	-	-

SPINAWAY - Tondeuses

Tous modèles	0,70	BR2-LM	5798	06	4740
--------------	------	--------	------	----	------

SPIRIT II - Tondeuses

Mot. B&S 12 / 12,5 hp	0,70	BR2-LM	5798	06	4740
Mot. B&S Vang. V-Twin 14 / 16 / 18 / 20hp	0,90	BKR5E	7938	07	4803
Mot. Kohler V-Twin 20 hp	0,90	BKR5E	7938	07	4803

STANDARD - Tondeuses

Culasse Ø14 mm	0,70	BR6S	3522	09	6048
Culasse Ø18 mm	0,80	AB-6	2910	-	-

STAR BLACK & DECKER - Tronçonneuses

Tous modèles	0,60	BMR6F	2144	11	7683
--------------	------	-------	------	----	------

STARK - Tondeuses

Mot. B&S	0,80	BMR6A	7421	01	5478
----------	------	-------	------	----	------

Modèle

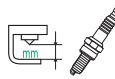
 N° STOCK BLISTER STOCK
BOÎTE BLISTER

STAUB - Débroussailleuses

SD 156 Mot. Subaru EA 190V	0,70	BPR7HS	6422	-	-
SD Pro 80 Mot. Subaru EX 27 OHC	0,70	BR6HS	3922	-	-
SDF 51 Mot. Kawasaki FJ 180V OHV	0,80	BPR5ES	7422	03	6854
SDF 516 Mot. Subaru EA 190V	0,70	BPR7HS	6422	-	-
SDF 60 Mot. Kawasaki FJ 180V OHV	0,80	BPR5ES	7422	03	6854
SDP 156 / 456 Mot. Subaru EA 190V	0,70	BPR7HS	6422	-	-
SDP 565 Mot. Honda GXV 340 OHV	0,80	BPR5ES	7422	03	6854

STAUB - Outils Divers

480 B Mot. B&S 750	0,80	BCP5ES	7496	07	4803
Farmer HX Mot. Honda GX 160 OHV	0,80	BPR5ES	7422	03	6854
Farmer K1 K800H Mot. Emak K800 H	0,80	BKR6E	6962	-	-
FC 30H Mot. ACME LGA 340 Alpin	0,90	BKR5E	7938	07	4803
Maxibèche Mot. Kawasaki FJ 100D OHV	0,70	BR6HS	3922	-	-
Mecabèche Mot. Mitsubishi GT 240	0,70	BPR6HS	7022	-	-
Micro 4 Mot. Subaru EH 035	0,70	BMR6A	7421	01	5478
Microbèche & Microbineuse Mot. Honda GX 25	0,70	CMR5H	7599	-	-
MTF 141H Mot. ACME LGA 340 Alpin	0,90	BKR5E	7938	07	4803
MTF 52 / MTF 72 Mot. Kohler CH270	0,90	BCPR5ES	6130	07	4803
Rancher Junior Mot. Honda GX 200 OHV	0,80	BPR5ES	7422	03	6854
Rancher K1050 Mot. Kohler CH395	0,90	BKR5E	7938	07	4803
Rancher K1050 roues 500X10 Mot. Kohler CH395	0,90	BKR5E	7938	07	4803
Rancher K1065 Mot. Kohler CH395	0,90	BKR5E	7938	07	4803
Rancher K1065 roue 650/80X12 Mot. Kohler CH395	0,90	BKR5E	7938	07	4803
SBR Junior Mot. B&S Serie 550	0,80	BKR6E	6962	-	-
SBR Senior Mot. Subaru EP 17 OHC	0,70	BR4HS	3322	-	-
SC 380 Mot. B&S Serie 550	0,80	BKR6E	6962	-	-
SC 400 Mot. Subaru EP 16 OHC	0,70	BR4HS	3322	-	-
SCP 500 Mot. Honda GX 160 OHV	0,80	BPR5ES	7422	03	6854
SF 80 Mot. Subaru EP 16 OHC	0,70	BR4HS	3322	-	-
ST 2152 RP Mot. B&S Intek OHV 206cc	0,90	BCPR5ES	6130	07	4803
ST 2160 R Mot. B&S 750	0,80	BCP5ES	7496	07	4803
ST 2242A Mot. Mitsubishi GT 400	0,70	BPR6HS	7022	-	-
ST 2442 R Mot. Honda GC 135 OHV	0,90	BPR6E	6464	04	7678
ST 2442 R2D Mot. Honda GX 120 OHV	0,80	BPR5ES	7422	03	6854
ST 2640 RD Mot. Subaru EP 16 OHC	0,70	BR4HS	3322	-	-
ST 2660 RP Mot. Subaru EP 17 OHC	0,70	BR4HS	3322	-	-
ST 2662 RL Mot. Subaru EP 16 OHC	0,70	BR4HS	3322	-	-
ST 2662 RX 2960 Mot. Subaru EP 17 OHC	0,70	BR4HS	3322	-	-
ST 2860 R Mot. Loncin LC170 - 212cc	0,80	BP6ES	7811	04	7678
ST 2960R Mot. Rato 210	0,80	BP6ES	7811	04	7678
ST 4661 F/F2/FL2B Mot. Subaru EP 17 OHC	0,70	BR4HS	3322	-	-
ST 4672 CF/CFLB Mot. Subaru EX 21 OHC	0,70	BR4HS	3322	-	-
ST 5460 RL / 6463 Mot. Honda GX 160 OHV	0,80	BPR5ES	7422	03	6854
STA 54 Mot. Subaru EX 13 OHC	0,70	BR6HS	3922	-	-
STR 55 Mot. Honda GX 160 OHV	0,80	BPR5ES	7422	03	6854
STR 56 Mot. Subaru EP 17 OHC	0,70	BR4HS	3322	-	-
STV 3600 / 3600 P Mot. Subaru EP 17 OHC	0,70	BR4HS	3322	-	-

STAUB - Tondeuses

Blizzard 17,5 H Mot. B&S Intek 4175	0,90	BKR5E	7938	07	4803
Blizzard 18H B&S Vanguard V-Twin 18hp	0,90	BKR5EZ	7642	07	4803
Blizzard 92S 13H B&S Pow. Built 3130 AVS	0,90	BKR5E	7938	07	4803
Rafale 84 12,5KH Emak K1450 AVD 14,5hp	0,90	BKR5E	7938	07	4803
Rafale 98L 14,5KH Emak K1450 AVD 14,5hp	0,90	BKR5E	7938	07	4803
Rider Alizé B&S Pow. Built 3130 AVS	0,90	BKR5E	7938	07	4803
S440 P Essential Mot. B&S Serie 450E	0,70	BR2-LM	5798	06	4740
S440 PK Essential Mot. Emak K600 OHV	0,80	BKR6E	6962	-	-
S440 PK Mot. Emak K500 OHV	0,80	BKR6E	6962	-	-
S440TK Essential Mot. Emak K500 OHV	0,80	BKR6E	6962	-	-
S500 TB(P) Essential Mot. B&S Serie 450E	0,70	BR2-LM	5798	06	4740
S500 TBQ Confort Mot. B&S Serie 550	0,80	BKR6E	6962	-	-
S500 TBXE Confort Mot. B&S 675	0,70	BR2-LM	5798	06	4740
S500 TH Confort Mot. Honda GCV135	0,90	BPR6ES	7822	04	7678
S500 TK Allroad K650 Mot. Emak K650 OHV	0,80	BKR6E	6962	-	-
S500 TK Essential Mot. Emak K600 OHV	0,80	BKR6E	6962	-	-
S530 TBXE Allroad / Confort Plus Mot. B&S 675	0,70	BR2-LM	5798	06	4740
S530 TH "190KM" Confort Honda GCV190	0,80	BKR6E	6962	-	-
S530 THX / THX Allroad Mot. Honda GCV160 OHC	0,80	BKR6E	6962	-	-
S530 TK Allroad Mot. Emak K800 OHV	0,80	BKR6E	6962	-	-
S530 TK Confort K650 Mot. Emak K650 OHV	0,80	BKR6E	6962	-	-
S4501TH Mot. Honda GCV135	0,90	BPR6ES	7822	04	7678
S5000 TK Mot. Emak K600 OHV	0,80	BKR6E	6962	-	-

Modèle

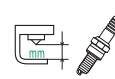
 N° STOCK BLISTER STOCK
BOÎTE BLISTER

S5000 TK Alu. Allroad Mot. Emak K650 OHV	0,80	BKR6E	6962	-	-
S5300 TK Alu. Allroad Mot. Emak K800 OHV	0,80	BKR6E	6962	-	-
S5300TBS Mot. B&S 675	0,70	BR2-LM	5798	06	4740
S5300TK Mot. Emak K800 OHV	0,80	BKR6E	6962	-	-
S5500 HXF Alu. Mot. Honda GX160 OHV	0,80	BPR5ES	7422	03	6854
S5500HXF Mot. Honda GX160 OHV	0,80	BPR5ES	7422	03	6854
Sael 97/13T Mot. B&S I/CAVS OHV 13,5 hp	0,90	BCPR5ES	6130	07	4803
Satr 17,5 H Mot. B&S INTEK OHV 17,5 hp	0,90	BCPR5ES	6130	07	4803
SC500 TK Allroad Plus4 Emak K600 OHV	0,80	BKR6E	6962	-	-
SC530 TK Allroad Plus4 Emak K800 OHV	0,80	BKR6E	6962	-	-
SP500 TBX Allroad EXA4 Mot. B&S 625	0,70	BR2-LM	5798	06	4740
SP500 TK Allroad EXA4 Emak K650 OHV	0,80	BKR6E	6962	-	-
SP530 THX Allroad EXA4 Honda GCV160 OHC	0,80	BKR6E	6962	-	-
SP530 TK Allroad EXA4 Emak K800 OHV	0,80	BKR6E	6962	-	-
Tourno Compact 115 Honda GX620 20hp	0,80	BPR5ES	7422	03	6854
Tourno Delux. 115 4WD Honda GX620 20hp	0,80	BPR5ES	7422	03	6854

STEARNS - Tondeuses

200Series - Mot. B&S Intek OHV 18 / 26 hp	0,60	BKR5ES	2460	07	4803
200Series - Mot. B&S OHV 17,5 hp	0,60	BKR5ES	2460	07	4803
200Series - Mot. Kawasaki OHV 19 / 25 hp	0,90	BCPR6ES	2330	-	-
200Series - Mot. Kohler Command 27 hp	0,60	BKR5ES	2460	07	4803
230 - Mot. Kohler 27 hp	0,60	BKR5ES	2460	07	4803
230 / 430Max- Mot. Kubota WG752 25 hp	1,10	BCPR4ES-11	2378	-	-
415 - Mot. Kohler 23 hp	0,60	BKR5ES	2460	07	4803
430Max - Mot. Kohler Command 27 hp	0,60	BKR5ES	2460	07	4803
440-34KO - Mot. Kohler (Ref. Air) 34 hp	0,70	BKR5ES	2460	07	4803
440-40KO - Mot. Kohler (Ref. Air) 40 hp	0,70	BKR5ES	2460	07	4803
Culasse Ø14 mm	0,70	BR2-LM	5798	06	4740
Culasse Ø18 mm	0,80	AB-6	2910	-	-
LX1200G - Mot. Robin EH34V 11 hp	0,80	BPR6ES	7822	04	7678
ST350 - Mot. Robin EH34V 11 hp	0,80	BPR6ES	7822	04	7678
ST480 - Mot. B&S Vanguard 16 hp	0,60	BKR5ES	2460	07	4803

STERNS - Tondeuses

Culasse Ø14 mm	0,60	B4-LM	3410	05	4358
Culasse Ø18 mm	0,60	AB-6	2910	-	-

STIGA - Outils Divers

Silex 95 H Mot. Honda GCV160	0,70	BPR5ES	7422	03	6854
------------------------------	------	--------	------	----	------

STIGA - Tondeuses

Compact - Mot. B&S I/C OHV 15.5 hp	0,60	BKR5ES	2460	07	4803
Estate Grd. Overland Pro 4WD E Mot. GXV660	0,70	ZFR5F	5165	-	-
Estate Royal H Mot. Honda GCV530	0,70	BPR5ES	7422	03	6854
Estate Senator H HST Mot. Honda GCV530	0,70	BPR5ES	7422	03	6854
Excel 50 SQ H Mot. Honda GCV160	0,70	BPR5ES	7422	03	6854
Excel 55 SQ H BBC Mot. Honda GCV190	0,70	BPR5ES	7422	03	6854
Garden Combi H HST Mot. Honda GXV390	0,70	BPR5ES	7422	03	6854
Mot. B&S 2 / 3.5 / 4 / 5 / 8.5 / 10.5 / 11.5 / 12.5 hp	0,70	BR2-LM	5798	06	4740
Mot. B&S Intek OHV 6 hp	0,60	BCPR5ES	6130	07	4803
Mot. B&S Vanguard V-Twin 16 / 18 hp	0,80	BCPR5ES	6130	07	4803
Multiclip Pro 50 S Svan Mot. Honda GCV160	0,70	BPR5ES	7422	03	6854
Multiclip Pro 50 S4 Inox Svan Honda GCV160	0,70	BPR5ES	7422	03	6854
Multiclip Pro 50 Svan Mot. Honda GCV160	0,70	BPR5ES	7422	03	6854
Multiclip Pro 53 S Svan Mot. Honda GCV160	0,70	BPR5ES	7422	03	6854
Multiclip Pro 53 S4 Svan Mot. Honda GCV190	0,70	BPR5ES	7422	03	6854
Park Pro 25 4WD Mot. Honda GXV660	0,70	ZFR5F	5165	-	-
Park Pro Svan 4WD Mot. Honda GXV530	0,70	BPR5ES	7422	03	6854
Park Ranger Svan Mot. Honda GCV530	0,70	BPR5ES	7422	03	6854
Park Royal 4WD Mot. Honda GCV530	0,70	BPR5ES	7422	03	6854
Prestige - Mot. Kohler Courage 18 hp	0,60	BKR5ES	2460	07	4803
Privat 8E	0,50	BM6A	5921	01	5478
Pro 16 - Mot. B&S Vanguard 16 hp	0,60	BKR5ES	2460	07	4803
Pro 20 - Mot. B&S Vanguard 20 hp	0,60	BKR5ES	2460	07	4803
Pro 25 - Mot. Kohler Courage 25 hp	0,60	BKR5ES	2460	07	4803
Turbo 48 S H Mot. Honda GCV160	0,70	BPR5ES	7422	03	6854
Turbo 50 S H Mot. Honda GCV160	0,70	BPR5ES	7422	03	6854
Turbo 53 S H Mot. Honda GCV190	0,70	BPR5ES	7422	03	6854
Turbo Pro 55 S4 Mot. Honda GCV190	0,70	BPR5ES	7422	03	6854
Villa Silent Mot. Honda GXV390	0,70	BPR5ES	7422	03	6854

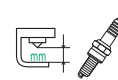
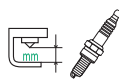

STIHL - Débroussailleuses

BR 106	0,50	BPMR6A	6726	08	5063
BR 320 / 320L / 400	0,70	BPMR7A	4626	02	5959
FC 100 / 110	0,60	CMR6H	3365	12	4794
FC 44	0,70	BMR6A	7421	01	5478
FC 55	0,70	BPMR7A	4626	02	5959
FC 56	0,60	CMR6H	3365	12	4794
FC 73	0,70	CMR7A	7543	-	-
FC 75	0,70	BPMR7A	4626	02	5959
FC 83	0,70	CMR7A	7543	-	-
FC 85	0,70	BPMR7A	4626	02	5959
FC 90 / 95	0,60	CMR6H	3365	12	4794
FH 75	0,50	BPMR7A	4626	02	5959
FR 108 / FR 350	0,70	BPMR7A	4626	02	5959
FR 38	0,70	BMR6A	7421	01	5478
FR 85 / FR 450 / 480, FS 20	0,70	BPMR7A	4626	02	5959
FS 36 / 38 / 40 / 44 / 44J / 44R	0,60	BMR6A	7421	01	5478
FS 45 / 45C, FS 46 / 46C, FS 48	0,70	BPMR7A	4626	02	5959
FS 50 / 51	0,60	BMR6A	7421	01	5478
FS 52, F55 / 55 C / 55R / 55RC	0,70	BPMR7A	4626	02	5959
FS 56 AVRE, FS 60 / 61	0,60	BMR6A	7421	01	5478
FS 62	0,70	BPMR7A	4626	02	5959
FS 65	0,60	BMR6A	7421	01	5478
FS 65-4 / 65-4R	0,50	CMR6H	3365	12	4794
FS 66	0,50	BMR6A	7421	01	5478
FS 72	0,70	BPMR6A	6726	08	5063
FS 74	0,70	BPMR7A	4626	02	5959
FS 74 AVE, FS 74 AVRE	0,70	BPMR6A	6726	08	5063
FS 75	0,70	BPMR7A	4626	02	5959
FS 76 AVE, FS 76 AVRE	0,70	BPMR6A	6726	08	5063
FS 80R / 81 / 85, FS 85 R	0,70	BPMR7A	4626	02	5959
FS 85 RT	0,50	BPMR7A	4626	02	5959
FS 85 T	0,70	BPMR7A	4626	02	5959
FS 86 -> No.14821680	0,60	BMR6A	7421	01	5478
FS 86 AVRE	0,70	BPMR6A	6726	08	5063
FS 86 No.15821680->	0,70	BPMR7A	4626	02	5959
FS 90 Viernix	0,60	CMR6H	3365	12	4794
FS 96	0,50	BMR6A	7421	01	5478
FS 100 RX Viernix	0,50	CMR6H	3365	12	4794
FS 100 Viernix	0,60	CMR6H	3365	12	4794
FS 106	0,70	BPMR7A	4626	02	5959
FS 106 AVE / 108	0,70	BPMR6A	6726	08	5063
FS 110	0,80	CMR5H	7599	-	-
FS 110 - 4Mix 1.3hp	0,70	CMR7H	3066	-	-
FS 110 R	0,80	CMR5H	7599	-	-
FS 110 Viernix	0,50	CMR6H	3365	12	4794
FS 120 / 120 R	0,70	BPMR7A	4626	02	5959
FS 130	0,70	CMR6H	3365	12	4794
FS 130 4-Mix	0,50	CMR6H	3365	12	4794
FS 130 R	0,80	CMR5H	7599	-	-
FS 130 Viernix	0,50	CMR6H	3365	12	4794
FS 150 / 151 / 160 / 180 / 200 / 200AV / 200AVE	0,70	BPMR7A	4626	02	5959
FS 200R / 202 / 202AV / 220 / 250 / 250R	0,70	BPMR7A	4626	02	5959
FS 25-4 / 25-4R	0,50	CMR6H	3365	12	4794
FS 280 / 280 K, FS 300	0,70	BPMR7A	4626	02	5959
FS 310	0,50	CMR6H	3365	12	4794
FS 350 / 360 AVEZ	0,70	BPMR7A	4626	02	5959
FS 400	0,50	BPMR7A	4626	02	5959
FS 400 K, FS 401	0,70	BPMR7A	4626	02	5959
FS 401 AVE	0,70	BPMR6A	6726	08	5063
FS 410 / 410 AVE / 420 / 450 / 450 K / 480 / 480K	0,70	BPMR7A	4626	02	5959
FS 500 / 550, H 151, HL 45	0,70	BPMR7A	4626	02	5959
HL 73	0,70	CMR7A	7543	-	-
HL 75 L	0,50	BPMR6A	6726	08	5063
HL 90 / 100	0,80	CMR5H	7599	-	-
HS 45 / 60 / 61	0,70	BPMR7A	4626	02	5959
HS 72 / 74	0,50	BPMR6A	6726	08	5063
HS 75	0,70	BPMR7A	4626	02	5959
HS 76	0,50	BPMR6A	6726	08	5063
HS 80	0,70	BPMR7A	4626	02	5959
HS 81 R / 86	0,80	CMR5H	7599	-	-
HS 151 / 202 / 242	0,70	BPMR7A	4626	02	5959
HT 70 / 70 Z, HT 73 / 75 / 75 Z	0,70	CMR7A	7543	-	-
HT 101 / 130 / 131	0,50	CMR6H	3365	12	4794
HTR 85	0,50	BPMR6A	6726	08	5063
KM 100 FS / RFS / RHL / RHT	0,60	CMR6H	3365	12	4794

KM 55 CFS / FS / RCFS / RFS	0,70	BPMR7A	4626	02	5959
KM 55 RCHL / RCHT / RFS / RHL / RHT	0,70	BPMR7A	4626	02	5959
KM 85, KM 85 RFS / RHL / RHT	0,70	BPMR7A	4626	02	5959
KW 85	0,50	BPMR7A	4626	02	5959
SR 320 / 400	0,70	BPMR7A	4626	02	5959

STIHL - Générateurs

1401	0,50	AB-6	2910	-	-
1106 (6.5PS)	0,50	BPM6A	7021	08	5063
1106 (8.5PS)	0,50	BPM7A	7321	02	5959
1108, 1109 (6.5PS), 1110, 1111, 1112, 1113	0,50	BPM6A	7021	08	5063
4202	0,50	BPM6A	7021	08	5063
BG 56, BG 56 C	0,50	CMR6H	3365	12	4794
BG 60	0,60	BMR6A	7421	01	5478
BG 66, BG 66 C	0,50	CMR6H	3365	12	4794
BG 72, BG 75	0,50	BPMR7A	4626	02	5959
BG 86, BG 86 C	0,50	CMR6H	3365	12	4794
BR 106, BR 320, BR 400	0,50	BPMR7A	4626	02	5959
BR 500, BR 550, BR 600	0,50	CMR6H	3365	12	4794
BT 106 C, BT 360	0,50	BPMR7A	4626	02	5959
FS 50 E, FS 51 AVE	0,60	BMR6A	7421	01	5478
FS 52	0,60	BPMR7A	4626	02	5959
FS 61 E, FS 61 RE	0,60	BMR6A	7421	01	5478
FS 62, FS 62 R	0,60	BPMR7A	4626	02	5959
FS 65 AVE, FS 65 AVRE	0,60	BMR6A	7421	01	5478
FS 66 R, FS 67, FS 67 R	0,60	BPMR7A	4626	02	5959
FS 80 AVE, FS 80 AVRE, FS 80 E, FS 80 RE	0,60	BMR6A	7421	01	5478
FS 86, FS 86 R, FS 90	0,60	BPMR7A	4626	02	5959
FS 90 AVE	0,60	BMR6A	7421	01	5478
FS 96R	0,60	BPMR7A	4626	02	5959
FS 106, FS 106 R	0,60	BPMR7A	4626	02	5959
HS60	0,60	BMR6A	7421	01	5478
KM 90, KM 90 R, KM 130, KM 130 R	0,60	CMR6H	3365	12	4794
SH 56, SH 56 C, SH 86, SH 86 C	0,50	CMR6H	3365	12	4794
SR 320 / 420, TS 360 S / 400 / 460 / 510 / 760	0,50	BPMR7A	4626	02	5959

STIHL - Outils Divers

MM 55	0,50	BPMR7A	4626	02	5959
-------	------	--------	------	----	------

STIHL - Tondeuses

FS 74 / 106 / 160 / 220 / 280 / 420	0,50	BPMR7A	4626	02	5959
FS86 (->No.14821680)	0,60	BMR6A	7421	01	5478
FS86 (No.15821680->)	0,50	BPMR7A	4626	02	5959

STIHL - Tronçonneuses

06, 07 / S, 08 / S / H	0,50	BPR6HS	7022	-	-
009 / Mini Boss / AV / EQZ / L	0,50	BPMR7A	4626	02	5959
08S	0,50	BR6HS	3922	-	-
010 AV, 011 AV / AVTEQ / T	0,50	BPMR7A	4626	02	5959
015 / AV / AVP / AVS / L / LE / R	0,50	BPMR7A	4626	02	5959
017, 018 / C, 019 T	0,50	BPMR7A	4626	02	5959
020 AV / AVH / AVP / AVS / AVT / T	0,50	BPMR7A	4626	02	5959
021 / Wood Boos, 023 Wood Boos / AV / C / L	0,50	BPMR7A	4626	02	5959
024 / AV / WB, 025 / AVH / Wood Boos / C	0,50	BPMR7A	4626	02	5959
026 / C / S / AVP / PRO / Arctic	0,50	BPMR7A	4626	02	5959
028 / AV / AVE / AVS / WB / S	0,50	BPMR7A	4626	02	5959
029 / Farm Boss, 030, 031 / AV / AVE / AVEQ	0,50	BPMR7A	4626	02	5959
032 / AV / AVE, 034 / AV / AVEQ / WB	0,50	BPMR7A	4626	02	5959
036 / QS / AV / AVS / Pro Arctic / Pro	0,50	BPMR7A	4626	02	5959
038 / AV / AVE / AVS / AVMEQ / Magnum, 039	0,50	BPMR7A	4626	02	5959
040 / G Light Service, 040 / G Normal Service	0,80	BPMR7A	4626	02	5959
040 / G Severe Service	0,80	BMR7A	4226	10	6793
041 / FB / AV / AVE / AVE Super, 042 / AVEQ	0,50	BPMR7A	4626	02	5959
044 / Arctic / AV / AVE / C, 045 / AVE Super	0,50	BPMR7A	4626	02	5959
046 / AVE / Super / Arctic / Magnum / C / RHD	0,50	BPMR7A	4626	02	5959
048 / AV / AVE, 050, 051 AV / AVE	0,50	BPMR7A	4626	02	5959
056 / AV / AVE / AVS	0,50	BPMR7A	4626	02	5959
064 / AVEP / AVEQ / AVREQ	0,50	BPMR7A	4626	02	5959
065, 066 / Magnum / W, 071	0,50	BPMR7A	4626	02	5959
075, 076 / AV, 078AVE	0,50	BPMR7A	4626	02	5959
084 / Z / AVEQ, 088	0,80	BPMR7A	4626	02	5959
090 E / G / R, 1108-CONTRA (G, GS), BG 17	0,50	BPMR6A	6726	08	5063
BG 60E	0,50	BMR6A	7421	01	5478
FR 350 / 450	0,50	BPMR7A	4626	02	5959

Modèle

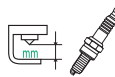
 N° STOCK BOÎTE
 N° BLISTER
 N° STOCK BLISTER

STIHL - Tronçonneuses				
FS 20 / 50 / 61 / 65 / 80 / 90	0,60	BMR6A	7421	01 5478
FS 48 / 52 / 62 / 75 / 81 / 85 / 120	0,50	BPMR7A	4626	02 5959
FS 150 / 200 / 410	0,50	BPMR6A	6726	08 5063
FS 300 / 350	0,50	BPMR7A	4626	02 5959
FS 353	0,50	BPR6HS	7022	- -
FS 400 / 400K / 450 / 550	0,50	BPMR7A	4626	02 5959
Gros bois	0,80	BM6A	5921	01 5478
HS 60	0,60	BMR6A	7421	01 5478
HS 61 / 72 / 74 / 76	0,50	BPMR7A	4626	02 5959
HS 81 R / T, HS 86 R / T, HS 87 R / T	0,50	CMR6H	3365	12 4794
HS 151 / 202 / 242 / 246	0,50	BPMR7A	4626	02 5959
HT 100 / 110 4-MIX	0,60	CMR7H	3066	- -
KS 43	0,50	AB-6	2910	- -
Lighthing Super	0,50	BM7A	6521	10 6793
MS 150TC	0,60	CMR6H	3365	12 4794
MS 170	0,50	BPMR7A	4626	02 5959
MS 171	0,60	CMR6H	3365	12 4794
MS 180 / C / BE	0,50	BPMR7A	4626	02 5959
MS 181, MS 181C	0,60	CMR6H	3365	12 4794
MS 190T / 191T / 192T	0,50	BPMR7A	4626	02 5959
MS 200 / T, 210 / C, 230 / C, 240	0,50	BPMR7A	4626	02 5959
MS 201 / C / T, MS 211 / C	0,60	CMR6H	3365	12 4794
MS 250 / C, 260, 270 / C, 280 / C	0,50	BPMR7A	4626	02 5959
MS 251 / C	0,60	CMR6H	3365	12 4794
MS 261 / C, 271 C, 290, 291 / C, 310, 311, 341	0,50	BPMR7A	4626	02 5959
MS 360 / C, 361 / CQ / W, 362, 390, 391, 440	0,50	BPMR7A	4626	02 5959
MS 441 / C, 460 / Magnum Rescue	0,50	BPMR7A	4626	02 5959
MS 461 / R / R Rescue, 650, 660, 880	0,50	BPMR7A	4626	02 5959
SG17	0,50	BPMR6A	6726	08 5063
TS08 (>18 735 398)	0,80	BPR6HS	7022	- -
TS08 (18 735 399->)	0,80	BPMR7A	4626	02 5959
TS50 / 200 / 360 / 400 / 410 / 420 / 460	0,50	BPMR7A	4626	02 5959
TS350 (>17 451 127)	0,80	BPR6HS	7022	- -
TS350 (17 451 128->), TS350S	0,80	BPMR7A	4626	02 5959
TS480, 510 / AVE, 700, 760AVE, 800	0,50	BPMR7A	4626	02 5959
TS760	0,50	BPMR6A	6726	08 5063

STIHL-STIGA - Tondeuses

BA20 / RA Dino 2T / SB50	0,50	B6S	3510	09 6048
BB800 / President / Privat 8E	0,50	BM6A	5921	01 5478
CB700 / Pony 6 / 8 / Park 20008	0,50	BM6A	5921	01 5478
SB50 vario-speed / Tornado TB300 / TB500	0,50	BM6A	5921	01 5478

STRUNK - Tronçonneuses

Autres modèles	0,80	BR6S	3522	09 6048
Big Timber	1,00	B-4	3210	- -
EBC-1 / EBC-3	0,60	B6S	3510	09 6048
Tall Timber	0,60	BMR6A	7421	01 5478

SUBARU - Voir FUJI-ROBIN - Générateurs

SUBARU-ROBIN - Voir FUJI-ROBIN - Débroussailleuses

SUFFOLK - Tondeuses

12" Colt / Super Colt	0,70	BR6S	3522	09 6048
14" Super Punch, Series 1/1A/2/3/4/5/6/7	0,70	BR6S	3522	09 6048
16" Suffolk, 16"/19" Demon de Luxe	0,70	BR6S	3522	09 6048
17" Super Punch, Series 1/1A/2/3/4/5/6/7	0,70	BR6S	3522	09 6048
19" Side Wheel Mower MK 1/2 / Squire Serie 1/2/3	0,70	BR6S	3522	09 6048
Tous modèles Mot. B&S	0,70	BR2-LM	5798	06 4740

SUNBEAM - Tondeuses

Culasse Ø18 mm	0,80	AB-6	2910	- -
Mot. 2 tps - LMC-2	0,80	BP-4	2911	- -
Mot. 4 tps - LMB-4	0,80	B6S	3510	09 6048
Mot. B&S - Culasse Ø14 mm	0,70	BR2-LM	5798	06 4740
Mot. Tecumseh - Culasse Ø14 mm	0,70	BR6S	3522	09 6048
Mot. Victa - Culasse Ø14 mm	0,70	BM6A	5921	01 5478

Modèle

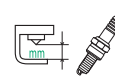
 N° STOCK BOÎTE
 N° BLISTER
 N° STOCK BLISTER

SUTECH STEALTH - Tondeuses				
Mot. B&S 4 / 8 / 10.5 hp	0,60	BR2-LM	5798	06 4740
Mot. B&S Intek OHV 6.5 hp	0,70	BKR5E	7938	07 4803
Mot. B&S Vanguard 12.5 hp	0,60	BKR5E	7938	07 4803
Mot. Honda 2.5 hp	0,80	BM4A	5628	- -
Mot. Kawasaki 9 hp / OHV	0,80	BPR5ES	7422	03 6854

SUZUKI - Générateurs

M 120X	0,70	BPMR4A	6028	- -
S 200K	0,60	BR5HS	3722	- -
S 200KR	0,70	B5HS	4210	- -
S 200R	0,70	BP6HS	4511	- -
S 250	0,70	BP5HS	4111	- -
SD 650R	0,70	BPMR6A	6726	08 5063
SD 1400, SD 2000R	0,80	BPR6ES	7822	04 7678
SE 300	0,40	CM-6	5812	- -
SE 400 / A / C / T, SE 500 / A / C	0,70	BPMR4A	6028	- -
SE 600	0,60	BPMR4A	6028	- -
SE 600 A	0,60	BPM4A	5928	- -
SE 700 / A	0,70	BPMR6A	6726	08 5063
SE 800 / A	0,60	BPMR4A	6028	- -
SE 2000 (2000->)	0,80	BPR6HS	7022	- -
SE 2500 L 1998	0,80	BPR5HS	6222	- -
SE 3000 / A	0,80	BPR6HS	7022	- -
SE 3000 C / L 1998 / AD	0,80	BPR5HS	6222	- -
SE 3800S, SE 4000 S / SE, SE 4000 SED	0,70	BP5HS	4111	- -
SR 1500 / 2000	0,80	BPR6ES	7822	04 7678
SV 1000, SV 1200 / L, SV 1400 L / P, SV 1500	0,80	BPR6ES	7822	04 7678
SV 1800 / L / P, SV 2000 / C / L / P / S / R	0,80	BPR6ES	7822	04 7678
SV 2000 / C / L / P / S / R	0,80	BPR6ES	7822	04 7678
SV 2000 K	0,80	BPR5ES	7422	03 6854
SV 2200 / 2 / L / P, SV 2300 / C / H / L / R	0,80	BPR6ES	7822	04 7678
SV 2500 / L / P, SV 2800	0,80	BPR6ES	7822	04 7678
SV 3800 S, SV 4000 / D / E / P / S	0,80	BPR5ES	7422	03 6854
SV 7500	0,80	BPR6ES	7822	04 7678
SWW 140 / L	0,80	BPR5ES	7422	03 6854
SW 140 S / SE	0,70	BP5HS	4111	- -
SX 600 / R	0,70	BPR4HS	7823	- -
SX 600 R (1998->)	0,70	BPR5HS	6222	- -
SX 650 R / 750 / 800 / 800 R / 900 / 1000	0,80	BPR5HS	6222	- -
V 120 / 160 / 140 X / 420	0,80	BPR6ES	7822	04 7678

SWISHER - Débroussailleuses

ST67522BS, DST67522BS Mot. B&S 675E	0,80	BKR5ES	2460	07 4803
-------------------------------------	------	--------	------	---------

SWISHER - Tondeuses

FC11544BS Mot. B&S 344cc 11.5 hp	0,70	BKR5ES	2460	07 4803
FC12544BS Mot. B&S 344cc 12.5 hp	0,70	BKR5ES	2460	07 4803
FC14560BS Mot. B&S 500cc 14.5 hp	0,70	BKR5ES	2460	07 4803
FC18560BS Mot. B&S 540cc 18.5 hp	0,70	BKR5ES	2460	07 4803
ZT2760B Mot. B&S 724cc 27 hp	0,70	BKR5ES	2460	07 4803
ZTR2454BS Mot. B&S 724cc 24 hp	0,70	BKR5ES	2460	07 4803
ZTR2454KA Mot. Kawasaki FR730V 24 hp	0,80	BPR4ES	7222	- -
ZTR2460BS Mot. B&S 724cc 24 hp	0,70	BKR5ES	2460	07 4803
ZTR2460KA Mot. Kawasaki FR730V 24 hp	0,80	BPR4ES	7222	- -
ZTR2760BS Mot. B&S 724cc 27 hp	0,70	BKR5ES	2460	07 4803
ZTR2866BS Mot. B&S 810cc 28 hp	0,70	BKR5ES	2460	07 4803

SWISH-ERR - Tondeuses

Autres modèles	0,80	B4-LM	3410	05 4358
Mot. B&S	0,70	B2-LM	1147	06 4740
Mot. Robin 4 tps OHV 4 hp	0,80	BR7ES	5122	- -
Mot. Tecumseh 4 hp	0,70	B2-LM	1147	06 4740

TANAKA - Débroussailleuses

160 / 162 / 202 / 205 / 215 / 220 / 232	0,50	BMR6A	7421	01 5478
240 / 250	0,70	BPMR6A	6726	08 5063
262 / 265 / 300 / 322 / 373	0,50	BMR6A	7421	01 5478
420 PF	0,70	BPMR6A	6726	08 5063
422 C / 425	0,50	BMR6A	7421	01 5478
430 PF	0,70	BPMR6A	6726	08 5063
500 / 501	0,50	BMR6A	7421	01 5478

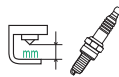

Modèle		N° STOCK BOÎTE	N° BLISTER	N° BLISTER
2110 / 2211 / 2251 / 2410 / 4500 / 5000 / 7000S	0,70	BPMR6A	6726	08 5063
AST 210 Mot. 20cc	0,60	BPM6A	7021	08 5063
AST 250	0,80	BPM6A	7021	08 5063
AST 5000	0,70	BPM6A	7021	08 5063
AST 5770	0,70	BPMR6A	6726	08 5063
AST 7000 Mot. 20cc, AST 7000 S	0,80	BPM6A	7021	08 5063
HTD 2520 PF / 2522 PF / 2526 PF	0,80	BPM6A	7021	08 5063
HTD 2530 PF / 2530 PF	0,80	BPM6A	7021	08 5063
PHT 15 / 25, QUM-2 / 2N, Scythe JHU37	0,80	BM6A	5921	01 5478
SF-PH 230S (B0010001 ->)	0,70	BPMR6A	6726	08 5063
SP 37 / 351 / 411	0,70	BPMR6A	6726	08 5063
SP 502, ST 1600	0,80	BM6A	5921	01 5478
SUM 3 / 301	0,60	BM6A	5921	01 5478
SUM 312 / 318 / 328	0,50	BMR6A	7421	01 5478
SUM 351	0,70	BM7A	6521	10 6793
SUM 421	0,50	BMR6A	7421	01 5478
SW 16 / 20	0,80	BM6A	5921	01 5478
TBC 16 / 23	0,50	BMR6A	7421	01 5478
TBC 30	0,70	BPMR6A	6726	08 5063
TBC 37	0,50	BMR6A	7421	01 5478
TBC 160 (F008200->), TBC 162 (C072005->)	0,80	BM6A	5921	01 5478
TBC 202 (F005800->), TBC 205	0,80	BM6A	5921	01 5478
TBC 215 (F014100->), TBC 218, TBC 220	0,80	BM6A	5921	01 5478
TBC 220 Mot. 21cc	0,60	BPM6A	7021	08 5063
TBC 220 SS	0,70	BPMR6A	6726	08 5063
TBC 225	0,80	BMR6A	7421	01 5478
TBC 225 C	0,70	BMR6A	7421	01 5478
TBC 225 CS / S, TBC 230 / B / SF	0,70	BPMR6A	6726	08 5063
TBC 235	0,50	BMR6A	7421	01 5478
TBC 240	0,80	BM6A	5921	01 5478
TBC 240 PFCS / PFDS / PFS	0,70	BMR7A	4226	10 6793
TBC 240 S	0,70	BM7A	6521	10 6793
TBC 240 SFS	0,70	BMR7A	4226	10 6793
TBC 245	0,80	BMR6A	7421	01 5478
TBC 245 PF	0,60	BPMR7A	4626	02 5959
TBC 250 D	0,80	BMR6A	7421	01 5478
TBC 250 Mot. 24cc, TBC 250 DH	0,60	BPM6A	7021	08 5063
TBC 250 PFD	0,60	BPMR7A	4626	02 5959
TBC 250 SF	0,60	BMR6A	7421	01 5478
TBC 255 SFK	0,70	BM7A	6521	10 6793
TBC 260	0,80	BMR6A	7421	01 5478
TBC 260 PFL / SF	0,70	BM7A	6521	10 6793
TBC 262 (G231370->)	0,80	BM6A	5921	01 5478
TBC 265 / SS (->N006100)	0,70	BM7A	6521	10 6793
TBC 265 / SS (N006101->)	0,80	BM6A	5921	01 5478
TBC 270 PF Mot. 26cc	0,60	BPM7A	7321	02 5959
TBC 270 PFD / PN / PND	0,70	BPMR7A	4626	02 5959
TBC 280	0,70	BPMR6A	6726	08 5063
TBC 280 PF	0,80	BM6A	5921	01 5478
TBC 290	0,80	BMR6A	7421	01 5478
TBC 300 Mot. 29cc	0,70	BM7A	6521	10 6793
TBC 300 SDH / 322 / 325	0,60	BM7A	6521	10 6793
TBC 340 / DS / PFD / S	0,60	BPMR7A	4626	02 5959
TBC 355 / B / DH	0,70	BM7A	6521	10 6793
TBC 373	0,80	BM6A	5921	01 5478
TBC 400 F / PF	0,70	BPMR6A	6726	08 5063
TBC 420	0,70	BPMR6Y	5256	- -
TBC 420 PF Mot. 40cc	0,80	BPM6A	7021	08 5063
TBC 422	0,80	BM6A	5921	01 5478
TBC 422 C Mot. 40cc	0,60	BM6A	5921	01 5478
TBC 425	0,80	BM6A	5921	01 5478
TBC 430 PF Mot. 40cc	0,80	BPM6A	7021	08 5063
TBC 500 Mot. 46cc	0,60	BPM6A	7021	08 5063
TBC 501	0,80	BM6A	5921	01 5478
TBC 550 / 600	0,70	BPMR6A	6726	08 5063
TBC 720 PF	0,80	BPMR6Y	5256	- -
TBC 2000	0,80	BPM6A	7021	08 5063
TBC 2100 / 2110 Mot. 21cc	0,70	BPM6F	5950	- -
TBC 2200, TBC 2211 Mot. 21cc	0,80	BPM6A	7021	08 5063
TBC 2251	0,60	BPMR6A	6726	08 5063
TBC 2410 Mot. 25cc	0,70	BPM6F	5950	- -
TBC 2500	0,80	BMR6A	7421	01 5478
TBC 2501 D / DS	0,60	BMR6A	7421	01 5478
TBC 2501 H (C263177 -> C263752)	0,80	BM6A	5921	01 5478
TBC 2501 S	0,60	BMR6A	7421	01 5478
TBC 2510 Mot. 24cc	0,80	BPM6A	7021	08 5063
TBC 2800	0,70	BMR6F	2144	11 7683

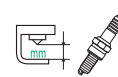

Modèle		N° STOCK BOÎTE	N° BLISTER	N° BLISTER
TBC 2800 Mot. 28cc	0,70	BPM6F	5950	- -
TBC 3010 Mot. 29cc	0,70	BM7A	6521	10 6793
TBC 4000 Mot. 20cc	0,60	BPM6A	7021	08 5063
TBC 4010 Mot. 40cc, TBC 4110 Mot. 40cc	0,80	BM6A	5921	01 5478
TBC 4200	0,70	BPMR6A	6726	08 5063
TBC 4200 D	0,60	BPMR6A	6726	08 5063
TBC 4500 Mot. 20cc	0,60	BPM6A	7021	08 5063
TBC 4501	0,70	BPMR6A	6726	08 5063
TBC 5000	0,60	BPM6A	7021	08 5063
TBC 5500	0,80	BPM6A	7021	08 5063
TCG 24 EASPSL	0,80	BMR7A	4226	10 6793
TCG 40 EASLP / EASP	0,70	BPMR6A	6726	08 5063
THT 16 / 23 / 162 / 200	0,80	BM6A	5921	01 5478
THT 210 S	0,80	BPM6A	7021	08 5063
THT 212 / 230 / 232	0,80	BM6A	5921	01 5478
THT 240 Mot. 21cc	0,80	BPM6A	7021	08 5063
THT 262 Mot. 26cc	0,80	BM6A	5921	01 5478
THT 2000, THT 2100 & 2120 Mot. 21cc	0,80	BPM6A	7021	08 5063
THT 2510 / 2520 / 2530 / 2540 - Mot. 24cc	0,80	BPM6A	7021	08 5063
TLE 500 / 550	0,70	BM7A	6521	10 6793
TPE 250	0,80	BPM6A	7021	08 5063
TPE 250 PF	0,60	BM7A	6521	10 6793
TPE 260 PF	0,70	BM7A	6521	10 6793
TPE 270 PF / PN	0,60	BPM7A	7321	02 5959
TPE 2100 / 2110 / 2410	0,70	BPM6F	5950	- -
TPE 2501	0,60	BM7A	6521	10 6793
TPH 230 S / SS, TPH 250 PF, TPH 260 P	0,80	BMR6A	7421	01 5478
TPH 270 PF Mot. 26cc	0,60	BPM7A	7321	02 5959
TPH 270 S / SS, TPH 2501 / S / SS	0,80	BMR6A	7421	01 5478
TST 218	0,80	BM6A	5921	01 5478
TUM 220 / 250	0,60	BPM6A	7021	08 5063

TANAKA - Générateurs

AQB 381	0,60	B6S	3510	09 6048
AQB 600, DEG 600, DMD 430	0,60	B7S	3710	- -
EC 11	0,60	BM6A	5921	01 5478
ECU 3801	0,60	BPM7A	7321	02 5959
EHC 120, EHC 506	0,60	BM7A	6521	10 6793
HMD, JD 37	0,60	B7S	3710	- -
JEA 37	0,60	B6S	3510	09 6048
JEA 50 / 500	0,60	BM6A	5921	01 5478
LEG 1200	0,60	B6S	3510	09 6048
ME 301 / 303 / 304 / 430	0,60	B7S	3710	- -
N 301	0,60	BM7A	6521	10 6793
N 303	0,60	BM7	6321	- -
PCP 3 Type SD	0,60	B6S	3510	09 6048
PF 2500	0,70	BPMR7A	4626	02 5959
PF 2600	0,60	BPMR7A	4626	02 5959
PF 3000 / 3300	0,70	BPMR7A	4626	02 5959
PF 4000 / 4010 / 4210, PM 2100	0,60	BPM6A	7021	08 5063
QBM 23	0,60	BM6A	5921	01 5478
QBM 23 DX/N	0,60	B6S	3510	09 6048
QCP 12 / 121	0,60	BM6A	5921	01 5478
QCP 381	0,60	B6S	3510	09 6048
QEG 250 / 300, QS 22	0,60	BM6A	5921	01 5478
REG 80	0,60	B6S	3510	09 6048
REG 600 / 800 / 1000, S 3, SAC 30B	0,60	B7S	3710	- -
SEG 100	0,60	B6S	3510	09 6048
SEG 221	0,70	B6HS	4510	- -
SHC 30B, SMC 30B	0,60	B7S	3710	- -
ST 16	0,60	BM7	6321	- -
T 16	0,60	BM6A	5921	01 5478
T 321 / 322 / 323	0,60	BM7A	6521	10 6793
TBC 270 PF	0,60	BMR7A	4226	10 6793
TBC 355 / 422	0,60	BM7A	6521	10 6793
TBC 430 PF	0,50	BPMR7A	4626	02 5959
TBC 500 / 2200	0,60	BPM6A	7021	08 5063
TBC 2211 / 2251	0,70	BPMR6A	6726	08 5063
TBC 2400 / 4200	0,60	BPM6A	7021	08 5063
TBH 2500	0,60	BM7A	6521	10 6793
TBL 300 / 450	0,60	B7S	3710	- -
TBL 455 / 500	0,60	BM7A	6521	10 6793
TC 47 / 220 / 401 / 402 / 422	0,60	BPM6A	7021	08 5063
TC 47 R	0,70	BPMR6A	6726	08 5063
TC 218 / 262 / 265	0,60	BM6A	5921	01 5478
TC 355	0,60	BMR7A	4226	10 6793

Modèle

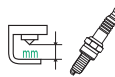
 N° STOCK BOÎTE
 N° BLISTER
 N° STOCK BLISTER

TANAKA - Générateurs				
TC 2300 / 4700	0,70	BPMR6A	6726	08 5063
TCP 25	0,60	BPM7A	7321	02 5959
TOP 38 / 381	0,60	B6S	3510	09 6048
TEA 30	0,60	B7S	3710	- -
TEA 302	0,60	BM7A	6521	10 6793
TEA 500, TED 23	0,60	BM6A	5921	01 5478
TED 210	0,60	BPM6A	7021	08 5063
TED 232 / 260 / 262 / 265, THB 300, THT 210 / 230	0,60	BM6A	5921	01 5478
THT 240	0,60	BPM6A	7021	08 5063
THT 262	0,60	BM6A	5921	01 5478
THT 1800 / 2510 / 2520 / 2530	0,70	BPMR6A	6726	08 5063
TIA 30 / 302 / 305, TLE 500 / 550	0,60	BM7A	6521	10 6793
TOB 120 / 175 / 300	0,60	BMR6A	7421	01 5478
TOB 550	0,60	BPR7HS	6422	- -
TSD 23	0,60	BM6A	5921	01 5478

TANAKA - Outils Divers

JEA 50	0,60	BMR6A	7421	01 5478
Moby X 24, Moby X 26	0,70	BPMR7A	4626	02 5959
PB-SE 802	0,60	BM7A	6521	10 6793
PB-SE 803	0,70	BPM6A	7021	08 5063
PB-SM 802	0,70	BM7A	6521	10 6793
PB-SM 833, PK-SE 2033	0,70	BPMR7A	4626	02 5959
PK-SE 2035	0,60	BM7A	6521	10 6793
PM 21	0,50	BPMR6A	6726	08 5063
TEA 500	0,60	BM6A	5921	01 5478
THB 260 PF	0,60	BM7A	6521	10 6793
THB 260 PFVS	0,60	BMR7A	4226	10 6793
THB 2100	0,70	BM6F	6221	11 7683
THB 2500 / 2510 / 2510 V	0,60	BPMR6A	6726	08 5063
TPB 350 GX	0,70	BM7A	6521	10 6793
TPB 400 GX	0,70	BPM6A	7021	08 5063
TPH 2211	0,60	BPMR6A	6726	08 5063
TPK 400 GS, TPK 470 GS	0,60	BPM6A	7021	08 5063
TRB 24 EAP	0,70	BMR7A	4226	10 6793
TRB 65 EF	0,70	BPMR7A	4626	02 5959

TANAKA - Tronçonneuses

50	0,60	B-2	3110	- -
EBC-1 / ECS-3 / ECS-5	0,80	BR6S	3522	09 6048
ECS-35 / 35B / 35E	0,60	BM6A	5921	01 5478
ECS-290	0,70	BMR6A	7421	01 5478
ECS-300	0,70	BM6A	5921	01 5478
ECS-307 / 350	0,60	BMR6A	7421	01 5478
ECS-320 Mot. 32,3cc, ECS-330, ECS-351	0,70	BM6A	5921	01 5478
ECS-355	0,60	BM6A	5921	01 5478
ECS-356	0,70	BM6A	5921	01 5478
ECS-357	0,60	BM6A	5921	01 5478
ECS-370	0,60	BM7A	6521	10 6793
ECS-405 (->85)	0,70	BM7A	6521	10 6793
ECS-405 (86->)	0,70	BM6A	5921	01 5478
ECS-415 (->85)	0,70	BPM7A	7321	02 5959
ECS-415 (86->)	0,70	BM6A	5921	01 5478
ECS-505 / 506	0,70	BPMR6A	6726	08 5063
ECS-650 Mot. 63cc, ECS-655	0,70	BPM7A	7321	02 5959
ECS-3301 / 3351 - Mot. 32,3cc	0,60	BM6A	5921	01 5478
ECS-3301 B	0,70	BM6A	5921	01 5478
ECS-3500 / 3500B / 4000, ECS-4000B 40cc	0,70	BPM6A	7021	08 5063
ECS-3801	0,80	BPM7A	7321	02 5959
ECT-3401 / 3801 / 6501	0,50	BPMR7A	4626	02 5959
ECV-3400 / 3801 / 4501 (24cc)	0,50	BPMR7A	4626	02 5959
ECV-4501 39cc (S/N V001001)	0,60	BPMR7A	4626	02 5959
ECV-5601	0,60	BPMR8Y	2218	- -
EHC-140	0,70	BPMR6A	6726	08 5063
EHG-120	0,60	BMR6A	7421	01 5478
ES-650/20, ES-650/24, ES-655	0,70	BPMR6A	6726	08 5063
ESC-355	0,50	BMR6A	7421	01 5478
ESC-415	0,50	BPMR7A	4626	02 5959
Mot. Kawasaki	0,70	BM7A	6521	10 6793
QUM-2	0,80	BR6S	3522	09 6048
SP-37 / 351 / 411	0,70	BPM6A	7021	08 5063
SP-502	0,70	BM6A	5921	01 5478
TCS-33 EB	0,70	BPMR6A	6726	08 5063

Modèle

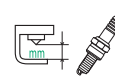
 N° STOCK BOÎTE
 N° BLISTER
 N° STOCK BLISTER

TCS-40 EA	0,70	BPMR7A	4626	02 5959
TCS-506 / 650 / 655 / 3410	0,70	BPM7A	7321	02 5959
TCS-3301PFS / 3351PFS	0,60	BPM6A	7021	08 5063
TCS-3401	0,70	BPM7A	7321	02 5959
TPS-250 PN / 270 PN / 270 PF	0,60	BPMR7A	4626	02 5959
TPS-260 PF	0,70	BM7A	6521	10 6793
TPS-2501	0,60	BMR7A	4226	10 6793
TPS-2510	0,60	BPMR6A	6726	08 5063

TAS - Tronçonneuses

ECS 3, EBC 1, QUM 2	0,60	BR6S	3522	09 6048
TBS 23, TBC 30, ECS 25	0,60	BM7A	6521	10 6793

TAYLOR - Manutention

TC200-300 - Mot. Chrysler	0,70	BPR4ES	7222	- -
TC200-300 - Mot. Ford, TY100-150	0,80	WR5	2438	- -
Yardster	0,60	A6FS	2210	- -

TECHNOID - Manutention

Wilkra	0,60	B6S	3510	09 6048
--------	------	-----	------	---------

TECNAMOTOR - voir ASPERA - Générateurs

TECUMSEH - Générateurs

A 220 4,8PS (95-)	0,60	BR2-LM	5798	06 4740
AH 480 3,9 hp	0,70	B6S	3510	09 6048
AH 520 2,25 hp	0,70	BP-4	2911	- -
AH 600 3 hp	0,70	BPM6A	7021	08 5063
AH 817 5 hp	0,70	B6S	3510	09 6048
ALN 330 7,2PS (95-)	0,60	BR2-LM	5798	06 4740
AV 520 2,75 hp	0,70	B4-LM	3410	05 4358
AV 520 3hp	0,70	B2-LM	1147	06 4740
AV 600 5 hp	0,70	B6S	3510	09 6048
BH 35 3,5PS (95-) / 37 / 40 4PS (95-)	0,60	BR2-LM	5798	06 4740
BH 153 / 173	0,60	BR4-LM	4133	05 4358
BV 153, BVL 153	0,60	BR2-LM	5798	06 4740
BVL 173 / 198	0,60	BR4-LM	4133	05 4358
BVS 143 / 153	0,60	BR2-LM	5798	06 4740
Centura 40 S / V, 45 S, 50 LX / V, 55 LX / V	0,60	BR2-LM	5798	06 4740
Futura	0,70	BR2-LM	5798	06 4740
Geotec 37 / 40	0,60	BR2-LM	5798	06 4740
Geotec 45 / 50 / 60 / 65	0,60	BR7ES	5122	- -
H 25 2,5 hp, H 30 3 hp	0,70	B6S	3510	09 6048
H 35, H 50, H 60, H 70, H 80	0,60	BR4-LM	4133	05 4358
H 35 3,5 hp, H 50 5 hp, H 60 6 hp, H 70 7 hp	0,70	B6S	3510	09 6048
H 80 8 hp, H 840 4 hp	0,70	B6S	3510	09 6048
HB Series	0,70	BR2-LM	5798	06 4740
HH 40 4 hp, HH 50 5 hp, HH 60 6 hp, HH 80 8 hp	0,70	B6S	3510	09 6048
HH 100	0,60	B6HS	4510	- -
HH 100 10 hp	0,70	B6S	3510	09 6048
HH 120 12 hp	0,70	B2-LM	1147	06 4740
HH 130 13hp / 140 14hp / 150 15hp / 160 16hp	0,70	B6HS	4510	- -
HH 180 18 hp	0,70	B7ES	1111	- -
HMM 80 8 hp	0,70	B6S	3510	09 6048
HM 70 / 80 / 100	0,60	BR4-LM	4133	05 4358
HM 70 7 hp, HM 80 8 hp	0,70	B6S	3510	09 6048
HMSK70 -> 110 Series	0,70	BR2-LM	5798	06 4740
HMXL 80 8PS (95-)	0,60	BR2-LM	5798	06 4740
HR 70 7 hp	0,70	B6S	3510	09 6048
HS 40 / 50	0,60	BR4-LM	4133	05 4358
HSK 30 -> 70 Series	0,70	BR2-LM	5798	06 4740
HSK 600 -> 850 Series	0,70	BPMR6A	6726	08 5063
HXL 35 3,5 hp, LAV 30 3 hp	0,70	B6S	3510	09 6048
LAV 35, LAV 40, LAV 50	0,60	BR4-LM	4133	05 4358
LAV 35 3,5 hp, LAV 40 4 hp, LAV 50 5 hp	0,70	B6S	3510	09 6048
LEV 100 / 115 / 120	0,70	BR2-LM	5798	06 4740
MV 100 / 100 S	0,60	BR4-LM	4133	05 4358
MV 100 S 3,5PS (95->)	0,60	BR2-LM	5798	06 4740
OH 120 12 hp / 140 14 hp / 150 15 hp / 160 16 hp	0,70	B6HS	4510	- -
OH 180 18 hp	0,70	B7ES	1111	- -
OHH 45 -> 65 Series, OHSK 50 -> 90 Series	0,70	BR7ES	5122	- -
OHSK 120 / 125 Series	0,70	BR7ES	5122	- -
OHV 4 tps 12,5PS (95-)	0,60	B7S	3710	- -

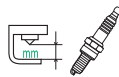

Modèle		N° STOCK BOÎTE	N° BLISTER	N° STOCK BLISTER
OVM 120 12 hp	0,70	B6HS	4510	-
OVRM 40 / 50	0,60	BR7ES	5122	-
OVRM 55 -> 105 Series	0,70	BR7ES	5122	-
OVXL 120, OVXL-C 125	0,60	B6HS	4510	-
Premier 45 OHV /153 / 173	0,60	BR4-LM	4133	05 4358
Premier 55 OHV	0,60	BR7ES	5122	-
Prisma, Prisma Démarrage Electrique	0,60	BR4-LM	4133	05 4358
Prisma 3.7 PS, 5PS (95->)	0,60	BR2-LM	5798	06 4740
RV 173	0,60	BR4-LM	4133	05 4358
Spectra	0,70	BR2-LM	5798	06 4740
Synergy 55 OHV	0,60	BR7ES	5122	-
TC 200 1.4 hp	0,70	BPM6A	7021	08 5063
TC 300 1.8 hp	0,70	BPM7A	7321	02 5959
TNT 100 / 120	0,60	BR4-LM	4133	05 4358
TNT 120 12 hp, TV 975 3 hp	0,70	B2-LM	1147	06 4740
TV 990 3.5 hp	0,70	B4-LM	3410	05 4358
TVM 125 5 hp	0,70	B6S	3510	09 6048
TVM 140 / 170 / 195 / 220	0,60	BR4-LM	4133	05 4358
TVM 140 6 hp / 170 7 hp / 95 8 hp / 220 10hp	0,70	B6S	3510	09 6048
TVS 75 / 90	0,60	BR4-LM	4133	05 4358
TVS 100 3.9 hp / 105 4 hp / 20 5 hp	0,70	B2-LM	1147	06 4740
TVS 105 / 115 / 120	0,60	BR4-LM	4133	05 4358
TVS 520 2.75 hp / 600 3.25 hp	0,70	B4-LM	3410	05 4358
TVS 840 4 hp	0,70	BPM6A	7021	08 5063
TVX 105 4 hp	0,70	B2-LM	1147	06 4740
TVXL	0,60	BR4-LM	4133	05 4358
TVXL 105 / 115 / 840 Series	0,70	BR2-LM	5798	06 4740
TVXL 195 4tps 8PS (95-)	0,60	BR2-LM	5798	06 4740
TVXL 840 4 hp	0,70	BPM6A	7021	08 5063
TVXL 840 5PS (95-)	0,60	BR2-LM	5798	06 4740
V 50 / 60 / 70 / 80	0,60	BR4-LM	4133	05 4358
V 50 5 hp / 60 6 hp / 70 7 hp / 80 8 hp	0,70	B6S	3510	09 6048
Vantage, Vantage 35	0,60	BR4-LM	4133	05 4358
Vantage 3,5PS (95-), Vantage 35 & 37 Eco-Tec	0,60	BR2-LM	5798	06 4740
Vantage 40	0,60	BR4-LM	4133	05 4358
VH 40 4hp / 50 5hp / 60 6hp / 70 7hp / 100 10hp	0,70	B6S	3510	09 6048
VLV 55 / 65 / 66 Series	0,70	BR2-LM	5798	06 4740
VM 70 / 80 / 100	0,60	BR4-LM	4133	05 4358
VM 70 7 hp / 80 8 hp / 100 10 hp	0,70	B6S	3510	09 6048

TECUMSEH - Outils Divers

CH 133	0,50	BR2-LM	5798	06 4740
Enduro 9-11 EC OHV 4 tps, Enduro 11-13hp	0,80	BR7ES	5122	-
Enduro 11-13.5 & 15-18 OHV 4 tps	0,80	BR7ES	5122	-
Enduro OV691EA & OV691EP 18-22 OHV 4 tps	0,80	BR7ES	5122	-
Enduro XL OV 195 OHV 4 tps	0,80	BR7ES	5122	-
Enduro XL OV691EP 23-25 OHV 4 tps	0,80	BR7ES	5122	-
Formula 8-10	0,50	BR2-LM	5798	06 4740
Formula 9-11 & 10-13 & 14-17.5 OHV 4 tps	0,80	BR7ES	5122	-
Formula OV 195 OHV 4 tps	0,80	BR7ES	5122	-
Formula OV 691EA & 691EP 18-20 OHV 4 tps	0,80	BR7ES	5122	-

TECUMSEH - Tronçonneuses

AH440 / 470 / 480 / 490 / 520 / 580	0,70	B4	3210	-
AH750	0,90	BP6S	3111	-

TERRILL - Tronçonneuses

24000A	0,60	BM7A	6521	10 6793
60, CS6, CS7	0,70	B4L	3112	-

THEW-LORAIN - Manutention

Front End Loader	0,60	AB-6	2910	-
------------------	------	------	------	---

TIELBURGER - Tondeuses

Mot. B&S	0,70	BR2-LM	5798	06 4740
----------	------	--------	------	---------

TIGER - Tondeuses

Mot. B&S	0,70	BR2-LM	5798	06 4740
----------	------	--------	------	---------

TILLISON - Tondeuses

Mot. Honda OHV 13 hp	0,80	BPR5ES	7422	03 6854
----------------------	------	--------	------	---------

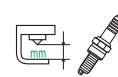

TOHATSU - Générateurs

450AA-G/BM-G, L2500 (S) / BA-G, L2800AA-G	0,60	B7HS	5110	-
L2500BM-G, L3000AA-G/AM-G	1,00	BP7HS-10	7829	-
T43G	0,60	B6S	3510	09 6048
T50/E/F/G	0,60	B7S	3710	-
T56E	0,60	B-4	3210	-
T65/C4	0,60	B7S	3710	-
TRC-1-75, TRC-3-75	0,60	B7HS	5110	-
TRC-IM/IIIM/2MK	1,00	BP7HS-10	7829	-
V20BA-G/BM-G, V20JB2	0,60	B7HS	5110	-
V20JA	0,60	B7S	3710	-
V30JA, V38BA-G/BM-G, V46AM-G	0,60	B7HS	5110	-
V50CA-G, V60AA-G, V75CA-G	0,60	B7HS	5110	-
V75EM-G	1,00	BP7HS-10	7829	-

TOMOS - Générateurs

Kooper	0,60	B6HS	4510	-
--------	------	------	------	---

TONDU - Débroussailleuses

11, 12, 13, 14	0,70	BPMR7A	4626	02 5959
16 / 22cc	0,70	BM7A	6521	10 6793
18, 19, 20, 24, 25, 33, 35, 40, 48	0,60	BM6A	5921	01 5478
35cc	0,50	BMR6A	7421	01 5478
41AD 280 / 41AD Y28	0,50	BPMR6F	1270	-
200, 260 / D, 400A, 460AVS	0,70	BPMR7A	4626	02 5959
599 / 609 / 698	0,60	BM6A	5921	01 5478
1000	0,60	B6HS	4510	-
1400, 1500, 1600, 1700, 1900, 4000, 5000	0,80	BM4A	5628	-
1926, 1927	0,70	BMR6A	7421	01 5478
1930, 1931, 1932	0,80	BM4A	5628	-
8420, 8510, 8515	0,70	BPMR7A	4626	02 5959
153001	0,60	BPMR6F	1270	-
152501, 152525, 152536, 153500, 153502, 153503	0,60	BPMR6A	6726	08 5063
153504, 153535, 154902, 154949, 154950	0,60	BPMR6A	6726	08 5063
154900, 154950LE, 154950LW	0,60	BPMR7A	4626	02 5959
51620, 51638, 51652, 51653, 51660, 51675	0,70	BMR6A	7421	01 5478
51903, 51906, 51908, 51909, 51911, 51916, 51918	0,80	BPMR6F	1270	-
51930 / 51932 / 51934 Mot. Full Crank Toro 1 hp	0,70	CMR7A	7543	-
53002, 53003, 53010, 53011	0,70	BPMR7A	4626	02 5959
53020, 53030, 53040, 53201	0,70	BPMR7A	4626	02 5959
AD16D	0,60	BM6A	5921	01 5478
Autres modèles	0,60	BMR6A	7421	01 5478
BC 153E-1 / BC 174E	0,50	BMR6A	7421	01 5478
BC 153E1, BC 174E	0,70	BMR6A	7421	01 5478
BC 161 DM / 241 DX / 330 DX / 400 FX	0,60	BM6A	5921	01 5478
BC 234 B	0,60	BM7A	6521	10 6793
BC 250DL, 260 / DUM / DWM	0,70	BM7A	6521	10 6793
BC 324B / FB 26 / FBC 12	0,80	BR6HS	3922	-
BC 430 / DWM / FWM, 254E, BK 340FI	0,70	BPMR6A	6726	08 5063
BCZ2602DL, EXZ2600DL, SGCZ2600DL/W	0,70	CMR7A	7543	-
BCZ2610DL - Mot. GZ25N	1,00	CMR7H-10	1656	-
BCZ3205DL & BCZ3205DW - Mot. GZ30N	1,00	CMR7H-10	1656	-
BK 331 FX / TM 350	0,60	BM6A	5921	01 5478
BKZ305ODL - Mot. GZ30N	1,00	CMR7H-10	1656	-
BKZ5010	0,70	CMR7H	3066	-
BTS 9 / 10	0,70	BPMR7A	4626	02 5959
BS 700	0,50	BR6HS	3922	-
D18	0,70	B6S	3510	09 6048
DB 23 / 24 / 28 / 33 / 47 / 49, CBT 45	0,70	BPMR7A	4626	02 5959
DTC27 Mot. Kawa. TJ27E, DTC35 Mot. TJ35E	0,70	BPMR7A	4626	02 5959
DTC45 Mot. Kawasaki TJ45E	0,70	BPMR7A	4626	02 5959
DTC53 Mot. Kawasaki TJ53E	0,70	BPMR8Y	2218	-
E6 / E8 Mot. Robin	0,60	BM6A	5921	01 5478
E6 Mot. Kawasaki	0,50	BM4A	5628	-
EXZ2610DL - Mot. GZ25N	1,00	CMR7H-10	1656	-
FB 26, FBC 12 / 26	0,80	BR6HS	3922	-
FBC 33	0,70	BR6S	3522	09 6048
G230, 2000T, PSZ2600	0,70	CMR7A	7543	-
GE 21	0,60	BPM6A	7021	08 5063
GHT 17 / 22	0,70	BPMR6A	6726	08 5063
GTI 15 / 16 / 17 / 18 / 19 / 52	0,80	BM4A	5628	-
HB2301, HBZ2600/1	0,70	CMR7A	7543	-
HP 22 / 28 / 30	0,80	BM4A	5628	-
KD 18 / 24X / 33XV, SU 18 D	0,60	BM6A	5921	01 5478

Modèle		N° STOCK	N° BLISTER	N° STOCK
		BOÎTE	BLISTER	BLISTER

TONDU - Débroussailluses				
KD 40 XV / 50 XV - Mot. Robin	0,60	BM6A	5921	01 5478
L1840F, L1840G	0,70	BMR6A	7421	01 5478
L1840K Mot. Kawasaki 18.4cc	0,60	BM6A	5921	01 5478
L1845G, L2035G, L2415G, L2515K, L2515X	0,70	BMR6A	7421	01 5478
L2035G Mot. Kawasaki 20.3cc	0,60	BMR6A	7421	01 5478
L2515K Mot. Kawasaki 25.1cc	0,60	BM6A	5921	01 5478
L2540K, L2815G, L2815G3	0,70	BMR6A	7421	01 5478
L2815G & L2815K Mot. Kawasaki 28.1cc	0,60	BM6A	5921	01 5478
L333563, L3335G, L3335G1	0,70	BMR6A	7421	01 5478
L4320K Mot. 43.2cc Kawasaki	0,60	BM6A	5921	01 5478
LRTZ2600, SRTZ2600, SRTZ2601F	0,70	CMR7A	7543	- -
LT 7000 / 7500	0,60	BPM6A	7021	08 5063
M18, Pro 255, S 180 / 255 / 260	0,60	BM6A	5921	01 5478
Mot. B&S	0,70	B2-LM	1147	06 4740
Mot. B&S 3.5 hp	0,70	BR2-LM	5798	06 4740
Mot. B&S Quantum 5 hp	0,80	BR2-LM	5798	06 4740
Mot. Fuji	0,60	B6HS	4510	- -
Mot. Kawasaki, Mot. Kioritz	0,60	BM6A	5921	01 5478
Mot. Kohler	0,70	B-6L	3212	- -
Mot. Tecumseh	0,70	BR4-LM	4133	05 4358
Pro 851	0,60	BMTA	6521	10 6793
SGCZ2610DL & SGCZ2610DW - Mot. GZ25N	1,00	CMR7H-10	1656	- -
SST 45, TBC 57	0,80	BM4A	5628	- -
TC 1000 / 2000 / 3100 / 3500 / 5000	0,70	BMR6A	7421	01 5478
TD24 / 33, TDF18	0,60	BM6A	5921	01 5478
TE22F / R, TE26 / TE30, TE40 / GT, TE41	0,70	BPMR7A	4626	02 5959
Tous modèles	0,70	BMR6A	7421	01 5478
UV-EB	0,60	BMR6A	7421	01 5478
UV-P	0,60	BR7HS	4122	- -
Weed Eater	0,60	BM6A	5921	01 5478
X3335G	0,70	BMR6A	7421	01 5478
XR 20 / 30 / 50 / 70 / 75 / 80 / 90 / 95	0,80	BM4A	5628	- -
XR 100 / 105 / 125	0,80	BM4A	5628	- -
XR 200	0,60	BM6A	5921	01 5478
XT 20	0,80	BM4A	5628	- -
XT 25	0,70	BPMR7A	4626	02 5959
XT 30	0,60	BPM6A	7021	08 5063
XT 40 / 50 / 85 / 90 / 100 / 125	0,80	BM4A	5628	- -

TONDU - Tronçonneuses				
30F, 35F, 42F	0,80	BPMR7A	4626	02 5959

TOPFLITE - Tondeuses				
Mot. B&S	0,70	BR2-LM	5798	06 4740
Mot. Tecumseh	0,70	BR6S	3522	09 6048

TOPSO - Tronçonneuses				
E 380 Super	0,60	BM6A	5921	01 5478
E 500AV / 501AV / 510AVB / 511AVB	0,50	BPMR6A	6726	08 5063
E 600AV	0,50	BR6HS	3922	- -
E 601AV / 610AVB / 611AVB / 700AV / 710AVB	0,50	BPMR6A	6726	08 5063

TORO - Générateurs				
T 300 D / 400D / 2500	0,60	BPR4HS	7823	- -

TORO - Outils Divers				
Dingo Series Mot. Kohler Command Pro 20 & 22hp	0,70	BKR5ES	2460	07 4803
Dingo Series Mot. Kohler Command Pro 25hp	0,70	BKR5ES	2460	07 4803
Model ME Continental F227	0,60	AB-6	2910	- -
Mot. Ford OHV 6 Cyl.	0,60	B-6L	3212	- -
Series 5 Continental F227	0,60	AB-6	2910	- -
Series 6 Mot. Chevrolet 250 ci.	0,90	WR5	2438	- -

TORO - Tondeuses				
20005, 20016, 20017, 20047, 20053 -> 20056	0,70	BR2-LM	5798	06 4740
20057 Super Recycler	0,80	BKR5E	7938	07 4803
20058 / 20070 / 20073 Recycler	0,70	BR2-LM	5798	06 4740
20199, 20200 Mot. B&S OHV 190cc 8.75hp	0,50	BKR5ES	2460	07 4803
20316, 20352 Mot. B&S 190cc 6.5hp	0,50	BKR5ES	2460	07 4803
20318, 20370, 20371 Mot. Kohler OHV 149cc	0,70	DCPR6E	3481	- -
20332, 20333, 20334 Mot. B&S 190cc 6.5hp	0,50	BKR5ES	2460	07 4803

Modèle		N° STOCK	N° BLISTER	N° STOCK
		BOÎTE	BLISTER	BLISTER

20376, 20377, 20378 Mot. Kohler OHV 149cc	0,70	DCPR6E	3481	- -
20382 Mot. Honda GVC 160cc	0,70	BPR6ES	7822	04 7678
30074 & 30078 Mot. Kawa. FS481V 603cc 14.5hp	0,80	BPR4ES	7222	- -
30488 & 30489 Mot. Kawasaki 603cc 18.5hp	0,80	BPR4ES	7222	- -
30632 & 30634 Mot. Kawa. FS481V 603cc 14.5hp	0,80	BPR4ES	7222	- -
30638 & 30672 Mot. Kawa. FS481V 603cc 14.5hp	0,80	BPR4ES	7222	- -
30674 & 30678 Mot. Kawa. FS481V 603cc 14.5hp	0,80	BPR4ES	7222	- -
30934 & 30938 Mot. Kawa. FS481V 603cc 14.5hp	0,80	BPR4ES	7222	- -
39074 & 39078 Mot. Kawa. FS481V 603cc 14.5hp	0,80	BPR4ES	7222	- -
39488 Mot. Kawasaki 603cc 18.5hp	0,80	BPR4ES	7222	- -
39934 & 39938 Mot. Kawa. FS481V 603cc 14.5hp	0,80	BPR4ES	7222	- -
74141 Mot. Kawa. FX Series 726cc 20.5hp	0,80	BPR4ES	7222	- -
74143 Mot. Kawa. FX Series 726cc 22hp	0,80	BPR4ES	7222	- -
74145 Mot. Kawa. FX Series 726cc 23.5hp	0,80	BPR4ES	7222	- -
74534 & 74536 Mot. Kawa. FS 603cc 15hp	0,80	BPR4ES	7222	- -
74549 Mot. Kawasaki FS 726cc 23hp	0,80	BPR4ES	7222	- -
74553 Mot. Kawasaki FS 726cc 24hp	0,80	BPR4ES	7222	- -
74578 Mot. Kawasaki FS 726cc 22hp	0,80	BPR4ES	7222	- -
74583 Mot. Kohler Command EFI 747cc 27hp	0,70	BKR5ES	2460	07 4803
74589 Mot. Kohler Command EFI 747cc 25hp	0,70	BKR5ES	2460	07 4803
74901 Mot. Kohler Command 674cc 23hp	0,70	BKR5ES	2460	07 4803
74903 Mot. Kohler Command 725cc 25hp	0,70	BKR5ES	2460	07 4803
74906 Mot. Kohler Comm. Pro EFI 747cc 27hp	0,70	BKR5ES	2460	07 4803
74915 & 74916 Mot. Kohler Command 725cc 27hp	0,70	BKR5ES	2460	07 4803
74922 Mot. Kawasaki FX 726cc 22hp	0,80	BPR4ES	7222	- -
74923 Mot. Kawasaki 852cc 24.5hp	0,80	BPR4ES	7222	- -
74925 & 74927 Mot. Kawa. 852cc 25.5hp	0,80	BPR4ES	7222	- -
74926 & 74928 Mot. Kohler EFI 747cc 29hp	0,70	BKR5ES	2460	07 4803
74930 Mot. Kohler Command 747cc 27hp	0,70	BKR5ES	2460	07 4803
74936 & 74938 Mot. Kohler Comm. Pro 999cc 34hp	0,70	BKR6E	6962	- -
74951 & 74952 Mot. Kawa. FX Series 726cc 20.5hp	0,80	BPR4ES	7222	- -
74953 Mot. Kawa. FX Series 726cc 22hp	0,80	BPR4ES	7222	- -
74954 Mot. Kawa. FX Series 726cc 23.5hp	0,80	BPR4ES	7222	- -
74956 Mot. Kohler Comm. Pro EFI 747cc 27hp	0,70	BKR5ES	2460	07 4803
74975, 74977 Mot. Kawasaki FX801V 852cc	0,80	BPR4ES	7222	- -
GT2200 Mot. Kohler Cour. Twin 725cc 25hp	0,70	BKR5ES	2460	07 4803
GTS / Lawn-Boy / 2 tps	0,70	BPMR6A	6726	08 5063
LX423 Mot. Kohler Courage 597cc 20hp	0,70	BKR5ES	2460	07 4803
LX427 Mot. Kohler Courage 597cc 20hp	0,70	BKR5ES	2460	07 4803
LX468 Mot. Kohler Courage Twin 725cc 22hp	0,70	BKR5ES	2460	07 4803
Mot. Aspera	0,60	B4-LM	3410	05 4358
Mot. B&S (122000 / 124000 Series)	0,60	BMR6A	7421	01 5478
Mot. B&S (130000 Series)	0,50	B2-LM	1147	06 4740
Mot. B&S OHV 5.5 / 6 / 6.5hp	0,90	BKR5E	7938	07 4803
Mot. B&S OHV 14 / 16 / 17 / 18hp	0,60	BKR5ES	2460	07 4803
Mot. B&S Vanguard	0,90	BKR5E	7938	07 4803
Mot. Echo	0,60	BMR6A	7421	01 5478
Mot. Ford 1.1L	0,80	BPR6ES	7822	04 7678
Mot. Ford 1.3L	0,90	BPR6EFS	3623	- -
Mot. Kawasaki 12.5hp	0,60	BMR6A	7421	01 5478
Mot. Kawasaki 27hp	0,80	BPR2ES	2264	- -
Mot. Kawasaki FB460V 12.5hp	0,60	BMR6A	7421	01 5478
Mot. Kawasaki FE120D 4hp	0,70	BPR5ES	7422	03 6854
Mot. Kawasaki FH 451V / 500V	0,70	BPMR6A	6726	08 5063
Mot. Kawasaki OHV 3.7 / 6 / 13 / 14hp	0,70	BPR5ES	7422	03 6854
Mot. Kawasaki OHV V-Twin 15 / 17hp	0,70	BPMR6A	6726	08 5063
Mot. Kawasaki OHV 17hp	0,70	BPMR6A	6726	08 5063
Mot. Kawasaki Twin OHV 25hp	0,60	BPR4ES	7222	- -
Mot. Kawasaki V-Twin 20 / 22hp	0,60	BMR6A	7421	01 5478
Mot. Kawasaki V-Twin 23 / 27hp	0,80	BPR5ES	7422	03 6854
Mot. Kioritz	0,80	BMR6A	7421	01 5478
Mot. Kohler Command 15hp	1,00	BKR5ES-11	2382	- -
Mot. Kohler Command 18hp	0,60	BKR5ES	2460	07 4803
Mot. Kohler Command Pro 20 / 23 / 27 / 28hp	0,60	BKR5ES	2460	07 4803
Mot. Kohler K321 14hp / K532 20hp / K582 23hp	0,60	B-6L	3212	- -
Mot. Kohler KT17, M14, Magnum Twin	0,60	B-6L	3212	- -
Mot. Kohler OHV 22hp	0,60	BKR5ES	2460	07 4803
Mot. Mitsubishi 24 / 27hp	0,80	BPR5FS	2423	- -
Mot. Onan	0,80	BR6ES	4922	- -
Mot. Onan B48G / Twin	0,80	BPR5EFS	2223	- -
Mot. Onan NHB	0,60	B4-LM	3410	05 4358
Mot. Onan OHV	0,80	BR6ES	4922	- -
Mot. Suzuki 2 tps	0,70	BPMR4A	6028	- -
Mot. Tecumseh 6.5hp	0,70	BR2-LM	5798	06 4740
Mot. Tecumseh OVRM40 4hp	0,70	BR7ES	5122	- -
Mot. Tecumseh TNT100 3.9hp	0,70	BR2-LM	5798	06 4740
Mot. Tecumseh TVS90 / 100 3.8hp	0,70	BR2-LM	5798	06 4740

Modèle

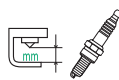

N° STOCK
BLISTER
BOÎTE

N° STOCK
BLISTER
BLISTER

Modèle		N° STOCK BOÎTE	N° STOCK BLISTER	N° STOCK BLISTER
Mot. Tecumseh TVS105 / 840 4hp	0,70	BR2-LM	5798	06 4740
Mot. Toro	0,60	BM6A	5921	01 5478
Mot. Toro Ø18 mm	0,60	AB-6	2910	- -
MX4260 Mot. Kawasaki V-Twin 726cc 23hp	0,70	BPR4ES	7222	- -
MX4880 Mot. Kawasaki 726cc 21.5hp	0,70	BPR4ES	7222	- -
MX5060 Mot. Kawasaki V-Twin 726cc 23hp	0,70	BPR4ES	7222	- -
MX5480 Mot. Kawasaki 726cc 23hp	0,70	BPR4ES	7222	- -
MX6080 Mot. Kawasaki 726cc 24hp	0,70	BPR4ES	7222	- -
SS4216, SS3200 Mot. Toro 452cc 16hp	0,60	BCPR6ES	2330	- -
SS4235 Mot. Kawasaki V-Twin 603cc	0,70	BPR4ES	7222	- -
SS4260 Mot. Kawasaki 726cc 21.5hp	0,70	BPR4ES	7222	- -
SS5000 & SS5060 Mot. Kawa. V-Twin 726cc 23hp	0,70	BPR4ES	7222	- -
Teledyne R839	0,80	BP7HS	5111	- -
Turfmaster Mot. Kawasaki FJ180V 179cc	0,80	BPR5ES	7422	03 6854
Wisconsin AENLD	0,80	AB-6	2910	- -
Workman 3100	0,80	BKR5E	7938	07 4803
Workman 3200 / 4200	0,80	BPR4ES	7222	- -
ZX4820 Mot. Kawasaki 726cc 21.5hp	0,70	BPR4ES	7222	- -
ZX5020 Mot. Kohler Courage Pro 23hp	0,70	BKR5ES	2460	07 4803
ZX5420 Mot. Kawasaki V-Twin 726cc 23hp	0,70	BPR4ES	7222	- -
ZX6020 Mot. Kawasaki 726cc 24hp	0,70	BPR4ES	7222	- -

TOURNO - Tondeuses

95 / 115 (GCV 520 Honda)	0,50	BPR5ES	7422	03 6854
--------------------------	------	--------	------	---------

TOW MOTOR - Manutention

Continental	0,60	AB-6	2910	- -
Hercules Mot. G1600	0,60	XR5	3332	- -
Waukesha	0,60	B-4	3210	- -
I.H.C. 6 Cyl.	0,60	B6S	3510	09 6048
I.H.C. 8 Cyl.	0,60	XR5	3332	- -
Mot. Caterpillar 1404	0,60	BR6S	3522	09 6048
Mot. Ford 6 Cyl.	0,80	WR5	2438	- -
Mot. Ford 8 Cyl.	0,60	AR6FS	3323	- -
Mot. Perkins G4-236	0,70	BPR5ES	7422	03 6854

TOW-MITE - Manutention

Tous modèles	0,60	B6S	3510	09 6048
--------------	------	-----	------	---------

TOYOTA - Manutention

02-2FG32, 02-2FG40, 02-2FS35 - Code Mot. 2F	0,80	BP4ES	6928	- -
02-FG32, 02-FG40 - Code Mot. F	0,80	BP4ES	6928	- -
02-FG40 - Code Mot. 3P	0,80	BP5EY	7327	- -
02-FG40 - Code Mot. 4P	0,80	BPR2ES	2264	- -
02-FS35 - Code Mot. F	0,80	BP4ES	6928	- -
2R, 3R, F, 2F	0,80	BP5EY	7327	- -
4P, 5R	0,80	BPR2ES	2264	- -
5P	0,80	BP4ES	6928	- -
7FGCU 15, 18, S20 Mot. 4Y	0,80	BPR2ES	2264	- -
40-2FG2FO - Code Mot. 5R	0,80	BP4ES	6928	- -
40-3FG10, 40-3FG15 - Code Mot. 5R	0,80	BP4ES	6928	- -
40-3FGC20, 40-3FGC25 - Code Mot. 5R	0,80	BP4ES	6928	- -
50-2FG25 - Code Mot. 5R	0,80	BP4ES	6928	- -
FG30, FGC-30 - Code Mot. 5P	0,80	BP5ES	6511	03 6854
FGC-10, FGC-15, FGC-30 - Code Mot. 5R	0,80	BP4ES	6928	- -

TRACTOR-LOADER - Manutention

TL-6 Mot. Essence	0,80	B6S	3510	09 6048
TL-10 / 11 / 12 - Allis-Chalmers G226	0,60	B5ES	6410	- -
TL-10 / 11 / 13 - Allis-Chalmers W226	0,60	B6S	3510	09 6048
TL-16	0,60	B6S	3510	09 6048

TRANSITIER - Manutention

Tous modèles	0,60	B2-LM	1147	06 4740
--------------	------	-------	------	---------

TRIMMER - Tondeuses

Rotarymower Mot. B&S 3 / 3.5 / 5 hp	0,70	BR2-LM	5798	06 4740
Rotarymower Mot. Honda 4 / 5 hp	0,80	BPR5ES	7422	03 6854
Rotarymower Mot. Honda GX160 5.5 hp	0,80	BPR6ES	7822	04 7678

TROMCA - Tondeuses

20805 Mot. B&S (Quantum/XTE) 4 / 5 hp	0,70	BR2-LM	5798	06 4740
---------------------------------------	------	--------	------	---------

Modèle

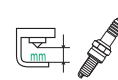

N° STOCK
BLISTER
BOÎTE

N° STOCK
BLISTER
BLISTER

Modèle		N° STOCK BOÎTE	N° STOCK BLISTER	N° STOCK BLISTER
AS 21165 / 21AB / 21A81 Mot. 4.5 / 7 hp	0,70	BR6HS	3922	- -
AS 21BS (Q) Mot. 5 hp	0,70	BR2-LM	5798	06 4740
AS 22F / 26A82 / 26A92	0,70	BR6HS	3922	- -
AS 27A82 / 27A92 / 53B1 / 53B1R Mot. 7hp	0,70	BR6HS	3922	- -
LM 21SP2K (FC180V) Mot. Kawasaki	0,80	BPR6ES	7822	04 7678
LM 21SP2S (SB152) Mot. F&S	0,70	BR6HS	3922	- -
LM 21SP3S (ST204) Mot. F&S	0,60	AB-6	2910	- -
Montana BQ5 (XM I/C) Mot. 7 hp	0,70	BR2-LM	5798	06 4740
TR 346P Mot. Tecumseh (Plasma 37)	0,70	BR4-LM	4133	05 4358
TR 500T (Q XM40)	0,70	BR2-LM	5798	06 4740
TR/T 4431BS (Sprint375)	0,70	BR2-LM	5798	06 4740
TRT 4481BQ/BOD (Q XTE50) Mot. B&S	0,70	BR2-LM	5798	06 4740
TRT/P 443(Q XM35)	0,70	BR2-LM	5798	06 4740
TRT4481K Mot. Kawasaki (FC150)	0,80	BPR6ES	7822	04 7678
TRT4481S,TRT5471S Mot. F&S (SB140SL)	0,70	BP5S	3011	- -
TRT5471BQ/D	0,70	BR2-LM	5798	06 4740
TRT5531BQ/D Mot. B&S (QXTL50/DE)	0,70	BR2-LM	5798	06 4740

TROMCA - Tronçonneuses

935F, 942, 946, 951, 999F	0,80	BPMR7A	4626	02 5959
---------------------------	------	--------	------	---------

TRONK - Tronçonneuses

Extra 38, Hobby 33, Super 33	0,60	BM6A	5921	01 5478
------------------------------	------	------	------	---------

TROY BILT - Tondeuses

Bronco / Tuffy - Mot. B&S Intek 18.5 hp	0,70	BR2-LM	5798	06 4740
Horse / SuperBronco - Mot. B&S Intek 21 hp	0,60	BKR5ES	2460	07 4803
Mot. B&S 4 / 5 / 5.5 hp	0,70	BR2-LM	5798	06 4740
Mot. B&S 6.75 hp	0,60	BKR5ES	2460	07 4803
Mot. B&S Intek OHV 6.5 hp	0,80	BKR5E	7938	07 4803
Mot. B&S OHV 9 hp, Mot. B&S Quantum 6.5 hp	0,60	BKR5ES	2460	07 4803
Mot. Honda OHC GC160 5.5 hp	0,80	BPR6ES	7822	04 7678
Mot. Honda OHV 5.5 hp	0,90	BKR5E	7938	07 4803
Mot. Tecumseh 5.5 hp	0,70	BR6S	3522	09 6048
Pony - Mot. B&S 17.5 hp	0,60	BKR5ES	2460	07 4803

TRUCK MAN - Manutention

AP - Ø18mm, Continental	0,60	AB-6	2910	- -
Kohler 4 hp.	0,80	B2-LM	1147	06 4740
Mot. Ford	0,60	B-6L	3212	- -
Mot. Winconsin	0,60	AB-6	2910	- -
NP - Ø14mm	0,60	B2-LM	1147	06 4740

TRU-CUT - Tondeuses

Mot. B&S 3 / 3.5 / 5 hp	0,70	BR2-LM	5798	06 4740
Mot. Honda 3.5 / 5 hp	0,80	BP5ES	6511	03 6854
Mot. Honda 4 / 5.5 hp	0,80	BP4ES	6928	- -

TS-INDUSTRIE - Outils Divers

Gardenmaster 10 M & 10 M-80 Mot. Kohler CH440	0,70	BKR5ES	2460	07 4803
Super Premium 30 ER Mot. Kohler CH750	0,70	BKR5ES	2460	07 4803
Tiger 25 ER Mot. Kohler CH730	0,70	BKR5ES	2460	07 4803
Wood Concept 150 M Mot. Kohler CH740	0,70	BKR5ES	2460	07 4803

TUCKER - Manutention

Sno-Cat	0,60	B6S	3510	09 6048
Mot. Chrysler 318 & 360	0,90	BPR4ES	7222	- -

TURF BLAZER - Tondeuses

Mot. Ford	0,60	B-6L	3212	- -
Mot. Kawasaki 12.5 hp	0,70	BM6A	5921	01 5478
Mot. Kawasaki 14 / 17 hp	0,80	BP5ES	6511	03 6854
Mot. Kohler 18 / 23 hp	0,80	B-6L	3212	- -
Mot. Wisconsin Twin 18 hp	0,80	AB-6	2910	- -

TURF MASTER - Tondeuses

Mot. B&S	0,70	BR2-LM	5798	06 4740
Mot. Tecumseh	0,70	BR6S	3522	09 6048

Modèle

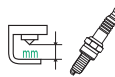
 N° STOCK BOÎTE
 N° BLISTER
 N° STOCK BLISTER

TURF POWER - Tondeuses

Mot. B&S / Tecumseh	0,70	BR2-LM	5798	06	4740
Mot. B&S Vanguard	0,80	BCPR5ES	6130	07	4803

UNITOW - Manutention

Tous modèles	0,60	AB-6	2910	-	-
--------------	------	------	------	---	---

VAP - Tondeuses

46 T37 Mot. Tecumseh (P 37)	0,70	BR4-LM	4133	05	4358
Border F4,F4A Mot. Tecumseh (P 37)	0,70	BR4-LM	4133	05	4358
Boxer F2, F2A Mot. Tecumseh (MV100S)	0,70	BR4-LM	4133	05	4358
Boxer F4A(E)37 Mot. Tecumseh (P 37)	0,70	BR4-LM	4133	05	4358
Pointer F4 .37 Mot. Tecumseh	0,70	BR4-LM	4133	05	4358
Springer K5A Mot. Kawasaki FC150	0,80	BPR6ES	7822	04	7678
Springer B5A Mot. B&S (Q50)	0,70	BR2-LM	5798	06	4740
Springer F5A,F5AE Mot. Tecumseh (S40)	0,70	BR2-LM	5798	06	4740

VAP - Tronçonneuses

530, 535, 542, 548, 553, 570	0,80	BPMR7A	4626	02	5959
------------------------------	------	--------	------	----	------

VECTRA - Tondeuses

Mot. B&S 4 / 4.75 / 5 / 5.5 / 11.5 / 13 / 15 hp	0,70	BR2-LM	5798	06	4740
Mot. B&S Twin 16.5 hp	0,70	BR2-LM	5798	06	4740
Mot. Kohler Twin 20 hp	0,60	BPR4FS	1127	-	-

VENTRAC - Tondeuses

3121 Mot. B&S Vanguard 21 hp	0,70	BKR5ES	2460	07	4803
4500K, 4500P Mot. B&S Vanguard 31 hp	0,70	BKR5ES	2460	07	4803
Mot. B&S (3 cyl. - refr.liquide) 31hp	0,90	BKR5E	7938	07	4803
Mot. Kawasaki 19 / 25 / 27 hp	0,80	BPR5ES	7422	03	6854

VICTA - Tondeuses

Tous modèles	0,70	BR2-LM	5798	06	4740
--------------	------	--------	------	----	------

VIGOR - Tondeuses

139F	0,70	C7HSA	4629	-	-
1E36F	0,80	BMR6A	7421	01	5478

VIKING - Outils Divers

VH 300 / 340 / 450 / 550B	0,60	BR2-LM	5798	06	4740
---------------------------	------	--------	------	----	------

VIKING - Tondeuses

FM 350 / 480 / 590	0,60	BR2-LM	5798	06	4740
MB 2 R / 3 R / 6 RC	0,60	BR2-LM	5798	06	4740
MB 400, 410, 415, 443 / T, 448 / T, 450 / M	0,60	BR2-LM	5798	06	4740
MB 455 / E / M / BC, 460, 465, 500	0,60	BR2-LM	5798	06	4740
MB 505 / E / S / BS / S, 555 / E / S / BS / M	0,60	BR2-LM	5798	06	4740
MB 650 T / V / VM / VQ / VS OHV, 655 KS OHV	0,90	BKR5ES	2460	07	4803
MB 750 KS & 755 KS Mot. Kawasaki FJ180V	0,70	BPR5ES	7422	03	6854
Mot. B&S Culasse Ø14 mm	0,60	B2-LM	1147	06	4740
Mot. B&S Culasse Ø18 mm	0,60	AB-6	2910	-	-
Mot. Wisconsin	0,60	AB-6	2910	-	-
MR 210, MT 410 / 640 / 680	0,70	BCPR5ES	6130	07	4803
MT 420 / 540	0,70	BR2-LM	5798	06	4740
RL455B	0,60	BR2-LM	5798	06	4740

VOGEL & NOOT - Tondeuses

Mot. Bombardier Rotax	0,50	AB-6	2910	-	-
Mot. MAG	0,50	B-4	3210	-	-

VOGT - Tondeuses

Tous modèles	0,70	BR2-LM	5798	06	4740
--------------	------	--------	------	----	------

VULCAN - Tondeuses

Mot. B&S 3.5 hp, Mot. Tecumseh 3.5 hp	0,70	BR2-LM	5798	06	4740
---------------------------------------	------	--------	------	----	------

Modèle

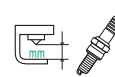
 N° STOCK BOÎTE
 N° BLISTER
 N° STOCK BLISTER

WACKER - Générateurs

G 2.5A / B - Mot. B&S 5.5 hp	0,60	B2-LM	1147	06	4740
G 2.5A / B - Mot. Honda 5.5 hp	0,70	BP5ES	6511	03	6854
G 4.5A / B - Mot. B&S 10 hp	0,60	B2-LM	1147	06	4740
G 4.5A / B - Mot. Honda 9 hp	0,70	BP5ES	6511	03	6854
GS 5.5A / B - Mot. B&S 11 hp	0,60	B2-LM	1147	06	4740
GS 5.5A / B - Mot. Honda 11 hp	0,70	BP5ES	6511	03	6854
GS 6.5A / B - Mot. Honda 13 hp	0,70	BP5ES	6511	03	6854
HGG3 / 180 / 240	0,60	B6S	3510	09	6048

WACKER - Tronçonneuses

BTS 930 L3 / 935 L3 / 1030 L3 / 1035 L3 / 1140 L3 0,50	BPMR7A	4626	02	5959
--	--------	------	----	------

WAGNERMOBILE - Manutention

MA20 / B, 25 / B, 30 / B / S, 35, 40, 45, 50, 55	0,60	AB-6	2910	-	-
MA60 / H, 70 / H, 80 / H, 90 / H, MSA20, 25, 30, 35	0,60	AB-6	2910	-	-
MA100, MA100H, MA120	0,60	AB-6	2910	-	-
MSB20, 25, 30, 35 - Culot court	0,60	BP6HS	4511	-	-
MSB20, 25, 30, 35 - Culot long	0,60	BP6ES	7811	04	7678
MY20, 25, 30, 40C	0,60	XR5	3332	-	-
MY40, 50, 60 (74-75) - Mot.Chrysler 225	0,90	BPR4ES	7222	-	-
MY40, 50, 60, 70 Mot. MM 220	0,60	AB-6	2910	-	-
MY70, 80B (76-81) - Mot.Chrysler 225	0,90	UR4	6630	-	-
MY100, 120, 140	0,60	B6ES	7310	-	-
MYA40, 50, 60, 70	0,60	AB-6	2910	-	-
MYC160/H, 180/H, 200/H, 220H, 240, 260, 300	0,60	BP5ES	6511	03	6854
Tous modèles	0,60	B6S	3510	09	6048
WC20, 25, 30/S, 35, 45, 50, 55, 60	0,60	AB-6	2910	-	-

WALKER - Tondeuses

MB Mot. B&S Vanguard 18 hp	0,70	BKR5ES	2460	07	4803
MC Mot. Kohler 16 hp	0,60	BKR5ES	2460	07	4803
MC Mot. Kohler CH18 18 hp	0,70	BKR5ES	2460	07	4803
MC Mot. Kohler M16 16 hp	0,60	BM6A	5921	01	5478
MDG - Mot. Kubota WG750-B 24 hp	1,10	BCPR6ES-11	7121	-	-
Mot. B&S 11 hp	0,70	BR2-LM	5798	06	4740
Mot. Kawasaki OHV 11 / 11.5 / 13 hp	0,80	BPR5ES	7422	03	6854
Mot. Kawasaki OHV V-Twin FH430V 15 hp	0,70	BPMR6A	6726	08	5063
Mot. Kohler 16 hp	0,70	B-6L	3212	-	-
Mot. Kohler Twin 16 hp	0,60	BPR4FS	1127	-	-
Mot. Kohler V-Twin 16 / 18 / 20 / 25 / 26 hp	0,90	BKR5E	7938	07	4803
Mot. Kubota WG600-B 21 hp	0,90	BKR5E	7938	07	4803
Mot. Kubota WG750-B 24.5 hp	0,80	BCPR5ES	6130	07	4803
MS - Mot. Kawasaki FE350D 11.5 hp	0,70	BPR5ES	7422	03	6854
MS / S - Mot. Kawasaki FE400 13 hp	0,70	BPR5ES	7422	03	6854
MT20 / T - Mot. Kohler CH20 20 hp	0,70	BKR5ES	2460	07	4803
MT25 - Mot. Kohler 25 hp	0,70	BKR5ES	2460	07	4803
MT26 - Mot. Kohler CH26 26 hp	0,70	BKR5ES	2460	07	4803
MTL25 - Mot. Kohler LH25 25 hp	0,70	BKR5ES	2460	07	4803
MTL31 - Mot. Kohler LH775 31 hp	0,70	BKR5ES	2460	07	4803
MW - Mot. Kawa. OHV V-Twin FH430V 15hp	0,90	BCPR6ES	2330	-	-
S Mot. Kawasaki FE400 13 hp	0,70	BPR5ES	7422	03	6854
T Mot. Kohler CH20 20 hp	0,70	BKR5ES	2460	07	4803
W Mot. Kawasaki FH430V 15 hp	0,90	BCPR6ES	2330	-	-

WARD LAKESIDE - Tondeuses

Tous modèles	0,70	BR2-LM	5798	06	4740
--------------	------	--------	------	----	------

WARDS - Tondeuses

Mot. B&S	0,80	B2-LM	1147	06	4740
----------	------	-------	------	----	------

WARDS - Tronçonneuses

24148	0,80	BR6S	3522	09	6048
24000A, 24001A, 24002A, 24002B/C, 24003A	0,70	BM7A	6521	10	6793
24005A/B, 24006A/B, 24007A/B, 24008A/B	0,70	BM7A	6521	10	6793
24025A/B, 24027A, 24028A, 24030A, 24031A	0,70	BM7A	6521	10	6793
24032A, 24033A, 24034A, 24035A, 24036A/B/C/D	0,70	BM7A	6521	10	6793
24037A, 24038A, 24040A/B/C, 24045A	0,70	BM7A	6521	10	6793
24050A, 24052A, 24054A	0,80	BPMR7A	4626	02	5959
24056A, 24062, 24064, 24066, 24068	0,80	BPMR7A	4626	02	5959
24060A	0,80	BR6S	3522	09	6048
24072A, 24075A, 24075B, 24075C	0,70	BM7A	6521	10	6793

Modèle

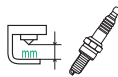

N° STOCK BOÎTE
N° BLISTER
N° STOCK BLISTER

24078, 24084, 24086	0,80	BPMR7A	4626	02	5959
24085A, 24087A, 24089A, 24090A	0,70	BM7A	6521	10	6793
24094A, 24095A, 24096A	0,70	BM7A	6521	10	6793
24100-1, 24102-9, 24103-6	0,60	BMR6A	7421	01	5478
30000A, 30004A, 30008A	0,70	BM7A	6521	10	6793
30012A, 30016A, 30020A, 30024A	0,70	BM7A	6521	10	6793
TMC 24060A	0,80	B6S	3510	09	6048
TMC 24072A, TMC 24075A / B	0,70	BM7A	6521	10	6793
TMC 24085A, TMC 24095A	0,70	BM7A	6521	10	6793

WARE - Tondeuses

Mot. B&S V-Twin Vanguard 16 hp	0,90	BKR5E	7938	07	4803
--------------------------------	------	-------	------	----	------

WAUKESHA - Générateurs

6 BZ / GAK / GAL / MZA / MZR	0,60	B6S	3510	09	6048
6 SRKR / SRLR / WAK / WAL	0,60	B6S	3510	09	6048
135 G / GK / GKB / GZ / GZB	0,60	B-6L	3212	-	-
140 G / GK / GKB / GZ / GZB	0,60	B-6L	3212	-	-
145 G / GK / GKB / GZ / GZB	0,60	B-6L	3212	-	-
F265GA, F283G, VRG265, VRG283	0,60	BP5ES	6511	03	6854
F544G, F817G, FC, ICK	0,60	B6S	3510	09	6048
H540, H570, H844, H884, H884G	0,60	B6S	3510	09	6048
Tous modèles - Ø 18 mm	0,60	AB-6	2910	-	-
VRG220, VRG230, VRG310	0,60	BP5ES	6511	03	6854

WEED EATER - Tondeuses

1000	0,60	B7HS	5110	-	-
Mot. B&S 4 / 4.25 / 5 / 5.25 / 5.5 / 6 hp	0,70	BR2-LM	5798	06	4740
Mot. Fuji-Robin	0,80	BM7A	6521	10	6793
Mot. Kioritz	0,80	BMR6A	7421	01	5478
Mot. Tecumseh	0,70	BR6S	3522	09	6048
WE 1642, WE 12538 - Mot. B&S 12.5 hp	0,70	BR2-LM	5798	06	4740
WE 14542	0,90	BKR5E	7938	07	4803
WE 18542 / 185H42	0,70	BR2-LM	5798	06	4740

WEST BEND - Tronçonneuses

Tous modèles	0,60	BMR6A	7421	01	5478
--------------	------	-------	------	----	------

WHEEL HORSE - Tondeuses

Mot. B&S 3.5 hp	0,70	BR2-LM	5798	06	4740
Mot. Kawasaki 12.5 hp	0,60	BM4A	5628	-	-
Mot. Kohler K181 8 hp	0,70	BR6S	3522	09	6048
Mot. Kohler K241 10hp / K301 12hp / K321 14hp	0,60	B-6L	3212	-	-
Mot. Kohler K341 16hp / K532 20hp	0,60	B-6L	3212	-	-
Mot. Kohler KT17 17hp, Mot. Kohler Twin 17hp	0,60	UR4	6630	-	-
Mot. Renault	0,70	BP6HS	4511	-	-
Mot. Tecumseh	0,60	BR6S	3522	09	6048

WHEELBURRO - Tondeuses

Mot. B&S 5 hp	0,70	BR2-LM	5798	06	4740
---------------	------	--------	------	----	------

WHEELER - Tondeuses

Mot. B&S 3.5 / 3.75 / 4 / 5 hp	0,70	BR2-LM	5798	06	4740
Mot. Tecumseh 5 hp	0,70	BR6S	3522	09	6048

WHIRL-CUT - Tondeuses

Tous modèles	0,70	BR2-LM	5798	06	4740
--------------	------	--------	------	----	------

WHIRLER-GLIDE - Tondeuses

Tous modèles	0,70	BR2-LM	5798	06	4740
--------------	------	--------	------	----	------

WHITE MOTOR - Tronçonneuses

010 / 020 / 014	0,80	BM6A	5921	01	5478
WM19 / WM21 / WM360	0,60	BMR6A	7421	01	5478

WHITE - Tondeuses

Mot. B&S 3.75 / 4.5 / 5 / 5.5 / 6 hp	0,70	BR2-LM	5798	06	4740
Mot. B&S 6.5 / 6.75 hp	0,70	BKR5ES	2460	07	4803
Mot. B&S Intek 17 hp, B&S Intek V-Twin 22 hp	0,70	BKR5ES	2460	07	4803

Modèle

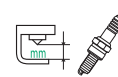

N° STOCK BOÎTE
N° BLISTER
N° STOCK BLISTER

WHITEHEAD - Tronçonneuses

86008	0,70	B5HS	4210	-	-
-------	------	------	------	---	---

WHITEMAN - Manutention

Power Buggy - Mot. Robin EY27	0,60	B6HS	4510	-	-
Power Buggy - Ø14mm	0,60	BR6S	3522	09	6048
Power Buggy - Ø18mm	0,60	AB-6	2910	-	-

WHIZ-MOW - Tondeuses

Tous modèles	0,70	B-6L	3212	-	-
--------------	------	------	------	---	---

WIGGINS - Manutention

Tous modèles - Mot. Ford 300 ci.	0,80	WR5	2438	-	-
----------------------------------	------	-----	------	---	---

WIKOV - Tondeuses

Mot. B&S 12 / 12.5 / 15.5 hp	0,70	BR2-LM	5798	06	4740
Mot. B&S Vang. V-Twin 15 / 16 / 18 / 20 hp	0,90	BKR5E	7938	07	4803
Mot. Honda OHV 13 hp	0,80	BPR5ES	7422	03	6854
Mot. Honda OHV V-Twin 20 hp	0,80	BPR5ES	7422	03	6854
Mot. Kohler OHV V-Twin 18 hp	0,90	BKR5E	7938	07	4803

WILKRA - Manutention

Tous modèles	0,60	B6S	3510	09	6048
--------------	------	-----	------	----	------

WISCONSIN - Générateurs

03, 04, AC4, EY21W	0,60	B6S	3510	09	6048
AC4S	0,60	B-6L	3212	-	-
Autres modèles (Essence)	0,70	AB-6	2910	-	-
Autres modèles (GPL)	0,50	AB-7	3010	-	-
EY13 / 18 / 25 / 33 / 44	0,60	BP-4H	3311	-	-
EY14W / 18W / 18-3W / 25W / 27W / 44W	0,60	B6HS	4510	-	-
V460D, V461D, V465d (non blindé)	0,70	BP5ES	6511	03	6854

WIZARD (WEST. AUTO) - Tondeuses

Mot. Clinton 2 tps	0,70	B-6L	3212	-	-
Mot. Clinton 4 tps	0,80	BMR6A	7421	01	5478
Mot. Power Pak	0,70	BR6S	3522	09	6048
Mot. Power Products	0,80	BMR6A	7421	01	5478
Propulsion VE901R	0,90	B-4	3210	-	-

WIZARD - Tronçonneuses

010 / 011 / 012 / 014, 104 / D, 110, 112, 212	0,60	BMR6A	7421	01	5478
314, 316, 420, 430 / B, AV10 / 14 / 16	0,60	BMR6A	7421	01	5478
AV18 / B013	0,70	BPMR6A	6726	08	5063

WOLF GARTEN - Tondeuses

Mot. Tecumseh OHV 6 hp	0,80	BR7ES	5122	-	-
------------------------	------	-------	------	---	---

WOLF - Tondeuses

Cart OHC 2	0,80	BPR5ES	7422	03	6854
Cart SV3	0,60	BR2-LM	5798	06	4740
Concept 43BPP / 43BA / 43BAI / 47BA / 47BAM	0,60	BR2-LM	5798	06	4740
Esprit 40-B / 40-BA / 46-B / 46-BA	0,60	BR7ES	5122	-	-
Mot. Aspera, Mot. B&S	0,60	B4-LM	3410	05	4358
Mot. F&S Ø14 mm	0,60	B6HS	4510	-	-
Mot. F&S Ø18 mm	0,50	AB-6	2910	-	-
Mot. Hirth Ø14 mm	0,60	B6HS	4510	-	-
Mot. Hirth Ø18 mm	0,50	AB-7	3010	-	-
Mot. Sachs	0,50	B6HS	4510	-	-
PC-FL / FEL	0,70	BMR6A	7421	01	5478
PG 47 SL	0,60	AB-6	2910	-	-
Power Edition 40-B / BA, 42QR / QRA, 46BA	0,70	BR2-LM	5798	06	4740
Power Edition 48QR / QRA / QRA-HW, 53QRA	0,70	BR2-LM	5798	06	4740
Pro 46 / 51 / 61	0,50	BP-4	2911	-	-
Pro 80 - Mot. Kawasaki FH430V	0,70	BPMR6A	6726	08	5063
Scooter OHV3	0,60	BR7ES	5122	-	-
Scooter SV4	0,60	BR2-LM	5798	06	4740
TA 40 CA / S / SI, TA 42 SB / SI / SM	0,70	BMR6A	7421	01	5478
TA 40 CF / SF, TA 42 SF	0,60	BP-4	2911	-	-

Modèle

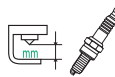
 N° STOCK BLISTER
 N° BOÎTE
 N° BLISTER

WOLF - Tondeuses				
TA 46 MB / TA 52 WB	0,70	BM6A	5921	01 5478
TA 52 CB / CT / SI / SM / ST	0,70	BMR6A	7421	01 5478
TA 52 SF	0,50	BP-4	2911	- -
TA 52 SK	0,60	BPR6ES	7822	04 7678
TA 52 SO	0,60	BR6ES	4922	- -
TA 52 WS	0,50	B5HS	4210	- -
TA 70 S / TA 70 SI	0,70	BMR6A	7421	01 5478
TA 70 SF	0,50	BP-4	2911	- -
TB 40 CBK / CL / CN / S	0,70	BMR6A	7421	01 5478
TB 40 CFK / CS / SF	0,60	BP-4	2911	- -
TB 42 CB / CT / SI / SM / ST	0,70	BMR6A	7421	01 5478
TB 42 CF / SF	0,60	BP-4	2911	- -
TB 46 MB	0,70	BM6A	5921	01 5478
TB 46 MI / RA / RB / RBL / RF	0,70	BMR6A	7421	01 5478
TB 46 VF	0,50	BP-4	2911	- -
TB 50 S, TB 52 CB / CT, TB 70 S	0,70	BMR6A	7421	01 5478
TB 50 SF / TB 52 SF / TB 70 SF	0,60	BP-4	2911	- -
TD 38 L / TD 46 L	0,70	BMR6A	7421	01 5478
TG 38 SLE / TG 47 SLE	0,60	AB-6	2910	- -
TI 38 / L, TI 46 C / L	0,70	BMR6A	7421	01 5478
TL 47 / TR 46	0,60	BMR6A	7421	01 5478
Trac OHV 6 / OHV 7	0,80	BPR5ES	7422	03 6854
TR-SL	0,70	BMR6A	7421	01 5478

WOOD BOSS - Tronçonneuses

Tous modèles	0,80	B6S	3510	09 6048
--------------	------	-----	------	---------

WOOD WACKER - Tronçonneuses

Mot. B&S	0,70	BR2-LM	5798	06 4740
----------	------	--------	------	---------

WOODWARDS - Tondeuses

Mot. B&S	0,70	BR2-LM	5798	06 4740
----------	------	--------	------	---------

WORCHESTER - Tondeuses

Mot. B&S	0,70	BR2-LM	5798	06 4740
Mot. Clinton 2 tps	0,80	BP5S	3011	- -
Mot. Clinton 4 tps, Mot. Lauson	0,70	BR6S	3522	09 6048

WORTHINGTON - Manutention

Tous modèles	0,60	AB-6	2910	- -
--------------	------	------	------	-----

WORTHINGTON - Tondeuses

Tous modèles	0,60	AB-6	2910	- -
--------------	------	------	------	-----

WRIGHT STANDER - Tondeuses

Mot. B&S Vanguard V-Twin 16 / 18 / 20 hp	0,80	BKR5E	7938	07 4803
Mot. Kawasaki OHV 15 / 17 / 19 / 23 hp	0,80	BPR5ES	7422	03 6854
Mot. Kohler (Refr. Liquide) V-Twin 23 hp	0,80	BKR5E	7938	07 4803
Mot. Kohler V-Twin 20 / 22 hp	0,80	BKR5E	7938	07 4803

WRIGHT - Tondeuses

Sentar WSES3618 Kawa. OHV 585cc 17hp	0,70	BPMR6A	6726	08 5063
Sport 3618,5 Mot. Kawasaki FS600 OHV	0,80	BPR4ES	7222	- -
Sport 4819 Mot. Kawasaki FX600 OHV 19hp	0,80	BPR4ES	7222	- -
Sport X 4822 Mot. Kawasaki FX691 OHV 22ch	0,80	BPR4ES	7222	- -
Stander WSR3617 - 17HP/36 Kawa. 17hp	0,80	BPR5ES	7422	03 6854
Stander WSR4217 - 17HP/42 Kawa. 17hp	0,80	BPR5ES	7422	03 6854
Velke 3215 Mot. Kawasaki FS541 OHV	0,80	BPR4ES	7222	- -
Velke 3615 Mot. Kawasaki FS541 OHV	0,80	BPR4ES	7222	- -
Velke 3618,5 DE Mot. Kawasaki FS600 OHV	0,80	BPR4ES	7222	- -
Velke 4818,5 DE Mot. Kawasaki FS600 OHV	0,80	BPR4ES	7222	- -
Velke WV3615PG 36 Kawa. OHV 431cc 15hp	0,70	BPMR6A	6726	08 5063
Velke WV4817PG 48 Kawa. OHV 585cc 17hp	0,70	BPMR6A	6726	08 5063
Velke WV4818PG 48 Kawa. OHV 585cc 18hp	0,70	BMR6A	7421	01 5478
Z 48-25,5 Mot. Kawasaki FX801E OHV 25,5	0,80	BPR4ES	7222	- -
Z 48-27 Mot. Kawasaki FX850 27 hp	0,80	BPR4ES	7222	- -
Z 52-25,5 Mot. Kawasaki FX801E OHV 25,5	0,80	BPR4ES	7222	- -
Z 52-27 & Z 61-27 Mot. Kawasaki FX850 27 hp	0,80	BPR4ES	7222	- -

Modèle

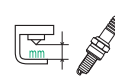
 N° STOCK BLISTER
 N° BOÎTE
 N° BLISTER

WRIGHT - Tronçonneuses				
104 / D, 111, 121, 122A/CVA, 136, 137A, 140, 141A	0,60	BMR6A	7421	01 5478
1441A	0,60	BM6A	5921	01 5478
C40 / 40D	0,80	BR6S	3522	09 6048
C70 / 70D / 70G	0,80	B6S	3510	09 6048
GS218 / GS2520	0,70	B-4	3210	- -

XENOAH - Tronçonneuses

G36AV, G36AVS, G50AV	0,70	BPM6A	7021	08 5063
G320AV / AVS, G380AV / AVS	0,70	BPMR6A	6726	08 5063
G400, G560AV / AVS, G561, G620AV / AVS, G621	0,70	BPM6A	7021	08 5063

XPIDITER - Manutention

Tous modèles	0,70	AB-6	2910	- -
--------------	------	------	------	-----

YALE - Manutention

Continental F124 / 162 / 163	0,60	AB-6	2910	- -
G10P, G54P	0,60	BR6S	3522	09 6048
G51C, G54C, 52 Series	0,60	AB-6	2910	- -
G83 Chrysler Mot. H225 (->E252034)	0,60	BP5ES	6511	03 6854
G83 Chrysler Mot. H225 (E252035->)	0,60	UR4	6630	- -
KG51, KGP51	0,60	BR6S	3522	09 6048
I.H.C. UC1235B	0,60	AB-6	2910	- -
I.H.C. V345	0,60	B6S	3510	09 6048
LeRoi Mot. D-471-Gaz Naturel	0,40	AB-6	2910	- -
Lift King - Mot.Chrysler IND31	0,60	BR6S	3522	09 6048
Lift King Mot. I.H.C.	0,60	AB-6	2910	- -
Mot. Chrysler H318	0,60	XR5	3332	- -
Mot. Chrysler IND31	0,60	BR6S	3522	09 6048
Mot. Ford K292	0,60	WR5	2438	- -
Mot. Mazda 121 ci.	0,70	BPR4ES	7222	- -
Y-18	0,60	BR6S	3522	09 6048
Yard King	0,60	B6S	3510	09 6048

YAMAHA - Générateurs

3 TG 66 / 72	0,80	BPR4ES	7222	- -
E 1200	0,70	BPR6HS	7022	- -
EC 2000, 2800, 4000DV, 5000DV / DVE / E	0,60	BPR6HS	7022	- -
EF 600 S, EF 800, EF 900 / S	0,70	BPR6HS	7022	- -
EF 1000 - Mot. 1 Cyl. 2 soupapes (Refr. Air) 84cc	0,70	BPR6HS	7022	- -
EF 1000 A - Mot. 1 Cyl. 2 soupapes (Refr. Air) 84cc	0,70	BPR6HS	7022	- -
EF 1000 B	0,70	BPR6HS	7022	- -
EF 1000 IS	0,60	CR4HSB	4695	- -
EF 1200 (-84)	0,60	BP6HS	4511	- -
EF 1200 (85-), EF 1200 A / DA / DV	0,60	BPR6HS	7022	- -
EF 1200 DE 2 Cyl. 2 soupapes (Refr. Air) 653 cc	0,80	BPR6ES	7822	04 7678
EF 1400 / DV (-84)	0,60	BP6HS	4511	- -
EF 1400 / DV (85-)	0,60	BPR6HS	7022	- -
EF 1400 H	0,60	BP6HS	4511	- -
EF 1400 HK (-85), EF 1400 K (-84)	0,60	BP4HS	3611	- -
EF 1400 K (85-)	0,60	BPR4HS	7823	- -
EF 1500 S	0,70	B7HS	5110	- -
EF 1600 (-95)	0,70	BPR6HS	7022	- -
EF 1600 (96-) 1 Cyl. 2 Soupapes (Refr. Air) 123cc	0,70	BPR4ES	7222	- -
EF 1600 A / X	0,70	BPR4ES	7222	- -
EF 1600 R, EF 1700 / A / DV	0,70	BPR6HS	7022	- -
EF 1800	0,70	BP6HS	4511	- -
EF 200 A / 200 DV	0,70	BPR6HS	7022	- -
EF 2000 / DV (-84)	0,70	BP6HS	4511	- -
EF 2000 / DV (85-), EF 2000 A	0,70	BPR6HS	7022	- -
EF 2000 H	0,70	BP6HS	4511	- -
EF 2000 HK (-85)	0,60	BP4HS	3611	- -
EF 2000 IS / ISH	0,70	BPR6HS	7022	- -
EF 2000 K (-84)	0,70	BP4HS	3611	- -
EF 2000 K (85-)	0,70	BPR4HS	7823	- -
EF 2008 I	0,70	BPR4ES	7222	- -
EF 2100	0,70	BPR6HS	7022	- -
EF 2300 / A / S / SE / X	0,70	BPR4ES	7222	- -
EF 2400 (-84)	0,70	BP6HS	4511	- -
EF 2400 (85-), EF 2400 A / DV	0,70	BPR6HS	7022	- -
EF 2400 ISHC	0,80	BPR4ES	7222	- -
EF 2500 / R	0,70	BPR6HS	7022	- -
EF 2600 (-95)	0,70	BP6HS	4511	- -
EF 2600 / A (96->) 1 cyl 2 val. REF Air 171cc	0,70	BPR4ES	7222	- -

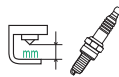

EF 2800 / DV (-84)	0,70	BP6HS	4511	-	-
EF 2800 / A / DV (85-)	0,70	BPR6HS	7022	-	-
EF 2800 H	0,70	BP6HS	4511	-	-
EF 2800 HK	0,70	BP4HS	3611	-	-
EF 2800 I	0,60	BPR4ES	7222	-	-
EF 2800 K (-84)	0,70	BP4HS	3611	-	-
EF 2800 K (85-)	0,70	BPR4HS	7823	-	-
EF 3000 / I / ISE / ISEB	0,70	BPR4ES	7222	-	-
EF 3200 / E / R, EF 3600 / DV / DVE / E	0,70	BPR6HS	7022	-	-
EF 3800 / E / R, EF 4000	0,70	BPR6HS	7022	-	-
EF 4000 A / DE / DEX	0,70	BPR4ES	7222	-	-
EF 4000 DV	0,70	BPR6HS	7022	-	-
EF 4000 DVE	0,70	BP6HS	4511	-	-
EF 4000 E	0,70	BPR6HS	7022	-	-
EF 4000 EX	0,70	BPR4ES	7222	-	-
EF 4000 K	0,70	BPR4HS	7823	-	-
EF 4000 X	0,70	BPR4ES	7222	-	-
EF 4300, EF 4400 / DV / DVE / E	0,70	BPR6HS	7022	-	-
EF 4500 ISE	0,80	BPR4ES	7222	-	-
EF 4600 A / DE - 1 cyl 2 valves REF air 301cc	0,70	BPR4ES	7222	-	-
EF 5000 DV / DVE	0,70	BPR6HS	7022	-	-
EF 5000 EA, EF 5200 DE	0,70	BPR4ES	7222	-	-
EF 5400 / E	0,70	BPR5ES	7422	03	6854
EF 5500 A / EX / X	0,70	BPR4ES	7222	-	-
EF 6000	0,70	BPR5ES	7422	03	6854
EF 6000 DVE / E / EA / TE	0,70	BPR4ES	7222	-	-
EF 6300 ISDE	0,80	BPR4ES	7222	-	-
EF 6600 A/DE - 1 cyl 2 Soupapes (Refr. Air) 357cc	0,70	BPR4ES	7222	-	-
EFC 1400 / 2000 / 2600 / 2800	0,70	BP6HS	4511	-	-
EFW 150 S	0,70	BPR6HS	7022	-	-
ET 1500 (-80)	0,70	B6HS	4510	-	-
ET 1500 (81-), ET 1500 D / M / S	0,70	B7HS	5110	-	-
ET 300	0,70	BP5HS	4111	-	-
ET 350, ET 500	0,70	B5ES	6410	-	-
ET 600	0,70	BR5ES	4722	-	-
ET 600 A, ET 650	0,70	B5ES	6410	-	-
ET 800	0,70	BR5ES	4722	-	-
ET 900 / A, ET 950	0,70	B5ES	6410	-	-
ETS 600 / A, ETS 900 / A	0,70	B5ES	6410	-	-
GA 90 / 120 / 140 / 160 / 180	0,90	BPR5ES	7422	03	6854
GA 210 / 220 / 240 / 280 / 300	0,90	BPR5ES	7422	03	6854
GE 20	0,70	BPMR4A	6028	-	-
GE 25S / 36S / 50S / 90S	0,70	B-4H	4110	-	-
GE 50 / 55 / 70 / 77 / 90	0,70	BPR4HS	7823	-	-
GY 15 / 20	0,70	BPMR4A	6028	-	-
GY 35	0,70	BPR4HS	7823	-	-
GY 35 (V) / 50 (V)	0,70	BR4HS	3322	-	-
MA 110MA-R	0,60	B-4H	4110	-	-
MF 150 A / 150S, MF 180 A / AR / S / SR	0,60	BP6HS	4511	-	-
MF 180 K / AK / SK	0,60	BP4HS	3611	-	-
MF 260 A / AR / S / SR	0,60	BP6HS	4511	-	-
MF 260 K / AK / SK	0,60	BP4HS	3611	-	-
MF 410 / S / SR	0,60	BP6HS	4511	-	-
MF 410 SK	0,60	BP4HS	3611	-	-
MFS 260	0,60	BP6HS	4511	-	-
MFS 260 K	0,60	BP4HS	3611	-	-
Midori YRT 335	0,70	BR4ES	1097	-	-
Midori YRT 550	0,70	BPR5ES	7422	03	6854
MT 110 A / AR	0,60	B7HS	5110	-	-
MT 110 MB / MB-R	0,60	B-4H	4110	-	-
MT 110 VL	0,60	B7HS	5110	-	-
MZ 125 / R	0,70	BPR4ES	7222	-	-
YBC 20 D / 20 S / 30 D / 40 D / 50 D	0,60	BPMR6A	6726	08	5063
YG 300 S, YG 400 D, YG 450 D	0,70	BPR6HS	7022	-	-
YG 500 D	0,80	BPR5ES	7422	03	6854
YG 550 D	0,70	BPR4ES	7222	-	-
YG 600 D / DE	0,80	BPR5ES	7422	03	6854
YG 650 D / DE / DV / DVE	0,70	BPR4ES	7222	-	-
YG 2600 1 Cyl. 2 soupapes (Refr. Air) 171 cc	0,70	BPR4ES	7222	-	-
YG 2800 I, YG 4000 D	0,70	BPR4ES	7222	-	-
YG 4600 D 1 Cyl. 2 soupapes (Refr. Air) 301 cc	0,70	BPR4ES	7222	-	-
YG 5200 D, YG 6500	0,70	BPR4ES	7222	-	-
YG 6600 D/DE 1 Cyl. 2 soupapes (Refr. Air) 357 cc	0,70	BPR4ES	7222	-	-
YP 2	0,60	B7HS	5110	-	-
YP 3	0,60	BP6HS	4511	-	-
YP 10 / G / GN	0,70	BR7HS	4122	-	-
YP 15 H	0,60	BP6HS	4511	-	-

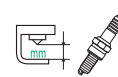

YP 20	1,00	BP4HS	3611	-	-
YP 20 G	0,60	B7HS	5110	-	-
YP 20 G (N)	1,00	BP4HS-10	5011	-	-
YP 20 GA	0,70	BPR6HS	7022	-	-
YP 20 GN	1,00	BP4HS	3611	-	-
YP 20 GX	0,70	BPR4ES	7222	-	-
YP 20 H / M / MH / NT / S / T	0,60	BP6HS	4511	-	-
YP 20 TA	0,70	BPR6HS	7022	-	-
YP 20 Z	0,60	BP6HS	4511	-	-
YP 30	0,60	BP5ES	6511	03	6854
YP 30 E	0,60	BP4HS	3611	-	-
YP 30 G	0,60	BP6HS	4511	-	-
YP 30 GA	0,70	BPR6HS	7022	-	-
YP 30 GK	0,60	BP4HS	3611	-	-
YP 30 GN (-87)	0,70	BP6HS	4511	-	-
YP 30 GN (88-90)	0,80	BP5ES	6511	03	6854
YP 30 GX	0,70	BPR4ES	7222	-	-
YP 30 MH / NT / S / T	0,60	BP6HS	4511	-	-
YP 30 TA, YP 40 TA	0,70	BPR6HS	7022	-	-
YRT 335	0,70	BR4ES	1097	-	-
YSG 550E / 750A / 750AE / 750E	0,70	BPMR4A	6028	-	-
YSG 1505 / 1506 / 2005 / 2006 / 2505 / 2506	0,90	BPR5ES	7422	03	6854
YSG 3005 / 3006 / 3505 / 3506	0,90	BPR5ES	7422	03	6854

YAMAHA - Outils Divers

YS 624 / 828	0,80	BPR4HS	7823	-	-
YSDX	0,80	BPR4ES	7222	-	-

YAMAHA - Tondeuses

Midori YMM 135	0,70	BR4ES	1097	-	-
MK 410 SK	0,60	BP4HS	3611	-	-
MT 110 A / AR / VL	0,60	B7HS	5110	-	-
YBC 20S / D, 30D, 40D, 50D	0,70	BPMR6A	6726	08	5063
YLM 342 / P / S / SE / PR / SR / SER	0,80	BR4ES	1097	-	-
YLM 346 / P / S / SE / SR / SER	0,70	BR4ES	1097	-	-
YLM 446, 453, 553 / P / S / SB / SE / SBE	0,80	BPR5ES	7422	03	6854
YLM 466 OHV	0,80	BPR5ES	7422	03	6854
YLM 653 S / SB	0,70	BPR5ES	7422	03	6854
YLM 3600, YLM 653	0,80	BPR5ES	7422	03	6854
YMS 204	0,80	B2-LM	1147	06	4740
YT 2300	1,00	BCPR5ES	6130	07	4803
YT 3600 / N	0,80	BPR4ES	7222	-	-
YT 3600 M	0,80	BR4ES	1097	-	-
YT 6800 N	0,80	BPR5HS	6222	-	-

YAMATSU - Outils Divers

FL 251	0,70	BM7A	6521	10	6793
SA 706 M1 Mot. 181cc	0,80	BPR5ES	7422	03	6854
SA 706 MX1	0,70	BP6HS	4511	-	-
SA 708 MX Mot. 296cc, SG 810 MT Mot. 296cc	0,80	BP5ES	6511	03	6854
SH 913 ML2-S Mot. 391cc	0,90	BCPR5ES	6130	07	4803
SH 913 MRA2e Mot. GM 401 OHV 391cc	0,90	BCPR5ES	6130	07	4803
SI 1022 P Mot. Subaru 653cc	0,80	BPR2ES	2264	-	-
SK 708 M Mot. 296cc, SK 810 M Mot. 296cc	0,80	BP5ES	6511	03	6854

YAMATSU - Tronçonneuses

BP 2501H, HT250A, HT 751	0,70	BM7A	6521	10	6793
THM60	0,70	BPMR6A	6726	08	5063
THP 25LK - TJ27E Mot. Kawasaki 26,3cc	0,70	BPMR7A	4626	02	5959
THY 60 - TJ23V Mot. Kawasaki 22,5cc	0,70	BPMR8Y	2218	-	-
THY 75 Mot. Kawasaki 22,5cc	0,70	BPMR6A	6726	08	5063
THY 250 A/LA Mot. Robin 24,5cc	0,70	BMR6A	7421	01	5478
THY 751 Mot. Robin 24,5cc	0,70	BMR6A	7421	01	5478

YANKEE CLIPPER - Tronçonneuses

110125	0,80	BR6S	3522	09	6048
1-36 MKI	0,70	BM7A	6521	10	6793
1-36 MKII	0,80	BMR6F	2144	11	7683
1-71-SS, 2-36-SS, 55 LH / RH, 76	0,70	BM7A	6521	10	6793

YANMAR - Outils Divers

TE 30 DX - Mot. GA90	0,90	BPR5ES	7422	03	6854
TE 500 - Mot. GA140, TE 600 - Mot. GA160	0,90	BPR5ES	7422	03	6854

Modèle

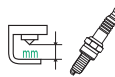
 N° STOCK BOÎTE
 N° BLISTER
 N° STOCK BLISTER

YANMAR - Outils Divers

YHB 26	0,50	BPM7A	7321	02	5959
YK 462 - Mot. GA140	0,90	BPR5ES	7422	03	6854
YK 682 - Mot. GA160, YK 782 - Mot. GA180	0,90	BPR5ES	7422	03	6854

YANMAR - Tondeuses

YL48 (GY35V) / YL53 (GE53)	0,70	BR4HS	3322	-	-
YL 480TS / TSE, YL 530TS / TSE, YL 630TS	0,50	BR2-LM	5798	06	4740

YARD MACHINE - Tondeuses

11A-020L700 & 11A-A00M700 Mot. B&S 148cc	0,70	BKR5ES	2460	07	4803
11A-A56R729 & 11A-B06R700 Mot. B&S 140cc	0,50	BKR5ES	2460	07	4803
11A-B13M729 Mot. B&S 140cc	0,50	BKR5ES	2460	07	4803
11A-B96N729 Mot. B&S 190cc	0,70	BKR5ES	2460	07	4803
12A-A03M700 & 12A-A13K729 Mot. B&S 140cc	0,50	BKR5ES	2460	07	4803
13AC762F000 12.5 Single Mot. B&S OHV	0,70	BKR5ES	2460	07	4803
13AM772S000 14.5 Single Mot. B&S OHV	0,70	BKR5ES	2460	07	4803
13AN775S000 Mot. B&S OHV 16.5 hp	0,70	BKR5ES	2460	07	4803
13AN775S200 Mot. B&S OHV 16.5 hp	0,70	BKR5ES	2460	07	4803
Mot. B&S / Tecumseh	0,70	BR2-LM	5798	06	4740

YARD PRO - Tondeuses

Mot. B&S 5 / 5.5 / 6 hp	0,70	BR2-LM	5798	06	4740
-------------------------	------	--------	------	----	------

YARD-MAN - Tondeuses

11A-A19Q701 Carb Compl. Honda OHC 160cc	0,80	BPR5ES	7422	03	6854
11A-B29Q701 Carb Compl. Honda OHC 160cc	0,80	BPR5ES	7422	03	6854
12A-B29Q701 Carb Compl. Honda OHC 160cc	0,80	BPR5ES	7422	03	6854
12AVD39Q701 Carb Compl Honda OHC 160cc	0,80	BPR5ES	7422	03	6854
17AC2ACS055 RZT Mot. B&S Intek 21 hp	0,70	BKR5ES	2460	07	4803
Mot. B&S 5 / 6 hp	0,50	BR2-LM	5798	06	4740
Mot. B&S Intek OHV 6.5hp, Mot. B&S Intek 18.5hp	0,50	BR2-LM	5798	06	4740
Mot. B&S Intek V-Twin 22 / 25 hp	0,70	BKR5ES	2460	07	4803
Mot. B&S Quantum 6.75 hp	0,70	BKR5ES	2460	07	4803
Mot. Honda 5.5 hp	0,70	BPR6ES	7822	04	7678
Mot. Kohler CH18 18 hp	0,70	BKR5ES	2460	07	4803
Mot. Tecumseh	0,60	B6S	3510	09	6048

YARDSMITH - Tondeuses

Tous modèles	0,70	BR2-LM	5798	06	4740
--------------	------	--------	------	----	------

YARDSTER - Manutention

Tous modèles	0,60	AR6FS	3323	-	-
--------------	------	-------	------	---	---

YARDSTER - Tondeuses

Tous modèles	0,70	BR2-LM	5798	06	4740
--------------	------	--------	------	----	------

YARK BRONC - Tondeuses

Mot. B&S	0,80	B2-LM	1147	06	4740
Mot. Tecumseh	0,80	B6S	3510	09	6048

Modèle

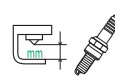
 N° STOCK BOÎTE
 N° BLISTER
 N° STOCK BLISTER

YAZOO/KEES - Tondeuses

Mot. B&S 5 / 5.5 / 6 / 8.5 / 9 hp	0,70	BR2-LM	5798	06	4740
Mot. B&S Intek OHV 6 hp	0,80	BKR5ES	2460	07	4803
Mot. Kawasaki 12.5 hp	0,60	BM4A	5628	-	-
Mot. Kawasaki OHV 14 hp	0,80	BPR5ES	7422	03	6854
Mot. Robin EY 18W / 3W	0,70	BR6HS	3922	-	-
Mot. Wisconsin EY18W	0,70	B6HS	4510	-	-
Mot. Wisconsin TJD	0,60	AB-6	2910	-	-

YETTER ROTARY - Tondeuses

Tous modèles	0,70	BR2-LM	5798	06	4740
--------------	------	--------	------	----	------

YORK - Tondeuses

Tous modèles	0,70	BR2-LM	5798	06	4740
--------------	------	--------	------	----	------

ZENOAH - Générateurs

G 1A / 1A6 14.9cc	0,60	BM6A	5921	01	5478
G 1E 17.2cc	0,60	BMR6A	7421	01	5478
G 2A 22.5cc	0,60	BM6A	5921	01	5478
G 2A16 / 2C / 2D / 2D30 22.5cc	0,60	BM7A	6521	10	6793
G 2D70-D	0,60	BMR7A	4226	10	6793
G 3C / 3C76 31.7cc	0,70	B6HS	4510	-	-
G 3D10 / 3D20 31.7cc	0,60	BPM6A	7021	08	5063
G 3E 25.4cc	0,60	BMR6A	7421	01	5478
G 4C / 4C63 / 4C76 37.4cc	0,70	B6HS	4510	-	-
G 5C 52.5cc	0,70	BR6S	3522	09	6048
G 5E / 5E2 52.5cc	0,70	B6HS	4510	-	-
G 23LH	0,70	BPM7A	7321	02	5959
G 230PUH / 230PUM	0,60	BMR7A	4226	10	6793
G 230RC, 231PUH / PUM, 260 PUH / PUM / RC	0,70	CMR7H	3066	-	-
G 380PU, G 450PU, G 620PU, G 800BPU	0,50	BPMR7A	4626	02	5959
MD 20AE	0,60	BM7A	6521	10	6793
MD 40AE	0,70	B6HS	4510	-	-

ZENOAH - Outils Divers

EB 20	0,60	BM7A	6521	10	6793
EB 40 / 43	0,70	B6HS	4510	-	-
FAG 10	0,70	B6S	3510	09	6048

ZENOAH - Tronçonneuses

CHTZ6000 & CHTZ75000 - Mot. GZ23N	1,00	CMR7H-10	1656	-	-
HTZ7500 & LRTZ2610 - Mot. GZ23N	1,00	CMR7H-10	1656	-	-
PSZ2610 & SRTZ2610/F - Mot. GZ25N	1,00	CMR7H-10	1656	-	-

ZIPPER - Tondeuses

Mot. 3 cyl. (Refr. liquide) 31 hp	0,90	BKR5E	7938	07	4803
Mot. B&S 14 / 18 hp Vanguard V-Twin	0,90	BKR5E	7938	07	4803
Mot. B&S 18 hp	0,60	BKR5ES	2460	07	4803
Mot. Kohler 18 / 20 / 22 / 25 hp V-Twin	0,90	BKR5E	7938	07	4803
Mot. Kohler 20 / 22 hp	0,60	BKR5ES	2460	07	4803



STOCK-TYPE BOUGIES D'ALLUMAGE

Top Vente	NGK	N° Stock	N° BLISTER N° Stock	TYPES D'APPLICATIONS	MARQUES	BOSCH	CHAMPION
1	BPMR7A Ø : 14mm, L : 9,5mm clé de 19	4626	02 5959	DEBROUSSAILLEUSES GENERATEURS TRONCONNEUSES	ALPINA, CUB CADET, DOLMAR, ECHO, EFCO, HOMELITE, HUSQVARNA, JONSERED, MAKITA, OLEO-MAC, PARTNER, POULAN, SOLO, STIHL, ZENOAH	WSR5F WSR6F	RCJ6Y RCJ7Y
2	BPR5ES Ø : 14mm, L : 19mm clé de 20,8	7422	03 6854	DEBROUSSAILLEUSES GENERATEURS ENGIN MANUTENTION TONDEUSES	CUB-CADET, HONDA, HUSQVARNA, JOHN DEERE, KAWASAKI, MISTUBISHI, OLEO- MAC, STAUB, SOLO, STAUB, SUZUKI, YAMAHA	WR8DC WR9DC	RN11YC-OE051 RN12YC-OE042
3	BPR6ES Ø : 14mm, L : 19mm clé de 20,8	7822	04 7678	GENERATEURS ENGIN MANUTENTION TONDEUSES	AGRIA, ARCTIC CAT, EFCO, GENERAC, HONDA, HUSQVARNA, OLEO-MAC, SOLO, STAUB, SUZUKI	WR6DC WR7DC	RN9YC-OE006 RN9YCC-OE004 RN10YC-OE111
4	BCPR5ES Ø : 14mm, L : 19mm clé de 16	6130	07 4803	GENERATEURS TONDEUSES	BRIGGS & STRATTON, HUSQVARNA, KOHLER, OLEO-MAC, SABRE, SOLO, STAUB	/	/
5	BM6A Ø : 14mm, L : 9,5mm clé de 19	5921	01 5478	DEBROUSSAILLEUSES GENERATEURS TONDEUSES TRONCONNEUSES	ECHO, HARRY, HUSQVARNA, KAWASAKI, MITSUBISHI, PARTNER, POULAN, SHINDAIWA, TANAKA	WS6E WS7E WS8E	CJ8 CJ11 CJ86
6	BR2-LM Ø : 14mm, L : 9,5mm clé de 20,8	5798	06 4740	GENERATEURS TONDEUSES	ARIENS, BRIGGS & STRATTON, CUB- CADET, EFCO, ERING, HARRY, HERKULES, HUSQVRANA, OLEO-MAC, SOLO, STAUB, TECUMSEH, TORO, VIKING, WOLF	WR11E	RJ19LM
7	CMR6H Ø : 10mm, L : 12,7mm clé de 16	3365	12 4794	DEBROUSSAILLEUSES GENERATEURS TRONCONNEUSES	HUSQVARNA, STIHL	USR4AC USR7AC	/
8	B4-LM Ø : 14mm, L : 9,5mm clé de 20,8	3410	05 4358	GENERATEURS TONDEUSES	AGRIA, ERING, FLYMO, HARRY, TECUMSEH, WOLF	W9ECO W9EO W11EO	CJ17LM J17LM
9	BMR6A Ø : 14mm, L : 9,5mm clé de 19	7421	01 5478	DEBROUSSAILLEUSES GENERATEURS TONDEUSES TRONCONNEUSES	CUB CADET, ECHO, FLYMO, HOFFCO, JOHN DEERE, KAWASAKI, McCULLOCH, PIONEER, POULAN, SHINDAIWA, SOLO, STILH, TANAKA, TORO, WOLF	WSR8E	RCJ8
10	B6HS Ø : 14mm, L : 12,7mm clé de 20,8	4510	/	GENERATEURS	FUJI-ROBIN, KAWASAKI, TECUMSEH	W7AO W7A00 W175T1	L82C L86C
11	B7HS Ø : 14mm, L : 12,7mm clé de 20,8	5110	/	DEBROUSSAILLEUSES GENERATEURS	FUJI-ROBIN, TOHATSU, YAMAHA	W5A W5AC W225T1	L77J L78C
12	BPMR6A Ø : 14mm, L : 9,5mm clé de 19	6726	08 5063	DEBROUSSAILLEUSES GENERATEURS TONDEUSES TRONCONNEUSES	DOLMAR, ECHO, EFCO, HUSQVARNA, KAWASAKI, JONSERED, OLEO-MAC, POULAN PRO, SOLO, STILH, TANAKA, TORO	WSR7F WSR8F	RCJ8Y RJ2YLE
13	B8HS Ø : 14mm, L : 12,7mm clé de 20,8	5510	/	GENERATEURS	ECHO, HIRTH	W3AC W4A	/
14	BPM6A Ø : 14mm, L : 9,5mm clé de 19	7021	08 5063	DEBROUSSAILLEUSES GENERATEURS TRONCONNEUSES	ECHO, HUSQVARNA, OLEO MAC, SHINDAIWA, STIHL, TANAKA, TECUMSEH	WS6F WS7F WS8F	CJ8Y



NOTES PERSONNELLES



BOUGIES DE PRÉCHAUFFAGE



BOUGIES DE PRÉCHAUFFAGE

Modèle		Type		N° STOCK	Volts
AIRMAN					
AX 15-2K / 16 / 16-2N	Kubota			YE11 97505	11V
AX 17 / 17-2N / 22 / 22CGL	Kubota			YE11 97505	11V
AX 30-2 / 35-2 / 75XGL-2	Kubota			YE11 97505	11V
AXX 22-2	Kubota			YE11 97505	11V

AMIDA					
AL5000, LP7000	Kubota			YE11 97505	11V

ATLAS					
32C	Lom. LDW 1204			Y-924J 7906	11V



BENZA					
BY-9-M, BY-9-T	Yanmar 3TNV76	Générateur		Y1022 92276	11V

BOBCAT					
425, 428, 463, 553	Kubota			YE11 97505	11V
743	Kubota V1702	Manutention		Y-106V 6926	10,5V
750	4 Cyl.	1998->		Y-716RS 4693	11V
763	Kubota	V 2203-E		Y-716RS 4693	11V
843 / B / C / H / HC, 853	Isuzu 4JB1			Y-904R1 90958	11V
7753	Kubota	Manutention		Y-716RS 4693	11V
B 100B	Kubota			YE11 97505	11V
B 200 / B250	Kubota			YE11 97505	11V
S 70 / 100	Kubota			YE11 97505	11V
	Kubota V1920	Manutention		Y-106V 6926	10,5V
	Kubota 3 cyl.			YE01 2649	11V

BOMAG					
BMP 8500	Kubota	Compacteur		YE11 97505	11V
BW 131 ACW / AD	Kubota	Compacteur		YE11 97505	11V

BRIGGS & STRATTON					
24.5 hp	Daihatsu D070			Y-601J 92785	11V

CARRIER					
Maxima 1000	Kubota			YE11 97505	11V
Maxima 1300 / 1300 MT	Kubota			YE11 97505	11V
NDA 93 / 94B	Kubota			YE11 97505	11V
Optima	Kubota			YE11 97505	11V
	Kubota	Groupe frigorifique		YA01 5727	12,5V

Modèle		Type		N° STOCK	Volts
CASE					
460	Kubota			YE11 97505	11V
9007B	Isuzu 4JB1			Y-904R1 90958	11V
Maxi-Sneaker Série C	Kubota			YE11 97505	11V

COMBILIFT					
C 2500 / 2500EST / 3000	Kubota			YE11 97505	11V
Combi-CB	Kubota			YE11 97505	11V

CUB CADET					
Compact 5264DE 26 hp	Daihatsu D070	Tracteur		Y-601J 92785	11V
Compact 7264 21 hp (98-04)	Daihatsu D070	Tracteur		Y-601J 92785	11V
Compact 7304 30 hp (98-03)	Daihatsu D070	Tracteur		Y-601J 92785	11V
Tanks S Zero-Turn S6032-D		Tondeuse		Y-546J 95275	11V
Tanks S Zero-Turn S7232-D		Tondeuse		Y-546J 95275	11V
Utility 7264 3-59 21 hp	Daihatsu D070	Tracteur		Y-601J 92785	11V

DAEWOO					
D 100	Daihatsu D070	Manutention		Y-601J 92785	11V

DAIHATSU					
	D070			Y-601J 92785	11V

DENYO					
DCW 480ESW	Kubota	Soudeur		YE11 97505	11V
DLW 380SDK / 400ESW	Kubota	Soudeur		YE11 97505	11V
TLG 12ESX	Yanmar			Y1022 92276	11V
TLW 380SSWK	Kubota	Soudeur		YE11 97505	11V

DEUTZ					
25, 30, 40, 2505, 3005, 4005 FL 812		Tracteur		Y-810 6929	10,5V
4505, 5005, 6005, 8005, 9005 FL 812		Tracteur		Y-810 6929	10,5V

DIAMOND PRODUCTS					
CC 4144D, CC 4144XL	Kubota	Scie		YE11 97505	11V

DITCHWITCH					
FM 25	Kubota	Pompe		YE11 97505	11V
HT 25	Kubota	Machine pr tranchée		YE11 97505	11V
JT 5 / JT 520	Kubota	Alésior directionnel		YE11 97505	11V
RT 30	Kubota	Machine pr tranchée		YE11 97505	11V
XT 850	Kubota	Manutention		YE11 97505	11V

Modèle		Type		N° STOCK	Volts 
--------	---	------	---	----------	---

DOORSAN

Solar 55	Isuzu 4JB1	Manutention	Y-904R1	90958	11V
----------	------------	-------------	---------	-------	-----

EAGLE TUGS

TT 4 / 5 / 6 / 8 / 10 / 12	Isuzu 4JB1	Transport d'avions	Y-904R1	90958	11V
----------------------------	------------	--------------------	---------	-------	-----

EARTHFORCE

EF 1D / 1TD / 2	Kubota		YE11	97505	11V
-----------------	--------	--	------	-------	-----

FERRIS

ZTR	Yan.3TNNV82A	Tondeuse	Y-546J	95275	11V
-----	--------------	----------	--------	-------	-----

FORD

1300 / 1600		Tracteur	Y-401-3	2226	10,5V
1925 (1992-1999)		Tracteur	Y-107V	6628	10,5V

FUJI-ROBIN

DY 8 / 40 / 80			Y-401-3	2226	10,5V
----------------	--	--	---------	------	-------

GEHL

353, 373, 503Z			Y-546J	95275	11V
602, 802	Yanmar 4TNE98		Y1021J	97627	11V
3635, 3640E, 3935, 4240E			Y-546J	95275	11V
CTL 55	Yanmar 4TNNV88		Y-546J	95275	11V
CTL 55	Yanmar 4TNE98		Y1021J	97627	11V
CTL 60			Y-546J	95275	11V
GE 652	Yanmar 4TNE98		Y1021J	97627	11V
R 135, R 150			Y-546J	95275	11V

GENIE

GS 2669RT / 3369RT	Kubota	Nacelle	YE11	97505	11V
GS 4069RT	Kubota	Nacelle	YE11	97505	11V

GOLDONI

Boxer 20	Yanmar		Y1022	92276	11V
----------	--------	--	-------	-------	-----

HINOMOTO

C 142, C 144, C 172, C 174		Tracteur	Y-112T	6327	11V
E 322 / 324 / 382 / 384		Tracteur	Y-122	6925	10,5V
E 392 / 394		Tracteur	Y-122	6925	10,5V
E 402 / 404 / 2302 / 2304		Tracteur	Y-112T	6327	11V
E 2802 / 2804		Tracteur	Y-122	6925	10,5V
JF 1		Tracteur	Y-112T	6327	11V
JF 1 IC Glow System		Tracteur	Y-702R	1065	11V

Modèle		Type		N° STOCK	Volts 
--------	---	------	---	----------	---

HITACHI

6M1	Yanmar	Manutention	Y1022	92276	11V
EX 12-2 / 15-2 / 16-2B / 17-2B	Kubota		YE11	97505	11V
EX 18-2 / 20UR-2C / 22-2	Kubota		YE11	97505	11V
EX 25-2 / 30-2 / 30UR-2C	Kubota		YE11	97505	11V
EX 30UR-3 / 35-2 / 40UR-3	Kubota		YE11	97505	11V
EX 60URG	Isuzu 4JB1		Y-904R1	90958	11V
LX 15-7 / 15SL-7	Kubota		YE11	97505	11V
VR 308 / 308-2 / 408 / 408-2	Kubota	Compacteur	YE11	97505	11V
ZX 10U-2 / 17U-2 / 22U-2	Yanmar 3TNNV70		Y1022	92276	11V
ZX 27-3 / 30 / 30UR	Kubota		YE11	97505	11V
ZX 35 / 40UR	Kubota		YE11	97505	11V
ZX 8-2	Yanmar		Y1022	92276	11V

HONDA

EXT 12 D		Générateur	Y-703R	3782	11V
H 6522		Tracteur	Y-703R	3782	11V

HUSQVARNA

PZ 6029D	Kubota	Tracteur	YE11	97505	11V
----------	--------	----------	------	-------	-----

HUSTLER

3400 / 6400	Kubota	Tracteur	YE11	97505	11V
-------------	--------	----------	------	-------	-----

IHI CONSTRUCTION MACHINERY LIMITED

8NX	Yanmar 2TNNV70		Y1022	92276	11V
15NX, PX17	Yanmar 3TNNV70		Y1022	92276	11V

IMER

20 VX, 25 VX	Yanmar 3TNNV76	Mini-pelle	Y1022	92276	11V
25 J	Isuzu 3LB1	Mini-pelle	Y-720U1	5392	10V
HD 307	Isuzu 4JB1	Mini-pelle	Y-904R1	90958	11V
NX 18 / 25 / 30	Isuzu 3LB1	Mini-pelle	Y-720U1	5392	10V

INGERSOLL-RAND

L8B-4MH, L8C-4MH	Kubota	Tour d'éclairage	YE11	97505	11V
------------------	--------	------------------	------	-------	-----



ISEKI

-	Mitsubishi 3 Cyl.		Y-114T	6528	10,5V
ICT		Porte-outils	Y-510R	91712	11V
SF 200 / 200 M / 230 / 230 M		Tondeuse	Y-510R	91712	11V
SF 303		Tondeuse	Y-510R	91712	11V
SF 310	3 Cyl. 31hp	Tondeuse	Y-510R	91712	11V
SF 310 F / 333		Tondeuse	Y-510R	91712	11V
SF 370	3 Cyl. 37hp	Tondeuse	Y-510R	91712	11V
SF 370 F / 438 / 450		Tondeuse	Y-510R	91712	11V
SFH 220 / 240	3 Cyl. 1123cc	Tondeuse	Y-510R	91712	11V
SFH 220 F / 240 F		Tondeuse	Y-510R	91712	11V
SG 15 / 152 / 153 H / 173 H		Tondeuse	Y-510R	91712	11V
SGR 17 / 19		Tondeuse	Y-510R	91712	11V

Modèle		Type		N° STOCK		Volts
ISEKI						
SXG 15 H		Tondeuse	Y-510R	91712	11V	
SXG 19 (n° Série 226284 →)	3 Cyl. 20hp	Tondeuse	Y-510R	91712	11V	
SXG 19 F / 19 H		Tondeuse	Y-510R	91712	11V	
SXG 22 (n° Série 226314 →)	3 Cyl. 24hp	Tondeuse	Y-510R	91712	11V	
SXG 22 F / 22 H		Tondeuse	Y-510R	91712	11V	
SXG 216 H / 216 H3		Tondeuse	Y-510R	91712	11V	
SXG 323 23hp	E3112-B12	Tondeuse	Y-510R	91712	11V	
SXG 323 H / 323 H3		Tondeuse	Y-510R	91712	11V	
SXG 326 23hp	E3112-B12	Tondeuse	Y-510R	91712	11V	
SXG 326 H / 326 H3		Tondeuse	Y-510R	91712	11V	
SZ 330	3 Cyl. 33hp	Tondeuse	Y-510R	91712	11V	
SZ 330 F		Tondeuse	Y-510R	91712	11V	
T 5010 / 6010 / 6020	Isuzu 4BC2	Tracteur	Y-904R1	90958	11V	
TF 327		Tracteur	Y-510R	91712	11V	
TG 5330	3 Cyl. 33hp	Tracteur	Y-510R	91712	11V	
TG 5330 E4 Type C / R / S		Tracteur	Y-510R	91712	11V	
TG 5330 E6		Tracteur	Y-510R	91712	11V	
TG 5390	3 Cyl. 40hp	Tracteur	Y-510R	91712	11V	
TG 5390 E4 Type C / R / S		Tracteur	Y-510R	91712	11V	
TG 5390 E6, TG 5395		Tracteur	Y-510R	91712	11V	
TG 5470	3 Cyl. 48hp	Tracteur	Y-510R	91712	11V	
TG 5470 E4 M / Q		Tracteur	Y-510R	91712	11V	
TG 5470 E4 Type CY / S		Tracteur	Y-510R	91712	11V	
TG 5470 E6 (Sauf Type CY)		Tracteur	Y-510R	91712	11V	
TG 5475 FH		Tracteur	Y-510R	91712	11V	
TH 4260 / 4260 H	3 Cyl. 26hp	Tracteur	Y-510R	91712	11V	
TH 4290	3 Cyl. 29hp	Tracteur	Y-510R	91712	11V	
TH 4290 E6		Tracteur	Y-510R	91712	11V	
TH 4290 H (→n° 010138)		Tracteur	Y-510R	91712	11V	
TH 4295	3 Cyl. 29hp	Tracteur	Y-510R	91712	11V	
TH 4330	3 Cyl. 33hp	Tracteur	Y-510R	91712	11V	
TH 4330 E4 / E6		Tracteur	Y-510R	91712	11V	
TH 4330 H (→n° 010158)		Tracteur	Y-510R	91712	11V	
TH 4335 / 4365		Tracteur	Y-510R	91712	11V	
TK 527 / 532 / 538 / 538 H		Tracteur	Y-510R	91712	11V	
TK 553		Tracteur	Y-510R	91712	11V	
TM 223 23hp	E3112-B12	Tracteur	Y-510R	91712	11V	
TM 3160	3 Cyl. 928cc 16hp	Tracteur	Y-510R	91712	11V	
TM 3200	Isuzu	Tracteur	Y-510R	91712	11V	
TM 3200 E4 / E6		Tracteur	Y-510R	91712	11V	
TM 3240 / E4 / E6		Tracteur	Y-510R	91712	11V	
TXG 23 23hp	E3112-B12	Tondeuse	Y-510R	91712	11V	
TXG 23 FH / TH		Tondeuse	Y-510R	91712	11V	
TXG 237 23hp	E3112-B12	Tondeuse	Y-510R	91712	11V	
TXG 237 FM	E3112-B12 23hp	Tondeuse	Y-510R	91712	11V	

ISHIKAWAJIMA-SHIBAURA

CM 224 (S753) / 274 (J823)		Y-701J	1566	11V
DL, LFD		Y-401-3	2226	10,5V
E 642 / 643	Tracteur	Y-107V	6628	10,5V
E 672		Y-701J	1566	11V
H 763 / 843	Tracteur	Y-107V	6628	10,5V
IFD	Tracteur	Y-401-3	2226	10,5V
J 774 / 774 T		Y-701J	1566	11V
J 823 / 843, K 713 / 773	Tracteur	Y-107V	6628	10,5V
LE 852 / 892 / 903	Tracteur	Y-401-3	2226	10,5V
LEH 822	Tracteur	Y-107V	6628	10,5V
LEK 752C / 802D	Tracteur	Y-107V	6628	10,5V
LEM 754A / 754AT	Tracteur	Y-107V	6628	10,5V
LEM 853 / 854 A	Tracteur	Y-107V	6628	10,5V
LET 802 C / 852 C	Tracteur	Y-401-3	2226	10,5V
LGT (E643), LGT 16 (E673)		Y-701J	1566	11V
MWM	Tracteur	Y-401-3	2226	10,5V
N 843 DI	Tracteur	Y-119V	7465	10,5V
N 844	Tracteur	Y-701J	1566	11V
N 844 L		Y-107V	6628	10,5V
S 723 / S 753 / S 773		Y-701J	1566	11V
S 773 L		YE01	2649	11V

Modèle		Type		N° STOCK		Volts
ST 321		Tracteur	Y-701RS	2765	11V	
T 854 B			Y-107V	6628	10,5V	
T 854 B-DI			Y-119V	7465	10,5V	
T 854 B-DI(T/C)			Y-119V	7465	10,5V	
T 854 BT			Y-701J	1566	11V	
U 1004		Tracteur	Y-107V	6628	10,5V	

ISUZU

2CA1 General Utility	Yanmar		Y1022	92276	11V
2CA1 Generator	Yanmar		Y1022	92276	11V
3 Cylindres	3LA1, 3LB1, 3LD1	Manutention	Y-720U1	5392	10V
3CA1 General Utility	Yanmar 3TNNV70		Y1022	92276	11V
3CA1 Generator	Yanmar 3TNNV70		Y1022	92276	11V
	Code mot. 276346	Mini-pelle	Y-720U1	5392	10V
	4BC2	Générateur	Y-904R1	90958	11V

JACOBSEN

AR-3, AR-250, AR-2500	Kubota	Tondeuse	YE11	97505	11V
CR-80	Kubota	Tondeuse	YE11	97505	11V
HR-4600 Turbo	Kubota	Tondeuse	YE11	97505	11V
LF-510 / 550 / 550 Turbo	Kubota	Tondeuse	YE11	97505	11V
LF-570 / 570 Turbo	Kubota	Tondeuse	YE11	97505	11V
LF-1880 / 3400 / 3800	Kubota	Tondeuse	YE11	97505	11V
LF-4675 T., LF-4677 Turbo	Kubota	Tondeuse	YE11	97505	11V
SLF-1880 / 1880 Turbo 4WD	Kubota	Tondeuse	YE11	97505	11V
Super LF-1880 / 1880 4WD	Kubota	Tondeuse	YE11	97505	11V
TR-3	Kubota	Tondeuse	YE11	97505	11V

JCB

JS 070 / 70	Isuzu 4JB1		Y-904R1	90958	11V
-------------	------------	--	----------------	--------------	------------

JLG

260 MRT, 340 AJ	Kubota	Nacelle	YE11	97505	11V
600 A / AJ / S / SJ	Isuzu 4JB1	Nacelle	Y-904R1	90958	11V

JOHN DEERE

2500 B / E, 2653 B	Yanmar 3TNNV70	Tondeuse	Y1022	92276	11V
4X2 / 4X4 HPX Gator	Yanmar 3TNNV70		Y1022	92276	11V
XUV Gator	Yanmar 3TNNV70		Y1022	92276	11V
	3TN66-UJ	Tracteur	Y-702R	1065	11V
	3TNA72-UJ	Tracteur	Y-702R	1065	11V

KATO



Mule 2510 Diesel (00-02)	Isuzu 4JB1	Grue	Y-904R1	90958	11V
--------------------------	------------	------	----------------	--------------	------------

KOBELCO

4D 120	Isuzu 4JB1	Manutention	Y-904R1	90958	11V
K 903C		Manutention	Y1021J	97627	11V
K 903II	Isuzu 4JB1	Manutention	Y-904R1	90958	11V
SK 60 / 60 IV / 60 MKV	Isuzu 4JB1	Manutention	Y-904R1	90958	11V
Z 66RP	Yanmar 2TNNV70	Manutention	Y1022	92276	11V

KOMATSU

4D84E (3FB/3B/3C/3D/3E)		Manutention	Y1021J	97627	11V
B 1200		Générateur	Y1021J	97627	11V
FD 20 / FD 30	4 D95 / S - 4 cyl.	Manutention	Y-703M1	93386	11V
PC 09-1 / 10MR-2 / 10UU-5	Yanmar		Y1022	92276	11V
PC 40-7 / 40MRX-1-E / 40R-8			Y1021J	97627	11V
PC 45MRX-1-E / 45R-8			Y1021J	97627	11V
SK 510 / SK 815 / SK 820			Y1021J	97627	11V

Modèle		Type		N° STOCK	Volts 
KUBOTA					
B 1200	D750L	Tracteur	Y-103V	2031	10,5V
B 1400 / B 1402 DT	D850L	Tracteur	Y-103V	2031	10,5V
B 1500 / B 1502 DT	D850M	Tracteur	Y-103V	2031	10,5V
B 1550	D850-5B	Tracteur	Y-702R	1065	11V
B 1600 / B 1702 / B 1902	D950	Tracteur	Y-103V	2031	10,5V
B 1750	D9500-5B	Tracteur	Y-702R	1065	11V
B 1902 DT	DM1102	Tracteur	Y-106V	6926	10,5V
B 2150	D1200-5B	Tracteur	Y-702R	1065	11V
B 2910 HSD	Kubota	Tracteur	YE11	97505	11V
B 3000 HSDC / HSDCC	Kubota	Tracteur	YE11	97505	11V
B 3030HSD / HSDC / HSDCC	Kubota	Tracteur	YE11	97505	11V
B 3200 HSD / HSDWO	Kubota	Tracteur	YE11	97505	11V
B 3300 SUHSD	Kubota	Tracteur	YE11	97505	11V
B 3350 HSD / HSDC	Kubota	Tracteur	YE11	97505	11V
B 3350 SUHSD	Kubota	Tracteur	YE11	97505	11V
B 4200	Kubota	Tracteur	YE11	97505	11V
B 4200	Z600-A	Tracteur	Y-103V	2031	10,5V
B 5001	Z5001-1	Tracteur	Y-103V	2031	10,5V
B 5100	Z500-1A	Tracteur	Y-103K	6325	10,5V
B 5200	D750-LA	Tracteur	Y-103V	2031	10,5V
B 6100	D650A	Tracteur	Y-103K	6325	10,5V
B 6200	D850-LA-1	Tracteur	Y-103V	2031	10,5V
B 7000	Z650	Tracteur	Y-106-1	6525	10,5V
B 7001	D750	Tracteur	Y-103K	6325	10,5V
B 7100	D750A	Tracteur	Y-103K	6325	10,5V
B 7200	D950-LAH	Tracteur	Y-103V	2031	10,5V
B 7800HSD / HSD-F / HSD-R	Kubota	Tracteur	YE11	97505	11V
B 8200	D950	Tracteur	Y-103V	2031	10,5V
B 9200	V1200-A	Tracteur	Y-103V	2031	10,5V
D 662 / 722			YE01	2649	11V
D 905 / 1005 / 1105			Y-709R	3238	11V
D 1105 / 1105-T / 1305			YE11	97505	11V
D 1703-M	3 Cyl. Euro 5		Y-716RS	4693	11V
F 2400	Kubota D1005/D1105	Tracteur	YE11	97505	11V
F 3560 / 3680, FZ 2400	Kubota	Tracteur	YE11	97505	11V
G 1700	D662-L	Tracteur	YE01	2649	11V
G 1800	D722	Tracteur	YE01	2649	11V
GL 240 K / 280 K	D1463-LN	Tracteur	Y-716RS	4693	11V
GL 3500	ZB400-GL	Tracteur	Y-103V	2031	10,5V
GL 4500 / 4500 S	ZB500-GL	Tracteur	Y-103V	2031	10,5V
GL 5500 / 5500 S / 6500 S	ZB600-GL	Tracteur	Y-103V	2031	10,5V
KD-15	Z751BD	Manutention	Y-106-1	6525	10,5V
KH-1 / KH-10	D1100BH	Manutention	Y-106-1	6525	10,5V
KH-5H	Z600-K1	Manutention	Y-103V	2031	10,5V
KH-8	D850	Manutention	Y-103K	6325	10,5V
KH-11H	D1302	Manutention	Y-106V	6926	10,5V
KH-12FD	D1402	Manutention	Y-106V	6926	10,5V
KH-14 / 15	D1301	Manutention	Y-106-1	6525	10,5V
KH-18	S2200	Manutention	Y-106-1	6525	10,5V
KH-18-2 / KH-8H-2	D850-BH	Manutention	Y-103V	2031	10,5V
KH-20	VT1502	Manutention	Y-106V	6926	10,5V
KH-31 / 35 / 50		Manutention	Y-103V	2031	10,5V
KX 36-2 / 41-2 / KX 41-2S	Kubota	Manutention	YE11	97505	11V
KX 41H / 61-2 / KX 61-2S	Kubota	Manutention	YE11	97505	11V
KX 71-2 / 71-3 / 71-3S / 71H	Kubota	Manutention	YE11	97505	11V
KX 91-2 / 91-2S	Kubota	Manutention	YE11	97505	11V
L 175 / 1501	Z751	Tracteur	Y-106-1	6525	10,5V
L 185	Z751-A	Tracteur	Y-106-1	6525	10,5V
L 235 / L 2050 / L 2350	D1102-A	Tracteur	Y-106V	6926	10,5V
L 245	D1101-A	Tracteur	Y-106-1	6525	10,5V
L 245-2	D1102-A	Tracteur	Y-106V	6926	10,5V
L 275	D1302-A	Tracteur	Y-106V	6926	10,5V
L 295	D1301A	Tracteur	Y-106-1	6525	10,5V
L 295-2	D1302-A	Tracteur	Y-106V	6926	10,5V
L 305	D1302DA	Tracteur	Y-106V	6926	10,5V
L 345	V1501DA	Tracteur	Y-106-1	6525	10,5V
L 1802	D1102	Tracteur	Y-106V	6926	10,5V
L 1802	D1102-A	Tracteur	Y-106V	6926	10,5V
L 2002	D1302	Tracteur	Y-106V	6926	10,5V
L 2201	DH1101	Tracteur	Y-106-1	6525	10,5V
L 2202	D1402-L	Tracteur	Y-106V	6926	10,5V
L 2250	D1302-DI-A	Tracteur	Y-119V	7465	10,5V
L 2402	D1402	Tracteur	Y-106V	6926	10,5V
L 2550	D1402-DI-A	Tracteur	Y-119V	7465	10,5V
L 2601	V1502-L	Tracteur	Y-106V	6926	10,5V
L 2602	VT1502	Tracteur	Y-106V	6926	10,5V

Modèle		Type		N° STOCK	Volts 
L 2650	D1402-DI-A	Tracteur	Y-119V	7465	10,5V
L 2802 / 3202	V1502	Tracteur	Y-106V	6926	10,5V
L 2850	D1402-DI-A	Tracteur	Y-119V	7465	10,5V
L 2950	D1402-DI-A	Tracteur	Y-119V	7465	10,5V
L 3001	V1501-A	Tracteur	Y-106-1	6525	10,5V
L 3250 / L 3350 / L 3450	V1902-DI-A	Tracteur	Y-119V	7465	10,5V
L 3602 / 3602 DT	V1902	Tracteur	Y-106V	6926	10,5V
L 3750	F2302-DI-L	Tracteur	Y-119V	7465	10,5V
L 4150	F2302-DI	Tracteur	Y-119V	7465	10,5V
L 4201 / 4202 / 4212	V1502	Tracteur	Y-106V	6926	10,5V
L 4202 / 4202 DT / 4212	VT1502	Tracteur	Y-106V	6926	10,5V
L 4350	V2303-DI	Tracteur	Y-119V	7465	10,5V
L 4850	F2503-DI	Tracteur	Y-119V	7465	10,5V
L 5450	F2803-DI	Tracteur	Y-119V	7465	10,5V
M 10570	F5400	Tracteur	Y-203V	7728	10,5V
M 4000	S2600	Tracteur	Y-106-1	6525	10,5V
M 4030	S2602-DI	Tracteur	Y-119V	7465	10,5V
M 4500	S2600-A	Tracteur	Y-106-1	6525	10,5V
M 4950	S2800	Tracteur	Y-106V	6926	10,5V
M 5000	D3000	Tracteur	Y-203	2532	10,5V
M 5030	S2802-DI	Tracteur	Y-119V	7465	10,5V
M 5270	D3000-1	Tracteur	Y-203V	7728	10,5V
M 5500	D3000-A	Tracteur	Y-203	2532	10,5V
M 5950 / 6030	D3200	Tracteur	Y-203V	7728	10,5V
M 5970	D3200-1	Tracteur	Y-203V	7728	10,5V
M 6000	V4000-L	Tracteur	Y-203	2532	10,5V
M 6950	V4000-2	Tracteur	Y-203V	7728	10,5V
M 6970	V4000-3, 4	Tracteur	Y-203V	7728	10,5V
M 7000	V4000	Tracteur	Y-203	2532	10,5V
M 7030	V3200, V4000	Tracteur	Y-203V	7728	10,5V
M 7500	V4000-A	Tracteur	Y-203	2532	10,5V
M 7950	V4300	Tracteur	Y-203V	7728	10,5V
M 7970	V4300-1	Tracteur	Y-203V	7728	10,5V
M 8030	V4300	Tracteur	Y-203V	7728	10,5V
M 9570	V4300-T1	Tracteur	Y-203V	7728	10,5V
M 9950	V4300-T	Tracteur	Y-203V	7728	10,5V
NX 1000	Z600	Moissonneuse Bat.	Y-103V	2031	10,5V
NX 1100	ZB500	Moissonneuse Bat.	Y-103K	6325	10,5V
NX 1300	ZB600	Moissonneuse Bat.	Y-103K	6325	10,5V
NX 1500	D850C	Moissonneuse Bat.	Y-103K	6325	10,5V
NX 1600 / 2200	D950	Moissonneuse Bat.	Y-103V	2031	10,5V
NX 1800	D850	Moissonneuse Bat.	Y-103K	6325	10,5V
NX 2000	D950C	Moissonneuse Bat.	Y-103V	2031	10,5V
NX 3000	D1301	Moissonneuse Bat.	Y-106-1	6525	10,5V
NX 3000-1	V1502	Moissonneuse Bat.	Y-106V	6926	10,5V
OC 52 / 62 / 80 / 95			Y-709R	3238	11V
RC 8FD	Z500K1	Manutention	Y-103K	6325	10,5V
RC 15FD	D750K1	Manutention	Y-103K	6325	10,5V
RC 20	ZB500C-1K	Manutention	Y-103K	6325	10,5V
RC 20FD	D1402	Manutention	Y-106V	6926	10,5V
RC 25	ZB600C-1K	Manutention	Y-103K	6325	10,5V
RW 25	Kubota	Manutention	YE11	97505	11V
RW-25	V1500 BDW		Y-106-1	6525	10,5V
RX 550	E75-C2	Moissonneuse Bat.	Y-103V	2031	10,5V
RX 700	E75-C	Moissonneuse Bat.	Y-103V	2031	10,5V
RX 750	ZB400-C2	Moissonneuse Bat.	Y-103V	2031	10,5V
RX 900	ZB400	Moissonneuse Bat.	Y-103V	2031	10,5V
RX 1100	Z600-C1	Moissonneuse Bat.	Y-103V	2031	10,5V
RX 1300	Z620C	Moissonneuse Bat.	Y-103V	2031	10,5V
RX 1450	D640-C	Moissonneuse Bat.	Y-103V	2031	10,5V
RX 1500	D750	Moissonneuse Bat.	Y-103K	6325	10,5V
RX 1500 / 1550	D750-C	Moissonneuse Bat.	Y-103V	2031	10,5V
RX 1900	D850-C2	Moissonneuse Bat.	Y-103V	2031	10,5V
RX 2100	D950-C	Moissonneuse Bat.	Y-103V	2031	10,5V
RX 2450	V1200-C	Moissonneuse Bat.	Y-103V	2031	10,5V
RX 2800	DH1402-C	Moissonneuse Bat.	Y-103V	2031	10,5V
RX 3250	D1462 DI-C	Moissonneuse Bat.	Y-119V	7465	10,5V
RX 3250	DH62DI-C	Moisson			

Modèle		Type		N° STOCK		Volts
--------	--	------	---	----------	---	-------

KUBOTA

Z 482			YE01	2649	11V
Z 602			Y-149	6766	12,5V
ZB 600 C-I			Y-149	6766	12,5V

LASTEK

2872 Séries / 2886 Séries	Kubota	Tondeuse	YE11	97505	11V
3682 Séries / 3696 Séries	Kubota	Tondeuse	YE11	97505	11V

LINCOLN ELECTRIC

Vantage 300	Kubota	Soudeur	YE11	97505	11V
-------------	--------	---------	------	-------	-----

LINK BELT

1600 Quantum, LDW 1003	Isuzu 4JB1	Manutention	Y-904R1	90958	11V
------------------------	------------	-------------	---------	-------	-----

LOMBARDINI

LDW 502 / 602 / 702 / 903	série FOCS		Y-924J	7906	11V
LDW 1003 / 1404	série FOCS		Y-924J	7906	11V
LDW 1204 / 1204 T	série FOCS		Y-924J	7906	11V
LDW 1503	série CHD		Y-924J	7906	11V
LDW 2004 / 2004 T	série CHD		Y-924J	7906	11V

MASE

IS9	Yanmar	Générateur	Y1022	92276	11V
-----	--------	------------	-------	-------	-----

MASSEY-FERGUSON

743		Tracteur	Y-510R	91712	11V
MF 1010 / 1020 / 1030		Tracteur	Y-112T	6327	11V

MILLER ELECTRIC

Big Blue 300 Pro / 400 KX	Kubota	Soudeur	YE11	97505	11V
D 300K 3+12, D 402K 4+12	Kubota	Soudeur	YE11	97505	11V

MITSUBISHI

K 2 (S)			Y-114T	6528	10,5V
K 2 A (S)		Tracteur	Y-114T	6528	10,5V
K 2 B / C		Tracteur	Y-114T	6528	10,5V
K 3		Tracteur	Y-110	6825	10,5V
K 3 A			Y-114T	6528	10,5V
K 3 B / C / D / E / F / H / M		Tracteur	Y-114T	6528	10,5V
K 4		Tracteur	Y-110	6825	10,5V
K 4 12 / 13 / 14			Y-114T	6528	10,5V
K 4 B / C / D / E / F		Moteur Ind.	Y-114T	6528	10,5V
K 12 / K13 / K14		Moteur Ind.	Y-114T	6528	10,5V
KE 55 / 130	→ 1976.5	Moteur Ind.	Y-110	6825	10,5V
KE 70 / 70 L / 75 / 75 L		Moteur Ind.	Y-110	6825	10,5V
KE 80 / 85 / 95	→ 1976.5	Moteur Ind.	Y-110	6825	10,5V
L 2 / L 3		Moteur Ind.	Y-723U	3818	8V

MUSTANG

2060	Isuzu 4JB1		Y-546J	95275	11V
2070 / 2074	Isuzu 4JB1		Y-904R1	90958	11V

Modèle		Type		N° STOCK		Volts
--------	--	------	---	----------	---	-------

NEW HOLLAND Voir SPERRY-NEW HOLLAND**NISSAN**

CDN	SD15	Manutention	Y-112R1	1032	10,5V
CDN	SD33T	Manutention	Y-162R1	2431	23V
CEF 02	SD22 / 25	Manutention	Y-103-2	2926	9,5V
EF 02 / EF 02 A	SD22	Manutention	Y-103-2	2926	9,5V
EF 02	SD25	Manutention	Y-103-2	2926	9,5V
EF 02	SD25 12V	Manutention	Y-103	6125	10,5V
EF 02 A	SD25 12V	Manutention	Y-103-2	2926	9,5V
EF 02 / EF 02 A	SD25 24V	Manutention	Y-177-1	3026	21V
EGF 02	SD22	Manutention	Y-103-2	2926	9,5V
F 02	SD33 12V	Manutention	Y-103-2	2926	9,5V
F 03	TD42 24V	Manutention	Y-757RS	4018	24V
F 03 / F 05	SD33T	Manutention	Y-162R1	2431	23V
F 03	SD33 12V	Manutention	Y-103-2	2926	9,5V
F 05	TD42 24V	Manutention	Y-757RS	4018	24V
FD 005 / 006 / 007	SD33 12V	Manutention	Y-103	6125	10,5V
FD 005 / 006 / 007	SD33 24V	Manutention	Y-177-1	3026	21V
FX 5	TD42	Manutention	Y-162R1	2431	23V
H 01	SD15	Manutention	Y-112R1	1032	10,5V
H 01 / 02	SD25 12V	Manutention	Y-112R1	1032	10,5V
H 01 / 02	SD25 24V	Manutention	Y-162R1	2431	23V
K 02	SD25 K02 12V	Manutention	Y-103-2	2926	9,5V
K 02 1 (Type QGS)	SD25 K02 12V	Manutention	Y-112R1	1032	10,5V
LD 20 / L 28		Gpes électrogènes	Y-204TS1	3829	11V
MF 05	SD33T	Manutention	Y-177-1	3026	21V
NH 01	SD15	Manutention	Y-112R1	1032	10,5V
NH 02	SD15T 12V	Manutention	Y-112R1	1032	10,5V
NH 02	SD15T 24V	Manutention	Y-162R1	2431	23V
NSF 01 A	SD15	Manutention	Y-103-2	2926	9,5V
QF 01 / 02	SD22	Manutention	Y-103-2	2926	9,5V
QF 01 A / 02 A	SD22 12V >1980	Manutention	Y-103	6125	10,5V
QF 01 A / 02 A	SD22 12V 1981>	Manutention	Y-103-2	2926	9,5V
QF 01 A / 02 A	SD22 24V 1981>	Manutention	Y-177-1	3026	21V
QGF 02	SD22	Manutention	Y-103-2	2926	9,5V
SD 16		Gpes électrogènes	Y-112T	6327	11V
SD 16 / 22	QGS	Gpes électrogènes	Y-705RS	1249	11V
SD 22	12V	Gpes électrogènes	Y-112T	6327	11V
SD 22 / 25	24V	Gpes électrogènes	Y-755RS	7771	24V
SD 33	12V	Gpes électrogènes	Y-112T	6327	11V
SD 33	12V QGS	Gpes électrogènes	Y-705RS	1249	11V
SD 33	24V	Gpes électrogènes	Y-755RS	7771	24V
SD 33 T	24V	Gpes électrogènes	Y-177-1	3026	21V
SF 01 A	SD15	Manutention	Y-103-2	2926	9,5V
TD 23 / 27		Gpes électrogènes	Y-707RS	4937	11V
YF 03, YGF 03	SD33T	Manutention	Y-177-1	3026	21V

ONAN

Commercial HDKAG	Kubota	Générateur	YE11	97505	11V
Commercial HDKAL	Kubota	Générateur	YE11	97505	11V
Commercial HDKAQ	Kubota	Générateur	YE11	97505	11V
Commercial SD 7500	Kubota	Générateur	YE11	97505	11V
Commercial SD 10000	Kubota	Générateur	YE11	97505	11V
HQD 12/15 (Hybrid)	Kubota	Générateur	YE11	97505	11V
HQD 12/18 (Hybrid)	Kubota	Générateur	YE11	97505	11V
HQDPB (Hybrid)	Kubota	Générateur	YE11	97505	11V

RANSOMES

Fairway 305 / 405 Séries	Kubota	Tondeuse	YE11	97505	11V
--------------------------	--------	----------	------	-------	-----

SPERRY-NEW HOLLAND

Kubota 1920		Tracteur	Y-106V	6926	10,5V
9600 D	Isuzu 4JB1	Manutention	Y-904R1	90958	11V

STIGA

Titan 20B / 26H Tondeuse **Y1022 92276 11V**

SULLAIR

35 / 45 Kubota Compresseur **YE11 97505 11V**

TAKEUCHI

1DZ Manutention **Y-904R1 90958 11V**

A2C Yanmar Manutention **Y1022 92276 11V**

TB 016 / 108 / 20R Yanmar Manutention **Y1022 92276 11V**

TEREX

T 15G / T25G Kubota Générateur **YE11 97505 11V**

THOMAS

35 DT Kubota Manutention **YE11 97505 11V**

TORO

ReelMaster 3550-D (03910) Kubota Tracteur **YE11 97505 11V**

TOYOTA

2J 4FG10 **Y-128T 7227 8,5V**

VERMEER

D6 Navigator Kubota BTP **YE11 97505 11V**

V 250 / 500 Kubota BTP **YE11 97505 11V**

VOLVO

EB 200 XP Mini-pelle **Y-723R 3460 11V**

EC 27C Volvo D1.6DCAE4 Mini-pelle **Y-546J 95275 11V**

Mitsubishi Mini-pelle **Y-110 6825 10,5V**

YANMAR

2 TN 66 E / 2 TN 66 L Générateur **Y-103V 2031 10,5V**

2 TNV 70-TK Générateur **Y1022 92276 11V**

3 T 84 H Générateur **Y-110V 5243 10,5V**

3 TN 63 L / 66 L / 68 L / 72 L Générateur **Y-103V 2031 10,5V**

3 TN 63 U1C / 66 U1C **Y-702U 2966 10V**

3 TNA 68 L Générateur **Y-103V 2031 10,5V**

3 TNA 68 U / U1C / U-C **Y-702U 2966 10V**

3 TNA 72 E / J / L Générateur **Y-103V 2031 10,5V**

3 TNA 72 U1C / U2C / UBC **Y-702U 2966 10V**

3 TNA 75 RAC **Y-702U 2966 10V**

3 TNE 66 E / 68 AC / 68 L Générateur **Y-103V 2031 10,5V**

3 TNE 72, 3 TNE 74 Générateur **Y-103V 2031 10,5V**

3 TNV 70 **Y-702R 1065 11V**

3 TNV 70, 3 TNV 76 Générateur **Y1021J 97627 11V**

3 TNV 82 A (Tier 4) Générateur **Y1021J 97627 11V**

3 TNV 84 T-B (Tier 4) Générateur **Y-546J 95275 11V**

3 TNV 88 (Tier 4) Générateur **Y-546J 95275 11V**

4 T 112 Générateur **Y-546J 95275 11V**

4 TNE 84 Générateur **Y1021J 97627 11V**

4 TNE 94 Manutention **Y1021J 97627 11V**

4 TNV 84 T (Tier 4) Générateur **Y1021J 97627 11V**

4 TNV 88 (Tier 4) Générateur **Y-546J 95275 11V**

4 TNV 98-Z / 98 T-Z (Tier 4) Générateur **Y-546J 95275 11V**

EE 211 / 213 Générateur **Y1022 92276 11V**

HZ 1 Générateur **Y1022 92276 11V**

YM 12 / 14 2T75-U Tondeuse **Y-116V 2131 10,5V**



STOCK-TYPE BOUGIES DE PRÉCHAUFFAGE

Top Vente	NGK	N° Stock	TYPES D'APPLICATIONS	MARQUES
1	YE01 Ø8 - 11V Clé de 10	2649	MOTEURS INDUSTRIELS TRACTEURS VEHICULES SANS PERMIS	AIXAM, ERAD, KUBOTA
2	Y-103V Ø10 - 10,5V Clé de 12	2031	GENERATEURS MOISSONNEUSES TRACTEURS VEHICULES SANS PERMIS	AIXAM, BELLIER, JDM, KUBOTA, YANMAR
3	Y-702R Ø10 - 11V Clé de 12	1065	MINI-PELLES MOTEURS INDUSTRIELS TRACTEURS	HITACHI, JOHN DEERE, KUBOTA, YANMAR
4	Y-924J Ø12 - 11V Clé de 12	7906	MOTEURS INDUSTRIELS VEHICULES SANS PERMIS	CHATENET, ERAD, GRECAV, JDM, LIGIER, LOMBARDINI, MICROCAR
5	Y-114T Ø10 - 10,5V Clé de 12	6528	MOTEURS INDUSTRIELS TRACTEURS	ISEKI, MITSUBISHI
6	Y-110 Ø10 - 10,5V Clé de 12	6825	MINI-PELLES MOTEURS INDUSTRIELS TRACTEURS	mitsubishi, VOLVO
7	Y-103K Ø10 - 10,5V Clé de 12	6325	ENGINS MANUTENTION MOISSONNEUSES TRACTEURS	KUBOTA
8	Y-716RS Ø10 - 11V Clé de 12	4693	ENGINS MANUTENTION MOTEURS INDUSTRIELS TRACTEURS	BOBCAT, KUBOTA
9	Y-709R Ø10 - 11V Clé de 12	3238	MOISSONNEUSES MOTEURS INDUSTRIELS	KUBOTA
10	Y-116V Ø10 - 10,5V Clé de 12	2131	TONDEUSES	YANMAR
11	Y-706R Ø10 - 11V Clé de 12	3041	SSV	KAWASAKI
12	Y-720U1 Ø10 - 10V Clé de 12	5392	ENGINS MANUTENTION MINI-PELLES	IMER, ISUZU



Marine

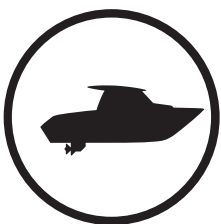

MARINE

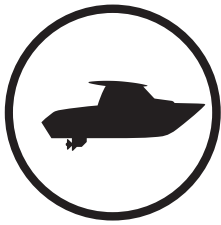

MARINE

SOMMAIRE

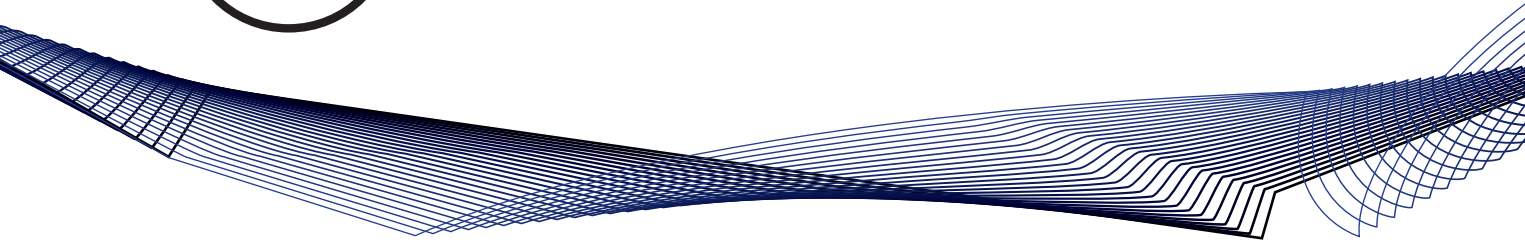

BOUGIES D'ALLUMAGE



- 224 à 239** Applications INBOARD
- 240 à 283** Applications HORS-BORD
- 284 à 291** Applications MOTONAUTISME



STOCK-TYPE

- 292** Stock-type bougies d'allumage



BOUGIES D'ALLUMAGE



Inboard



Modèle

Cyl.



N° STOCK



N° STOCK IX

AERO MARINE

165 CR Serie	66-70	0,80	BR6ES	4922	-	-
240 Serie	-	0,60	XR5	3332	XR5IX	7355
265 Serie	69-70	0,90	XR5	3332	XR5IX	7355
265 / 320 Serie	71-	1,10	UR4	6630	UR4IX	7401
304, 360 Jet, 482 Serie	-	0,80	BPR6ES	7822	BPR6EIX	6637
320 / 350 / 375 Serie	66-70	0,80	BR6ES	4922	-	-
375 Serie	70-71	1,10	UR4	6630	UR4IX	7401
427 Jet Serie	71-	1,10	UR4	6630	UR4IX	7401
454 Serie	-	1,10	UR4	6630	UR4IX	7401
455 Serie	-	0,90	XR5	3332	XR5IX	7355

ALBIN

0-1 (No.18965->)	-	0,80	AB-6	2910	-	-
0-11	-	0,80	AB-6	2910	-	-
0-1L (No.1948->)	-	0,60	B6HS	4510	BR6HIX	3419
0-2 (No.15826->)	-	0,80	AB-6	2910	-	-
0-21	-	0,60	B6HS	4510	BR6HIX	3419
0-21	-	0,80	AB-6	2910	-	-
0-41 / 0-411	-	0,80	AB-6	2910	-	-
0-4SP (No. 19325->)	-	0,80	AB-6	2910	-	-
2000 SP, A-GSP	-	0,70	BR7HS	4122	BR7HIX	7067
2000 V-1, A4	-	0,60	B6HS	4510	BR6HIX	3419
AL22, AL23, E4, E5, E6, G-6, G-6B, T-4	-	0,80	AB-6	2910	-	-
S-4, T1500 Spezial	-	0,60	B6HS	4510	BR6HIX	3419

AMECO

Moteur Ford 302 / 351W	-	0,80	WR5	2438	WR5IX	7510
------------------------	---	------	-----	------	-------	------

AMERICAN CHALLENGER

Eagle 400 / 600 / 800	-	0,50	UR5	2771	UR5IX	7177
-----------------------	---	------	-----	------	-------	------

AUSTIN

Ø 18 mm	-	0,60	AB-6	2910	-	-
Chief - Ø 14mm	-	0,60	BR6ES	4922	-	-
Healey 35 / 55 / 75 / 3300 / Skipper	-	0,60	BR6ES	4922	-	-

B & W





BW 30 / 35	-	0,60	B6ES	7310	-	-
BW 60 / 105 / 155 / 165	-	0,60	B6S	3510	-	-
LH Master, dual ign., Super, Super Special	-	0,60	B6S	3510	-	-

B.L.M.C.

850 Sea Prince 2912 cc	-	0,60	BP5ES	6511	BPR5EIX	6597
950, 1678, 3000 cc	-	0,60	B6ES	7310	-	-
1100 Vedette, 1622 Navigator 1959	-	0,60	B6ES	7310	-	-

BARR (CONVERSIONS)

BUICK						
Moteur Buick 400 / 430 cid	67-69	1,10	UR4	6630	UR4IX	7401
Moteur Buick 455 cid	70-70	1,10	UR4	6630	UR4IX	7401
Moteur Buick 455 cid	71-74	0,70	BPR5FS	2423	UR5IX	7177
CHEVROLET						
Moteur Chevrolet 194 / 230 / 250 cid	62-69	0,90	BPR5ES	7422	BPR5EIX	6597
Moteur Chevrolet 230 cid	70-	1,10	UR4	6630	UR4IX	7401

 Modèle	Cyl.				N° STOCK		N° STOCK IX
Moteur Chevrolet 250 cid		70-78	0,70	BPR5FS	2423	UR5IX	7177
Moteur Chevrolet 250 cid		79-84	1,10	UR4	6630	UR4IX	7401
Moteur Chevrolet 283 cid		55-67	1,00	XR4	5858	XR4IX	7189
Moteur Chevrolet 292 cid		63-69	0,90	BR6ES	4922	-	-
Moteur Chevrolet 292 cid		70-92	1,10	UR4	6630	UR4IX	7401
Moteur Chevrolet 302 cid		67-69	0,90	XR4	5858	XR4IX	7189
Moteur Chevrolet 307 cid		68-70	1,00	XR4	5858	XR4IX	7189
Moteur Chevrolet 307 cid		71-73	0,70	BPR5FS	2423	UR5IX	7177
Moteur Chevrolet 327 cid		61-69	0,90	XR5	3332	XR5IX	7355
Moteur Chevrolet 350 cid		71-90	1,10	UR4	6630	UR4IX	7401
Moteur Chevrolet 350 cid 2-bbl		67-70	1,00	XR4	5858	XR4IX	7189
Moteur Chevrolet 350 cid 4-bbl		70-	1,00	XR4	5858	XR4IX	7189
Moteur Chevrolet 400 cid		70-	1,00	XR4	5858	XR4IX	7189
Moteur Chevrolet 400 cid		71-90	1,10	UR4	6630	UR4IX	7401
Moteur Chevrolet 427 cid		71-72	0,90	UR5	2771	UR5IX	7177
Moteur Chevrolet 427 cid		73-90	1,10	UR4	6630	UR4IX	7401
Moteur Chevrolet 454 cid		79-89	1,10	UR4	6630	UR4IX	7401
CHRYSLER							
Moteur Chrysler 383 cid 2-bbl		60-71	0,90	BP-4	2911	XR4IX	7189
Moteur Chrysler 383 cid 4-bbl		68-71	1,00	XR4	5858	XR4IX	7189
Moteur Chrysler 383 cid Hi-Perf.		66-67	1,00	XR4	5858	XR4IX	7189
Moteur Chrysler 413 cid		63-65	0,90	BP-4	2911	XR4IX	7189
Moteur Chrysler 413 cid Hi-Perf.		63-65	1,00	XR4	5858	XR4IX	7189
Moteur Chrysler 413 cid two 4-bbl		63-64	1,00	XR4	5858	XR4IX	7189
Moteur Chrysler 440 cid 350 hp		66-71	1,00	XR4	5858	XR4IX	7189
Moteur Chrysler 440 cid 375 hp		66-71	0,90	XR4	5858	XR4IX	7189
Moteur Chrysler 440 cid		72-79	1,00	XR4	5858	XR4IX	7189
OLDSMOBILE							
Moteur Oldsmobile 350 cid		71-74	1,00	XR4	5858	XR4IX	7189
Moteur Oldsmobile 350 cid 2-bbl / 4-bbl		68-70	1,00	XR4	5858	XR4IX	7189
Moteur Oldsmobile 455 cid		76-78	0,90	BP-4	2911	XR4IX	7189
Moteur Oldsmobile 455 cid 2-bbl		71-	0,90	BP-4	2911	XR4IX	7189
Moteur Oldsmobile 455 cid 4-bbl		70-71	1,00	XR4	5858	XR4IX	7189
Moteur Oldsmobile 455 cid 4-bbl		72-74	0,90	BP-4	2911	XR4IX	7189
Moteur Oldsmobile 455 cid Hi-Perf.		72-74	1,00	XR4	5858	XR4IX	7189
PONTIAC							
Moteur Pontiac 389 cid		60-67	1,00	XR4	5858	XR4IX	7189
Moteur Pontiac 400 cid		67-71	1,00	XR4	5858	XR4IX	7189
Moteur Pontiac 400 / 455 cid		72-74	0,70	BPR5FS	2423	UR5IX	7177
Moteur Pontiac 421 cid		63-66	1,00	XR4	5858	XR4IX	7189
Moteur Pontiac 428 cid		67-69	1,00	XR4	5858	XR4IX	7189
Moteur Pontiac 455 cid 2-bbl		71-	0,90	BP-4	2911	XR4IX	7189
Moteur Pontiac 455 cid 4-bbl		70-71	0,90	BP-4	2911	XR4IX	7189

BAUDOIN

CR, H4, LH, LK, LKL	-	0,60	B-6L	3212	-	-
LA, LO3, LO3H, LOL	-	0,50	B-4	3210	-	-
VL3, VL3F, VL3FT	-	0,50	B6S	3510	-	-

BERKELEY

CHEVROLET							
350 cid Chevrolet		76-90	0,90	YR5	7052	YR5IX	7516
FORD							
302 / 351 cid Ford - Ø14mm		74-90	0,90	UR5	2771	UR5IX	7177
302 / 351 cid Ford - Ø18mm		74-77	0,90	AR6FS	3323	-	-
460 cid Ford Big Block		76-90	0,90	UR5	2771	UR5IX	7177
GM							
454 cid GM Big Block		76-90	0,90	YR5	7052	YR5IX	7516
OLDSMOBILE							
455 cid Oldsmobile		68-76	1,00	XR4	5858	XR4IX	7189

BMW

B 130 / 130S / 190 / 1901 / 190S / 220 / 2201 / 220S	-	0,60	BP5ES	6511	BPR5EIX	6597
G 1301 / 130S / 1901 / 190S / 2201 / 220S	-	0,60	BP5ES	6511	BPR5EIX	6597

BOMBARDIER (Sea-Doo)

Modèle

Cyl.

 N°
STOCK

 N°
STOCK IX

BOMBARDIER (Sea-Doo)

ROTAX						
Challenger Rotax 787 cc	-	0,60	BR8ES	5422	BR8EIX	5044
Explorer / Sportster Rotax 717cc	-	0,60	BR8ES	5422	BR8EIX	5044
Speedster Rotax 717cc	-	0,50	BR8ES	5422	BR8EIX	5044
947 CC						
Sportster LE DI	-	0,90	ZFR4F-11	4043	-	-
1494 CC						
150 Speedster	07-09	0,70	DCPR8E	4339	DCPR8EIX	6546
180 Challenger CS	05-09	0,70	DCPR8E	4339	DCPR8EIX	6546
200 Speedster / Twin 4-Tec	06-09	0,70	DCPR8E	4339	DCPR8EIX	6546
205 Utopia	08-09	0,70	DCPR8E	4339	DCPR8EIX	6546
210 Challenger	10-11	0,70	DCPR8E	4339	DCPR8EIX	6546
210 SP	11-	0,70	DCPR8E	4339	DCPR8EIX	6546
210 Wake	10-11	0,70	DCPR8E	4339	DCPR8EIX	6546
230 Challenger	07-09	0,70	DCPR8E	4339	DCPR8EIX	6546
230 Wake	08-09	0,70	DCPR8E	4339	DCPR8EIX	6546
Challenger CS	06-06	0,70	DCPR8E	4339	DCPR8EIX	6546
Islandia 220	06-07	0,70	DCPR8E	4339	DCPR8EIX	6546
Islandia SE	08-09	0,70	DCPR8E	4339	DCPR8EIX	6546
Speedster Wake	07-09	0,70	DCPR8E	4339	DCPR8EIX	6546
Sportster 4-Tec	06-	0,70	DCPR8E	4339	DCPR8EIX	6546
Sportster LE DI	06-	0,90	ZFR4F-11	4043	-	-
Utopia 205	06-07	0,70	DCPR8E	4339	DCPR8EIX	6546

BRIT. SEAGULL

ST110 1494cc	79-81	0,90	AB-6	2910	-	-
--------------	-------	------	------	------	---	---

CHEVROLET (MARINE CONVERSIONS)

194 / 230 / 250 cid	6	62-69	0,90	BPR5ES	7422	BPR5EIX	6597
230 cid	6	70-	1,10	UR4	6630	UR4IX	7401
250 cid	6	79-84	1,10	UR4	6630	UR4IX	7401
283 cid	8	55-67	1,00	XR4	5858	XR4IX	7189
292 cid	6	63-69	1,10	UR4	6630	UR4IX	7401
292 cid	6	70-78	0,70	BPR5FS	2423	UR5IX	7177
302 cid	8	67-69	0,90	XR4	5858	XR4IX	7189
307 cid	8	68-70	0,90	XR4	5858	XR4IX	7189
307 cid	8	71-73	0,70	BPR5FS	2423	UR5IX	7177
327 cid	8	61-69	0,90	XR5	3332	XR5IX	7355
350 cid	8	71-90	1,10	UR4	6630	UR4IX	7401
350 cid 2-bbl	8	67-70	1,00	XR4	5858	XR4IX	7189
350 cid 4-bbl	8	70-	1,00	XR4	5858	XR4IX	7189
400 cid	8	70-	1,00	XR4	5858	XR4IX	7189
400 cid	8	71-90	1,10	UR4	6630	UR4IX	7401
427 cid	8	71-72	0,70	UR6	7773	UR6IX	7348
427 cid	8	73-90	1,10	UR4	6630	UR4IX	7401
454 cid	8	79-90	0,80	UR5	2771	UR5IX	7177





CHRIS-CRAFT (Voir aussi VOLVO PENTA)

153	-	0,90	BR6ES	4922	-	-
181 (->603191)	-	0,90	BR6ES	4922	-	-
181 (603192->)	-	0,90	BPR6FS	2623	UR6IX	7348
225	-	0,90	BP6S	3111	-	-
283, 302, 307, 327 (Culasse plate)	-	0,60	B6S	3510	-	-
307, 350, 454 (Siège conique)	-	0,60	BPR6FS	2623	UR6IX	7348
350 Hi-Perf.	-	0,90	BR6FS	4323	BR6FIX	2318
427, 431 Series	-	0,80	A6FS	2210	-	-
430 Series	-	0,80	AP6FS	2710	-	-

CHRYSLER

4 CYLINDRES							
M 91D / 91F	4	-	0,90	BP6ES	7811	BPR6EIX	6637
M 122A / 112B	4	-	0,90	B7HS	5110	BR7HIX	7067
6 CYLINDRES							
B 46-4 / 46S-3	6	-	0,90	BR6S	3522	-	-
M 46-3 / 46-4 / 46S-3 / 47-3 / 47-4 / 47S-3	6	-	0,90	BR6S	3522	-	-
M 170 / 225A / 225GD	6	-	0,90	BR6ES	4922	-	-
M183B	6	-	0,90	B7HS	5110	BR7HIX	7067
M225D	6	-	0,90	BR6ES	4922	-	-
M225D	6	-74	0,90	BR6ES	4922	-	-
M225D	6	75-79	0,90	BPR6FS	2623	UR6IX	7348
M 265 / 265A	6	-	0,90	BR6S	3522	-	-
MH225D	6	-	0,90	BR6ES	4922	-	-
8 CYLINDRES							
LM318 A / AC / B / BC / BJ / BT / BV / D	8	-	0,90	BPR6ES	7822	BPR6EIX	6637

CHRYSLER

 Modèle	Cyl.				N° STOCK		N° STOCK IX
LM340 B / BJ / BT / BV	8	-	0,90	BPR6ES	7822	BPR6EIX	6637
M 44 / 44-3	8	-	0,90	BR6S	3522	-	-
M 45 / 45-3 / 45S / 45-S3 / 45-SP3 / 81	8	-	0,90	BR6ES	4922	-	-
M80	8	-	0,90	XR5	3332	XR5IX	7355
M273 A / B / BT	8	-	0,90	BPR6ES	7822	BPR6EIX	6637
M318 A / B / C / GD	8	-	0,90	XR5	3332	XR5IX	7355
M360 A / B / BC / BJ / BT / BV	8	-	0,90	BPR6ES	7822	BPR6EIX	6637
M383 B / BV, M400 B / BV / S, M413 B / D	8	-	0,90	XR5	3332	XR5IX	7355
M413E	8	-	0,90	BR6ES	4922	-	-
M426 B / D / Ski, M440 B / BJ / BV / D / S / SV	8	-	0,90	XR5	3332	XR5IX	7355
M460B	8	-	0,90	UR5	2771	UR5IX	7177

CHRYSLER-VOLVO

110 / 115 / 120 / 130 / 165 / 170	-	0,70	BR7HS	4122	BR7HIX	7067
-----------------------------------	---	------	-------	------	--------	------

CLAE

Bantam 3 / 4 hp	-	0,80	AB-6	2910	-	-
Fisherman Six 5 / 6 hp	-	0,80	AB-6	2910	-	-
Fisherman Ten 10 / 12 hp	-	0,80	AB-6	2910	-	-
C35, C35A	-	0,80	B6S	3510	-	-
Falcon Conversion	-	0,80	AP5FS	2610	WR5IX	7510
Holden 25/50 - Culot court	-	0,80	BP5S	3011	XR5IX	7355
Holden Conversion - Culot long	-	0,60	BP5ES	6511	BPR5EIX	6597
Valiant Conversion	-	0,80	B6ES	7310	-	-

CLIMAX

98 cid	-	0,80	BPR6ES	7822	BPR6EIX	6637
302 / 351 cid	-	0,80	A6FS	2210	-	-
460 cid	-	0,80	APR6FS	2922	-	-

CRUSADER

200 cid	79-79	0,90	BPR6FS	2623	UR6IX	7348
229 cid - 165	79-80	0,90	BPR6FS	2623	UR6IX	7348
229 cid - CH185	81-84	0,90	BPR6FS	2623	UR6IX	7348
262 cid	85-98	0,90	BPR6FS	2623	UR6IX	7348
292 cid - 185	71-80	0,90	R5674-7	3535	-	-
302 cid	74-75	0,80	AR6FS	3323	-	-
305 cid - 190 / 220	76-96	0,90	BPR6FS	2623	UR6IX	7348
307 cid - 210	71-80	0,90	R5674-7	3535	-	-
350 cid - 270	71-98	0,90	BPR6FS	2623	UR6IX	7348
351 cid - 255	74-75	0,80	AR6FS	3323	-	-
427 cid - 427	68-80	0,90	R5674-7	3535	-	-
454 cid - 350	72-80	0,90	BPR6FS	2623	UR6IX	7348
454 cid - 454	81-98	0,90	BPR6FS	2623	UR6IX	7348
460 cid - 350	74-75	0,90	BPR6FS	2623	UR6IX	7348
502 cid	89-98	0,90	BPR6FS	2623	UR6IX	7348

BOAT BUILDER

170J / 185 / 190 / 200J / 210 / 220 / 230 / 230J / 250	-	0,60	B6S	3510	-	-
280 - 9,9 hp	-	0,90	BR6ES	4922	-	-
CS 100 / 150 / 165 / 280 / 320	-	0,80	B6ES	7310	-	-
CS 180 / 220 / 250	-	0,80	B6S	3510	-	-

CHAMPION

305 / 350 / 454 cid	-	0,90	BPR6FS	2623	UR6IX	7348
350 cid HT	-	0,90	BPR6FS	2623	UR6IX	7348

CHARGER

CS 185 / 220 / 250	-	0,60	B6S	3510	-	-
CS 280	-	0,90	B6ES	7310	-	-
CS 320	-	0,80	B6ES	7310	-	-

CLASSIC

5.7L Plus EFI / MPI	-	1,10	TR5	2238	TR5IX	7397
7.4L HO MPI	-	1,10	BR6FS	4323	BR6FIX	2318
7.4L MPI	-	1,10	TR5	2238	TR5IX	7397
8.2L MPI	-	1,10	BR6FS	4323	BR6FIX	2318

GM

220 hp GM V8 5.7L MP	8	05-	1,50	TR55	3951	TR55IX	7164
275 hp GM V8 5.0L MP	8	05-	1,50	TR55	3951	TR55IX	7164
300 hp GM V8 5.7L CARB	8	-	1,50	TR55	3951	TR55IX	7164
375 hp GM V8 6.0L MP	8	-	1,50	TR55	3951	TR55IX	7164
385 hp GM V8 8.1L MP	8	-	1,50	TR55	3951	TR55IX	7164
425 hp GM V8 8.1L MP (HO)	8	-	1,50	TR55	3951	TR55IX	7164

MARK

Mark 140 / 170 / 170J / 185	-	0,60	B6S	3510	-	-
Mark 200 / 200J / 210 / 225 / 230 / 230J	-	0,60	B6S	3510	-	-
Mark 240 / 280	-	0,80	B6ES	7310	-	-
Mark 275 / 300 / 325	-	0,80	B8S	3810	-	-

CRUSADER



Modèle

Cyl.



N°
STOCK



N°
STOCK IX

PLATINUM

5.7L Plus MPI	-	1,10	TR5	2238	TR5IX	7397
7.4L HO MPI	-	1,10	BR6FS	4323	BR6FIX	2318
7.4L MPI	-	1,10	TR5	2238	TR5IX	7397
8.2L MPI	-	1,10	BR6FS	4323	BR6FIX	2318
XL/XLI						
262 / 305 / 350 / 454 / 454 HO / 502 cid	-	0,90	BPR6FS	2623	UR6IX	7348

CUYUNA

430LC 40 hp Jet Drive	-	0,80	BR8ES	5422	BR8EIX	5044
-----------------------	---	------	-------	------	--------	------

DAIMLER

SP 250	-	0,70	BR6ES	4922	-	-
--------	---	------	-------	------	---	---

DAYTONA

100 / 150	-	0,90	B6ES	7310	-	-
200 / 300	-	0,90	B6S	3510	-	-
400 / 400 Turbo	-	0,90	B7ES	1111	BR7EIX	6664
427 / 427 Turbo heavy Service	-	0,90	B8ES	2411	BR8EIX	5044
427 / 427 Turbo light Service	-	0,90	B7ES	1111	BR7EIX	6664

DIESEL-TECHNIK

DTR 40 / 50	-	0,60	BP6HS	4511	BPR6HIX	4085
-------------	---	------	-------	------	---------	------

DYNAFOIL

G440-BW (432cc) Moteur Xenoah	-	0,90	BR6ES	4922	-	-
-------------------------------	---	------	-------	------	---	---

EVINRUDE

CU / SU 153 cid 110 / 120 hp	-	0,90	BR6ES	4922	-	-
DU 89 cid 88 / 90 hp	-	0,80	B6S	3510	-	-
HU 225 cid 150 / 155 hp	-	0,90	BP5S	3011	XR5IX	7355
KU 283 cid 185 hp	-	0,90	B6S	3510	-	-
NU 1600cc 89 / 90 hp	-	0,60	BP6ES	7811	BPR6EIX	6637
TU 14/15/16 300 cid 200 hp	-	0,90	XR4	5858	XR4IX	7189
TU 17->283, 307 cid 210 hp	-	0,90	XR4	5858	XR4IX	7189

FAGEOL

44 / 53	-	0,60	B6S	3510	-	-
FM 200 / 225	-	0,50	B6S	3510	-	-

FLAGSHIP

181 cid - 181FL	75-77	0,90	YR5	7052	YR5IX	7516
280 cid - 280E	75-77	0,90	R5674-7	3535	-	-
292 cid	71-74	0,90	UR5	2771	UR5IX	7177
292 cid - 155	-	0,90	B6ES	7310	-	-
300 cid - Heavy Service	77-	1,10	R5674-7	3535	-	-
300 cid - Light Service	77-	1,10	UR5	2771	UR5IX	7177
305 / 307 / 350 cid	71-74	0,90	UR5	2771	UR5IX	7177
305 cid - Heavy Service	75-93	1,10	R5674-7	3535	-	-
305 cid - Light Service	75-77	1,10	UR5	2771	UR5IX	7177
350 CID HI PERFORMANCE						
295FAS / 335	75-93	0,90	R5674-7	3535	-	-
350 cid - Heavy Service	75-93	1,10	R5674-7	3535	-	-
380FAS / TC400	75-93	0,90	R5674-7	3535	-	-
TC500	75-93	0,90	R5673-8	4140	-	-
427 CID						
300	71-74	0,90	B7ES	1111	BR7EIX	6664
454 CID						
454 cid	71-74	0,90	UR5	2771	UR5IX	7177
Heavy Service	75-93	1,10	R5674-7	3535	-	-
Light Service	75-77	1,10	UR5	2771	UR5IX	7177
454 CID HI PERFORMANCE						
400 FAJ / FAS	75-77	0,90	R5674-7	3535	-	-
450 FAJ / FAS	75-93	0,90	R5674-7	3535	-	-
460 FAJ / FAS, 500FAJ	75-77	0,90	R5674-7	3535	-	-
TC500	75-93	0,90	R5673-8	4140	-	-
TC550	75-93	0,90	R5674-7	3535	-	-
TC650	75-77	0,90	R5673-8	4140	-	-
466 CID HI PERFORMANCE						
675 FAJ / FAS (Utilisation normale)	75-81	0,90	R5674-7	3535	-	-
490 CID HI PERFORMANCE						
500 FAJ / FAS	75-81	0,90	R5674-7	3535	-	-



Modèle

Cyl.



N° STOCK



N° STOCK IX

FORD

Ø18mm - Culasse plate	-	0,80	AB-6	2910	-	-
Moteur à soupapes latérales	4	0,80	B6HS	4510	BR6HIX	3419
67 / 98 cid	-	0,90	GR5	2851	GR5IX	7214
104 cid	-	0,70	GR4	2635	GR4IX	7149
105-E / 109-E Anglia OHV	-	0,80	B5ES	6410	-	-
112E / 115E / 125E	-	0,80	B5ES	6410	-	-
144 cid - Falcon conversion	6	0,90	AP5FS	2610	WR5IX	7510
158 cid	-	0,90	BR6ES	4922	-	-
172 cid	-	0,70	B-6L	3212	-	-
201 cid	-	0,90	BR6ES	4922	-	-
250 cid	-	0,80	AR6FS	3323	-	-
272 / 292 cid OHV	8	0,80	AP6FS	2710	-	-
312 cid	-	0,80	AP6FS	2710	-	-
427 cid	75-89	0,70	UR5	2771	UR5IX	7177
427 cid 302 / 351W	-74	0,90	WR5	2438	WR5IX	7510
429 cid	75-89	0,70	UR5	2771	UR5IX	7177
460 cid 302 / 351W	75-89	0,80	UR5	2771	UR5IX	7177
477 cid	76-	0,80	AR6FS	3323	-	-
534 cid	76-	0,80	AR6FS	3323	-	-
3004E	-	0,80	B5ES	6410	-	-
Consul	-	0,80	BP5ES	6511	BPR5EIX	6597
V8 - Soupapes latérales (Mercury, Customs)	-	0,80	B-6L	3212	-	-
Zephyr	-	0,80	BP5ES	6511	BPR5EIX	6597

GOFF

GMP 225	69-73	0,90	XR4	5858	XR4IX	7189
GMP 455	61-	0,80	XR4	5858	XR4IX	7189

GOTA

5-6, 10-12, 15-18	-	0,50	AB-6	2910	-	-
SLF10, SL3, SL6, SL12	-	0,50	AB-6	2910	-	-

GRAYMARINE

EXPRESS

Four 52 / 112 / 140 / 162	-	0,70	AB-6	2910	-	-
Seascout 91	-	0,90	BR6S	3522	-	-
Six 71 / 77 / 80 / 91 / 111 / 121 / 186 / 224 / 427	-	0,70	AB-6	2910	-	-
Super 117 / 427	-	0,70	AB-6	2910	-	-

FIREBALL

135 / 138 / 138A / 170 / 175 / 178 / 178B / 188 / 195	-	0,70	XR5	3332	XR5IX	7355
215 / 220 / 225 / 238 / 260 / 280 / 310 / 427	-	0,70	XR5	3332	XR5IX	7355
304 / 360	-	0,70	GR4	2635	GR4IX	7149
C, CF, CH	-	0,70	XR5	3332	XR5IX	7355
Four 50	-	0,90	BR6S	3522	-	-
Four 90, Six 116 / 140 / 150 / 160, Super 330	-	0,70	AB-6	2910	-	-
Six 232 Stern Drive	-	0,90	GR5	2851	GR5IX	7214

LUGGER

Four 22 / 52 / 112	-	0,70	AB-7	3010	-	-
Four 40 / 75 / 80 / 85TD / 130 / 162	-	0,70	AB-6	2910	-	-
Four 69, Seascout 45 / 91	-	0,90	BR6S	3522	-	-
Six 51 / 121 / 186 / 226 / 330	-	0,70	AB-7	3010	-	-
Six 71 / 77 / 91 / 244	-	0,70	AB-6	2910	-	-

PHANTOM

Four 45	-	0,90	BR6S	3522	-	-
Four 62 / 75 / 85 / 86 / 162 / 620	-	0,70	AB-6	2910	-	-
Six 70, 80, 88, 90, 100, 103, 104, 109, 109TD, 110	-	0,70	AB-6	2910	-	-
Six 115	-	0,70	AB-8	7909	-	-
Six 116 / 118 / 120 / 122 / 125	-	0,70	AB-6	2910	-	-
Six 135	-	0,70	AB-8	7909	-	-
Six 135	-	0,70	AB-6	2910	-	-
Six 136 / 150 / 165 / 175 / 185	-	0,70	AB-6	2910	-	-
Six 200	-	0,70	AB-8	7909	-	-

GUARDIAN MARINE

CHEVROLET

454 cid	-	1,10	UR4	6630	UR4IX	7401
---------	---	------	-----	------	-------	------

FORD

302 / 351W / 460 cid	-	0,90	UR5	2771	UR5IX	7177
----------------------	---	------	-----	------	-------	------





OLDSMOBILE

455 cid	-	0,90	XR4	5858	XR4IX	7189
---------	---	------	-----	------	-------	------

HARDIN

H225 IO / J / V	80-86	0,90	YR5	7052	YR5IX	7516
H240J	69-90	0,90	XR5	3332	XR5IX	7355
H240J (Siège conique)	69-90	0,90	UR5	2771	UR5IX	7177

HARDIN

Modèle	Cyl.				N° STOCK		N° STOCK IX
H240V		69-90	0,90	XR5	3332	XR5IX	7355
H240V (Siège conique)		69-90	0,90	UR5	2771	UR5IX	7177
H260 IO / J / V		80-86	0,90	YR5	7052	YR5IX	7516
H280, H280 J / V		80-86	0,90	YR5	7052	YR5IX	7516
H295 J / V		60-76	0,90	XR5	3332	XR5IX	7355
H300 J / V		77-90	0,90	XR5	3332	XR5IX	7355
H305I, H320 J / V		79-90	0,90	YR5	7052	YR5IX	7516
H324 J / V		75-76	0,90	XR5	3332	XR5IX	7355
H325 J / V		69-76	0,80	XR5	3332	XR5IX	7355
H333 J / V		76-90	0,90	YR5	7052	YR5IX	7516
H345 J / V		69-76	0,80	XR5	3332	XR5IX	7355
H350I		79-90	0,90	YR5	7052	YR5IX	7516
H405 J / V		74-90	0,90	YR5	7052	YR5IX	7516
H405TC		78-90	0,70	B7HS	5110	BR7HIX	7067
H454I		79-90	0,90	YR5	7052	YR5IX	7516
H455J (ET)		76-	0,90	XR5	3332	XR5IX	7355
H455V (ET)		76-	0,90	XR5	3332	XR5IX	7355
HM 225 / 260 / 280 / 333 / 400 / 405 / 430		83-90	0,90	UR5	2771	UR5IX	7177

HOLDEN

Tous modèles culasse plate (culot court)	-	0,80	BP5S	3011	XR5IX	7355
Tous modèles culasse plate (culot long)	-	0,90	BP6ES	7811	BPR6EIX	6637
Tous modèles siège conique (culot court)	-	0,90	BP6FS	3512	UR6IX	7348
Tous modèles siège conique (culot long)	-	0,90	BP6EFS	3812	TR6IX	3689

INDMAR

CADILLAC

4.6L MPI Northstar - 279 cid	-	1,50	TR55	3951	TR55IX	7164
------------------------------	---	------	------	------	--------	------

FORD

5.0L V8 200 - 302 cid	8	91-95	1,10	UR5	2771	UR5IX	7177
5.0L V8 225 - 302 cid	8	91-97	0,90	UR5	2771	UR5IX	7177
5.8L V8 - 351 cid	8	83-87	0,90	AR6FS	3323	-	-
5.8L V8 250 - 351 cid	8	91-97	0,90	UR5	2771	UR5IX	7177
5.8L V8 285 H.O. - 351 cid	8	91-97	1,10	BPR6EFS	3623	TR6IX	3689
7.5L V8 - 460 cid	8	76-84	0,90	UR5	2771	UR5IX	7177

GM

3.0L	4	-	0,90	BR6FS	4323	BR6FIX	2318
4.3L V6 EFI	6	-	1,10	BR6FS	4323	BR6FIX	2318
5.0L V8 230 / 230SP - Small Block	8	-	1,10	BR6FS	4323	BR6FIX	2318
5.7L LS1 Corvette - Small Block	8	-	0,90	TR4	3754	TR4IX	7300
5.7L V8 - Small Block	8	76-87	1,00	UR5	2771	UR5IX	7177
5.7L V8 Carb / EFI - Small Block	8	-	1,10	BR6FS	4323	BR6FIX	2318
5.7L V8 Carb / EFI H.O. - Small Block	8	-	1,10	BPR6EFS	3623	TR6IX	3689
5.7L V8 Except LS1 - Small Block	8	94-05	1,00	TR5	2238	TR5IX	7397
5.7L V8 Gen 1+ Carb - Small Block	8	-	1,10	BPR6EFS	3623	TR6IX	3689
5.7L V8 Gen 1+ H.O. Carb - Small Block	8	-	1,10	BPR6EFS	3623	TR6IX	3689
5.7L V8 Gen 1+ H.O. PFI - Small Block	8	-	1,10	BPR6EFS	3623	TR6IX	3689
5.7L V8 Indmar TBI - Small Block	8	-	1,10	BR6FS	4323	BR6FIX	2318
5.7L V8 LS1 - Small Block	8	94-02	1,20	TR55	3951	TR55IX	7164
5.7L V8 LS1 - Small Block	8	03-05	1,50	TR55	3951	TR55IX	7164
5.7L V8 LT-1 - Small Block	8	-	1,10	BPR6EFS	3623	TR6IX	3689
6.0L V8 - GM Big Block	8	03-05	1,50	TR55	3951	TR55IX	7164
6.6L V8 - Small Block	8	-	1,10	BR6FS	4323	BR6FIX	2318
7.4L V8 - GM Big Block	8	98-99	1,10	BPR6EFS	3623	TR6IX	3689
7.4L V8 - GM Big Block	8	03-05	1,10	TR5	2238	TR5IX	7397
7.4L V8 Carb / EFI - GM Big Block	8	-97	1,10	BR6FS	4323	BR6FIX	2318
7.4L V8 Carb / EFI H.O. - GM Big Block	8	-97	1,10	BR6FS	4323	BR6FIX	2318
7.4L V8 H.O. - GM Big Block	8	-97	1,10	BPR6EFS	3623	TR6IX	3689
8.1L MPI Vortec - GM Big Block	8	03-05	1,50	TR55	3951	TR55IX	7164
8.2L V8 - GM Big Block	8	-97	1,10	BR6FS	4323	BR6FIX	2318
8.2L V8 - GM Big Block	8	98-99	1,10	BPR6EFS	3623	TR6IX	3689
8.2L V8 - GM Big Block	8	03-05	1,10	TR5	2238	TR5IX	7397
8.2L V8 H.O. - GM Big Block	8	-97	1,10	BR6FS	4323	BR6FIX	2318

OLDSMOBILE

350 cid 5.7L V8	8	76-82	1,00	XR4	5858	XR4IX	7189
403 cid 6.6L V8	8	76-82	1,00	XR4	5858	XR4IX	7189
455 cid 7.5L V8	8	75-76	1,00	XR4	5858	XR4IX	7189

INTERCEPTOR

104 V4	4	-	0,80	BP7HS	5111	BPR7HIX	5944
122 V6	6	-	0,80	BP7HS	5111	BPR7HIX	5944
144 / 270	-	-	0,80	AP5FS	2610	WR5IX	7510
144 (Utilisation à régime élevé)	-	-	0,80	AP6FS	2710	-	-
170 / 200 / 256 / 272 / 289 / 292 / 312 / 352	-	-	0,80	A6FS	2210	-	-
260	-	-	0,80	AP7FS	2127	-	-
302 / 390	-	-	0,80	AP6FS	2710	-	-
427 - 300 hp	-	-	0,80	A6FS	2210	-	-
427 - 400 hp	-	-	0,80	AP6FS	2710	-	-



Modèle

Cyl.

N°
STOCKN°
STOCK IX

JOHNSON

SERIE CU / SU

153 cid - 110 & 120 hp	-	0,90	B6ES	7310	-	-
------------------------	---	------	------	------	---	---

SERIE DU

89 cid - 89 & 90 hp	-	0,80	B8S	3810	-	-
---------------------	---	------	-----	------	---	---

SERIE HU

225 cid - 150 & 155 hp	-	0,90	BP6S	3111	-	-
------------------------	---	------	------	------	---	---

SERIE KU

185 hp - 283 cid	-	0,90	B6S	3510	-	-
------------------	---	------	-----	------	---	---

SERIE NU

1600cc - 80 & 90hp	-	0,80	BP6ES	7811	BPR6EIX	6637
--------------------	---	------	-------	------	---------	------

KODIAK

3.0L L4 140 hp - 181 cid		99-00	1,10	UR4	6630	UR4IX	7401
4.3L V6 220 hp - 262 cid	6	99-00	1,10	BR6FS	4323	BR6FIX	2318
5.7L V8 310 hp - 350 cid	8	99-00	1,10	TR5	2238	TR5IX	7397
7.4L V8 350 hp - 454 cid	8	99-00	1,10	BR6FS	4323	BR6FIX	2318

MARINE DRIVE SYSTEMS

85 / 110 Stern Drive	-	0,60	BP7HS	5111	BPR7HIX	5944
----------------------	---	------	-------	------	---------	------

MARINE POWER

L4

181 cid 3.0L	4	75-78	0,90	BR6ES	4922	-	-
181 cid 3.0L Siège conique	4	75-91	0,90	BR6FS	4323	BR6FIX	2318
181 cid 3.0L Siège conique	4	92-00	0,90	BPR6EFS	3623	TR6IX	3689

MOTEUR GM

V6 262 cid 4.3L	6	95-97	0,90	BR6FS	4323	BR6FIX	2318
V6 262 cid 4.3L	6	98-00	0,90	TR5	2238	TR5IX	7397
V8 305 cid 5.0L - GM Small Block	8	00-	0,90	TR5	2238	TR5IX	7397
V8 305 cid 5.0L G, K, LV - GM Small Block	8	77-86	0,90	BR6FS	4323	BR6FIX	2318
V8 307 cid 5.0L G, K, LV 215 hp - GM Small Block	8	75-76	0,90	BR6FS	4323	BR6FIX	2318
V8 350 cid 5.7L - GM Small Block	8	92-97	0,90	BR6FS	4323	BR6FIX	2318
V8 350 cid 5.7L - GM Small Block	8	98-00	0,90	TR5	2238	TR5IX	7397
V8 350 cid 5.7L FLV 300 hp - GM Small Block	8	75-86	0,90	BR6FS	4323	BR6FIX	2318
V8 350 cid 5.7L FLV, GLV, K 250 hp - GM Small Block	8	75-86	0,90	BR6FS	4323	BR6FIX	2318
V8 350 cid 5.7L Premium - GM Small Block	8	92-97	0,90	BPR6EFS	3623	TR6IX	3689
V8 350 cid 5.7L Q Series - GM Small Block	8	79-91	0,90	BR6FS	4323	BR6FIX	2318
V8 454 cid 7.4L - GM Big Block	8	92-97	0,90	BR6FS	4323	BR6FIX	2318
V8 454 cid 7.4L - GM Big Block	8	98-00	0,90	BR6FS	4323	BR6FIX	2318
V8 454 cid 7.4L (L29) - GM Big Block	8	00-	0,90	BPR6EFS	3623	TR6IX	3689
V8 454 cid 7.4L B, BM 330 hp - GM Big Block	8	75-91	0,90	BR6FS	4323	BR6FIX	2318
V8 454 cid 7.4L Premium - GM Big Block	8	92-97	0,90	BR6FS	4323	BR6FIX	2318
V8 502 cid 8.2L - GM Big Block	8	95-97	0,90	BR6FS	4323	BR6FIX	2318
V8 502 cid 8.2L Premium - GM Big Block	8	95-97	0,90	BR6FS	4323	BR6FIX	2318
V8 540 cid 8.9L 550 hp - GM Big Block	8	95-97	0,90	BR6FS	4323	BR6FIX	2318

MARINETEK

CHRYSLER

318 cid		66-74	1,00	XR4	5858	XR4IX	7189
318 / 360 cid		75-88	0,90	BPR5ES	7422	BPR5EIX	6597

FORD

302 cid		68-74	0,90	WR5	2438	WR5IX	7510
302 cid		75-80	0,90	UR5	2771	UR5IX	7177
302 cid		81-95	1,10	UR4	6630	UR4IX	7401
351 cid		69-74	0,90	WR5	2438	WR5IX	7510
351 cid		75-87	0,90	UR5	2771	UR5IX	7177
460 cid		73-74	0,90	WR5	2438	WR5IX	7510
460 cid		75-87	0,90	UR5	2771	UR5IX	7177





GM





181 cid 3.0L HO		90-97	1,10	TR4	3754	TR4IX	7300
229 cid		80-84	1,10	UR4	6630	UR4IX	7401
250 cid		70-80	1,10	UR4	6630	UR4IX	7401
262 cid		85-92	1,10	UR4	6630	UR4IX	7401
305 cid		76-95	1,10	UR4	6630	UR4IX	7401
350 cid		67-70	1,00	XR4	5858	XR4IX	7189
350 cid		71-95	1,10	UR4	6630	UR4IX	7401
350 cid HO		87-95	0,90	UR5	2771	UR5IX	7177
454 cid		73-87	1,10	UR4	6630	UR4IX	7401
454 cid Gen V		92-93	0,90	UR5	2771	UR5IX	7177
454 cid HO		84-91	0,90	UR5	2771	UR5IX	7177

MERCUISER

FORD

215 / 225	8	-	0,80	AR6FS	3323	-	-
233 - Ø14mm	8	-	0,80	BPR6FS	2623	UR6IX	7348
233 - Ø18mm	8	-	0,80	AR6FS	3323	-	-

	Modèle	Cyl.				N° STOCK		N° STOCK IX
233 MCM & MIE (350 cid)		8	75-77	0,80	AR6FS	3323	-	-
255		8	-	0,90	BR6FS	4323	BR6FIX	2318
255 MCM & MIE (350 cid)		8	73-80	0,80	AR6FS	3323	-	-
GM - BIG BLOCK								
325 (-> N°2762441)		8	-	-	BUE	2322	-	-
325 (N°2762442->)		8	-	0,90	R5673-8	4140	-	-
330 (454 cid)		8	82-87	0,90	BR6FS	4323	BR6FIX	2318
330 MCM & MIE (454 cid)		8	77-81	0,90	BR6FS	4323	BR6FIX	2318
330 MCM & MIE (454 cid)		8	77-81	0,90	R5673-8	4140	-	-
340		8	-	0,90	BR6FS	4323	BR6FIX	2318
340 MIE (454 cid)		8	81-87	0,90	BR6FS	4323	BR6FIX	2318
350		8	-	0,90	R5673-8	4140	-	-
350 MIE (454 cid)		8	74-76	0,90	R5673-8	4140	-	-
390		8	-	0,90	BPR8ES	3923	BPR8EIX	6684
400 Jet		8	-	0,90	BR6FS	4323	BR6FIX	2318
454 EFI MP		8	-	1,00	BR6FS	4323	BR6FIX	2318
454 Mag MPI (N°0L002200->)		8	-	0,90	BR6FS	4323	BR6FIX	2318
454 MPI		8	-	1,00	BR6FS	4323	BR6FIX	2318
7.4L / 7.4L EFI / 7.4L MPI		8	-	1,00	BR6FS	4323	BR6FIX	2318
7.4L MPI (->N°0L000000)		8	-	1,00	BR6FS	4323	BR6FIX	2318
7.4L MPI (N°0L002006->)		8	-	1,10	BPR6EFS	3623	TR6IX	3689
8.1S HO / Horizon		8	00-06	1,50	TR55	3951	TR55IX	7164
8.1S HO / Horizon		8	07-	0,80	IZFR7M	4214	-	-
8.2L / 8.2L MPI		8	-	1,00	BR6FS	4323	BR6FIX	2318
GM - SMALL BLOCK								
198 / 228 / 230		8	-	0,90	YR5	7052	YR5IX	7516
225		8	-	0,80	B7S	3710	-	-
250 (N°2317201 ->N°2797056)		8	-	1,00	B7S	3710	-	-
255 / 260		8	-	0,90	BR6FS	4323	BR6FIX	2318
270		8	-	0,90	B7S	3710	-	-
270 - siège conique		8	-	0,90	R5673-8	4140	-	-
350 Mag		8	-	1,00	BR6FS	4323	BR6FIX	2318
350 Mag Alpha		8	86-97	0,90	BR6FS	4323	BR6FIX	2318
350 Mag Alpha EFI (Gen+)		8	-	1,10	-	-	TR5IX	7397
350 Mag Bravo MPI		8	-	0,90	BR6FS	4323	BR6FIX	2318
350 Mag Bravo MPI (Gen+)		8	96-97	1,10	-	-	TR5IX	7397
350 Mag EFI (->N°0F799999)		8	-	1,00	BR6FS	4323	BR6FIX	2318
350 Mag EFI Gen+ (N°0F800000->)		8	-	1,10	BPR6EFS	3623	TR6IX	3689
350 Mag EFI / MP (->N°0F799999)		8	-	1,00	BR6FS	4323	BR6FIX	2318
350 Mag EFI Ski		8	94-96	1,10	BPR6EFS	3623	TR6IX	3689
350 Mag EFI Ski (Gen+)		8	96-97	1,10	BPR6EFS	3623	TR6IX	3689
350 Mag MPI		8	02-	1,50	ITR4A15	5599	-	-
350 Mag MPI		8	07-	0,80	IZFR7M	4214	-	-
350 Mag MPI (N°0L304700->)		8	00-06	0,90	TR5	2238	TR5IX	7397
350 Mag MPI (->N°0F799999)		8	00-06	1,00	BR6FS	4323	BR6FIX	2318
350 Mag MPI EC		8	08-	1,50	ITR4A15	5599	-	-
350 Mag MPI Gen+ (0L002600-0L309999)		8	-	1,10	BPR6EFS	3623	TR6IX	3689
350 Mag MPI Gen+ (N°0M310000->)		8	-	1,50	TR55	3951	TR55IX	7164
350 Mag MPI Horizon		8	02-07	1,50	ITR4A15	5599	-	-
350 Mag MPI Horizon		8	07-	0,80	IZFR7M	4214	-	-
350 Mag MPI Horizon MIE		8	99-01	1,10	-	-	TR5IX	7397
350 Mag MPI Horizon MIE		8	02-07	1,50	ITR4A15	5599	-	-
350 Mag MPI MIE		8	02-07	1,50	ITR4A15	5599	-	-
350 Mag MPI MIE (Gen+)		8	98-01	1,10	-	-	TR5IX	7397
350 Mag MPI Ski		8	95-96	0,90	BR6FS	4323	BR6FIX	2318
350 Mag MPI Ski		8	01-04	1,50	-	-	TR55IX	7164
350 Mag MPI Ski (Gen+)		8	98-01	1,10	BPR6EFS	3623	TR6IX	3689
350 Mag Ski		8	91-97	0,90	BR6FS	4323	BR6FIX	2318
454 EFI / MP / MPI		8	-	1,00	BR6FS	4323	BR6FIX	2318
5.0L		8	-	0,90	YR5	7052	YR5IX	7516
5.0L MPI		8	-	1,00	BR6FS	4323	BR6FIX	2318
5.7L		8	88-97	1,00	BR6FS	4323	BR6FIX	2318
5.7L		8	07-	0,80	IZFR7M	4214	-	-
5.7L (->N°0L000000)		8	-	1,00	BR6FS	4323	BR6FIX	2318
5.7L Comp (->N°0L000000)		8	-	1,00	BR6FS	4323	BR6FIX	2318
5.7L Comp Gen+ (N°0L002005->)		8	-	1,10	BPR6EFS	3623	TR6IX	3689
5.7L EFI Gen+ (N°0L010035->)		8	-	1,10	BPR6EFS	3623	TR6IX	3689
5.7L Gen+ (N°0L010037->)		8	-	1,10	BPR6EFS	3623	TR6IX	3689
5.7L MIE		8	93-95	0,90	BR6FS	4323	BR6FIX	2318
5.7L MIE (Gen+)		8	98-	1,10	-	-	TR5IX	7397
5.7L MIE (LH / RH)		8	88-93	0,90	BR6FS	4323	BR6FIX	2318
5.7 MPI Horizon MIE / MPI MIE / MPI MIE EC		8	08-	1,50	ITR4A15	5599	-	-
5.7 MPI Tow Sports / Tow Sports EC		8	08-	1,50	ITR4A15	5599	-	-
5.7L Ski		8	85-97	0,90	BR6FS	4323	BR6FIX	2318
5.7L Ski		8	98-	1,10	-	-	TR5IX	7397
Black Scorpion 5.7L		8	07-	0,80	IZFR7M	4214	-	-
Black Scorpion 5.7L (N°0F80000->)		8	00-06	1,10	BPR6EFS	3623	TR6IX	3689
Black Scorpion 5.7L (N°0M391852->)		8	00-06	1,50	TR55	3951	TR55IX	7164
Black Scorpion Ski (Gen+)		8	96-02	1,10	-	-	TR5IX	7397
Black Scorpion Ski (Gen+)		8	03-07	1,50	ITR4A15	5599	-	-

 Modèle	Cyl.				N° STOCK		N° STOCK IX
Black Scorpion MX 6.2	8	00-06	0,90	TR5	2238	TR5IX	7397
Black Scorpion MX 6.2	8	07-	0,80	IZFR7M	4214	-	-
Black Scorpion MX 6.2 (N°0M391778->)	8	00-06	1,50	TR55	3951	TR55IX	7164
MX 6.2 MPI	8	07-	0,80	IZFR7M	4214	-	-
MX 6.2 MPI (->N°0M320614)	8	00-06	1,50	TR55	3951	TR55IX	7164
MX 6.2 MPI (N°M320613->)	8	00-06	1,10	BPR6EFS	3623	TR6IX	3689
MX 6.2 MPI Horizon (N°0M320614->)	8	00-06	1,50	TR55	3951	TR55IX	7164
MX 6.2 MPI Horizon (N°0M320614->)	8	07-	0,80	IZFR7M	4214	-	-
MX 6.2L MPI (377cid)	8	00-01	1,10	-	-	TR5IX	7397
MX 6.2L MPI (377cid)	8	02-07	1,50	ITR4A15	5599	-	-
MX 6.2L MPI Horizon (377cid)	8	02-07	1,50	ITR4A15	5599	-	-
MX 6.2L MPI Horizon MIE (377cid)	8	02-	1,50	ITR4A15	5599	-	-
MX 6.2L MPI MIE (377cid)	8	99-01	1,10	-	-	TR5IX	7397
MX 6.2L MPI MIE / MPI Ski (377cid)	8	02-07	1,50	ITR4A15	5599	-	-
MX 6.2L MPI MIE EC (377cid)	8	08-	1,50	ITR4A15	5599	-	-
Scorpion 350 / 350 EC	8	08-	1,50	ITR4A15	5599	-	-
Scorpion 377	8	-	1,10	BPR6EFS	3623	TR6IX	3689
Scorpion 377	8	08-	1,50	ITR4A15	5599	-	-
Scorpion 377 HO EC	8	09-	1,50	ITR4A15	5599	-	-
Scorpion 377 MCM	8	99-05	1,10	-	-	TR5IX	7397
Scorpion 377 Ski	8	97-98	1,10	-	-	TR5IX	7397
STERN DRIVE - CHEVROLET L-6							
140	6	-	0,90	BR6ES	4922	-	-
150	6	64-66	0,90	BR6ES	4922	-	-
GK	6	-	0,90	BR6ES	4922	-	-
160 - 250 cid	6	67-69	0,90	BR6ES	4922	-	-
165 (->N°2771483)	6	70-70	0,90	BR6ES	4922	-	-
165 (N°2771484->)	6	71-81	0,90	BR6FS	4323	BR6FIX	2318
200 - 292 cid	6	-	0,90	BR6ES	4922	-	-
STERN DRIVE - CHEVROLET V-6							
4.3L (->N°0F802999)	6	-	1,00	BR6FS	4323	BR6FIX	2318
4.3L EFI Gen+ (N°0L012009->)	6	-	1,10	BPR6EFS	3623	TR6IX	3689
4.3L Gen+ (N°0L010065->)	6	-	1,10	BPR6EFS	3623	TR6IX	3689
4.3L MPI Gen+ (N°0M322781->)	6	-	1,50	-	-	TR55IX	7164
4.3LH EFI Gen+ (N°0L010044->)	6	-	1,10	BPR6EFS	3623	TR6IX	3689
4.3LX (->N°0F001219)	6	88-93	0,90	BR6FS	4323	BR6FIX	2318
4.3LX (->N°0F802999)	6	93-96	1,00	BR6FS	4323	BR6FIX	2318
4.3LX Gen+ (N°0F803000 ->N°0L000000)	6	96-97	1,10	BPR6EFS	3623	TR6IX	3689
4.3LXH Gen+ (N°0F803000 ->N°0L000000)	6	96-97	1,10	BPR6EFS	3623	TR6IX	3689
175 - 262 cid	6	-	0,90	BR6FS	4323	BR6FIX	2318
185	6	-	0,90	BR6FS	4323	BR6FIX	2318
185 - 229 cid	6	-	0,90	BR6FS	4323	BR6FIX	2318
205 - 262 cid	6	85-87	0,90	BR6FS	4323	BR6FIX	2318
262 Mag EFI Gen+ (N°0F803800->N°0L000000)	6	-	1,10	BPR6EFS	3623	TR6IX	3689
STERN DRIVE - CHEVROLET BIG BLOCK							
7.4L Alpha	8	-	0,90	BR6FS	4323	BR6FIX	2318
7.4L Bravo	8	88-97	1,00	BR6FS	4323	BR6FIX	2318
7.4L EFI MIE	8	96-97	1,00	BR6FS	4323	BR6FIX	2318
7.4L MIE	8	81-97	0,90	BR6FS	4323	BR6FIX	2318
7.4L MPI (L29) (N°0L010003->)	8	98-01	1,10	BPR6EFS	3623	TR6IX	3689
7.4L MPI MIE	8	95-97	0,90	BR6FS	4323	BR6FIX	2318
7.4L MPI MIE (L29)	8	98-01	1,10	BPR6EFS	3623	TR6IX	3689
7.4LX Bravo EFI / MPI	8	96-97	0,90	BR6FS	4323	BR6FIX	2318
7.4LX EFI / MPI	8	-	1,00	BR6FS	4323	BR6FIX	2318
7.4L TR (N°0B771113 ->N°0C407646)	8	-	0,90	BR6FS	4323	BR6FIX	2318
330 / 330 (B-W) / 370	8	-	0,90	BR6FS	4323	BR6FIX	2318
390	8	-	0,90	BPR8ES	3923	BPR8EIX	6684
400 / 400 Cyclone / 420 / 440 Cyclone	8	-	0,90	BR6FS	4323	BR6FIX	2318
454 Mag Alpha	8	86-88	0,90	BR6FS	4323	BR6FIX	2318
454 Mag Bravo	8	88-97	1,00	BR6FS	4323	BR6FIX	2318
454 Mag EFI / MP	8	94-96	1,00	BR6FS	4323	BR6FIX	2318
454 Mag EFI Ski	8	95-96	0,90	BR6FS	4323	BR6FIX	2318
454 Mag MPI	8	96-01	1,00	BR6FS	4323	BR6FIX	2318
454 Mag MPI Horizon (N°0L604250->)	8	-	1,00	BR6FS	4323	BR6FIX	2318
454 Mag MPI Horizon MIE	8	98-01	1,00	-	-	BR6FIX	2318
454 Mag MPI Horizon Ski	8	96-97	1,00	BR6FS	4323	BR6FIX	2318
460 Cyclone / 475 Turbo	8	-	0,90	R5673-8	4140	-	-
460 TRS	8	83-86	0,90	R5673-8	4140	-	-
496 Mag / Mag HO	8	-	1,50	TR55	3951	TR55IX	7164
496 Mag & HO EC	8	08-	1,50	PZTR5A-15	7862	-	-
502 Mag	8	90-93	1,00	BR6FS	4323	BR6FIX	2318
502 Mag EFI/MP	8	93-96	1,00	BR6FS	4323	BR6FIX	2318
502 Mag MPI	8	96-01	1,00	BR6FS	4323	BR6FIX	2318
HP 425 / 465	8	-	0,90	BR6FS	4323	BR6FIX	2318
HP 450	8	-	1,00	BR6FS	4323	BR6FIX	2318
HP 500 (502 cid)	8	94-98	1,00	BR6FS	4323	BR6FIX	2318
HP 500 (502 cid) (Gen+)	8	-	1,00	BR6FS	4323	BR6FIX	2318
HP 500 (540 cid)	8	-	0,90	R5673-8	4140	-	-
HP 500 EFI (502 cid)	8	98-05	1,00	BR6FS	4323	BR6FIX	2318
HP 525 EFI (502 cid)	8	-	0,90	BR6ES	4922	-	-



Modèle

Cyl.



N° STOCK



N° STOCK IX

HP 525SC (454 cid)	8	91-99	0,90	R5673-8	4140	-	-
HP 575	8	-	0,90	R5673-8	4140	-	-
HP 575 SCi	8	00-05	1,00	R5673-8	4140	-	-
HP 600SC	8	91-93	0,90	BR6FS	4323	BR6FIX	2318
HP 600SC	8	93-96	0,90	R5673-8	4140	-	-
HP 600 / 700 SCi	8	-	0,90	BR6ES	4922	-	-
HP 800SC	8	-	0,90	R5673-8	4140	-	-
HP 850 SCi	8	-	0,80	BR9ECS	3570	-	-
HP 900SC	8	-	0,60	R5671A-9	7382	-	-
HP 900SC (Carter sec)	8	-	0,60	R5671A-9	7382	-	-
HP 1075 Sci (Carter sec; N°0M905359->)	8	-	0,80	BR9ECS	3570	-	-

STERN DRIVE - CHEVROLET SMALL BLOCK





5.0L (->N°0L000000)	8	-	0,90	YR5	7052	YR5IX	7516
5.0L EFI Gen+ (N°0L015751->)	8	-	1,10	BPR6EFS	3623	TR6IX	3689
5.0L Gen+ (N°L015751->)	8	-	1,10	BPR6EFS	3623	TR6IX	3689
5.0L MPI Gen+ (N°0M320415->)	8	-	1,50	-	-	TR55IX	7164
5.0LX	8	-	0,90	YR5	7052	YR5IX	7516
5.7LX	8	-	1,00	BR6FS	4323	BR6FIX	2318
5.7LX Bravo EFI (Gen+)	8	96-97	1,10	-	-	TR5IX	7397
5.7LX EFI	8	-	1,00	BR6FS	4323	BR6FIX	2318
5.7LX EFI Gen+	8	-	1,10	BPR6EFS	3623	TR6IX	3689
190	8	-	0,90	XR5	3332	XR5IX	7355
225 (->N°2278646)	8	-	0,90	B7S	3710	-	-
225 (N°2278647->)	8	-	0,90	XR5	3332	XR5IX	7355
228 / 230	8	-	0,90	YR5	7052	YR5IX	7516
250 (->N°2639854)	8	-	0,80	B7S	3710	-	-
250 (N°4768000->)	8	-	0,90	BR6FS	4323	BR6FIX	2318
255 / 260	8	-	0,90	BR6FS	4323	BR6FIX	2318
270	8	-	0,80	B7S	3710	-	-
270 - siège conique	8	-	0,90	R5673-8	4140	-	-
280	8	-	0,90	BR6FS	4323	BR6FIX	2318
300 Tempest	8	-	0,90	BR6FS	4323	BR6FIX	2318
320 EFI	8	87-89	0,90	BR6FS	4323	BR6FIX	2318
350 Mag	8	-	1,00	BR6FS	4323	BR6FIX	2318
350 Mag EFI Gen+ (N°0F800500->)	8	-	1,10	BPR6EFS	3623	TR6IX	3689
350 Mag MPI Gen+ (N°0F602000->N°0M320489)	8	-	1,10	BPR6EFS	3623	TR6IX	3689
350 Mag MPI Gen+ (N°0M320590->)	8	-	1,50	TR55	3951	TR55IX	7164
350 Mag MPI Gen+ Horizon (N°0L304700->0M309999)	8	-	0,90	TR5	2238	TR5IX	7397
350 Mag MPI Gen+ Horizon (N°0M310000->)	8	-	1,50	TR55	3951	TR55IX	7164
350 Mag EFI/MP (->N°0F602199)	8	-	1,00	BR6FS	4323	BR6FIX	2318
898, 200	8	-	0,90	YR5	7052	YR5IX	7516
MX 6.2 MPI (->N°0M320613)	8	-	1,10	BPR6EFS	3623	TR6IX	3689
MX 6.2 MPI (N°0M320614->)	8	-	1,50	TR55	3951	TR55IX	7164
MX 6.2 MPI Horizon (N°0M320614->)	8	-	1,50	TR55	3951	TR55IX	7164
Scorpion 377 (N°0L416146->)	8	-	1,10	BPR6EFS	3623	TR6IX	3689

STERN DRIVE - FORD SMALL BLOCK

215 (302 cid)	8	70-72	0,80	AR6FS	3323	-	-
225	8	06-	0,80	BPR6FS	2623	UR6IX	7348
225 (302 cid)	8	73-74	0,80	AR6FS	3323	-	-
255 (->N°4175498)	8	-	0,80	BR6FS	4323	BR6FIX	2318
255 (N°4175499->) - Ø14mm	8	-	0,80	BPR6FS	2623	UR6IX	7348
255 (N°4175499->) - Ø18mm	8	-	0,80	AR6FS	3323	-	-
888 (N°4169597->) - Ø14mm	8	-	0,80	BPR6FS	2623	UR6IX	7348
888 (N°4169597->) - Ø18mm	8	-	0,80	AR6FS	3323	-	-
888 (->N°4169596)	8	-	0,80	AR6FS	3323	-	-

STERN DRIVE - GM

98 cid - 100 Vazer	4	07-09	0,90	BR9ES	5722	BR9EIX	3981
110	4	63-66	0,90	BR6ES	4922	-	-
120 (->N°3825578)	4	64-74	0,90	BR6ES	4922	-	-
120 (N°3825579->)	4	75-86	0,90	BR6FS	4323	BR6FIX	2318
140 (->N°3826282)	4	68-74	0,90	BR6ES	4922	-	-
140 (N°3826283->)	4	74-86	0,90	BR6FS	4323	BR6FIX	2318
185 - 2 bbl (262 cid)	6	85-87	0,90	BR6FS	4323	BR6FIX	2318
185 - 4 bbl (229 cid)	6	83-84	0,90	BR6FS	4323	BR6FIX	2318
190 (283 cid)	8	63-64	0,90	BR6FS	4323	BR6FIX	2318
198 MIE (305 cid)	8	-	0,90	BR6FS	4323	BR6FIX	2318
200 (305 cid)	8	85-87	0,90	BR6FS	4323	BR6FIX	2318
225 MIE (327 cid)	8	-	0,80	B8S	3810	-	-
228 (305 cid)	8	77-84	0,90	BR6FS	4323	BR6FIX	2318
228 MIE (305 cid)	8	77-80	0,90	BR6FS	4323	BR6FIX	2318
230 (305 cid)	8	85-87	0,90	BR6FS	4323	BR6FIX	2318
230 MIE (LH / RH) (305 cid)	8	81-87	0,90	BR6FS	4323	BR6FIX	2318
250 (350 cid)	8	-	0,90	BR6FS	4323	BR6FIX	2318
250 MCM & MIE (327 cid)	8	68-69	0,80	B8S	3810	-	-
250 MCM & MIE (350 cid)	8	75-76	0,90	BR6FS	4323	BR6FIX	2318
260 (350 cid)	8	78-87	0,90	BR6FS	4323	BR6FIX	2318
260 MIE (350 cid) (LH / RH)	8	81-87	0,90	BR6FS	4323	BR6FIX	2318
262 Mag TBI (Gen+)	6	96-97	1,10	-	-	TR5IX	7397
270 MCM & MIE (350 cid)	8	69-72	0,80	B8S	3810	-	-

 Modèle	Cyl.				N° STOCK		N° STOCK IX
280 TRS (350 cid)	8	75-76	0,90	BR6FS	4323	BR6FIX	2318
300 (300 cid)	8	85-86	0,90	BR6FS	4323	BR6FIX	2318
370 TRS (454 cid)	8	78-87	0,90	BR6FS	4323	BR6FIX	2318
370 TRS (454 cid)	8	78-85	0,90	R5673-8	4140	-	-
400 TRS (454 cid)	8	80-86	0,90	BR6FS	4323	BR6FIX	2318
400 TRS (454 cid)	8	80-86	0,90	R5673-8	4140	-	-
420 (454 cid)	8	87-89	0,90	BR6FS	4323	BR6FIX	2318
425 (454 cid)	8	90-93	0,90	BR6FS	4323	BR6FIX	2318
440 TRS	8	83-86	0,90	BR6FS	4323	BR6FIX	2318
440 TRS	8	83-86	0,90	R5673-8	4140	-	-
500 Bulldog (540 cid)	8	90-96	0,90	BR6FS	4323	BR6FIX	2318
500 Bulldog (540 cid)	8	97-01	1,00	BR6FS	4323	BR6FIX	2318
898 (305 cid)	8	77-84	0,90	BR6FS	4323	BR6FIX	2318
2.5L (153 cid)	4	87-89	0,90	BR6FS	4323	BR6FIX	2318
3.0L (181 cid) (N°0L010042->)	4	-	0,90	BPR6EFS	3623	TR6IX	3689
3.0L (181 cid) (->N°0F353100->)	4	-	0,90	BR6FS	4323	BR6FIX	2318
3.0L MPI (181 cid)	4	08-	1,10	-	-	TR5IX	7397
3.0LX	4	90-91	0,90	BR6FS	4323	BR6FIX	2318
3.0LX	4	91-97	0,90	BPR6EFS	3623	TR6IX	3689
4.3L (262 cid)	6	88-92	0,90	BR6FS	4323	BR6FIX	2318
4.3L (262 cid)	6	93-96	1,00	BR6FS	4323	BR6FIX	2318
4.3L (262 cid) (Gen+)	6	98-	1,10	-	-	TR5IX	7397
4.3L (262 cid) (Gen+) (TBI)	6	98-01	1,10	-	-	TR5IX	7397
4.3L MPI (262 cid)	6	02-	1,50	ITR4A15	5599	-	-
4.3L MPI EC (262 cid)	6	11-	1,50	ITR4A15	5599	-	-
5.0L (305 cid)	8	88-95	0,90	BR6FS	4323	BR6FIX	2318
5.0L (305 cid) (Gen+)	8	98-	1,10	-	-	TR5IX	7397
5.0L EFI (305 cid) (Gen+)	8	98-01	1,10	-	-	TR5IX	7397
5.0L LX (305 cid)	8	88-95	0,90	BR6FS	4323	BR6FIX	2318
5.0L MIE (305 cid) (LH / RH)	8	-	0,90	BR6FS	4323	BR6FIX	2318
5.0L MPI (305 cid)	8	02-	1,50	ITR4A15	5599	-	-
5.0L MPI EC (305 cid)	8	08-	1,50	ITR4A15	5599	-	-
8.1S HO MIE (496 cid)	8	01-	1,50	PZTR5A-15	7862	-	-
8.1S HO MIE EC (496 cid)	8	08-	1,50	PZTR5A-15	7862	-	-
STERN DRIVE - MERCURY MARINE							
3.7 L / LX- 224 cid	4	88-89	0,90	BPR6FS	2623	UR6IX	7348
8.2 Mag / Mag EC / Mag MIE / Mag MIE EC	8	10-	0,90	BPR6ES	7822	BPR6EIX	6637
8.2 MIE	8	90-96	0,90	BR6FS	4323	BR6FIX	2318
8.2 MIE EC	8	10-	0,90	BPR6ES	7822	BPR6EIX	6637
8.2 MPI MIE	8	96-01	1,00	BR6FS	4323	BR6FIX	2318
165 / 180 - 224 cid	4	-	0,90	BPR6FS	2623	UR6IX	7348
170 / 190 - 224 cid	4	85-86	0,90	BPR6FS	2623	UR6IX	7348
377 Mag / Mag EC (377 cid)	8	08-	1,50	ITR4A15	5599	-	-
470 - 224 cid	4	76-84	0,90	BPR6FS	2623	UR6IX	7348
485 - 224 cid	4	80-82	0,90	BPR6FS	2623	UR6IX	7348
488 - 224 cid	4	83-84	0,90	BPR6FS	2623	UR6IX	7348
STERN DRIVE - RENAULT							
60	4	-	0,60	BR6HS	3922	BR6HIX	3419
80	4	-	0,60	BPR6ES	7822	BPR6EIX	6637
90	4	-	0,80	BPR6ES	7822	BPR6EIX	6637

MERCURY

90 HP							
Sport Jet		94-	0,90	BZ7HS-10	3579	-	-
Sport Jet		95-	1,00	BZ7HS-10	3579	-	-
95 HP							
Sportjet 95XR		96-97	1,00	BZ7HS-10	3579	-	-
120 HP							
Sportjet 120		95-	1,00	BZ7HS-10	3579	-	-
Sportjet 120XR		96-99	0,80	BZ7HS-10	3579	-	-
175 HP							
Sportjet 175XR		97-06	-	BUZ8H	7447	-	-
200 HP							
Sport Jet		06-	0,80	IZFR5G	5887	-	-
210 HP							
M2 Sport Jet		00-06	-	BUZ8H	7447	-	-
240 HP							
M2 Sport Jet		00-06	1,00	BPZ8HS-10	3133	-	-
250 HP							
M2 Sport Jet		06-	0,80	IZFR5G	5887	-	-

OMC

AJ / AT / TJ / TT - Ø14mm		-	0,90	XR5	3332	XR5IX	7355
AJ / AT / TJ / TT - Ø14mm, siège conique		-	0,90	UR5	2771	UR5IX	7177
JET DRIVE							
Turbojet 90 / 115		-	0,80	BZ7HS-10	3579	-	-
SAIL DRIVE							
15S10G / 15S10S / 15S11C / 15S13A / 15S14M		77-84	1,10	BPR6HS	7022	BPR6HIX	4085



Modèle

Cyl.



N° STOCK



N° STOCK IX

SEA DRIVE





1.6L 115-SD	85-91	0,80	BZ7HS-10	3579	-	-
1.8L / 2.0L 140-SD	85-91	0,80	BZ7HS-10	3579	-	-
2.5L	81-84	-	BUHXW-1	5526	-	-
2.6L 190-SD	85-88	-	BUHXW-1	5526	-	-
2.7L 225-SD	87-	0,80	BZ7HS-10	3579	-	-
3.0L 225-SD	85-91	0,80	BZ7HS-10	3579	-	-
3.6L 275-SD	87-81	0,80	BZ7HS-10	3579	-	-
4.0L 300-SD	85-91	0,80	BZ7HS-10	3579	-	-

STERN DRIVE

Ø14mm	73-74	0,90	B6ES	7310	-	-
Ø14 mm - Siège conique	73-85	0,90	UR5	2771	UR5IX	7177
Ø18 mm - Siège conique	74-	0,80	AR6FS	3323	-	-
2.3L Cobra	87-90	0,90	TR5	2238	TR5IX	7397
2.5L	82-86	0,90	BR6FS	4323	BR6FIX	2318
3.0L	82-89	0,90	BR6FS	4323	BR6FIX	2318
3.0L Cobra	87-92	1,10	UR4	6630	UR4IX	7401
3.0L Cobra	93-98	1,10	TR5	2238	TR5IX	7397
3.0L Cobra HO	90-98	1,10	TR5	2238	TR5IX	7397
3.8L	82-85	0,90	YR5	7052	YR5IX	7516
4.3L	91-93	0,90	BR6FS	4323	BR6FIX	2318
4.3L	97-98	0,90	TR4	3754	TR4IX	7300
4.3L - Modeles 'A'	96-	0,90	UR4	6630	UR4IX	7401
4.3L - Modeles 'S'	96-	0,90	TR4	3754	TR4IX	7300
4.3L Cobra	86-95	0,90	UR4	6630	UR4IX	7401
4.3L Cobra HO	90-91	0,90	UR4	6630	UR4IX	7401
4.3L Cobra HO	93-95	1,10	UR4	6630	UR4IX	7401
4.3L Stinger	78-86	0,80	UR4	6630	UR4IX	7401
5.0L	82-85	0,90	YR5	7052	YR5IX	7516
5.0L	98-	0,90	TR4	3754	TR4IX	7300
5.0L Cobra (Carb)	86-96	0,90	UR4	6630	UR4IX	7401
5.0L Cobra (EFI)	96-	0,90	TR4	3754	TR4IX	7300
5.0L Cobra EFI	93-95	1,10	TR5	2238	TR5IX	7397
5.0L Cobra HO	89-95	0,90	UR4	6630	UR4IX	7401
5.7L	82-	0,90	BR6FS	4323	BR6FIX	2318
5.7L	83-	0,90	YR5	7052	YR5IX	7516
5.7L	84-85	0,90	BR6FS	4323	BR6FIX	2318
5.7L	98-	0,90	TR4	3754	TR4IX	7300
5.7L - Modèle 57FC	97-	0,90	TR4	3754	TR4IX	7300
5.7L - Sauf modèle 57FC	97-	0,90	UR4	6630	UR4IX	7401
5.7L Cobra	86-92	0,90	UR4	6630	UR4IX	7401
5.7L Cobra	96-	0,90	UR4	6630	UR4IX	7401
5.7L K	93-95	1,10	UR4	6630	UR4IX	7401
5.7L King Cobra	86-92	0,90	UR4	6630	UR4IX	7401
5.8L Cobra (Carb)	89-96	0,90	UR4	6630	UR4IX	7401
5.8L Cobra EFI	92-96	1,10	TR5	2238	TR5IX	7397
5.8L King Cobra EFI HO	93-95	1,10	TR5	2238	TR5IX	7397
7.4L	97-	1,10	BPR6EFS	3623	TR6IX	3689
7.4L	98-	0,90	UR4	6630	UR4IX	7401
7.4L - 744 EP & FP modes	96-	0,90	UR4	6630	UR4IX	7401
7.4L - 744 FF & FG modes	96-	1,10	BPR6EFS	3623	TR6IX	3689
7.4L Cobra (Carb)	90-95	1,10	UR4	6630	UR4IX	7401
7.4L Cobra HO	91-93	1,10	UR4	6630	UR4IX	7401
7.4L King Cobra / King Cobra EFI	95-	1,10	UR4	6630	UR4IX	7401
7.5L Cobra	86-90	0,90	UR4	6630	UR4IX	7401
8.2L King Cobra	92-98	1,10	UR4	6630	UR4IX	7401
480	-	0,80	B8S	3810	-	-
CU / GU	-	0,90	B6ES	7310	-	-
DU	-	0,80	B8S	3810	-	-
HU	-	0,90	XR5	3332	XR5IX	7355
JU	-	0,90	BR6FS	4323	BR6FIX	2318
KU	-	0,90	B6S	3510	-	-
LU	-	0,90	B6ES	7310	-	-
NU	-	0,60	BP6ES	7811	BPR6EIX	6637
Stinger	78-86	0,90	UR4	6630	UR4IX	7401
SU	-	0,90	B6ES	7310	-	-
TU-14 / 15 / 16	-	0,90	XR5	3332	XR5IX	7355
TU-17	-	0,90	B6S	3510	-	-
TU-20 / 21,	-	0,90	BR6FS	4323	BR6FIX	2318
VU	-	0,90	B6ES	7310	-	-
WU, XU-20C	-	0,90	BR6FS	4323	BR6FIX	2318
XU20S	-	0,90	B6S	3510	-	-

PALMER-GREENW.

M196 / 265 / 392 / 304 / 345 / 345B / 392B / 549	-	0,80	B6S	3510	-	-
MKIV-115, MKVI-150	-	0,80	B6S	3510	-	-
MKVIII: 200, 225, 275, 300	-	0,80	B6S	3510	-	-
P 302 / 351, PA 190 / 220 / 255	-	0,80	AP6FS	2710	-	-
PA350	-	0,80	BPR5FS	2423	UR5IX	7177

 Modèle	Cyl.				N° STOCK		N° STOCK IX
PB-V-215 (V-8)	8	-	0,90	B6HS	4510	BR6HIX	3419
PW27 - Ø14mm	-	-	0,80	BP5S	3011	XR5IX	7355
PW27 - Ø18mm	-	-	0,80	AB-6	2910	-	-
Y304, Y345, Y392	-	-	0,80	B6S	3510	-	-

PANTHER

400 Plus C, 500 Plus, F 110 / 140, M 405 / 454	76-80	1,10	UR4	6630	UR4IX	7401
400 Plus-F, M460	76-80	0,80	UR5	2771	UR5IX	7177
F 185 / 235, M360	76-80	0,90	BPR5ES	7422	BPR5EIX	6597

PCM

5.7L HO MPI	-	1,10	TR4	3754	TR4IX	7300
5.7L HO Ski TBI - 275hp	-	1,10	UR4	6630	UR4IX	7401
5.8L Carburateur - 260hp	-	0,70	UR6	7773	UR6IX	7348
5.8L HO MPI - 310hp	-	1,10	TR4	3754	TR4IX	7300
7.4L MPI	-	1,10	TR4	3754	TR4IX	7300
7.4L Carburateur	-	1,10	UR4	6630	UR4IX	7401
7.4L HO TBI - 350hp	-	1,10	UR4	6630	UR4IX	7401
150 / 200 / 220 / 229 / 230 / 250 / 280 / 305 / 350 cid	-	1,10	UR4	6630	UR4IX	7401
302 cid - Ø14mm	-	1,10	UR4	6630	UR4IX	7401
302 cid - Ø18mm	-	0,80	AR6FS	3323	-	-
351 cid - Ø14mm	-	1,10	UR4	6630	UR4IX	7401
351 cid - Ø18mm	-	0,80	AR6FS	3323	-	-
454 cid	-	1,10	UR4	6630	UR4IX	7401
460 cid - Ø14mm	-	1,10	UR4	6630	UR4IX	7401
460 cid - Ø18mm	-	0,80	AR6FS	3323	-	-

POLARIS

JET DRIVE

Optimax 3.0L 250 HP-EX 2100/LE2100	04-	1,10	PZFR5F-11	4363	-	-
------------------------------------	-----	------	-----------	------	---	---

REDLINE

5.0L 302 cid	-	0,90	BPR6FS	2623	UR6IX	7348
5.8L 351 cid	-	0,90	BPR6FS	2623	UR6IX	7348
5.8L 351 cid HO	-	1,00	BPR6EFS	3623	TR6IX	3689
7.5L 460 cid	-	0,90	BPR6FS	2623	UR6IX	7348

ROLLS-ROYCE

LM841	-	0,90	B5ES	6410	-	-
Moteur V8	8	0,60	B5ES	6410	-	-

SIMPLEX

15 hp - Marine Ford Conversion	-	0,80	B5HS	4210	-	-
--------------------------------	---	------	------	------	---	---

TOYOTA

4.0L 300 hp - Epic 21 / Epic 22 / S22 / X22	-	1,10	IFR6T11	4589	-	-
4.0L - Epic VT 300i	8	1,10	PFR5G-11	2647	-	-

U. S. MARINE





3.0L - 181 cid	-	0,90	BR5ES	4722	-	-
5.0L 225 hp - 305 cid	-	0,90	BR6FS	4323	BR6FIX	2318
5.7L 260 hp - 350 cid	-	0,90	BR6FS	4323	BR6FIX	2318
5.8L 240 hp - 351 cid	-	1,00	UR5	2771	UR5IX	7177
7.4L 330 hp - 454 cid	-	0,90	BR6FS	4323	BR6FIX	2318
7.5L 340 hp - 460 cid	-	1,00	UR5	2771	UR5IX	7177





UNIVERSAL

Arrow, Atomic 1 / 2 / 3 / 4 / Stevedore	-	0,90	B6S	3510	-	-
Big King	-	0,90	-	-	WR5IX	7510
Bluefin, Bullit, Colt	-	0,90	B6S	3510	-	-
DX Super Sabre	-	0,90	XR5	3332	XR5IX	7355
Elf, Knight, Marlin	-	0,80	B6S	3510	-	-
LEV / LEVH 188 hp, Little King	-	0,70	B6S	3510	-	-
NKEV 277 hp	-	0,90	-	-	WR5IX	7510
Sabre 140 hp - 198 cid	-	0,90	XR5	3332	XR5IX	7355
Strato King, Tarpon	-	0,80	B6S	3510	-	-
Super Sabre 155 hp - 225 cid	-	0,90	XR5	3332	XR5IX	7355
ZDrive	-	0,90	B6S	3510	-	-

VOLVO-PENTA

5.7L GXI	-	1,50	TR55	3951	TR55IX	7164
5.8L FL 4 bbl	-	0,90	UR4	6630	UR4IX	7401

 Modèle	Cyl.				N° STOCK		N° STOCK IX
5.8L FSI EFI HO	-	-	0,90	BPR6EFS	3623	TR6IX	3689
7.4L Gi EFI	-	-	1,10	BPR6FS	2623	UR6IX	7348
7.4L GL 4 bbl / GSi EFI	-	-	1,10	BR6FS	4323	BR6FIX	2318
8.1L Gi/GSi	-	-	1,50	TR4	3754	TR4IX	7300
8.1L GXi	-	-	1,50	TR55	3951	TR55IX	7164
8.2L GSi EFI	-	-	1,10	BR6FS	4323	BR6FIX	2318
Chevrolet 305 cid PZ200 I/O	-	-	0,90	BR6FS	4323	BR6FIX	2318
SÉRIE B							
B 16A / 16C	-	-	0,60	XR5	3332	XR5IX	7355
B 18A	-	-	0,60	B6HS	4510	BR6HIX	3419
SÉRIE BB							
BB 25 / 70	-	-	0,60	B6S	3510	-	-
BB 30B	-	-	0,60	B6HS	4510	BR6HIX	3419
BB 30F	-	-	0,90	B5HS	4210	-	-
BB 70 (Utilisation à vitesse soutenue)	-	-	0,60	B8S	3810	-	-
BB 100 / 100A	-	-	0,60	B6HS	4510	BR6HIX	3419
BB 115A / 115B / 115C / 165A / 170A / 170B	-	-	0,60	BP7HS	5111	BPR7HIX	5944
BB 140 / 145	-	-	0,90	BP6ES	7811	BPR6EIX	6637
BB 140A / 145C	-	-	0,60	BP8ES	2912	BPR8EIX	6684
BB 225 / 260	-	-	0,90	BR6FS	4323	BR6FIX	2318
SÉRIE C							
C 5 / 10 / 23	-	-	0,60	AB-6	2910	-	-
SÉRIE M							
MB 2 / 50S	-	-	0,60	D6HA	6512	-	-
MB 10 / 10A / 100S	-	-	0,60	BP5HS	4111	-	-
MB18F	-	-	0,90	B5HS	4210	-	-
MB 20A / 20B	-	-	0,60	BP6HS	4511	BPR6HIX	4085
MB 36A / 36B	-	-	0,60	B6S	3510	-	-
SÉRIE OCEAN							
4.3L / 5.0L OSi-XPD	-	-	0,90	TR5	2238	TR5IX	7397
5.7L OSi / OSi-XPD	-	-	0,90	TR5	2238	TR5IX	7397
STERN DRIVE - AQ							
145A / 145B	-	-	0,90	BP7ES	2412	BPR7EIX	4055
AQ 60F	-	-	0,90	B5HS	4210	-	-
AQ 80	-	-	0,60	B6S	3510	-	-
AQ 90	-	-	0,60	B6HS	4510	BR6HIX	3419
AQ 95 / 95A / 100	-	-	0,60	BP6HS	4511	BPR6HIX	4085
AQ 105A / 110 / 115A / 120	-	-	0,60	BP7HS	5111	BPR7HIX	5944
AQ 120 (B21) / 125A / 125B / 145	-	-	0,90	BP6ES	7811	BPR6EIX	6637
AQ 130A / 130B / 130C / 130D	-	-	0,60	BP7HS	5111	BPR7HIX	5944
AQ 131A / 131B / 131C / 131D / 140A	-	-	0,90	BP7ES	2412	BPR7EIX	4055
AQ 150A / 150B	-	-	0,90	XR5	3332	XR5IX	7355
AQ 151A / 151B / 151C	-	-	0,60	BP7ES	2412	BPR7EIX	4055
AQ 165A / 170A / 170B / 170C	-	-	0,60	BP7HS	5111	BPR7HIX	5944
AQ 171A / 171C	-	-	0,90	BP6ES	7811	BPR6EIX	6637
AQ 175 / 175A / 190	-	-	0,90	YR5	7052	YR5IX	7516
AQ 180	-	-	0,60	XR5	3332	XR5IX	7355
AQ 190A	-	-	0,60	AR6FS	3323	-	-
AQ 200 / 200A / 200B / 200C / 200D / 200F	-	-	0,60	UR5	2771	UR5IX	7177
AQ 205A / 211 / 211A / 211DP	-	-	0,90	YR5	7052	YR5IX	7516
AQ 210A (->N°177314)	-	-	0,60	B6S	3510	-	-
AQ 210A (N°177315->)	-	-	0,60	UR6	7773	UR6IX	7348
AQ 225 / 225A / 225B / 225C / 225D	-	-	0,60	UR6	7773	UR6IX	7348
AQ 225E / 225F / 231 / 231A / 231B / 231DP	-	-	0,90	YR5	7052	YR5IX	7516
AQ 230A	-	-	0,90	BPR6ES	7822	BPR6EIX	6637
AQ 240A / 255B	-	-	0,60	UR6	7773	UR6IX	7348
AQ 260 / 260A / 260B / 271A / 271B / 271C / 271D	-	-	0,60	BR6FS	4323	BR6FIX	2318
AQ 271 / 271DP	-	-	0,90	YR5	7052	YR5IX	7516
AQ 280A	-	-	0,60	UR6	7773	UR6IX	7348
AQ 290A / 290B / 311A / 311B / 430 / 531	-	-	0,60	BR6FS	4323	BR6FIX	2318
AQ 500A / 501A / 570A / 571A / 572 / 740A	-	-	0,90	BR6FS	4323	BR6FIX	2318
STERN DRIVE - DPX							
5.7L DPX 375	-	-	1,50	TR55	3951	TR55IX	7164
7.4L DPX 385 GSi EFI	-	-	1,10	BR6FS	4323	BR6FIX	2318
8.1L DPX 420	-	-	1,50	TR55	3951	TR55IX	7164
8.2L DPX 415 GSi EFI	-	-	1,10	BR6FS	4323	BR6FIX	2318
STERN DRIVE - DUOPROP							
4.3L Gi EFI / GL 2 bbl / GS 4 bbl (Culot court)	-	-	1,10	BPR6FS	2623	UR6IX	7348
4.3L Gi EFI / GL 2 bbl / GS 4 bbl (Culot long)	-	-	1,10	BPR6EFS	3623	TR6IX	3689
5.0L Fi EFI	-	-	0,90	TR5	2238	TR5IX	7397
5.0L FL 2 bbl	-	-	0,90	UR4	6630	UR4IX	7401
5.0L Gi / GL Gen 1+	-	-	1,10	BPR6EFS	3623	TR6IX	3689
5.7L Gi / GLi EFI	-	-	1,10	BPR6FS	2623	UR6IX	7348
5.7L GL 2 bbl / GS 4 bbl	-	-	1,10	BR6FS	4323	BR6FIX	2318
5.7L GS / GSi Gen 1+	-	-	1,10	BPR6EFS	3623	TR6IX	3689
5.7L GXi	-	-	1,50	TR55	3951	TR55IX	7164
5.8L FL 4 bbl	-	-	0,90	UR4	6630	UR4IX	7401
5.8L FSI EFI HO	-	-	0,90	BPR6EFS	3623	TR6IX	3689
7.4L Gi EFI / GL 4 bbl / GSi EFI	-	-	1,10	BPR6FS	2623	UR6IX	7348
7.4L Gi L29	-	-	0,90	BPR6EFS	3623	TR6IX	3689

Modèle	Cyl.				N° STOCK		N° STOCK IX
8.2L GSi EFI	-	-	1,10	BR6FS	4323	BR6FIX	2318
STERN DRIVE - PjX WATER JET							
4.3L Gi EFI / GS 4 bbl	-	-	1,10	BPR6EFS	3623	TR6IX	3689
STERN DRIVE - SX COBRA							
3.0L GS 2 bbl	-	-	1,10	BPR6EFS	3623	TR6IX	3689
4.3L Gi EFI	-	-	1,10	BPR6FS	2623	UR6IX	7348
4.3L Gi EFI / GL 2 bbl / GS 4 bbl	-	-	1,10	BPR6EFS	3623	TR6IX	3689
5.0L Fi EFI	-	-	0,90	TR5	2238	TR5IX	7397
5.0L FL 2 bbl	-	-	0,90	UR4	6630	UR4IX	7401
5.0L Gi / GL Gen 1+	-	-	1,10	BPR6EFS	3623	TR6IX	3689
5.7L Gi EFI / GLi EFI	-	-	1,10	BPR6FS	2623	UR6IX	7348
5.7L GL 2 bbl / GS 4 bbl	-	-	1,10	BR6FS	4323	BR6FIX	2318
5.7L GS / GSi Gen 1+	-	-	1,10	BPR6EFS	3623	TR6IX	3689
5.7L GXi	-	-	1,50	TR55	3951	TR55IX	7164
5.8L FL 4 bbl	-	-	0,90	UR4	6630	UR4IX	7401
5.8L FSi EFI HO	-	-	0,90	BPR6EFS	3623	TR6IX	3689
7.4L Gi EFI / GL 4 bbl	-	-	1,10	BPR6FS	2623	UR6IX	7348
7.4L Gi L29	-	-	0,90	BPR6EFS	3623	TR6IX	3689

VOLKSWAGEN

SDI 45 / 60-4	4	01-	12V	Y-732J	5605	-	-
SDI 50-4	4	-	12V	Y-732J	5605	-	-
SDI 55 / 75-5	5	01-	12V	Y-732J	5605	-	-
TDI 100 / 150-5	5	01-	12V	Y-732J	5605	-	-
TDI 115-4	4	01-	12V	Y-732J	5605	-	-
TDI 120 / 165-5	5	-	12V	Y-732J	5605	-	-
TDI 225-6	6	-	12V	Y-732J	5605	-	-

WEST-BEND

SHARK-O-MATIC	-	-	0,80	B7S	3710	-	-
---------------	---	---	------	-----	------	---	---

WISCONSIN

ABM / AEM / AKM / TFM / VH4M	-	-	0,60	AB-6	2910	-	-
------------------------------	---	---	------	------	------	---	---

YAMAHA

110	63-66	-	0,80	B6ES	7310	-	-
1000 CC							
AR230	04-06	-	0,80	CR9EB	6955	CR9EIX	3521
SR230	03-05	-	0,80	CR9EB	6955	CR9EIX	3521
SX230	03-06	-	0,80	CR9EB	6955	CR9EIX	3521
1100 CC							
212 S / X	08-10	-	0,80	CR9EB	6955	CR9EIX	3521
232 Limited	08-09	-	0,80	CR9EB	6955	CR9EIX	3521
AR210	03-10	-	0,80	CR9EB	6955	CR9EIX	3521
AR230	03-05	-	0,80	CR9EB	6955	CR9EIX	3521
AR230 High Output	05-09	-	0,80	CR9EB	6955	CR9EIX	3521
Exciter 220	96-98	-	0,60	BR8HS	4322	BR8HIX	7001
SR210	07-	-	0,80	CR9EB	6955	CR9EIX	3521
SR230	03-05	-	0,80	CR9EB	6955	CR9EIX	3521
SR230 High Output	07-	-	0,80	CR9EB	6955	CR9EIX	3521
SX210	07-	-	0,80	CR9EB	6955	CR9EIX	3521
SX230	03-05	-	0,80	CR9EB	6955	CR9EIX	3521
SX230 High Output	05-09	-	0,80	CR9EB	6955	CR9EIX	3521
1200 CC							
AR210	03-05	-	0,60	BR8HS	4322	BR8HIX	7001
Exciter 135 / 227 / 270	98-99	-	0,60	BR8HS	4322	BR8HIX	7001
LS2000	99-03	-	0,60	BR8HS	4322	BR8HIX	7001
LX2000	02-	-	0,60	BR8HS	4322	BR8HIX	7001
LX210	03-05	-	0,60	BR8HS	4322	BR8HIX	7001
XR1800	00-01	-	1,10	BR8ES-11	7986	-	-
STERN DRIVE							
L4 3.0i	-	-	0,90	BR6FS	4323	BR6FIX	2318
V6	6	-	0,90	BR6FS	4323	BR6FIX	2318
V8	8	-	0,90	BR6FS	4323	BR6FIX	2318



BOUGIES D'ALLUMAGE



Hors-Bord



Modèle

Cyl.



N° STOCK



N° STOCK IX

AERO MARINE

Jet Pak	71-73	0,90	BP5S	3011	-	-
AM 4000 - 4 hp	70-73	0,90	BP5S	3011	-	-
AM 5000 M, AM 5000 E - 5 hp	70-72	0,90	B-6L	3212	-	-
AM 7500M, AM 7500E - 7,5 hp	70-73	0,90	BM6A	5921	-	-
AM 9000 - 9 hp	71-73	0,60	BM6A	5921	-	-

AILSA CRAIG

AL-23, O-11, O-21, O-22, O-41, O-411	-	0,60	AB-6	2910	-	-
--------------------------------------	---	------	------	------	---	---

AIRBOY

20, 40, 90 (B S)	-	0,80	B6S	3510	-	-
50	-	0,80	B6S	3510	-	-
90 (OMC)	-	0,80	AP5FS	2610	-	-
120	-	0,80	B-6L	3212	-	-

ALSPORT

Ø14mm	-	0,80	BR6HS	3922	BR6HIX	3419
Ø18mm	-	0,80	AB-7	3010	-	-

APACHE

J5, J9	-	0,80	BR6S	3522	-	-
--------	---	------	------	------	---	---

ARKOS

Aquascooter	-	0,50	B6HS	4510	BR6HIX	3419
-------------	---	------	------	------	--------	------

ARROW

4 / 5.5 / 7.5 PS	-	0,50	BP5S	3011	-	-
------------------	---	------	------	------	---	---

BEAVER

5.5 / 7.5 / 9.0 hp	-	0,70	XR4	5858	XR4IX	7189
--------------------	---	------	-----	------	-------	------

BIANCHI

125cc	-	0,50	B6S	3510	-	-
-------	---	------	-----	------	---	---

BLUEJET

3.5 hp	61-	0,80	BR6S	3522	-	-
5.0 hp	63-	0,70	BM4A	5628	-	-

BOATIMPELLER

Tous modèles	-	0,50	AB-6	2910	-	-
--------------	---	------	------	------	---	---

BOMBARDIER

Mot. 1503 - Speedster 20 / Sportster 4-TEC	-	0,70	DCPR8E	4339	DCPR8EIX	6546
Sportster LE-Di Mot. 947Di	-	1,10	ZFR4F-11	4043	-	-

BRIGGS & STRATTON

5.0 hp 4-cycle, OHV, Air Cooled	-	0,80	BKR5ES	2460	BKR5EIX	6341
---------------------------------	---	------	--------	------	---------	------



Modèle

Cyl.

N°
STOCKN°
STOCK IX

BRIT. SEAGULL

2 / 3 / 4 / 5 / 6 hp	-	0,50	AB-6	2910	-	-
45 / 55 / 60 / 75 / 80 / 90	-	0,50	AB-6	2910	-	-
125 / 160 / 170	-	0,80	B7ES	1111	BR7EIX	6664
Century, Century Plus, Featherweight, Forty Minus	-	0,50	AB-6	2910	-	-
Forty Plus (CD ign. -80 / Magneto ign. -80)	-	0,50	AB-6	2910	-	-
Minor BM	-	0,50	B6HS	4510	BR6HIX	3419
QB serie: Curlew, Osprey, Kingfisher	-	0,80	B7ES	1111	BR7EIX	6664
SD160	-	0,80	B7ES	1111	BR7EIX	6664
Silver Century, Silver Century Plus	-	0,50	AB-6	2910	-	-

BRITISH ANZANI

180 - 18 hp	-	0,70	B-6L	3212	-	-
65	-	0,70	B6S	3510	-	-
Fleetwin, Jet 3, Minor Seamaid, Magnitwin, Unitwin	-	0,60	B6HS	4510	BR6HIX	3419
Pilot 1 / 2 / 3 / 4 / 30, Seasprite, Supertwin, 400	-	0,60	B6HS	4510	BR6HIX	3419
Super Single, Super Snipe	-	0,60	AB-6	2910	-	-
Triton	-	0,60	B6ES	7310	-	-

CAL-JET

Econojet, Ramjet	-	0,80	B6S	3510	-	-
------------------	---	------	-----	------	---	---

CARNITI

18 / 280CN / 45 / 55 / 65 / 80	-	0,50	B8HS	5510	BR8HIX	7001
3 / 3.5 / 5 / 8 / 9.5 / 15 / 20 PS	-	0,50	B6HS	4510	BR6HIX	3419
25 / 40 / 50 / 70 / 85 / 100 PS	-	0,50	B6HS	4510	BR6HIX	3419
45S, 65S, 80S	-	0,80	B9HS	5810	BR9HIX	5687
700 Sport, 850 Sport, 1000 Sport	-	0,50	B8HS	5510	BR8HIX	7001

CARNITS

90.0 hp	-	0,80	BR6HS	3922	BR6HIX	3419
---------	---	------	-------	------	--------	------

CHIEF

J-5 / 200 / 300 / 350 / 400 / 500 / 700	-	0,80	BM6A	5921	-	-
J-9	-	0,80	BP5S	3011	-	-
K-150 / 200 / 300 / 400 / 990	-	0,80	BM6A	5921	-	-
K-201 / 505 / 550 / 751 / 753 / 900	76-78	0,60	BP5S	3011	-	-
K-350	76-78	0,60	BM6A	5921	-	-
K-500 / 700 / 750	73-	0,80	BM6A	5921	-	-
K-500 / 700 / 750	74-75	0,80	BP5S	3011	-	-

CHRIS-CRAFT

Challenger, Commander	-	0,70	B6S	3510	-	-
-----------------------	---	------	-----	------	---	---

CHRYSLER

3.5 hp	65-69	0,80	B-6L	3212	-	-
3.5 hp	80-84	0,80	BR6HS	3922	BR6HIX	3419
4.0 hp	76-84	0,80	BR6HS	3922	BR6HIX	3419
4.4 / 6.6 hp	68-	0,80	BR6HS	3922	BR6HIX	3419
4.5 hp	74-	0,80	BR6HS	3922	BR6HIX	3419
4.9 hp	73-75	0,80	BR5HS	3722	-	-
5.0 / 7.0 hp	69-70	0,80	BR6HS	3922	BR6HIX	3419
5.0 hp	74-76	0,80	BR5HS	3722	-	-
6.0 hp	65-67	0,80	BR5HS	3722	-	-
6.0 hp	71-77	0,80	BR6HS	3922	BR6HIX	3419
6.0 hp	78-82	0,80	BR6HS	3922	BR6HIX	3419
6.0 hp - Sailor 150	80-	0,80	B6HS	4510	BR6HIX	3419
7.5 hp	79-84	0,80	BR6HS	3922	BR6HIX	3419
7.5 hp - Sailor 180	81-84	0,80	B6HS	4510	BR6HIX	3419

CHRYSLER

Modèle

Cyl.

 N°
STOCK

 N°
STOCK IX

7.5 hp - Sailor 190, 12 hp - Sailor 300		79-	0,80	B6HS	4510	BR6HIX	3419
8.0 hp		79-81	0,80	BR6HS	3922	BR6HIX	3419
9.0 hp		65-	0,80	BR6S	3522	-	-
9.2 hp		66-67	0,80	BR6S	3522	-	-
9.9 hp		68-86	0,80	BR6HS	3922	BR6HIX	3419
9.9 hp - Sailor 250		79-84	0,80	B6HS	4510	BR6HIX	3419
10 hp		74-78	0,80	BR6HS	3922	BR6HIX	3419
12 hp		79-	0,80	BR6HS	3922	BR6HIX	3419
12.9 hp		71-73	0,80	BR6HS	3922	BR6HIX	3419
15 hp		74-84	0,80	BR6HS	3922	BR6HIX	3419
20 / 35 / 45 hp		65-67	0,80	BR6S	3522	-	-
20 hp		68-82	0,80	BR6HS	3922	BR6HIX	3419
25 hp		73-84	0,80	BR6HS	3922	BR6HIX	3419
30 hp		73-82	0,80	BR6HS	3922	BR6HIX	3419
35 / 45 hp		68-84	0,80	BR6HS	3922	BR6HIX	3419
45 hp-Magneto		71-78	-	BUHX	2522	-	-
50 hp		65-66	0,80	BR6S	3522	-	-
50 hp		81-84	0,80	BR6HS	3922	BR6HIX	3419
55 hp		67-76	0,80	B6HS	4510	BR6HIX	3419
55 hp		80-83	-	BUHW	2622	-	-
55 hp-Magneto		69-80	-	BUHX	2522	-	-
60 hp		74-76	-	BUHX	2522	-	-
60 hp		84-	-	BUHW	2622	-	-
65 hp		77-78	-	BUHX	2522	-	-
70 / 85 hp		69-73	-	BUHW	2622	-	-
70 hp		79-80	-	BUHW	2622	-	-
75 / 105 hp		66-67	0,80	BR6S	3522	-	-
75 hp		68-	-	BUHX	2522	-	-
75 hp		74-84	-	BUHW	2622	-	-
80 hp		65-	0,80	BR6S	3522	-	-
85 hp		78-83	-	BUHW	2622	-	-
85 hp		84-86	-	BUHX	2522	-	-
90 hp	3	74-77	-	BUHW	2622	-	-
90 hp		83-84	-	BUHW	2622	-	-
100 hp		79-84	-	BUHW	2622	-	-
105 hp		68-74	-	BUHW	2622	-	-
105 hp		75-76	-	BUHX	2522	-	-
105 hp		77-83	-	BUHW	2622	-	-
115 hp		77-82	-	BUHW	2622	-	-
115 hp		83-84	-	BUHX	2522	-	-
120 hp		70-77	-	BUHW	2622	-	-
125 hp		81-	-	BUHX	2522	-	-
130 hp		72-73	-	BUHW	2622	-	-
135 hp		69-71	-	BUHW	2622	-	-
135 hp		74-77	-	BUHW	2622	-	-
140 hp		78-84	-	BUHW	2622	-	-
150 hp		72-76	-	BUHW	2622	-	-

CLINTON

1.5 hp - K-150, 2.0 hp - J-200 / K-200		-	0,80	BM4A	5628	-	-
1.5 hp - K-150		76-79	0,60	BR6S	3522	-	-
2.0 hp - K-201		76-91	0,60	BR6S	3522	-	-
3.0 hp - J-300 / K-300, 3.5 hp - J-350		-	0,80	BM4A	5628	-	-
3.5 hp - K-350		76-87	0,60	BM4A	5628	-	-
4.0 hp - J-400 / K-400		-	0,80	BM4A	5628	-	-
5.0 hp - AJ-9 / BJ-9 / J-5 / J-500		-	0,80	BM4A	5628	-	-
5.0 hp - J-9		-	0,80	BR6S	3522	-	-
5.0 hp - K-500		73-73	0,80	BM4A	5628	-	-
5.0 hp - K-500		74-75	0,80	XR5	3332	XR5IX	7355
5.0 hp - K-505, 5.5 hp - K-550		76-91	0,60	XR5	3332	XR5IX	7355
7.0 hp - J-700, 9.9 hp - K-990		-	0,80	BM4A	5628	-	-
7.0 hp - K-700, 7.5 hp - K-750		73-	0,80	BM4A	5628	-	-
7.0 hp - K-700, 7.5 hp - K-750		74-75	0,80	XR5	3332	XR5IX	7355
7.5 hp - K-750		76-84	0,60	XR5	3332	XR5IX	7355
7.5 hp - K-751 / K-753, 9.0 hp - K-900		76-91	0,60	XR5	3332	XR5IX	7355
10 hp - W-100, 14 hp - W-140, 25 hp - W-250		-	0,60	BR6HS	3922	BR6HIX	3419

COAST TO COAST

4.6 hp		65-	0,80	BR6S	3522	-	-
--------	--	-----	------	------	------	---	---

COLT

3.0 hp		63-	0,80	BR6S	3522	-	-
5.0 hp		63-	0,90	BM4A	5628	-	-



Modèle

Cyl.

N°
STOCK

COMMODORE

N°
STOCK IX

COMMODORE

18.0 / 40.0 hp	-	0,80	BR6S	3522	-	-
----------------	---	------	------	------	---	---

COV. CLIMAX

FWA Mk.III, PPF	-	0,60	B8ES	2411	BR8EIX	5044
FWM 750 cc	-	0,60	B6ES	7310	-	-

COV. VICTOR

M14 x 12,7mm	-	0,60	B6HS	4510	BR6HIX	3419
M14 x 19mm	-	0,60	B6ES	7310	-	-
M18 X 12mm	-	0,50	AB-6	2910	-	-

CRUISE N`CARRY

1.5 hp	81-88	0,70	BM4A	5628	-	-
1.75 hp Moteur Xenoah	-	0,80	BR6S	3522	-	-
2.5 hp Moteur Xenoah	84-88	0,80	BR6S	3522	-	-
6.0 hp Moteur Xenoah	-	0,70	BPR5HS	6222	-	-

CUYUNA

40 hp	-	0,80	BR8ES	5422	BR8EIX	5044
-------	---	------	-------	------	--------	------

DELFINO

2.5 / 3 PS	-	0,50	B6S	3510	-	-
------------	---	------	-----	------	---	---

DM

DM 5 219 cid	-	0,80	B5HS	4210	-	-
--------------	---	------	------	------	---	---

DUCATI

100 / 150 / 200, Cucciolo 5 / 10 / 15 / 20 PS	-	0,50	B6HS	4510	BR6HIX	3419
Bambi 30	-	0,60	B6HS	4510	BR6HIX	3419

DYNAFOIL

Moteur Xenoah 340 / 440 cc	-	0,80	BR6ES	4922	-	-
----------------------------	---	------	-------	------	---	---

ELGIN

3.5 hp - 6091 / 6092 / 60900	-	0,80	BM4A	5628	-	-
9.0 hp - 6066 / 6067	-	0,80	BM4A	5628	-	-
12 hp - 6012	-	1,00	BR6S	3522	-	-
14 hp - 6013 / 6014 / 6015 / 6069	-	1,00	BR6S	3522	-	-
18 hp - 59661 / 59671	-	1,00	BR6S	3522	-	-
25 hp - 6025 / 6028 / 6032	-	1,00	BR6S	3522	-	-
27.7 hp - 6033 / 6035	-	1,00	BR6S	3522	-	-
28 hp - 6034 / 6036 / 6037 / 6038 / 6070	-	1,00	BR6S	3522	-	-
40 hp - 6040 / 6043 / 6047 / 59421 / 59461 / 59471	-	1,00	BR6S	3522	-	-
40 hp - 594001 / 594011 / 594031	-	1,00	BR6S	3522	-	-
43.7 hp - 6052 / 6053	-	1,00	BR6S	3522	-	-
45 hp - 6054 / 6055 / 6056 / 6057 / 6062 / 6063	-	1,00	BR6S	3522	-	-
60 hp - 6060 / 6061 / 6062 / 6063	-	1,00	BR6S	3522	-	-
75 hp - 6064 / 6065 / 6074 / 6075 / 6076 / 6077	-	1,00	BR6S	3522	-	-
75.2 hp - 6072 / 6073	-	1,00	BR6S	3522	-	-

EMERALD BAY

Banshee XS 50 / 80 hp	96-	0,90	B8ES	2411	BR8EIX	5044
-----------------------	-----	------	------	------	--------	------

ESKA

1707 / 1747 / 1777 / 1790	70-74	0,80	XR5	3332	XR5IX	7355
1.2 hp	77-78	0,60	BR6S	3522	-	-
1.6 hp	87-	0,60	BM4A	5628	-	-
2.5 hp	77-87	0,60	BM4A	5628	-	-
3.0 hp	61-	0,80	BR6S	3522	-	-
3.0 hp	67-69	0,80	BR6S	3522	-	-
3.0 / 4.5 / 5.5 hp	75-76	0,80	XR5	3332	XR5IX	7355
3.0 hp	80-	0,80	XR5	3332	XR5IX	7355
4.0 / 6.0 hp	63-	0,80	BR6S	3522	-	-
4.0 hp	77-78	0,80	XR5	3332	XR5IX	7355
5.0 hp	61-69	0,80	BR6S	3522	-	-
5.0 / 7.5 hp	70-87	0,80	XR5	3332	XR5IX	7355

ESKA

Modèle

Cyl.







 N°
STOCK

 N°
STOCK IX

7.0 hp		67-	0,80	BR6S	3522	-	-
7.0 hp		69-	0,80	XR5	3332	XR5IX	7355
9.5 / 14 hp		70-74	0,80	XR5	3332	XR5IX	7355
9.9 / 15.0 hp		76-87	0,80	XR5	3332	XR5IX	7355

EVINRUDE

Ø18mm		39-50	0,80	AB-6	2910	-	-
3.6L		85-86	0,80	BZ7HS-10	3579	-	-
Air Bouy Diving Unit		-	0,60	BM4A	5628	-	-
CD, JH		54-68	0,80	B6S	3510	-	-
FD, FDE		56-68	0,80	B6S	3510	-	-
JHF, JWF		67-68	0,80	B6S	3510	-	-
JW		52-68	0,80	B6S	3510	-	-
LD		65-68	0,80	B6S	3510	-	-
MQ		64-68	0,80	B6S	3510	-	-
RD, RDE, RDDS, RJE, RK		51-68	0,80	B6S	3510	-	-
RX		62-68	0,80	B6S	3510	-	-
RXE		65-68	0,80	B6S	3510	-	-
SC		68-	0,80	B6S	3510	-	-
TN, AD, QD, V4H, V4ML		52-66	0,80	B6S	3510	-	-
1.0 hp - 1R		68-70	0,80	B6S	3510	-	-
1.1 hp		46-47	0,80	B-4L	3112	-	-
1.2 hp - Magneto		86-90	0,80	B6S	3510	-	-
1.5 hp		68-70	0,80	B6S	3510	-	-
2.0 hp		68-70	0,80	B6S	3510	-	-
2.0 hp - 2R		71-84	0,80	B6S	3510	-	-
2.0 hp - Jr., Colt		71-90	0,80	B6S	3510	-	-
2.0 hp - 1 cyl.	1	91-98	0,80	BPR6HS	7022	BPR6HIX	4085
2.0 hp - Aquanaut Diving Unit		66-70	0,80	BM4A	5628	-	-
2.0 hp - Commercial		00-01	0,80	BZ7HS-10	3579	-	-
2.3 hp		91-97	0,80	BPR6HS	7022	BPR6HIX	4085
2.3 hp		98-99	0,80	BZ7HS-10	3579	-	-
2.5 hp		87-88	0,80	BZ7HS-10	3579	-	-
3.0 hp		52-68	0,80	B6S	3510	-	-
3.0 hp		99-	0,80	BZ7HS-10	3579	-	-
3.0 hp - 2 cyl.	2	89-97	0,80	BR6HS	3922	BR6HIX	3419
3.0 hp - Lightwin		52-74	0,80	B6S	3510	-	-
3.3 hp		48-51	0,80	B6S	3510	-	-
3.3 hp - 1 cyl.	1	91-03	0,80	BPR6HS	7022	BPR6HIX	4085
3.4 hp - Yachtwin		64-74	0,80	B6S	3510	-	-
3.5 hp		01-	0,80	BPR6HS	7022	BPR6HIX	4085
4.0 hp		77-87	0,80	BR6HS	3922	BR6HIX	3419
4.0 hp		81-84	0,80	BZ7HS-10	3579	-	-
4.0 hp - 2 cyl.	2	89-98	0,80	BR6HS	3922	BR6HIX	3419
4.0 hp - 4R, 4W		69-76	0,80	B6S	3510	-	-
4.0 hp - Ultra, Excel		87-88	0,80	BZ7HS-10	3579	-	-
4.0 hp - V4, V4A, V4M, V4S, VX, VXH		58-67	0,80	B6S	3510	-	-
4.0 hp - Yachtwin		64-74	0,80	B6S	3510	-	-
4.5 hp		80-85	0,80	BR6HS	3922	BR6HIX	3419
5.0 hp		90-97	0,80	BR6HS	3922	BR6HIX	3419
5.0 hp		98-	0,80	BZ7HS-10	3579	-	-
5.0 hp - 4 temps OHC 128cc		97-03	0,70	D6HA	6512	-	-
5.0 hp - 4 temps OHC 138cc		03-	0,80	BPR6ES	7822	BPR6EIX	6637
5.0 hp - Angler		65-68	0,80	B6S	3510	-	-
5.2 hp - Lightwin		52-74	0,80	B6S	3510	-	-
5.5 hp		54-64	0,80	B6S	3510	-	-
5.5 hp - Fisherman		56-74	0,80	B6S	3510	-	-
6.0 hp		65-76	0,80	B6S	3510	-	-
6.0 hp		78-78	-	BUHW-2	5626	-	-
6.0 hp - 2 temps		77-98	0,80	BR6HS	3922	BR6HIX	3419
6.0 hp - 4 temps OHC 128cc		97-03	0,70	D6HA	6512	-	-
6.0 hp - 6R, 6RL		71-76	0,80	B6S	3510	-	-
6.0 hp - Fisherman		56-74	0,80	B6S	3510	-	-
6.5 hp - COM		81-93	0,80	BR6HS	3922	BR6HIX	3419
7.5 hp		52-58	0,80	B6S	3510	-	-
7.5 hp		77-97	0,80	BR6HS	3922	BR6HIX	3419
7.5 hp - COM		77-03	0,80	BZ7HS-10	3579	-	-
8.0 hp - 2 temps / COM		77-98	0,80	BR6HS	3922	BR6HIX	3419
8.0 hp - 4 temps OHC 211cc		96-03	0,80	D6HA	6512	-	-
9.0 hp - 9R, 9RL, 9EL		74-	0,80	BZ7HS-10	3579	-	-
9.5 hp		52-73	0,80	B6S	3510	-	-
9.5 hp - Sportwin		56-73	0,80	B6S	3510	-	-
9.7 hp		42-49	0,80	AB-6	2910	-	-
9.9 hp		74-76	0,80	B7HS	5110	BR7HIX	7067

	Modèle	Cyl.				N° STOCK		N° STOCK IX
9.9 hp			78-79	-	BUHW-2	5626	-	-
9.9 hp - 2 temps			77-01	0,80	BR7HS	4122	BR7HIX	7067
9.9 hp - 4 temps 211cc			96-98	0,70	D6HA	6512	-	-
9.9 hp - 4 temps OHC 302cc			02-03	0,80	DCPR7E	3932	DCPR7EIX	6046
9.9 hp - 4 temps OHC 305cc			95-03	0,80	DCPR7E	3932	DCPR7EIX	6046
9.9 hp - Big Bore			93-06	0,80	BR6HS	3922	BR6HIX	3419
10 hp			52-58	0,80	B6S	3510	-	-
10 hp			59-63	0,80	B7S	3710	-	-
10 hp - 10E, 10EL, 10R, 10RL			75-76	0,80	BZ7HS-10	3579	-	-
10 hp - COM			81-82	-	BUHW-2	5626	-	-
10 hp - COM			92-93	0,80	BZ7HS-10	3579	-	-
10 hp - COM			94-03	0,80	BR7HS	4122	BR7HIX	7067
10 hp - Sportwin			56-73	0,80	B6S	3510	-	-
14 hp			50-72	0,80	B6S	3510	-	-
14 hp			88-89	0,80	BZ7HS-10	3579	-	-
14 hp - COM			81-	-	BUHW-2	5626	-	-
14 hp - COM			81-91	0,80	BZ7HS-10	3579	-	-
15 hp			56-58	0,80	B6S	3510	-	-
15 hp			74-76	0,80	B7HS	5110	BR7HIX	7067
15 hp			77-92	0,80	BZ7HS-10	3579	-	-
15 hp - 2 temps			94-98	0,80	BR7HS	4122	BR7HIX	7067
15 hp - 4 temps OHC 305cc			95-03	0,80	DCPR7E	3932	DCPR7EIX	6046
15 hp - 15E, 15EL, 15R, 15RL			74-76	0,80	BZ7HS-10	3579	-	-
15 hp - COM			92-93	0,80	BZ7HS-10	3579	-	-
15 hp - COM			94-01	0,80	BR7HS	4122	BR7HIX	7067
15 hp - Kero			95-98	0,80	BUHXW-1	5526	-	-
15hp - E15DHPLIIC / E15DHPLIIB			11-	1,10	IZFR6N-E	4757	-	-
15hp - E15DHPLINR			12-	1,10	IZFR6N-E	4757	-	-
15hp - E15DHPLISS			00-	1,10	IZFR6N-E	4757	-	-
15hp - E15DHTLIIC / E15DHTLIIB			11-	1,10	IZFR6N-E	4757	-	-
15hp - E15DHTLINR			12-	1,10	IZFR6N-E	4757	-	-
15hp - E15DHTLISS			00-	1,10	IZFR6N-E	4757	-	-
15hp - E15HPSLIIB / E15HPSLIIS			11-	1,10	IZFR6N-E	4757	-	-
15hp - E15HPSLINC / E15HPSXINC			12-	1,10	IZFR6N-E	4757	-	-
15hp - E15HTSLIIB / E15HTSLIIS			11-	1,10	IZFR6N-E	4757	-	-
15hp - E15HTSLINC / E15HTSXINC			12-	1,10	IZFR6N-E	4757	-	-
18 hp			50-73	0,80	B6S	3510	-	-
18 hp - Fastwin			57-73	0,80	B8S	3810	-	-
18 hp - Jet 2 cyl.	2		95-98	0,80	BR7HS	4122	BR7HIX	7067
20 hp			66-73	0,80	B6S	3510	-	-
20 hp			78-93	0,80	BR7HS	4122	BR7HIX	7067
20 hp - 2 cyl.	2		78-98	0,80	BR7HS	4122	BR7HIX	7067
20 hp - 20R, 20RL			73-	0,80	B6S	3510	-	-
20 hp - 20R, 25R			69-72	0,80	B6S	3510	-	-
20 hp - 20RL, 25RL			71-72	0,80	B6S	3510	-	-
25 hp			52-55	0,80	B6S	3510	-	-
25 hp			69-76	0,80	B6S	3510	-	-
25 hp			77-	0,80	BR7HS	4122	BR7HIX	7067
25 hp - 2 cyl.	2		77-98	0,80	BR7HS	4122	BR7HIX	7067
25 hp - 3 cyl.	3		95-98	0,80	BR6HS	3922	BR6HIX	3419
25 hp - 4 temps			00-01	0,80	DCPR7E	3932	DCPR7EIX	6046
25 hp - 20R, 25R			69-72	0,80	B6S	3510	-	-
25 hp - 20RL, 25RL			71-72	0,80	B6S	3510	-	-
25 hp - 25E, 25EL			72-76	0,80	B6S	3510	-	-
25 hp - 25R, 25RL			73-76	0,80	B6S	3510	-	-
25 hp - Bigwin			51-70	0,80	B8S	3810	-	-
25 hp - COM			81-98	-	BUHXW-1	5526	-	-
25 hp - Commercial			99-01	-	BUHXW-1	5526	-	-
25 hp - Evinrude 25			78-93	0,80	BZ7HS-10	3579	-	-
25 hp - E25DELIIB / E25DELIIR			11-	1,10	IZFR6N-E	4757	-	-
25 hp - E25DELINA			12-	1,10	IZFR6N-E	4757	-	-
25 hp - E25DELISC			10-	1,10	IZFR6N-E	4757	-	-
25 hp - E25DELSSES			09-	1,10	IZFR6F11	4095	-	-
25 hp - E25DPLIIG / E25DPLIIB / E25DPLIIR			11-	1,10	IZFR6N-E	4757	-	-
25 hp - E25DPLINA			12-	1,10	IZFR6N-E	4757	-	-
25 hp - E25DPLISC			10-	1,10	IZFR6N-E	4757	-	-
25 hp - E25DPLSES			09-	1,10	IZFR6F11	4095	-	-
25 hp - E25DPSLIIB / E25DPSLIIS			11-	1,10	IZFR6N-E	4757	-	-
25 hp - E25DPSLINC			12-	1,10	IZFR6N-E	4757	-	-
25 hp - E25DRIIB / E25DRIIR			11-	1,10	IZFR6N-E	4757	-	-
25 hp - E25DRINA			12-	1,10	IZFR6N-E	4757	-	-
25 hp - E25DRISC			10-	1,10	IZFR6N-E	4757	-	-
25 hp - E25DRLIIB / E25DRLIIR			11-	1,10	IZFR6N-E	4757	-	-
25 hp - E25DRLINA			12-	1,10	IZFR6N-E	4757	-	-
25 hp - E25DRLISC			10-	1,10	IZFR6N-E	4757	-	-

EVINRUDE





Modèle

Cyl.

 N°
STOCK

 N°
STOCK IX

25 hp - E25DRLES		09-	1,10	IZFR6F11	4095	-	-
25 hp - E25DRSIH / E25DRSIIS		11-	1,10	IZFR6N-E	4757	-	-
25 hp - E25DRSINC / E25DRSLINC		12-	1,10	IZFR6N-E	4757	-	-
25 hp - E25DRSLIH / E25DRSLIS		11-	1,10	IZFR6N-E	4757	-	-
25 hp - E25DRSES		09-	1,10	IZFR6F11	4095	-	-
25 hp - E25DTEIG / E25DTEIH / E25TEIIR		11-	1,10	IZFR6N-E	4757	-	-
25 hp - E25DTEINA		12-	1,10	IZFR6N-E	4757	-	-
25 hp - E25DTEISC		10-	1,10	IZFR6N-E	4757	-	-
25 hp - E25DTELIH / E25DTELIIR		11-	1,10	IZFR6N-E	4757	-	-
25 hp - E25DTELINA		12-	1,10	IZFR6N-E	4757	-	-
25 hp - E25DTELISC		10-	1,10	IZFR6N-E	4757	-	-
25 hp - E25DTELSSES / E25DTESES		09-	1,10	IZFR6F11	4095	-	-
25 hp - E2525DTLIH / E25DTLIIR		11-	1,10	IZFR6N-E	4757	-	-
25 hp - E25DTLINA		12-	1,10	IZFR6N-E	4757	-	-
25 hp - E25DTLISC		10-	1,10	IZFR6N-E	4757	-	-
25 hp - E25DTLSSES		09-	1,10	IZFR6F11	4095	-	-
25 hp - E25DTSLIH / E25DTSLIS		11-	1,10	IZFR6N-E	4757	-	-
25 hp - E25DTSLINC / E25TESLINC		12-	1,10	IZFR6N-E	4757	-	-
25 hp - E25TESLIH / E25TESLIIS		11-	1,10	IZFR6N-E	4757	-	-
28 hp		62-64	0,80	B6S	3510	-	-
28 hp		78-97	0,80	BR7HS	4122	BR7HIX	7067
28 hp - 28 Jet		92-03	0,80	BPZ8HS-10	3133	-	-
30 hp		56-71	0,80	B6S	3510	-	-
30 hp		78-98	0,80	BR7HS	4122	BR7HIX	7067
30 hp		00-03	0,80	DCPR7E	3932	DCPR7EIX	6046
30 hp - Bigwin		51-70	0,80	B8S	3810	-	-
30 hp - E30DELIH / E30DELIIR		11-	1,10	IZFR6N-E	4757	-	-
30 hp - E30DELINA		12-	1,10	IZFR6N-E	4757	-	-
30 hp - E30DELISC		10-	1,10	IZFR6N-E	4757	-	-
30 hp - E30DELSES		09-	1,10	IZFR6F11	4095	-	-
30 hp - E30DPLIH / E30DPLIIR		11-	1,10	IZFR6N-E	4757	-	-
30 hp - E30DPLINA		12-	1,10	IZFR6N-E	4757	-	-
30 hp - E30DPLISC		10-	1,10	IZFR6N-E	4757	-	-
30 hp - E30DPLSES		09-	1,10	IZFR6F11	4095	-	-
30 hp - E30DPSLIH / E30DPSLIIS		11-	1,10	IZFR6N-E	4757	-	-
30 hp - E30DPSLINC		12-	1,10	IZFR6N-E	4757	-	-
30 hp - E30DRIIG / E30DRIIH / E30DRIIR		11-	1,10	IZFR6N-E	4757	-	-
30 hp - E30DRINA		12-	1,10	IZFR6N-E	4757	-	-
30 hp - E30DRISC		10-	1,10	IZFR6N-E	4757	-	-
30 hp - E30DRLIIG / E30DRLIH / E30DRLIIR		11-	1,10	IZFR6N-E	4757	-	-
30 hp - E30DRLINA		12-	1,10	IZFR6N-E	4757	-	-
30 hp - E30DRLISC		10-	1,10	IZFR6N-E	4757	-	-
30 hp - E30DRLSES / E30DRSES		09-	1,10	IZFR6F11	4095	-	-
30 hp - E30DRSIH / E30DRSIIS		11-	1,10	IZFR6N-E	4757	-	-
30 hp - E30DRSINC		12-	1,10	IZFR6N-E	4757	-	-
30 hp - E30DRSLIH / E30DRSLIS		11-	1,10	IZFR6N-E	4757	-	-
30 hp - E30DRSLINC		12-	1,10	IZFR6N-E	4757	-	-
30 hp - E30DTELIH / E30DTELIIR		11-	1,10	IZFR6N-E	4757	-	-
30 hp - E30DTELINA		12-	1,10	IZFR6N-E	4757	-	-
30 hp - E30DTELISC		10-	1,10	IZFR6N-E	4757	-	-
30 hp - E30DTELSSES		09-	1,10	IZFR6F11	4095	-	-
30 hp - E30DTLIH / E30DTLIIR		11-	1,10	IZFR6N-E	4757	-	-
30 hp - E30DTLINA		12-	1,10	IZFR6N-E	4757	-	-
30 hp - E30DTLISC		10-	1,10	IZFR6N-E	4757	-	-
30 hp - E30DTLSSES		09-	1,10	IZFR6F11	4095	-	-
30 hp - E30DTSLIH / E30DTSLIS		11-	1,10	IZFR6N-E	4757	-	-
30 hp - E30DTSLINC / E30TESLINC		12-	1,10	IZFR6N-E	4757	-	-
30 hp - E30TESLIH / E30TESLIIS		11-	1,10	IZFR6N-E	4757	-	-
33 hp		65-71	0,80	B6S	3510	-	-
35 hp		76-	0,80	BZ7HS-10	3579	-	-
35 hp		93-01	0,80	BPZ8HS-10	3133	-	-
35 hp - 2 cyl.	2	57-59	0,80	B6S	3510	-	-
35 hp - 2 cyl.	2	95-01	0,80	BR6HS	3922	BR6HIX	3419
35 hp - 4 temps		77-97	0,80	BZ7HS-10	3579	-	-
35 hp - Bigwin		51-70	0,80	B8S	3810	-	-
40 hp		56-73	0,80	B6S	3510	-	-
40 hp		74-76	0,80	B7HS	5110	BR7HIX	7067
40 hp		99-03	0,80	DCPR7E	3932	DCPR7EIX	6046
40 hp - 2 cyl.	2	80-88	0,80	BZ7HS-10	3579	-	-
40 hp - 2 cyl.	2	89-98	0,80	BPZ8HS-10	3133	-	-
40 hp - 3 cyl.	3	84-03	-	BUHXW-1	5526	-	-
40 hp - Bigwin		51-70	0,80	B8S	3810	-	-
40 hp - COM43 cid		81-90	0,80	B7HS	5110	BR7HIX	7067
40 hp - E-Tec		04-05	0,80	PZFR6H	7696	-	-
40 hp - E-Tec 40 Inline 2		06-08	0,80	IZFR6N-E	4757	-	-

Modèle	Cyl.	0201			N° STOCK		N° STOCK IX
40 hp - 40E, 40EL, 40R, 40RL		69-73	0,80	B6S	3510	-	-
40 hp - 40E, 40EL, 40R, 40RL		74-	0,80	BZ7HS-10	3579	-	-
40 hp - 40E, 40EL, 40R, 40RL		75-76	0,80	BZ7HS-10	3579	-	-
40 hp - E40DELSDA		06-	0,80	IZFR6N-E	4757	-	-
40 hp - E40DELSOR		05-	0,80	PZFR6H	7696	-	-
40 hp - E40DHLSN / E40DHLSLN		12-	1,10	IZFR6N-E	4757	-	-
40 hp - E40DP		08-	1,10	IZFR6F11	4095	-	-
40 hp - E40DPLIS		11-	1,10	IZFR6N-E	4757	-	-
40 hp - E40DPLINC		12-	1,10	IZFR6N-E	4757	-	-
40 hp - E40DPLISD / E40DPLISF		10-	1,10	IZFR6N-E	4757	-	-
40 hp - E40DPLSDA		06-	0,80	IZFR6N-E	4757	-	-
40 hp - E40DPLSEE		09-	1,10	IZFR6F11	4095	-	-
40 hp - E40DPLSOR		05-	0,80	PZFR6H	7696	-	-
40 hp - E40DPLSUM		07-	0,80	IZFR6N-E	4757	-	-
40 hp - E40DRLIS		11-	1,10	IZFR6N-E	4757	-	-
40 hp - E40DRLINC		12-	1,10	IZFR6N-E	4757	-	-
40 hp - E40DRLISD / E40DRLISF		10-	1,10	IZFR6N-E	4757	-	-
40 hp - E40DRLSDA		06-	0,80	IZFR6N-E	4757	-	-
40 hp - E40DRLSEE		09-	1,10	IZFR6F11	4095	-	-
40 hp - E40DRLSOR		05-	0,80	PZFR6H	7696	-	-
40 hp - E40DRLSUM		07-	0,80	IZFR6N-E	4757	-	-
40 hp - E40DRLSCB		08-	1,10	IZFR6F11	4095	-	-
40 hp - E40DSLIIA		11-	1,10	IZFR6N-E	4757	-	-
40 hp - E40DSLINM		12-	1,10	IZFR6N-E	4757	-	-
40 hp - E40DSLSCS		08-	1,10	IZFR6F11	4095	-	-
40 hp - E40DSLSEC		09-	1,10	IZFR6F11	4095	-	-
40 hp - E40DTLIIA		11-	1,10	IZFR6N-E	4757	-	-
40 hp - E40DTLINM		12-	1,10	IZFR6N-E	4757	-	-
40 hp - E40DTLISF / E40DTLISR		10-	1,10	IZFR6N-E	4757	-	-
40 hp - E40DTLSCS		08-	1,10	IZFR6F11	4095	-	-
45 hp - COM		86-90	-	BUZHW-2	2173	-	-
45 hp - COM		91-03	-	BUHXW-1	5526	-	-
48 hp - 2 cyl.	2	80-88	0,80	BZ7HS-10	3579	-	-
48 hp - 2 cyl.	2	89-97	0,80	BPZ8HS-10	3133	-	-
50 hp		58-59	0,80	B6S	3510	-	-
50 hp		71-75	0,80	BZ7HS-10	3579	-	-
50 hp		78-79	0,80	B7HS	5110	BR7HIX	7067
50 hp - 2 cyl.	2	80-88	0,80	BZ7HS-10	3579	-	-
50 hp - 2 cyl.	2	89-98	0,80	BPZ8HS-10	3133	-	-
50 hp - 3 cyl.	3	95-98	0,80	BPZ8HS-10	3133	-	-
50 hp - 4 Temps DOHC 815cc		99-03	0,80	DCPR7E	3932	DCPR7EIX	6046
50 hp - E-Tec		04-05	0,80	PZFR6H	7696	-	-
50 hp - E-Tec 50 Inline 2		06-08	0,80	IZFR6N-E	4757	-	-
50 hp - E50DPLIS		11-	1,10	IZFR6N-E	4757	-	-
50 hp - E50DPLISD / E50DPLISF		10-	1,10	IZFR6N-E	4757	-	-
50 hp - E50DPLSCB		08-	1,10	IZFR6F11	4095	-	-
50 hp - E50DPLSDA		06-	0,80	IZFR6N-E	4757	-	-
50 hp - E50DPLSEE		09-	1,10	IZFR6F11	4095	-	-
50 hp - E50DPLSOR		05-	0,80	PZFR6H	7696	-	-
50 hp - E50DPLSUM		07-	0,80	IZFR6N-E	4757	-	-
50 hp - E50DSLIIA		11-	1,10	IZFR6N-E	4757	-	-
50 hp - E50DSLINM		12-	1,10	IZFR6N-E	4757	-	-
50 hp - E50DSLISF / E50DSLISR		10-	1,10	IZFR6N-E	4757	-	-
50 hp - E50DSLSCS		08-	1,10	IZFR6F11	4095	-	-
50 hp - E50DSLSEC		09-	1,10	IZFR6F11	4095	-	-
50 hp - E50DTLIIA		11-	1,10	IZFR6N-E	4757	-	-
50 hp - E50DTLINM		12-	1,10	IZFR6N-E	4757	-	-
50 hp - E50DTLISF / E50DTLISR		10-	1,10	IZFR6N-E	4757	-	-
50 hp - E50DTLSCS		08-	1,10	IZFR6F11	4095	-	-
50 hp - E50DTLSEC		09-	1,10	IZFR6F11	4095	-	-
50 hp - E50DPLINC		12-	1,10	IZFR6N-E	4757	-	-
50 hp - E50DPLSDA		06-	0,80	IZFR6N-E	4757	-	-
50 hp - E50DPLSUM		07-	0,80	IZFR6N-E	4757	-	-
55 hp - 2 cyl.	2	76-89	0,80	B7HS	5110	BR7HIX	7067
55 hp - 3 cyl.	3	68-69	0,80	BZ7HS-10	3579	-	-
55 hp - COM		86-03	-	BUHXW-1	5526	-	-
55 hp - COM 2 cyl.	2	94-95	0,80	BPZ8HS-10	3133	-	-
55 hp - E55MJRLIIM		11-	1,10	IZFR6N-E	4757	-	-
55 hp - E55MJRLINB		12-	1,10	IZFR6N-E	4757	-	-
55 hp - E55MJRLISA		10-	1,10	IZFR6N-E	4757	-	-
55 hp - E55MJRLSCC		08-	1,10	IZFR6F11	4095	-	-
55 HP - E55MJRLSEF		09-	1,10	IZFR6N-E	4757	-	-
55 hp - E55MJRLSER		09-	1,10	IZFR6F11	4095	-	-
55 hp - E55MRLIIM		11-	1,10	IZFR6N-E	4757	-	-
55 hp - E55MRLINB		12-	1,10	IZFR6N-E	4757	-	-



Modèle

Cyl.







N° STOCK







N° STOCK IX

55 hp - E55MRLISA		10-	1,10	IZFR6N-E	4757	-	-
55 hp - E55MRLSCC		08-	1,10	IZFR6F11	4095	-	-
55 HP - E55MRLSEF		09-	1,10	IZFR6N-E	4757	-	-
55 hp - E55MRLSER		09-	1,10	IZFR6F11	4095	-	-
55 hp - Surper Six-O		71-	-	BUHW	2622	-	-
60 hp - 2 cyl.	2	80-85	0,80	BZ7HS-10	3579	-	-
60 hp - 3 cyl. 49 cid	3	75-89	0,80	BZ7HS-10	3579	-	-
60 hp - 3 cyl. 56 cid	3	89-93	0,80	BZ7HS-10	3579	-	-
60 hp - 3 cyl. 56 cid	3	94-98	0,80	BPZ8HS-10	3133	-	-
60 hp - 4 temps OHC		02-03	0,90	BPR6ES	7822	BPR6EIX	6637
60 hp - E-Tec		05-	0,80	PZFR6H	7696	-	-
60 hp - E-Tec 60 Inline 2		06-08	0,80	IZFR6N-E	4757	-	-
60 hp - E60DPLIIS		11-	1,10	IZFR6N-E	4757	-	-
60 hp - E60DPLINC		12-	1,10	IZFR6N-E	4757	-	-
60 hp - E60DPLISD / E60DPLISF		10-	1,10	IZFR6N-E	4757	-	-
60 hp - E60DPLSEE		09-	1,10	IZFR6F11	4095	-	-
60 hp - E60DPLSCB		08-	1,10	IZFR6F11	4095	-	-
60 hp - E60DPLSDA		06-	0,80	IZFR6N-E	4757	-	-
60 hp - E60DPLSUM		07-	0,80	IZFR6N-E	4757	-	-
60 hp - E60DSLIIA		11-	1,10	IZFR6N-E	4757	-	-
60 hp - E60DSLINM		12-	1,10	IZFR6N-E	4757	-	-
60 hp - E60DSLISF / E60DSLISR		10-	1,10	IZFR6N-E	4757	-	-
60 hp - E60DSLSCS		08-	1,10	IZFR6F11	4095	-	-
60 hp - E60DSLSEC		09-	1,10	IZFR6F11	4095	-	-
60 hp - E60DTLIIA		11-	1,10	IZFR6N-E	4757	-	-
60 hp - E60DTLINM		12-	1,10	IZFR6N-E	4757	-	-
60 hp - E60DTLISF / E60DTLISR		10-	1,10	IZFR6N-E	4757	-	-
60 hp - E60DTLSCS		08-	1,10	IZFR6F11	4095	-	-
60 hp - E60DTLSEC		09-	1,10	IZFR6F11	4095	-	-
60 hp - E60WDRLSOS / E60WDRYOS		05-	0,80	PZFR6H	7696	-	-
60 hp - Surper Six-O		71-	-	BUHW	2622	-	-
60 hp - Triumph 3 cyl.	3	70-71	-	BUHW	2622	-	-
60 hp - V4	4	64-67	0,80	B6S	3510	-	-
65 hp		98-01	-	BUHXW-1	5526	-	-
65 hp - 3 cyl.	3	-93	0,80	BZ7HS-10	3579	-	-
65 hp - COM 3 cyl.	3	94-95	0,80	BPZ8HS-10	3133	-	-
65 hp - COM HC LC		84-87	0,80	BZ7HS-10	3579	-	-
65 hp - COM HC LC		88-97	-	BUHXW-1	5526	-	-
65 hp - CV4 65 Jet		92-97	0,80	BR7HS	4122	BR7HIX	7067
65 hp - E65WDRLLIA		11-	1,10	IZFR6N-E	4757	-	-
65 hp - E65WDRLLINM		12-	1,10	IZFR6N-E	4757	-	-
65 hp - E65WDRLLISF / E65WDRLLISR		10-	1,10	IZFR6N-E	4757	-	-
65 hp - E65WDRLLSCS		08-	1,10	IZFR6F11	4095	-	-
65 hp - E65WDRLLSEC		09-	1,10	IZFR6F11	4095	-	-
65 hp - E65WDRYIIA		11-	1,10	IZFR6N-E	4757	-	-
65 hp - E65WDRYINM		12-	1,10	IZFR6N-E	4757	-	-
65 hp - E65WDRYISF / E65WDRYISR		10-	1,10	IZFR6N-E	4757	-	-
65 hp - E65WDRYSCS		08-	1,10	IZFR6F11	4095	-	-
65 hp - E65WDRYSEC		09-	1,10	IZFR6F11	4095	-	-
65 hp - Triumph 3 cyl.	3	72-73	0,80	B7HS	5110	BR7HIX	7067
65 hp - V4 Sportfour		68-	0,80	BZ7HS-10	3579	-	-
70 hp - 3 cyl. 49 cid	3	75-89	0,80	BZ7HS-10	3579	-	-
70 hp - 3 cyl. 56 cid	3	89-93	0,80	BZ7HS-10	3579	-	-
70 hp - 3 cyl. 56 cid	3	94-98	0,80	BPZ8HS-10	3133	-	-
70 hp - 3 cyl. Backtroller	3	94-97	0,80	BPR7HS	6422	BPR7HIX	5944
70 hp - 4 temps OHC 1298cc		98-03	0,90	BPR6ES	7822	BPR6EIX	6637
75 hp		75-88	0,80	B7HS-10	2129	-	-
75 hp		01-05	0,80	BKR5EK	7956	BKR5EIX	6341
75 hp - E-TEC		04-05	0,80	PZFR6H	7696	-	-
75 hp - E-TEC		06-	0,80	IZFR6N-E	4757	-	-
75 hp - E75DPLIIS		11-	1,10	IZFR6N-E	4757	-	-
75 hp - E75DPLINC		12-	1,10	IZFR6N-E	4757	-	-
75 hp - E75DPLISD / E75DPLISF		10-	1,10	IZFR6N-E	4757	-	-
75 hp - E75DPLSCB		08-	1,10	IZFR6F11	4095	-	-
75 hp - E75DPLSDA		06-	0,80	IZFR6N-E	4757	-	-
75 hp - E75DPLSEE		09-	1,10	IZFR6F11	4095	-	-
75 hp - E75DPLSOR		05-	0,80	PZFR6H	7696	-	-
75 hp - E75DPLSUM		07-	0,80	IZFR6N-E	4757	-	-
75 hp - E75DSLIIA		11-	1,10	IZFR6N-E	4757	-	-
75 hp - E75DSLINM		12-	1,10	IZFR6N-E	4757	-	-
75 hp - E75DSLISF / E75DSLISR		10-	1,10	IZFR6N-E	4757	-	-
75 hp - E75DSLSCS		08-	1,10	IZFR6F11	4095	-	-
75 hp - E75DSLSEC		09-	1,10	IZFR6F11	4095	-	-
75 hp - V4	4	60-65	0,80	B6S	3510	-	-
80 hp		66-67	0,80	B6S	3510	-	-

 Modèle	Cyl.				N° STOCK		N° STOCK IX
80 hp - Jet CV4		79-98	0,80	BR7HS	4122	BR7HIX	7067
80 hp - Starfire		66-67	0,80	B8S	3810	-	-
85 hp		68-80	0,80	B7HS	5110	BR7HIX	7067
85 hp		86-93	0,80	BZ7HS-10	3579	-	-
85 hp - V4 Backtroller	4	94-95	0,80	BR7HS	4122	BR7HIX	7067
88 hp - SPL CV4		79-97	0,80	BR7HS	4122	BR7HIX	7067
90 hp		64-65	0,80	B6S	3510	-	-
90 hp		01-05	0,80	BKR5EK	7956	BKR5EIX	6341
90 hp - 1950cc	4	03-	0,80	BKR6E	6962	BKR6EIX	6418
90 hp - CV4		79-98	0,80	BR7HS	4122	BR7HIX	7067
90 hp - E-Tec		04-05	0,80	PZFR6H	7696	-	-
90 hp - E-Tec 1.3L I3		06-08	0,80	IZFR6N-E	4757	-	-
90 hp - E90DMXSES		09-	0,80	IZFR6N-E	4757	-	-
90 hp - E90DPLIIS		11-	0,80	IZFR6N-E	4757	-	-
90 hp - E90DPLINC		12-	0,80	IZFR6N-E	4757	-	-
90 hp - E90DPLISD / E90DPLISF		10-	0,80	IZFR6N-E	4757	-	-
90 hp - E90DPLSCB		08-	1,10	IZFR6F11	4095	-	-
90 hp - E90DPLSDA		06-	0,80	IZFR6N-E	4757	-	-
90 hp - E90DPLSEE		09-	1,10	IZFR6F11	4095	-	-
90 hp - E90DPLSOR		05-	0,80	PZFR6H	7696	-	-
90 hp - E90DPLSUM		07-	0,80	IZFR6N-E	4757	-	-
90 hp - E90DPXIIS		11-	0,80	IZFR6N-E	4757	-	-
90 hp - E90DXLINC		12-	0,80	IZFR6N-E	4757	-	-
90 hp - E90DPXISD / E90DPXISF		10-	0,80	IZFR6N-E	4757	-	-
90 hp - E90DPXSCB		08-	1,10	IZFR6F11	4095	-	-
90 hp - E90DPXSDA		06-	0,80	IZFR6N-E	4757	-	-
90 hp - E90DPXSEE		09-	1,10	IZFR6F11	4095	-	-
90 hp - E90DPXSOR		05-	0,80	PZFR6H	7696	-	-
90 hp - E90DPXSUM		07-	0,80	IZFR6N-E	4757	-	-
90 hp - E90DSLID		11-	0,80	IZFR6N-E	4757	-	-
90 hp - E90DSLINC		12-	0,80	IZFR6N-E	4757	-	-
90 hp - E90DSLISE / E90DSLISF		10-	0,80	IZFR6N-E	4757	-	-
90 hp - E90DSLSCM		08-	1,10	IZFR6F11	4095	-	-
90 hp - E90DSLSDR		06-	0,80	IZFR6N-E	4757	-	-
90 hp - E90DSLSEB		09-	1,10	IZFR6F11	4095	-	-
90 hp - E90DSLSOC		05-	0,80	PZFR6H	7696	-	-
90 hp - E90DSLSUM		07-	0,80	IZFR6N-E	4757	-	-
90 hp - E90WDELIIA		11-	0,80	IZFR6N-E	4757	-	-
90 hp - E90WDELINM		12-	0,80	IZFR6N-E	4757	-	-
90 hp - E90WDELISF / E90WDELISR		10-	0,80	IZFR6N-E	4757	-	-
90 hp - E90WDELSCS		08-	1,10	IZFR6F11	4095	-	-
90 hp - E90WDELSEC		09-	1,10	IZFR6F11	4095	-	-
90 hp - E90WDEXIIA		11-	0,80	IZFR6N-E	4757	-	-
90 hp - E90WDEXINM		12-	0,80	IZFR6N-E	4757	-	-
90 hp - E90WDEXISF / E90WDEXISR		10-	0,80	IZFR6N-E	4757	-	-
90 hp - E90WDEXSCS		08-	1,10	IZFR6F11	4095	-	-
90 hp - E90WDEXSEC		09-	1,10	IZFR6F11	4095	-	-
90 hp - E90WDPLSOS		05-	0,80	PZFR6H	7696	-	-
90 hp - LV4		95-98	0,80	BPZ8HS-10	3133	-	-
90 hp - LV4 F.F.I.		98-00	0,80	PZFR6H	7696	-	-
90 hp - Turbojet CV4		94-97	0,80	BR7HS	4122	BR7HIX	7067
100 hp		66-	0,80	B6S	3510	-	-
100 hp		99-01	0,80	BZ7HS-10	3579	-	-
100 hp		04-05	0,80	BKR5EK	7956	BKR5EIX	6341
100 hp - 4 cyl DI	4	04-05	0,80	PZFR6H	7696	-	-
100 hp - COM		84-98	-	BUHXW-1	5526	-	-
100 hp - E100FPLSOC / E100FSLSOC		05-	1,10	PZFR6F-11	3271	-	-
100 hp - Starfire		67-72	0,80	B7HS	5110	BR7HIX	7067
100 hp - V4		79-80	0,80	B7HS	5110	BR7HIX	7067
105 hp - 105 Jet LV6	6	93-03	0,80	BPZ8HS-10	3133	-	-
105 hp - COM LV4	4	97-03	0,80	BPZ8HS-10	3133	-	-
110 / 112 hp - CV4	4	79-97	0,80	BR7HS	4122	BR7HIX	7067
115 hp		69-70	0,80	B7HS	5110	BR7HIX	7067
115 hp		73-79	0,80	BZ7HS-10	3579	-	-
115 hp		85-	-	BUHXW-1	5526	-	-
115 hp		86-93	0,80	BZ7HS-10	3579	-	-
115 hp		04-05	0,80	BKR5EK	7956	BKR5EIX	6341
115 hp - COM		75-84	0,80	BZ7HS-10	3579	-	-
115 hp - CV4	4	79-98	0,80	BR7HS	4122	BR7HIX	7067
115 hp - E-Tec 1.7L V4	4	07-08	0,80	IZFR6N-E	4757	-	-
115 hp - E115DBXIIB		11-	1,10	IZFR6N-E	4757	-	-
115 hp - E115DBXINE		12-	1,10	IZFR6N-E	4757	-	-
115 hp - E115DBXISF / E115DBXISM		10-	1,10	IZFR6N-E	4757	-	-
115 hp - E115DBXSCR		08-	1,10	IZFR6F11	4095	-	-
115 hp - E115DBXSEF		09-	1,10	IZFR6F11	4095	-	-

EVINRUDE

	Modèle	Cyl.				N° STOCK		N° STOCK IX
115 hp - E115DBXSUC			07-	0,80	IZFR6N-E	4757	-	-
115 hp - E115DCXIA			11-	1,10	IZFR6N-E	4757	-	-
115 hp - E115DCXINM			12-	1,10	IZFR6N-E	4757	-	-
115 hp - E115DCXISF / E115DCXISR			10-	1,10	IZFR6N-E	4757	-	-
115 hp - E115DCXSCS			08-	1,10	IZFR6F11	4095	-	-
115 hp - E115DCXSEF			09-	1,10	IZFR6F11	4095	-	-
115 hp - E115DHLIIR			11-	1,10	IZFR6N-E	4757	-	-
115 hp - E115DHLINA			12-	1,10	IZFR6N-E	4757	-	-
115 hp - E115DHLISC			10-	1,10	IZFR6N-E	4757	-	-
115 hp - E115DHLSES			09-	1,10	IZFR6F11	4095	-	-
115 hp - E115DHIIR			11-	1,10	IZFR6N-E	4757	-	-
115 hp - E115DXINA			12-	1,10	IZFR6N-E	4757	-	-
115 hp - E115DXISC / E115DXISF			10-	1,10	IZFR6N-E	4757	-	-
115 hp - E115DXSES			09-	1,10	IZFR6F11	4095	-	-
115 hp - E115DPLIIB			11-	1,10	IZFR6N-E	4757	-	-
115 hp - E115DPLINE			12-	1,10	IZFR6N-E	4757	-	-
115 hp - E115DPLISF / E115DPLISM			10-	1,10	IZFR6N-E	4757	-	-
115 hp - E115DPLSCR			08-	1,10	IZFR6F11	4095	-	-
115 hp - E115DPLSEF			09-	1,10	IZFR6F11	4095	-	-
115 hp - E115DPLSUC			07-	0,80	IZFR6N-E	4757	-	-
115 hp - E115DPXIIB			11-	1,10	IZFR6N-E	4757	-	-
115 hp - E115DPXINE			12-	1,10	IZFR6N-E	4757	-	-
115 hp - E115DPXISF / E115DPXISM			10-	1,10	IZFR6N-E	4757	-	-
115 hp - E115DPXSCR			08-	1,10	IZFR6F11	4095	-	-
115 hp - E115DPXSEF			09-	1,10	IZFR6F11	4095	-	-
115 hp - E115DPXSUC			07-	0,80	IZFR6N-E	4757	-	-
115 hp - E115DSLIIIB / E115DSLIIIR			11-	1,10	IZFR6N-E	4757	-	-
115 hp - E115DPLINE			12-	1,10	IZFR6N-E	4757	-	-
115 hp - E115DSLISF / E115DSLISM			10-	1,10	IZFR6N-E	4757	-	-
115 hp - E115DSLSCR			08-	1,10	IZFR6F11	4095	-	-
115 hp - E115DSLSEF			09-	1,10	IZFR6F11	4095	-	-
115 hp - E115DLSLSC			07-	0,80	IZFR6N-E	4757	-	-
115 hp - E115FPLSDS / E115FPXSDS / E115FSLSDS			06-	1,10	PZFR6F-11	3271	-	-
115 hp - E115FPLSOD / E115FPXSOD / E115FSLSOD			05-	1,10	PZFR6F-11	3271	-	-
115 hp - E115HSLINA			12-	1,10	IZFR6N-E	4757	-	-
115 hp - E115HSLISC / E115HSLISF			10-	1,10	IZFR6N-E	4757	-	-
115 hp - E115HSLSES			09-	1,10	IZFR6F11	4095	-	-
115 hp - Intruder LV4			95-98	0,80	BPZ8HS-10	3133	-	-
115 hp - LV4 F.F.I.			98-03	0,80	PZFR6H	7696	-	-
115 hp - Turbojet CV4			94-98	0,80	BR7HS	4122	BR7HIX	7067
115 hp - X-115			67-68	-	BUHW	2622	-	-
120 hp - LV4	4		85-03	0,80	BPZ8HS-10	3133	-	-
125 hp			71-72	0,80	B7HS	5110	BR7HIX	7067
130 hp - LV4	4		85-03	0,80	BPZ8HS-10	3133	-	-
130 hp - E130DCXIIR			11-	1,10	IZFR6N-E	4757	-	-
130 hp - E130DCXINA			12-	1,10	IZFR6N-E	4757	-	-
130 hp - E130DCXISC / E130DCXISF			10-	1,10	IZFR6N-E	4757	-	-
130 hp - E130DCXSES			09-	1,10	IZFR6F11	4095	-	-
130 hp - E130DPLIIR			11-	1,10	IZFR6N-E	4757	-	-
130 hp - E130DPLINA			12-	1,10	IZFR6N-E	4757	-	-
130 hp - E130DPLISC / E130DPLISF			10-	1,10	IZFR6N-E	4757	-	-
130 hp - E130DPLSES			09-	1,10	IZFR6F11	4095	-	-
130 hp - E130DPXIIR			11-	1,10	IZFR6N-E	4757	-	-
130 hp - E130DPXINA			12-	1,10	IZFR6N-E	4757	-	-
130 hp - E130DPXISC / E130DPXISF			10-	1,10	IZFR6N-E	4757	-	-
130 hp - E130DPXSES			09-	1,10	IZFR6F11	4095	-	-
130 hp - E130DSLIIIR			11-	1,10	IZFR6N-E	4757	-	-
130 hp - E130DSLINA			12-	1,10	IZFR6N-E	4757	-	-
130 hp - E130DSLISC / E130DSLISF			10-	1,10	IZFR6N-E	4757	-	-
130 hp - E130DLSLSES			09-	1,10	IZFR6F11	4095	-	-
135 hp			73-84	-	BUHXW-1	5526	-	-
140 hp - 140			73-84	-	BUHXW-1	5526	-	-
140 hp - LV4	4		85-03	0,80	BPZ8HS-10	3133	-	-
150 hp - COM L			93-98	0,80	BPZ8HS-10	3133	-	-
150 hp - CV6	6		78-87	-	BUHXW-1	5526	-	-
150 hp - CV6	6		88-91	0,80	BZ7HS-10	3579	-	-
150 hp - DE150CXINS / DE150PXINS			12-	1,10	IZFR6N-E	4757	-	-
150 hp - E-Tec 150 I V6 / E-Tec 150 HO V6	6		07-08	0,80	IZFR6N-E	4757	-	-
150 hp - E150DBXIIB			11-	1,10	IZFR6N-E	4757	-	-
150 hp - E150DBXINE			12-	1,10	IZFR6N-E	4757	-	-
150 hp - E150DBXISF / E150DBXISM			10-	1,10	IZFR6N-E	4757	-	-
150 hp - E150DBXSCF / E150DBXSCR			08-	1,10	IZFR6F11	4095	-	-
150 hp - E150DBXSEA			09-	1,10	IZFR6F11	4095	-	-
150 hp - E150DBXSUF			07-	0,80	IZFR6N-E	4757	-	-
150 hp - E150DCXIIB			11-	1,10	IZFR6N-E	4757	-	-



Modèle

Cyl.







N° STOCK



N° STOCK IX

200 hp - COM		92-	-	BUHW-1	5526	-	-
200 hp - COM		93-98	0,80	BPZ8HS-10	3133	-	-
200 hp - DCXSOC		05-	0,80	IZFR6N-E	4757	-	-
200 hp - DE200CXINS / DE200PXINS 2.6L V6	6	12-	1,10	IZFR6N-E	4757	-	-
200 hp - DHLSD / DHXSOS		06-	0,80	IZFR6N-E	4757	-	-
200 hp - DHLSOC / DHL SOG		05-	0,80	IZFR6N-E	4757	-	-
200 hp - DPLSOC / DPXSOC / DLSOC		05-	0,80	IZFR6N-E	4757	-	-
200 hp - E-Tec 200 HO V6 / E-Tec 200 I V6	6	07-08	0,80	IZFR6N-E	4757	-	-
200 hp - E200DCXIIE		11-	1,10	IZFR6N-E	4757	-	-
200 hp - E200DCXIND	6	12-	1,10	IZFR6N-E	4757	-	-
200 hp - E200DCXISB / E200DCXISF		10-	1,10	IZFR6N-E	4757	-	-
200 hp - E200DCXSACA / E200DCXSACF		08-	1,10	IZFR6F11	4095	-	-
200 hp - E200DCXSEM		09-	1,10	IZFR6F11	4095	-	-
200 hp - E200DCXSOC		05-	0,80	IZFR6N-E	4757	-	-
200 hp - E200DCXSUF / E200DCXSUR		07-	0,80	IZFR6N-E	4757	-	-
200 hp - E200DHLSCF / E200DHLSCG / E200DHLSCM		08-	1,10	IZFR6F11	4095	-	-
200 hp - E200DHLSD / E200DHLSDG		06-	0,80	IZFR6N-E	4757	-	-
200 hp - E200DHLSDG		05-	0,80	IZFR6N-E	4757	-	-
200 hp - E200DHLSDG / E200DHLSDG		07-	0,80	IZFR6N-E	4757	-	-
200 hp - E200DHXSACF / E200DHXSACG / E200DHXSACR		08-	1,10	IZFR6F11	4095	-	-
200 hp - E200DHXSOS		06-	0,80	IZFR6N-E	4757	-	-
200 hp - E200DHXSUC		07-	0,80	IZFR6N-E	4757	-	-
200 hp - E200DPLIIE		11-	1,10	IZFR6N-E	4757	-	-
200 hp - E200DPLIND	6	12-	1,10	IZFR6N-E	4757	-	-
200 hp - E200DPLISB / E200DPLISF		10-	1,10	IZFR6N-E	4757	-	-
200 hp - E200DPLSACA		08-	1,10	IZFR6F11	4095	-	-
200 hp - E200DPLSEM		09-	1,10	IZFR6F11	4095	-	-
200 hp - E200DPLSUF / E200DPLSUR		07-	0,80	IZFR6N-E	4757	-	-
200 hp - E200DPXIIE		11-	1,10	IZFR6N-E	4757	-	-
200 hp - E200DPXIND	6	12-	1,10	IZFR6N-E	4757	-	-
200 hp - E200DPXISB / E200DPXISF		10-	1,10	IZFR6N-E	4757	-	-
200 hp - E200DPXSACA		08-	1,10	IZFR6F11	4095	-	-
200 hp - E200DPXSEM		09-	1,10	IZFR6F11	4095	-	-
200 hp - E200DPXSOC		05-	0,80	IZFR6N-E	4757	-	-
200 hp - E200DPXSUF / E200DPXSUR		07-	0,80	IZFR6N-E	4757	-	-
200 hp - E200DSLIIIE		11-	1,10	IZFR6N-E	4757	-	-
200 hp - E200DSLIND	6	12-	1,10	IZFR6N-E	4757	-	-
200 hp - E200DSLISB / E200DSLISF		10-	1,10	IZFR6N-E	4757	-	-
200 hp - E200DSLSCACA		08-	1,10	IZFR6F11	4095	-	-
200 hp - E200DSLSEM		09-	1,10	IZFR6F11	4095	-	-
200 hp - E200DLSOC		05-	0,80	IZFR6N-E	4757	-	-
200 hp - E200DLSUF / E200DLSUR		07-	0,80	IZFR6N-E	4757	-	-
200 hp - E200HCXSACF / E200HCXSACG / E200HCXSACR		08-	1,10	IZFR6F11	4095	-	-
200 hp - E200HCXSOS		06-	0,80	IZFR6N-E	4757	-	-
200 hp - E200HCXSUC		07-	0,80	IZFR6N-E	4757	-	-
200 hp - E200HLSACF / E200HLSACG / E200HLSACR		08-	1,10	IZFR6F11	4095	-	-
200 hp - E200HLSOS		06-	0,80	IZFR6N-E	4757	-	-
200 hp - E200HLSUC		07-	0,80	IZFR6N-E	4757	-	-
200 hp - E200HVLSCF / E200HVLSCG / E200HVLSCM		08-	1,10	IZFR6F11	4095	-	-
200 hp - F Models		05-	0,80	PZFR6H	7696	-	-
200 hp - HCXSOS / HLSOS		06-	0,80	IZFR6N-E	4757	-	-
200 hp - LV6 F.F.I.	6	99-04	0,80	PZFR6H	7696	-	-
200 hp - V6	6	86-93	0,80	BZ7HS-10	3579	-	-
200 hp - Vindicator L		94-98	0,80	BPZ8HS-10	3133	-	-
225 hp	6	86-93	0,80	BZ7HS-10	3579	-	-
225 hp		04-	0,80	PZFR6H	7696	-	-
225 hp - DCXSDR / DCZSDR / DHLSD		06-	0,80	IZFR6N-E	4757	-	-
225 hp - DCXSOC / DCZSOC / DHLSD		05-	0,80	IZFR6N-E	4757	-	-
225 hp - DHLSD / DHLSDG / DHXSOG / DHXSOG		05-	0,80	IZFR6N-E	4757	-	-
225 hp - DHXSDF / DPLSDR / DPXSDR		06-	0,80	IZFR6N-E	4757	-	-
225 hp - DPLSD / DPXSOC / DPZSDR / DPZSOC		05-	0,80	IZFR6N-E	4757	-	-
225 hp - E-Tec 225 HO V6 / E-Tec 225 I V6	6	07-08	0,80	IZFR6N-E	4757	-	-
225 hp - E225DCXSACF / E225DCXSACG / E225DCXSACM		08-	1,10	IZFR6F11	4095	-	-
225 hp - E225DCXSACA / E225DCXSACA / E225DCXSACA		07-	1,10	IZFR6F11	4095	-	-
225 hp - E225DCZSACF / E225DCZSACG / E225DCZSACM		08-	1,10	IZFR6F11	4095	-	-
225 hp - E225DHLSCF / E225DHLSCG / E225DHLSCM		08-	1,10	IZFR6F11	4095	-	-
225 hp - E225DHLSDG / E225DHLSDG		07-	1,10	IZFR6F11	4095	-	-
225 hp - E225DHXSACA / E225DHXSACF / E225DHXSACG		08-	1,10	IZFR6F11	4095	-	-
225 hp - E225DHXSUG / E225DHXSUR		07-	1,10	IZFR6F11	4095	-	-
225 hp - E225DPLSACF / E225DPLSACG / E225DPLSACM		08-	1,10	IZFR6F11	4095	-	-
225 hp - E225DPLSACA / E225DPLSUG		07-	1,10	IZFR6F11	4095	-	-
225 hp - E225DPXSACF / E225DPXSACG / E225DPXSACM		08-	1,10	IZFR6F11	4095	-	-
225 hp - E225DPXSACA / E225DPXSUG		07-	1,10	IZFR6F11	4095	-	-
225 hp - E225DPZSACF / E225DPZSACG / E225DPZSACM		08-	1,10	IZFR6F11	4095	-	-
225 hp - E225HLSACF / E225HLSACG		08-	1,10	IZFR6F11	4095	-	-

Modèle	Cyl.				N° STOCK		N° STOCK IX
225 hp - F Models		05-	0,80	PZFR6H	7696	-	-
225 hp - LV6 F.F.I.	6	99-04	0,80	PZFR6H	7696	-	-
225 hp - Vindicator		94-98	0,80	BPZ8HS-10	3133	-	-
235 hp		78-85	-	BUHXW-1	5526	-	-
250 hp - DCXSDR / DCXSOC / DCZSOC		05-	0,80	IZFR6N-E	4757	-	-
250 hp - DCZSDR / DPLSDR / DPXSDR / DPZSDR		06-	0,80	IZFR6N-E	4757	-	-
250 hp - DPLSOC / DPXSOC / DPZSOC		05-	0,80	IZFR6N-E	4757	-	-
250 hp - E-Tec 250 I V6 (Sauf moteur 250 H.O.)	6	07-08	0,80	IZFR6N-E	4757	-	-
250 hp - E250DCXSCF / E250DCXSCG / E250DCXSOM		08-	1,10	IZFR6F11	4095	-	-
250 hp - E250DCXSUA / E250DCXSUG / E250DCZSUA		07-	1,10	IZFR6F11	4095	-	-
250 hp - E250DCZSCF / E250DCZSCG / E250DCZSCM		08-	1,10	IZFR6F11	4095	-	-
250 hp - E250DPLSCF / E250DPLSCG / E250DPLSCM		08-	1,10	IZFR6F11	4095	-	-
250 hp - E250DPLSUA / E250DPXSUA / E250DPXSUG		07-	1,10	IZFR6F11	4095	-	-
250 hp - E250DPXSCF / E250DPXSCG / E250DPXSOM		08-	1,10	IZFR6F11	4095	-	-
250 hp - E250DPZSCF / E250DPZSCG / E250DPZSCM		08-	1,10	IZFR6F11	4095	-	-
250 hp - E250DPZSUA / E250DPZSUG		07-	1,10	IZFR6F11	4095	-	-
250 hp - E250FCXSOB / E250FCZSOB / E250FPLSOM		05-	0,80	PZFR6H	7696	-	-
250 hp - E250FPXSOB / E250FPZSOB		05-	0,80	PZFR6H	7696	-	-
250 hp - F Models V8	8	05-	0,80	PZFR6H	7696	-	-
250 hp - V8	8	85-98	0,80	BPZ8HS-10	3133	-	-
250 hp - V8	8	03-04	0,80	PZFR6H	7696	-	-
275 hp		85-88	0,80	BPZ8HS-10	3133	-	-
300 hp - V8	8	85-97	0,80	BPZ8HS-10	3133	-	-

EXPLORER

3.5 / 5.0 / 7.5 / 9.9 / 15 hp	81-84	0,80	XR5	3332	XR5IX	7355
-------------------------------	-------	------	-----	------	-------	------

FEDERAL

3.5 / 5.0 / 7.0 hp	71-74	0,70	XR4	5858	XR4IX	7189
--------------------	-------	------	-----	------	-------	------

FIAT NAUTICA

3.5 / 6.0 / 8.0 / 12.0 / 14.0 / 24.0 hp	-	0,90	BR6HS	3922	BR6HIX	3419
---	---	------	-------	------	--------	------

FIRESTONE

Featherweight 5	66-	0,80	BR6S	3522	-	-
-----------------	-----	------	------	------	---	---

FISHER PIERCE

Bearcat 55	-	0,80	BR6S	3522	-	-
Bearcat 85	-	0,80	BR8ES	5422	BR8EIX	5044

FLAMBEAU

Single (2.5PS), Double (5 PS)	-	0,60	B6S	3510	-	-
-------------------------------	---	------	-----	------	---	---

FLYING-O

3.5 / 5.0 / 7.0 hp	68-69	0,80	BR6S	3522	-	-
5.0 hp	70-74	0,70	XR4	5858	XR4IX	7189
5.5 hp	75-	0,70	XR4	5858	XR4IX	7189
7.0 hp	70-72	0,70	XR4	5858	XR4IX	7189
7.5 hp	73-	0,70	XR4	5858	XR4IX	7189
9.9 / 15.0 hp	73-74	0,70	XR4	5858	XR4IX	7189

FORCE (U.S. MARINE)

2.0 hp	96-98	0,70	B7HS	5110	BR7HIX	7067
3.0 hp	90-94	1,00	BP6HS-10	6326	-	-
4.0 hp	84-87	0,80	B6HS	4510	BR6HIX	3419
5.0 hp	88-93	0,80	BP6HS	4511	BPR6HIX	4085
5.0 / 9.9 hp	94-99	0,90	BP6HS	4511	BPR6HIX	4085
7.5 hp	85-	0,80	B6HS	4510	BR6HIX	3419
9.9 hp	84-93	0,80	BP6HS	4511	BPR6HIX	4085
15 hp	84-93	0,80	BP7HS	5111	BPR7HIX	5944
15 hp	94-99	0,90	BP7HS	5111	BPR7HIX	5944
25 hp	96-99	0,90	BP7HS	5111	BPR7HIX	5944
35 hp	86-91	1,00	B6HS-10	1052	-	-
40 hp	92-93	-	BUHW	2622	-	-
40 hp	94-99	-	BUZHW	2147	-	-
50 hp	84-87	0,80	B7HS	5110	BR7HIX	7067
50 hp	88-91	-	BUHX	2522	-	-
50 hp - w/Thunderbolt Ign.	91-93	-	BUHW	2622	-	-
50 / 90 / 120 hp - w/Thunderbolt Ign.	94-99	-	BUZHW	2147	-	-
60 hp	85-	-	BUHW	2622	-	-

FORCE (U.S. MARINE)

Modèle

Cyl.

 N°
STOCK

 N°
STOCK IX

70 hp - w/Thunderbolt Ign.		91-95	-	BUHW	2622	-	-
75 hp		96-99	-	BUZHW	2147	-	-
85 / 125 hp		83-89	-	BUHX	2522	-	-
90 / 120 hp - w/Presolite Ign.		90-91	-	BUHX	2522	-	-
90 / 120 hp - w/Thunderbolt Ign.		91-93	-	BUHW	2622	-	-
150 hp - w/Presolite Ign.		89-91	-	BUHX	2522	-	-
150 hp - w/Thunderbolt Ign.		91-94	-	BUHW	2622	-	-

FOREMOST

9.2 hp		-	0,80	BR6S	3522	-	-
--------	--	---	------	------	------	---	---

FRANCHI

6 hp		-	0,70	B6S	3510	-	-
18 / 40 hp		-	0,70	B-6L	3212	-	-

FURY

3.5 hp		61-	0,80	BR6S	3522	-	-
--------	--	-----	------	------	------	---	---

GALE

Buccaneer 3 / 5 / 5.5 / 12 / 15 / 25 / 35 / 40 / 60 PS		-	0,80	B6S	3510	-	-
Sovereign 35 / 40 / 60 PS		-	0,80	B6S	3510	-	-

GAMBLES

3.5 / 5.0 hp		-69	0,80	BR6S	3522	-	-
3.5 / 5.0 hp		70-	0,70	XR4	5858	XR4IX	7189
7.0 hp		69-	0,70	XR4	5858	XR4IX	7189

GARELLI

Gari Jet		-	0,50	B6HS	4510	BR6HIX	3419
----------	--	---	------	------	------	--------	------

GUAZZONI





Gamberino 4.5 PS		-	0,50	B6S	3510	-	-
------------------	--	---	------	-----	------	---	---

HANIMEX

4.5 / 5.5 / 7.5 hp		-	0,80	BP5S	3011	-	-
9.9 / 15 hp		-	0,80	B6S	3510	-	-

HONDA

2.0 hp - BF2A - 1 cyl. 4 temps SOHV	1	-00	0,60	BMR4A	5728	-	-
2.0 hp - BF2D (->1026043) 4 temps Soupap. latérales	1	01-	0,60	CR5HSB	6535	-	-
2.0 hp - BF2D (1026044->) 4 temps Soupap. latérales	1	99-	0,60	CR4HSB	4695	-	-
2.0 hp - BF20 - 1 cyl. 4 temps Soupap. latérales	1	84-98	0,60	BMR4A	5728	-	-
2.0 hp - BF2D2 / BF2D4 - 1 cyl. 4 temps 57cc	1	-	0,70	CR4HSB	4695	-	-
2.3 hp - BF2.3		-	0,60	CR5HSB	6535	-	-
2.3 hp - BF2.3D		05-	0,60	CR4HSB	4695	-	-
2.3 hp - BF2.3D4 / BF2.3DK2 - 1 cyl. 4 temps 57cc	1	-	0,70	CR4HSB	4695	-	-
4.5 hp - BF4.5 / BF4.5D		-	0,70	BPR5ES	7422	BPR5EIX	6597
5.0 hp - BF5		-	0,70	BPR5ES	7422	BPR5EIX	6597
5.0 hp - BF5A / BF50 - 1 cyl. 4 temps SOHV	1	-	0,70	BPR5ES	7422	BPR5EIX	6597
5.0 hp - BF5 A2 / A4 / AK2 / DK2SB - 4 temps 127cc	1	-	0,90	BPR5ES	7422	BPR5EIX	6597
6.0 hp - BF6		-	0,60	DR4HS	3326	-	-
6.0 hp - BF6CH		04-	0,90	CR5EH-9	6689	-	-
7.5 hp - BF75 / BF75 - 2 cyl. 4 temps SOHC	2	77-	0,60	DR5HS	4623	-	-
8.0 hp - BF8 / BF8A - 2 cyl. 4 temps SOHC	2	-00	0,60	DR5HS	4623	-	-
8.0 hp - BF8 - 2 cyl. 4 temps SOHC	2	01-	0,90	CR5EH-9	6689	-	-
8.0 hp - BF8B1		-	0,90	CR5EH-9	6689	-	-
8.0 hp - BF8C - 2 cyl. 4 temps SOHC	2	-	0,60	DR5HS	4623	-	-
8.0 hp - BF8D - 2 cyl. 4 temps SOHC	2	01-	0,90	CR5EH-9	6689	-	-
8.0 hp - BF8D1 - 2 cyl. 4 temps SOHC	2	-	0,90	CR5EH-9	6689	-	-
8.0 hp - BF8D2 / BF8DK2 - 2 cyl. 4 temps 222cc	2	-	0,90	CR5EH-9	6689	-	-
8.0 hp - BFP8D / BFP8D1 - 2 cyl. 4 temps SOHC	2	01-	0,90	CR5EH-9	6689	-	-
9.8 hp - BF100 - 2 cyl. 4 temps SOHC	2	-	0,60	DR5HS	4623	-	-
9.9 hp - BF9.9A - 2 cyl. 4 temps SOHC	2	-00	0,60	DR5HS	4623	-	-
9.9 hp - BF9.9D / BFP9.9D - 2 cyl. 4 temps SOHC	2	01-	0,90	CR5EH-9	6689	-	-
10 hp - BF10 / BF10B1 / BF10D		01-	0,90	CR5EH-9	6689	-	-
10 hp - BF10D2 / BF10S1 - 2 cyl. 4 temps 222cc	2	-	0,90	CR5EH-9	6689	-	-
10 hp - BF100 - 2 cyl. 4 temps SOHC	2	-	0,60	DR5HS	4623	-	-
15 hp - BF15A - 2 cyl. 4 temps SOHC	2	-00	0,60	DR6HS	4823	-	-
15 hp - BF15AX - 2 cyl. 4 temps 350cc	2	-	0,70	DR6HS	4823	-	-
15 hp - BF15D - 2 cyl. 4 temps SOHC	2	01-	0,90	CR5EH-9	6689	-	-

	Modèle	Cyl.				N° STOCK		N° STOCK IX
15 hp - BF15D3 / BF15DK2 - 2 cyl. 4 temps 350cc		2	-	0,90	CR5EH-9	6689	-	-
15 hp - BFP15D - 2 cyl. 4 temps SOHC		2	01-	0,90	CR5EH-9	6689	-	-
20 hp - BF20A			-	0,70	DR7EA	7839	-	-
20 hp - BF20A2 - 2 cyl. 4 temps 350cc		2	-	0,70	DR7EB	5469	-	-
20 hp - BF20D - 2 cyl. 4 temps SOHC		2	01-	0,90	CR5EH-9	6689	-	-
20 hp - BF20D3 / BF20DK2 - 2 cyl. 4 temps 350cc		2	-	0,90	CR5EH-9	6689	-	-
20 hp - BFP20D - 2 cyl. 4 temps SOHC		2	01-	0,90	CR5EH-9	6689	-	-
25 hp - BF25 / BF25A / BF25B - 3 cyl. 4 temps SOHC		3	-	0,70	DR7EA	7839	-	-
25 hp - BF25A2 - 3 cyl. 4 temps 499cc		3	-	0,70	DR7EA	7839	-	-
25 hp - BF25D - 3 cyl. 4 temps SOHC		3	04-	0,70	DR7EA	7839	-	-
25 hp - BF25D4 / BF25DK2 - 3 cyl. 4 temps 552cc		3	-	0,70	DR7EA	7839	-	-
30 hp - BF30 / BF30A - 3 cyl. 4 temps SOHC		3	-	0,70	DR7EA	7839	-	-
30 hp - BF30A2 - 3 cyl. 4 temps 499cc		3	-	0,70	DR7EA	7839	-	-
30 hp - BF30D - 3 cyl. 4 temps SOHC		3	04-	0,70	DR7EA	7839	-	-
30 hp - BF30D4 / BF30DK2 - 3 cyl. 4 temps 552cc		3	-	0,70	DR7EA	7839	-	-
35 hp - BF35 - 3 cyl. 4 temps SOHC		3	-	0,70	DR7EA	7839	-	-
35 hp - BF35A - 3 cyl. 4 temps SOHC		3	90-	0,70	DR7EA	7839	-	-
40 hp - BF40 - 3 cyl. 4 temps SOHC		3	-	0,70	DR7EA	7839	-	-
40 hp - BF40A - 3 cyl. 4 temps SOHC		3	94-	0,70	DR7EA	7839	-	-
40 hp - BF40A2 / BF40A4 - 3 cyl. 4 temps 808cc		3	-	0,70	DR7EA	7839	-	-
40 hp - BF40B - 3 cyl. 4 temps SOHC		3	-	0,70	DR7EA	7839	-	-
40 hp - BF40D - 3 cyl. 4 temps SOHC		3	-	0,70	DR7EB	5469	-	-
40 hp - B40DK2 - 3 cyl. PGMFI 4 temps 808 cc		3	-	0,70	DR7EB	5469	-	-
45 hp - B45 - 3 cyl. 4 temps SOHC		3	90-	0,60	DR5HS	4623	-	-
45 hp - BF45 / BF45A - 3 cyl. 4 temps SOHC		3	-	0,70	DR7EA	7839	-	-
50 hp - BF50 / BF50A - 3 cyl. 4 temps SOHC		3	-	0,70	DR7EA	7839	-	-
50 hp - BF50A2 / BF50A4 - 3 cyl. 4 temps 808cc		3	-	0,70	DR7EA	7839	-	-
50 hp - BF50D - 3 cyl. 4 temps SOHC		3	-	0,70	DR7EB	5469	-	-
50 hp - BF50DK2 - 3 cyl. PGMFI 4 temps 808cc		3	-	0,70	DR7EB	5469	-	-
50 hp - BF50F - 3 cyl. 4 temps SOHC		3	-	0,70	BPR5ES	7422	BPR5EIX	6597
50 hp - F50			-	0,70	DR7EB	5469	-	-
60 hp - BF60A / BFP60A - 3 cyl. 4 temps SOHC		3	-	0,90	LMAR6A-9	5946	-	-
75 hp - BF75A - 4 cyl. 4 temps SOHC 1590cc		4	03-	0,70	DR7EA	7839	-	-
75 hp - BF75A2 - 4 cyl. 4 temps 1590cc		4	-	0,70	DR7EA	7839	-	-
75 hp - BF75B - 4 cyl. 4 temps SOHC		4	-	0,70	DR7EA	7839	-	-
75 hp - BF75D V-TEC 4 cyl. 4 Temps 1496cc		4	06-	1,10	IZFR6K-11E	6748	-	-
75 hp - BF75DK 4 cyl. 4 Temps 1496cc		4	-	1,10	IZFR6K-11E	6748	-	-
90 hp - BF90A - 4 cyl. 4 temps SOHC 1590cc		4	95-	0,70	DR7EA	7839	-	-
90 hp - BF90A2 - PGMFI 4 cyl. 4 temps SOHC 1590cc		4	-	0,70	DR7EA	7839	-	-
90 hp - BF90D V-TEC 4 cyl. 4 Temps 1496cc		4	06-	1,10	IZFR6K-11E	6748	-	-
90 hp - BF90DK2 4 cyl. PGMFI 4 Temps 1496cc		4	-	1,10	IZFR6K-11E	6748	-	-
100 hp - BF100 / BF100E			-	0,60	DR5HS	4623	-	-
115 hp - BF115 - 4 cyl. 4 temps SOHC		4	-	0,80	ZFR7F	5913	-	-
115 hp - BF115A - 4 cyl. 4 temps SOHC		4	98-	0,80	ZFR7F	5913	-	-
115 hp - BF115A2 - EFI 4 cyl. 4 temps 2254cc		4	-	0,80	ZFR7F-11	2975	-	-
115 hp - BF115AX - EFI 4 cyl. 4 temps 2254cc		4	-	0,80	ZFR7F	5913	-	-
115 hp - BF115D - 4 cyl. 4 temps SOHC 2254cc		4	-	1,10	IZFR6K11	6994	-	-
115 hp - BF115DK1 - 4 cyl. PGMFI 4 temps 2254cc		4	-	1,10	IZFR6K11	6994	-	-
130 hp - BF130 / BF130A - 4 cyl. 4 temps SOHC		4	-	0,80	ZFR7F	5913	-	-
130 hp - BF130A2 - 4 cyl. EFI 4 temps 2254cc		4	-	0,80	ZFR7F-11	2975	-	-
130 hp - BF130AX - 4 cyl. EFI 4 temps 2254cc		4	-	0,80	ZFR7F	5913	-	-
135 hp - BF135 - 4 cyl. 4 temps DOHC		4	-	1,10	IZFR6K11	6994	-	-
135 hp - BF135A4 - 4 cyl. EFI 4 temps 2354cc		4	-	1,10	IZFR6K11	6994	-	-
135 hp - BF135AK2 - 4 cyl. PGMFI 4 temps 2354cc		4	-	1,10	IZFR6K11	6994	-	-
150 hp - BF150 - 4 cyl. 4 temps DOHC		4	-	1,10	ZFR6K-11	6711	-	-
150 hp - BF150A4 - 4 cyl. EFI 4 temps		4	-	1,10	IZFR6K11	6994	-	-
150 hp - BF150AK2 - 4 cyl. PGMFI 4 temps 2354cc		4	-	1,10	IZFR6K11	6994	-	-
175 hp - BF175 A3 / A6 - V6 EFI 4 temps 3471cc		6	-	1,10	IZFR6K11	6994	-	-
175 hp - BF175AK1 - V6 EFI 4 temps 3471cc		6	-	1,10	IZFR6K11	6994	-	-
175 hp - BF175AK2 - V6 PGMFI 4 temps 3471cc		6	-	1,10	IZFR6K11	6994	-	-
200 hp - BF200 - 4 cyl. 4 temps DOHC		4	-	1,10	IZFR6F11	4095	-	-
200 hp - BF200A			02-	1,10	IZFR6F11	4095	-	-
200 hp - BF200 A2 / A6 V6 EFI 4 temps 3471cc		6	-	1,10	IZFR6F11	4095	-	-
200 hp - BF200AK1 V6 EFI 4 temps 3471cc		6	-	1,10	IZFR6F11	4095	-	-
200 hp - BF200AK2 V6 PGMFI 4 temps 3471cc		6	-	1,10	IZFR6F11	4095	-	-
220 hp - BF220 - 4 cyl. 4 temps SOHC		4	-	1,10	IZFR6F11	4095	-	-
225 hp - BF225 - 4 cyl. 4 temps SOHC		4	-	1,10	IZFR6F11	4095	-	-
225 hp - BF225A		6	02-	1,10	IZFR6F11	4095	-	-
225 hp - BF225 A2 / A6 - V6 EFI 4 temps 3471cc		6	-	1,10	IZFR6F11	4095	-	-
225 hp - BF225AK1 - V6 EFI 4 temps 3471cc		6	-	1,10	IZFR6F11	4095	-	-
225 hp - BF225AK2 - V6 PGMFI 4 temps 3471cc		6	-	1,10	IZFR6F11	4095	-	-
250 hp - BF250A - V6 4 temps PGMFI 3583cc		6	-	1,10	IZFR6F11	4095	-	-



Modèle

Cyl.



N° STOCK



N° STOCK IX

HUSQVARNA

Tous modèles	-	0,50	B6HS	4510	BR6HIX	3419
--------------	---	------	------	------	--------	------

ITALMARINE

70 hp 920 25 SIL / SITL	-	1,00	BZ7HS-10	3579	-	-
150 / 175 hp Ocean Runner V6	6	-	BUZHW	2147	-	-
200 / 225 / 250 hp Ocean Runner V6	6	1,00	BZ7HS-10	3579	-	-

J.C.PENNY





3.0 hp	74-80	0,70	XR4	5858	XR4IX	7189
3.5 hp	78-80	0,70	XR4	5858	XR4IX	7189
5.0 hp	79-	0,70	XR4	5858	XR4IX	7189
5.5 hp	74-78	0,70	XR4	5858	XR4IX	7189
7.5 hp	74-79	0,70	XR4	5858	XR4IX	7189
9.9 hp	75-79	0,70	XR4	5858	XR4IX	7189
15.0 hp	75-78	0,70	XR4	5858	XR4IX	7189





J.L.O.





Aquascooter, L35	-	0,50	B6HS	4510	BR6HIX	3419
------------------	---	------	------	------	--------	------

JOHNSON

Ø18mm	39-50	0,80	AB-6	2910	-	-
3.6 L	85-86	0,80	BZ7HS-10	3579	-	-
Air Bouy Diving Unit	-	0,60	BM4A	5628	-	-
CD, JH	54-68	0,80	B6S	3510	-	-
FD, FDE	56-68	0,80	B6S	3510	-	-
JHF, JWF	67-68	0,80	B6S	3510	-	-
JW	52-68	0,80	B6S	3510	-	-
LD	65-68	0,80	B6S	3510	-	-
MQ	64-68	0,80	B6S	3510	-	-
RD, RDE, RDDS, RJE, RK	51-68	0,80	B6S	3510	-	-
RX	62-68	0,80	B6S	3510	-	-
RXE	65-68	0,80	B6S	3510	-	-
SC	68-	0,80	B6S	3510	-	-
TN, AD, QD, V4H, V4ML	52-66	0,80	B6S	3510	-	-
1.0 hp - 1R	68-70	0,80	B6S	3510	-	-
1.1 hp	46-47	0,80	B-4L	3112	-	-
1.2 hp - Magneto	86-90	0,80	B6S	3510	-	-
1.5 / 2.0 hp	68-70	0,80	B6S	3510	-	-
2.0 hp - 1 cyl.	1 91-01	0,80	BPR6HS	7022	BPR6HIX	4085
2.0 hp - 2R	71-84	0,80	B6S	3510	-	-
2.0 hp - Aquanaut Diving Unit	66-70	0,80	BM4A	5628	-	-
2.0 hp - Colt, Jr	71-90	0,80	B6S	3510	-	-
2.0 hp - Excel 4, Ultra	87-88	0,80	B7HS	5110	BR7HIX	7067
2.3 hp - 1 cyl.	1 91-98	0,80	BPR6HS	7022	BPR6HIX	4085
2.5 hp	87-88	0,80	BR6HS	3922	BR6HIX	3419
3.0 hp	52-68	0,80	B6S	3510	-	-
3.0 hp - 2 cyl.	2 89-97	0,80	BR6HS	3922	BR6HIX	3419
3.0 hp - Lightwin	52-74	0,80	B6S	3510	-	-
3.3 hp	48-51	0,80	B6S	3510	-	-
3.3 hp - 1 cyl.	1 91-03	0,80	BPR6HS	7022	BPR6HIX	4085
3.5 hp	04-05	0,50	BP7HS	5111	BPR7HIX	5944
4.0 hp	69-76	0,80	B6S	3510	-	-
4.0 hp	77-87	0,80	BR6HS	3922	BR6HIX	3419
4.0 hp	81-84	0,80	BZ7HS-10	3579	-	-
4.0 hp	88-	0,80	BZ7HS-10	3579	-	-
4.0 hp	04-05	0,90	BPR6ES	7822	BPR6EIX	6637
4.0 hp - 2 cyl.	2 89-03	0,80	BR6HS	3922	BR6HIX	3419
4.0 hp - 4R, 4W	69-76	0,80	B6S	3510	-	-
4.0 hp - Excel, Ultra	87-88	0,80	BZ7HS-10	3579	-	-
4.0 hp - V4, V4A, V4M, V4S, VX, VXH	58-67	0,80	B6S	3510	-	-
4.5 hp	80-85	0,80	BR6HS	3922	BR6HIX	3419
5.0 hp	90-02	0,80	BR6HS	3922	BR6HIX	3419
5.0 hp	04-05	0,90	BPR6ES	7822	BPR6EIX	6637
5.0 hp - 1 cyl.	1 98-01	0,80	BZ7HS-10	3579	-	-
5.0 hp - 4 temps	97-03	0,70	D6HA	6512	-	-
5.0 hp - Angler	65-68	0,80	B6S	3510	-	-
5.2 hp - Lightwin	52-74	0,80	B6S	3510	-	-
5.5 hp	56-64	0,80	B6S	3510	-	-
6.0 hp	65-76	0,80	B6S	3510	-	-
6.0 hp	05-	0,90	BPR6ES	7822	BPR6EIX	6637
6.0 hp - 2 temps	77-01	0,80	BR6HS	3922	BR6HIX	3419

Modèle	Cyl.				N° STOCK	IX	
							N° STOCK IX
6.0 hp - 4 temps		97-03	0,70	D6HA	6512	-	-
6.0 hp - 6R, 6RL		71-76	0,80	B6S	3510	-	-
6.0 hp - RLSRS, RSRS		04-	0,80	BR6HS	3922	BR6HIX	3419
6.5 hp - COM		81-93	0,80	BR6HS	3922	BR6HIX	3419
7.5 hp		52-58	0,80	B6S	3510	-	-
7.5 hp		77-97	0,80	BR6HS	3922	BR6HIX	3419
8.0 hp		05-	0,80	BR6HS	3922	BR6HIX	3419
8.0 hp - 2 temps		77-01	0,80	BR6HS	3922	BR6HIX	3419
8.0 hp - 4 temps		96-98	0,70	D6HA	6512	-	-
8.0 hp - 4 temps 211cc		96-03	0,70	D6HA	6512	-	-
8.0 hp - COM		77-01	0,80	BR6HS	3922	BR6HIX	3419
8.0 hp - RLSRC, RSRC		04-	0,80	BR6HS	3922	BR6HIX	3419
9.0 hp - 9R, 9RL, 9EL		74-	0,80	BZ7HS-10	3579	-	-
9.5 hp		52-73	0,80	B6S	3510	-	-
9.7 hp		42-49	0,80	AB-6	2910	-	-
9.9 hp		74-76	0,80	B7HS	5110	BR7HIX	7067
9.9 hp - 2 temps OHC		77-01	0,80	BR7HS	4122	BR7HIX	7067
9.9 hp - 2 temps SOHC		02-04	0,80	DCPR7E	3932	DCPR7EIX	6046
9.9 hp - 4 temps OHC 302cc		02-04	0,80	DCPR7E	3932	DCPR7EIX	6046
9.9 hp - 4 temps OHC 305cc		95-04	0,80	DCPR7E	3932	DCPR7EIX	6046
10 hp		52-63	0,80	B6S	3510	-	-
10 hp		06-	0,80	BR7HS	4122	BR7HIX	7067
10 hp - 10E, 10EL		75-76	0,80	BZ7HS-10	3579	-	-
10 hp - 10E, 10R, 10SEL		77-79	-	BUHW-2	5626	-	-
10 hp - 10R, 10RL		75-76	0,80	BZ7HS-10	3579	-	-
10 hp - COM		81-82	-	BUHW-2	5626	-	-
10 hp - COM		92-93	0,80	BZ7HS-10	3579	-	-
10 hp - COM		94-02	0,80	BR7HS	4122	BR7HIX	7067
10 hp - EL4SOR, R4SOA, L4SOA		05-	0,80	BKR6ES	3783	BKR6EIX	6418
10 hp - TBL4SOB, TE4SOA, TEL4SOA		05-	0,80	BKR6ES	3783	BKR6EIX	6418
10 hp - EL4SRC, R4SR, RL4SR, RBL4SR, RE4SR, TEL4SR		04-	0,90	DCPR6E	3481	DCPR6EIX	8196
10 hp - R4STC, BL4STS, LE4STS, L4STC		03-	0,90	DCPR6E	3481	DCPR6EIX	8196
10 hp - BL4STC, RE4STC, TEL4STC		03-	0,90	DCPR6E	3481	DCPR6EIX	8196
10 hp - RHLSOR, RHSOR, RLSOS, RSOS		05-	0,80	BR7HS	4122	BR7HIX	7067
10 hp - RHLSRC, RHSRC, RLSRD, RSRD		04-	0,80	BR7HS	4122	BR7HIX	7067
10 hp - RHLSTS, RHSTS, RLSTE, RSTE		03-	0,80	BR7HS	4122	BR7HIX	7067
14 hp		88-89	0,80	BZ7HS-10	3579	-	-
14 hp - COM		81-91	0,80	BZ7HS-10	3579	-	-
14 hp - Fastwin		50-72	0,80	B6S	3510	-	-
15 hp		56-71	0,80	B6S	3510	-	-
15 hp		74-76	0,80	B7HS	5110	BR7HIX	7067
15 hp		77-92	0,80	BZ7HS-10	3579	-	-
15 hp		78-80	-	BUHW-2	5626	-	-
15 hp		05-	0,80	BKR6ES	3783	BKR6EIX	6418
15 hp		06-	0,80	BR7HS	4122	BR7HIX	7067
15 hp - 2 temps		94-01	0,80	BR7HS	4122	BR7HIX	7067
15 hp - 4 temps OHC		95-03	0,80	DCPR7E	3932	DCPR7EIX	6046
15 hp - 15E, 15EL, 15R, 15RL		74-76	0,80	BZ7HS-10	3579	-	-
15 hp - COM		92-93	0,80	BZ7HS-10	3579	-	-
15 hp - COM		94-01	0,80	BR7HS	4122	BR7HIX	7067
15 hp - Kero		95-98	-	BUHXW-1	5526	-	-
15 hp - L4SR, R4SR, TE4SR, TEL4SR		04-	0,90	DCPR6E	3481	DCPR6EIX	8196
15 hp - LRSR, RSRS, WRLSRM, WRSRM		04-	0,80	BR7HS	4122	BR7HIX	7067
18 hp		57-73	0,80	B6S	3510	-	-
18 hp - Fastwin		50-72	0,80	B6S	3510	-	-
18 hp - Fastwin		57-73	0,80	B8S	3810	-	-
18 hp - Jet 2		74-94	0,80	BR6HS	3922	BR6HIX	3419
18 hp - Jet 2 cyl.	2	95-98	0,80	BR7HS	4122	BR7HIX	7067
20 hp		66-73	0,80	B6S	3510	-	-
20 hp		78-93	0,80	BR7HS	4122	BR7HIX	7067
20 hp - 2 cyl.	2	78-98	0,80	BR7HS	4122	BR7HIX	7067
20 hp - 20R, 20RL		73-	0,80	B6S	3510	-	-
20 hp - 20R, 25R		69-72	0,80	B6S	3510	-	-
20 hp - 20RL, 25RL		71-72	0,80	B6S	3510	-	-
20 hp - Jet 2 cyl.	2	99-01	0,80	BR7HS	4122	BR7HIX	7067
25 hp		52-55	0,80	B6S	3510	-	-
25 hp		69-76	0,80	B6S	3510	-	-
25 hp		03-05	0,80	BZ7HS-10	3579	-	-
25 hp - 2 cyl.	2	77-02	0,80	BR7HS	4122	BR7HIX	7067
25 hp - 3 cyl.	3	95-01	0,80	BR6HS	3922	BR6HIX	3419
25 hp - 20R, 25R		69-72	0,80	B6S	3510	-	-
25 hp - 25E, 25EL, 25R, 25RL		73-76	0,80	B6S	3510	-	-
25 hp - 25E, 25EL, 25R		77-78	-	BUHW-2	5626	-	-
25 hp - COM		81-02	-	BUHXW-1	5526	-	-
28 hp		62-64	0,80	B6S	3510	-	-

 Modèle	Cyl.				N° STOCK		N° STOCK IX
28 hp - 28 Jet		92-03	0,80	BPZ8HS-10	3133	-	-
28 hp - SPL2 cyl.	2	78-97	0,80	BR7HS	4122	BR7HIX	7067
30 hp		04-05	0,80	BZ7HS-10	3579	-	-
30 hp - 2 cyl.	2	78-02	0,80	BR7HS	4122	BR7HIX	7067
30 hp - 2 cyl. Jet	2	99-01	0,80	BPR7HS	6422	BPR7HIX	5944
30 hp - 4 temps OHC		95-03	0,80	DCPR7E	3932	DCPR7EIX	6046
33 / 35 hp		69-70	0,80	B6S	3510	-	-
35 hp		57-59	0,80	B6S	3510	-	-
35 hp		76-	0,80	B7HS	5110	BR7HIX	7067
35 hp		77-79	-	BUHW-2	5626	-	-
35 hp - 2 cyl.	2	77-97	0,80	BZ7HS-10	3579	-	-
35 hp - 2 cyl. Jet	2	93-03	0,80	BPZ8HS-10	3133	-	-
35 hp - 3 cyl.	3	95-01	0,80	BR7HS	4122	BR7HIX	7067
40 hp		60-73	0,80	B6S	3510	-	-
40 hp		74-76	0,80	B7HS	5110	BR7HIX	7067
40 hp		05-	0,90	DCPR6E	3481	DCPR6EIX	8196
40 hp - 2 cyl.	2	80-88	0,80	BZ7HS-10	3579	-	-
40 hp - 2 cyl.	2	89-02	0,80	BPZ8HS-10	3133	-	-
40 hp - 3 cyl. Jet	3	99-01	0,80	BPR7HS	6422	BPR7HIX	5944
40 hp - 4 temps DOHC		02-03	0,80	DCPR7E	3932	DCPR7EIX	6046
40 hp - 40E, 40EL, 40R, 40RL		69-73	0,80	B6S	3510	-	-
40 hp - 40E, 40EL, 40R, 40RL		74-76	0,80	BZ7HS-10	3579	-	-
40 hp - COM		84-90	-	BUHW-2	5626	-	-
40 hp - COM 43 cid		81-90	0,80	B7HS	5110	BR7HIX	7067
40 hp - COM 45 cid		84-03	-	BUHXW-1	5526	-	-
40 hp - PL4SRM, PL4SRS		04-	0,90	DCPR6E	3481	DCPR6EIX	8196
40 hp - PLSRS, RLSRS, RSRS		04-	0,80	BZ7HS-10	3579	-	-
45 hp - COM		84-02	-	BUHXW-1	5526	-	-
48 hp - 2 cyl.	2	80-88	0,80	BZ7HS-10	3579	-	-
48 hp - 2 cyl.	2	89-97	0,80	BPZ8HS-10	3133	-	-
48 hp - 2 cyl. SPL	2	94-97	0,80	BPZ8HS-10	3133	-	-
50 hp		58-59	0,80	B6S	3510	-	-
50 hp		71-79	-	BUHW-2	5626	-	-
50 hp		05-	0,90	DCPR6E	3481	DCPR6EIX	8196
50 hp - 2 cyl.	2	80-88	0,80	BZ7HS-10	3579	-	-
50 hp - 2 cyl.	2	89-02	0,80	BPZ8HS-10	3133	-	-
50 hp - 3 cyl.	3	95-98	0,80	BPZ8HS-10	3133	-	-
50 hp - PL4STC		03-	0,90	DCPR6E	3481	DCPR6EIX	8196
50 hp - PL4SRS, PL4SRM		04-	0,90	DCPR6E	3481	DCPR6EIX	8196
50 hp - PLSRS		04-	0,80	BZ7HS-10	3579	-	-
50 hp - PLSTD		03-	0,80	BZ7HS-10	3579	-	-
50 hp - Sizzler		71-75	0,80	B7HS	5110	BR7HIX	7067
55 hp		87-88	-	BUHW-2	5626	-	-
55 hp - 2 cyl.	2	76-89	0,80	B7HS	5110	BR7HIX	7067
55 hp - 3 cyl.	3	68-69	0,80	BZ7HS-10	3579	-	-
55 hp - COM		86-05	-	BUHXW-1	5526	-	-
55 hp - COM 2 cyl.	2	94-95	0,80	BPZ8HS-10	3133	-	-
60 hp		99-01	0,80	BZ7HS-10	3579	-	-
60 hp - 2 cyl.	2	80-85	0,80	BZ7HS-10	3579	-	-
60 hp - 3 cyl. 49 cid	3	75-89	0,80	BZ7HS-10	3579	-	-
60 hp - 3 cyl. 56 cid	3	89-93	0,80	BZ7HS-10	3579	-	-
60 hp - 3 cyl. 56 cid	3	94-98	0,80	BPZ8HS-10	3133	-	-
60 hp - 4 temps OHC		02-05	0,90	BPR6ES	7822	BPR6EIX	6637
60 hp - Triumph		70-71	-	BUHW	2622	-	-
60 hp - V4		64-67	0,80	B6S	3510	-	-
65 hp - 3 cyl.	3	72-73	0,80	BZ7HS-10	3579	-	-
65 hp - 65 Jet CV4		92-97	0,80	BR7HS	4122	BR7HIX	7067
65 hp - COM 3cyl.	3	94-95	0,80	BPZ8HS-10	3133	-	-
65 hp - COM HC LC		84-87	0,80	BZ7HS-10	3579	-	-
65 hp - COM HC LC		88-03	-	BUHXW-1	5526	-	-
65 hp - V4 Sportfour		68-	0,80	BZ7HS-10	3579	-	-
70 hp		02-05	0,90	BPR6ES	7822	BPR6EIX	6637
70 hp - 3 cyl. 49 cid	3	75-89	0,80	BZ7HS-10	3579	-	-
70 hp - 3 cyl. 56 cid	3	89-93	0,80	BZ7HS-10	3579	-	-
70 hp - 3 cyl. 56 cid	3	94-01	0,80	BPZ8HS-10	3133	-	-
75 hp - V4		60-65	0,80	B6S	3510	-	-
80 hp		66-67	0,80	B6S	3510	-	-
80 hp - 80 Jet CV4		79-01	0,80	BR7HS	4122	BR7HIX	7067
80 hp - Starfire		66-67	0,80	B8S	3810	-	-
85 hp		68-80	0,80	B7HS	5110	BR7HIX	7067
85 hp		86-93	0,80	BZ7HS-10	3579	-	-
85 hp - V4 Backtroller	4	94-95	0,80	BR7HS	4122	BR7HIX	7067
88 hp - CV4 SPL		79-97	0,80	BR7HS	4122	BR7HIX	7067
90 hp		64-65	0,80	B6S	3510	-	-
90 hp		06-	0,80	BZ7HS-10	3579	-	-

Modèle	Cyl.				N° STOCK		N° STOCK IX
90 hp - Carburateur		01-02	0,80	BZ7HS-10	3579	-	-
90 hp - CV4		79-98	0,80	BR7HS	4122	BR7HIX	7067
90 hp - LV4		95-00	0,80	BPZ8HS-10	3133	-	-
90 hp - LV4 F.F.I.		98-	0,80	PZFR6H	7696	-	-
90 hp - Turbojet CV4		94-98	0,80	BR7HS	4122	BR7HIX	7067
90 hp - GLSOB, PX4SOR		05-	0,80	BKR6ES	3783	BKR6EIX	6418
90 hp - GLSRM, PLSRR, PXSRS		04-	0,80	BZ7HS-10	3579	-	-
90 hp - GLSTA, PLSTC		03-	0,80	BZ7HS-10	3579	-	-
90 hp - PL4SOR, PLSOA, PXSOC		05-	0,80	BZ7HS-10	3579	-	-
90 hp - PL4SRC, PX4SRC, PL4SRC, PX4SRC		04-	0,80	BKR6ES	3783	BKR6EIX	6418
90 hp - PL4STC, PX4STC, PL4STC, PX4STC		03-	0,80	BKR6ES	3783	BKR6EIX	6418
100 hp		66-	0,80	B6S	3510	-	-
100 hp - COM		84-01	-	BUHXW-1	5526	-	-
100 hp - CV4	4	79-97	0,80	BR6HS	3922	BR6HIX	3419
100 hp - Starfire		67-72	0,80	B7HS	5110	BR7HIX	7067
100 hp - V4		79-80	0,80	B7HS	5110	BR7HIX	7067
105 hp - COM LV4		97-03	0,80	BPZ8HS-10	3133	-	-
105 hp - LV6 105 Jet	6	93-03	0,80	BPZ8HS-10	3133	-	-
110 / 112 hp - CV4	4	79-97	0,80	BR7HS	4122	BR7HIX	7067
115 hp		69-70	0,80	B7HS	5110	BR7HIX	7067
115 hp		73-79	0,80	BZ7HS-10	3579	-	-
115 hp		85-	-	BUHXW-1	5526	-	-
115 hp		86-93	0,80	BZ7HS-10	3579	-	-
115 hp		06-	0,80	BPZ8HS-10	3133	-	-
115 hp - COM		75-84	0,80	B7HS	5110	BR7HIX	7067
115 hp - CV4		79-98	0,80	BR7HS	4122	BR7HIX	7067
115 hp - Fast Strike LV4	4	95-02	0,80	BPZ8HS-10	3133	-	-
115 hp - GLSOB, PLSOR, PXSOR, WPLSOC		05-	0,80	BPZ8HS-10	3133	-	-
115 hp - GLSRC, PLSRC, PXSRC, WPLSRS		04-	0,80	BPZ8HS-10	3133	-	-
115 hp - GLSTA, PLSTS, PXSTS		03-	0,80	BPZ8HS-10	3133	-	-
115 hp - L4SRC, 5X4SRC, PL4SRC, PX4SRC		04-	0,80	BKR6ES	3783	BKR6EIX	6418
115 hp - L4STS, X4STS, PL4STS, PX4STS		03-	0,80	BKR6ES	3783	BKR6EIX	6418
115 hp - LV4 F.F.I.		98-	0,80	PZFR6H	7696	-	-
115 hp - PL450R, PX450R		05-	0,80	BKR6ES	3783	BKR6EIX	6418
115 hp - Turbojet CV4		94-98	0,80	BR7HS	4122	BR7HIX	7067
115 hp - X-115		67-68	-	BUHW	2622	-	-
120 hp - LV4		85-03	0,80	BPZ8HS-10	3133	-	-
125 hp - 125 COM		71-72	0,80	B7HS	5110	BR7HIX	7067
130 hp - LV4		85-03	0,80	BPZ8HS-10	3133	-	-
135 hp - Starflite		73-84	-	BUHXW-1	5526	-	-
140 hp		73-84	-	BUHXW-1	5526	-	-
140 hp		03-05	0,80	BKR6ES	3783	BKR6EIX	6418
140 hp - LV4		85-02	0,80	BPZ8HS-10	3133	-	-
150 hp		03-06	0,80	BPZ8HS-10	3133	-	-
150 hp - Carb.		02-	0,80	BPZ8HS-10	3133	-	-
150 hp - CV6	6	78-87	-	BUHXW-1	5526	-	-
150 hp - CV6	6	88-91	0,80	BZ7HS-10	3579	-	-
150 hp - COM LV6	6	93-98	0,80	BPZ8HS-10	3133	-	-
150 hp - Fast Strike LV6	6	91-01	0,80	BPZ8HS-10	3133	-	-
150 hp - LV6 F.F.I.	6	97-98	0,80	PZFR6H	7696	-	-
155 hp - CV6	6	78-87	-	BUZ8H	7447	-	-
155 hp - COM CV6	6	89-92	-	BUZ8H	7447	-	-
175 hp		77-87	-	BUHXW-1	5526	-	-
175 hp		99-06	0,80	BPZ8HS-10	3133	-	-
175 hp - CV6	6	88-91	0,80	BZ7HS-10	3579	-	-
175 hp - Fast Strike LV6	6	91-02	0,80	BPZ8HS-10	3133	-	-
175 hp - LV6 F.F.I.	6	98-	0,80	PZFR6H	7696	-	-
185 hp		77-87	-	BUZ8H	7447	-	-
185 hp		90-93	0,80	BZ7HS-10	3579	-	-
200 hp		76-83	-	BUZ8H	7447	-	-
200 hp		04-05	0,80	BKR6ES	3783	BKR6EIX	6418
200 hp - COM		92-	-	BUZ8H	7447	-	-
200 hp - COM		93-98	0,80	BPZ8HS-10	3133	-	-
200 hp - LV6 DI	6	04-	0,80	PZFR6H	7696	-	-
200 hp - V6	6	86-93	0,80	BZ7HS-10	3579	-	-
200 hp - Venom LV6	6	94-03	0,80	BPZ8HS-10	3133	-	-
225 hp		04-05	0,80	BKR6ES	3783	BKR6EIX	6418
225 hp - LV6 DI	6	04-	0,80	PZFR6H	7696	-	-
225 hp - V6	6	86-93	0,80	BZ7HS-10	3579	-	-
225 hp - Venom LV6	6	94-01	0,80	BPZ8HS-10	3133	-	-
235 hp		78-85	-	BUHXW-1	5526	-	-
250 hp - LV6	6	99-01	-	BUHXW-1	5526	-	-
250 hp - LV6 Fict	6	00-03	0,80	PZFR6H	7696	-	-
250 hp - V8	8	85-97	0,80	BPZ8HS-10	3133	-	-
275 hp	8	85-88	0,80	BPR7HS	6422	BPR7HIX	5944
300 hp - V8	8	85-97	0,80	BPZ8HS-10	3133	-	-

LAURA



Modèle

Cyl.

N°
STOCKN°
STOCK IX

LAURA

Boatmaster	-	0,50	B6HS	4510	BR6HIX	3419
Boatmaster (Forte accélération)	-	0,80	BR6HS	3922	BR6HIX	3419

LEHR





2.5 hp - LP 2.5S - 72cc 4 temps OHV Propane	-	0,60	BR6HS	3922	BR6HIX	3419
5 hp - LP 5.0L / 5.0S - 112cc 4 temps OHV Propane	-	0,60	BR6HS	3922	BR6HIX	3419





MARINEPOWER





2 temps - 2.5 / 3.3 hp	-	1,00	BPR6HS-10	2633	-	-
2 temps - 4 / 5 hp	-	1,00	BPR7HS-10	1092	-	-
2 temps - 6 / 8 hp	-	1,00	BP8H-N-10	4838	-	-
2 temps - 9.9 / 10 / 15 hp	-	1,50	BP8HS-15	6729	-	-
2 temps - 20 / 25 hp	-	1,00	BP8H-N-10	4838	-	-
2 temps - 30 / 40 / 50 / 60 hp	-	1,00	BPZ8H-N-10	4495	-	-
2 temps - 75 / 75 Seapro Marathon / 90 hp	-	-	BUZH-W-2	2173	-	-
2 temps - 100 / 115 / 125 hp	-	1,00	BPZ8H-N-10	4495	-	-
2 temps - 135 / 150 / 175 / 200 hp	-99	0,70	BU8H	6431	-	-
2 temps - 140 / 150 / 175 / 200 hp	-03	1,00	BPZ8HS-10	3133	-	-
2 temps - 140 / 150 / 200 hp	04-	1,00	BPZ8H-N-10	4495	-	-
2 temps - 225 / 250 hp	-	0,70	BR8HS	4322	BR8HIX	7001
4 temps - 4 hp	-	0,60	DCPR6E	3481	DCPR6EIX	8196
4 temps - 5 / 6 hp	-	0,80	DCPR6E	3481	DCPR6EIX	8196
4 temps - 8 / 9.9 / 15 / 25 hp	-	0,90	DPR6EA-9	5531	-	-
4 temps - 30 hp / 40 hp EFI	-	0,90	DCPR7E	3932	DCPR7EIX	6046
4 temps - 30 hp Vergaser / 40 hp Vergaser / 50 hp	-	0,90	DPR6EA-9	5531	-	-
4 temps - 45 hp	-01	0,90	DPR6EA-9	5531	-	-
4 temps - 60 hp	-01	1,00	BPZ8H-N-10	4495	-	-
4 temps - 75 / 90 hp	-	1,10	LF5A-11	6376	LF5AIX-11	4469
4 temps - 115 hp	-	1,10	LF6A-11	3672	LF6AIX-11	6619
4 temps - 225 hp	04-	1,10	LF5A-11	6376	LF5AIX-11	4469
10 / 15 hp - Seapro Marathon	-	1,50	BP8HS-15	6729	-	-
75 / 90 / 115 hp - Optimax	04-	0,80	PZFR6H	7696	-	-
115 hp - Optimax	-00	1,10	PZFR5F-11	4363	-	-
135 / 150 / 175 / 225 hp - Optimax	-	1,10	PZFR5F-11	4363	-	-
210 hp - 210 Jetdrive / Sport Jet 175XR2	-	0,80	BUZ8H	7447	-	-
240 hp - Jetdrive	-	1,00	BPZ8HS-10	3133	-	-

MARINER

2.0 hp - 2A 646	-	0,60	B6HS	4510	BR6HIX	3419
2.0 hp - 2B 6A1 (->M-011600)	-	0,60	B6HS	4510	BR6HIX	3419
2.0 hp - 2B 6A1 (M-011601->)	-	0,60	B5HS	4210	-	-
2.5 hp	90-02	1,00	BPR6HS-10	2633	-	-
2.5 hp - 4 temps - Carb.	1	0,90	DCPR6E	3481	DCPR6EIX	8196
3.3 hp	93-02	1,00	BPR6HS-10	2633	-	-
3.5 hp - 642(->ML-41690)	-	0,60	B7HS	5110	BR7HIX	7067
3.5 hp - 642(ML-41691->)	-	0,60	B6HS	4510	BR6HIX	3419
3.5 hp - 642(->M-23740)	-	0,60	B7HS	5110	BR7HIX	7067
3.5 hp - 642(M-23741->)	-	0,60	B6HS	4510	BR6HIX	3419
3.5 hp - 4 temps - Carb.	1	0,90	DCPR6E	3481	DCPR6EIX	8196
3.6 hp	80-82	1,00	BP7HS-10	7829	-	-
4.0 hp - 2 temps	90-02	1,00	BPR7HS-10	1092	-	-
4.0 hp - 4 temps	99-02	0,90	DCPR6E	3481	DCPR6EIX	8196
4.0 hp - 4A 6E0	-	0,60	B7HS	5110	BR7HIX	7067
5.0 hp - 2 temps	90-02	1,00	BPR7HS-10	1092	-	-
5.0 hp - 4 temps	99-02	0,90	DCPR6E	3481	DCPR6EIX	8196
5.0 hp - 5A 661 / 5B 661 / 5C 6E3	-	0,60	B7HS	5110	BR7HIX	7067
6.0 hp - 2 temps	87-92	1,00	BP8HS-10	3823	-	-
6.0 hp - 2 temps	92-02	1,00	BP8H-N-10	4838	-	-
6.0 hp - 4 temps	00-02	0,90	DCPR6E	3481	DCPR6EIX	8196
6.0 hp - 6B 678	-	0,60	B5HS	4210	-	-
6.0 hp - 6C 6H8 / 6D 6H6	-	0,80	B7HS-10	2129	-	-
8.0 hp	87-92	1,00	BP8HS-10	3823	-	-
8.0 hp	93-02	1,00	BP8H-N-10	4838	-	-
8.0 hp - 4 temps	2	0,90	DCPR6E	3481	DCPR6EIX	8196
8.0 hp - 8.0 Bodensee	95-99	0,70	CR6HS	7023	CR6HIX	7274
8.0 hp - 8A 647 / 8A 655	-	0,60	B6HS	4510	BR6HIX	3419
8.0 hp - 8B 677	-	0,60	B7HS	5110	BR7HIX	7067
8.0 hp - 8C 6G1	-	0,80	B7HS-10	2129	-	-
8.0 hp - K8 680	91-00	0,60	B6HS	4510	BR6HIX	3419
8.0 hp - Marathon 8 677 / W8 677	-	0,60	B7HS	5110	BR7HIX	7067
9.9 hp	87-94	1,00	BP8HS-10	3823	-	-

	Modèle	Cyl.				N° STOCK		N° STOCK IX
9.9 hp			95-00	1,50	BP8HS-15	6729	-	-
9.9 hp - 9.9 4 temps			99-02	0,90	DPR6EA-9	5531	-	-
9.9 hp - 9.9 4 temps	2	-	-	0,90	DCPR6E	3481	DCPR6EIX	8196
9.9 hp - 9.9C 682			-	0,60	B7HS	5110	BR7HIX	7067
9.9 hp - 9.9C 682 w/CDI			-	0,80	B7HS-10	2129	-	-
9.9 hp - 4 temps Big Foot, Sail Power			95-02	0,70	CR6HS	7023	CR6HIX	7274
10 hp - Magnum			91-98	1,50	BP8HS-15	6729	-	-
10 hp - Marathon			91-02	1,50	BP8HS-15	6729	-	-
15 hp - 2 cyl.	2	89-02	1,50	BP8HS-15	6729	-	-	-
15 hp - 4 temps			98-02	0,90	DPR6EA-9	5531	-	-
15 hp - 4 temps	2	-	-	0,90	DCPR6E	3481	DCPR6EIX	8196
15 hp - 4 temps Bigfoot			98-	0,90	DPR6EA-9	5531	-	-
15 hp - 15A 651 / 15C 684			-	0,60	B7HS	5110	BR7HIX	7067
15 hp - 15C 684 w/CDI			-	0,80	B7HS-10	2129	-	-
15 hp - K15 669			-	0,60	B6HS	4510	BR6HIX	3419
15 hp - K15 6K4			84-00	0,80	B7HS-10	2129	-	-
15 hp - K15 6M7			-	0,80	B7HS-10	2129	-	-
15 hp - Marathon			92-96	1,00	BP8H-N-10	4838	-	-
15 hp - Marathon			97-02	1,50	BP8HS-15	6729	-	-
15 hp - Marathon 684 / W15 662			-	0,60	B7HS	5110	BR7HIX	7067
15 hp - Marathon 684 w/CDI / W15 684			-	0,90	B7HS-10	2129	-	-
20 hp			85-02	1,00	BP8H-N-10	4838	-	-
20 hp - 4 temps	2	-	-	0,90	DCPR6E	3481	DCPR6EIX	8196
20 hp - 20A 653			-	0,60	B6HS	4510	BR6HIX	3419
20 hp - 20C 6A9			-	0,60	B7HS	5110	BR7HIX	7067
20 hp - Jet			95-01	1,00	BP8H-N-10	4838	-	-
25 hp			85-01	1,00	BP8H-N-10	4838	-	-
25 hp			92-	-	BU8H	6431	-	-
25 hp - 4 temps - Ø12mm			98-02	0,90	DPR6EA-9	5531	-	-
25 hp - 25A 648 / 25B 690 / 25C 695			-	0,60	B7HS	5110	BR7HIX	7067
25 hp - EFI 4 temps	3	-	-	0,90	DCPR6E	3481	DCPR6EIX	8196
25 hp - K25 6A4			97-00	0,60	B7HS	5110	BR7HIX	7067
25 hp - Marathon			93-02	1,00	BP8H-N-10	4838	-	-
25 hp - Marathon 648 / 694 / 695			-	0,60	B7HS	5110	BR7HIX	7067
25 hp - W25 648 / 694 / 695			-	0,60	B7HS	5110	BR7HIX	7067
28 hp - 664			-	0,60	B7HS	5110	BR7HIX	7067
30 hp			95-00	1,00	BP8H-N-10	4838	-	-
30 hp - 2 cyl. 4 temps	2	99-02	0,90	DPR6EA-9	5531	-	-	-
30 hp - 30A 689			92-94	0,60	B7HS	5110	BR7HIX	7067
30 hp - EFI 4 temps BigFoot	3	99-	0,90	DPR6EA-9	5531	-	-	-
30 hp - Jet 3 cyl.	3	95-97	-	BUHW-2	5626	-	-	-
30 hp - Jet 3 cyl.	3	98-01	1,00	BP8H-N-10	4838	-	-	-
30 hp - Marathon			95-02	1,00	BP8H-N-10	4838	-	-
30 hp - Marathon 698B			-	0,60	B7HS	5110	BR7HIX	7067
30 hp - W30 689A / W30 689B			92-93	0,60	B7HS	5110	BR7HIX	7067
40 hp - 2 cyl.	2	89-97	-	BUHW-2	5626	-	-	-
40 hp - 2 cyl.	2	98-01	1,00	BP8H-N-10	4838	-	-	-
40 hp - 3 cyl.	3	98-01	1,00	BP8H-N-10	4838	-	-	-
40 hp - 3 cyl. 4 temps	3	98-01	0,90	DPR6EA-9	5531	-	-	-
40 hp - 40A 676A			-	0,60	B8HS	4322	BR8HIX	7001
40 hp - 40B 675B			-	0,60	B8HS	5510	BR8HIX	7001
40 hp - 40C 6E9			81-94	0,60	B8HS	5510	BR8HIX	7001
40 hp - A 676A			-	0,60	B8HS	5510	BR8HIX	7001
40 hp - K40 6F5 2 cyl.	2	84-00	0,60	B7HS	5110	BR7HIX	7067	-
40 hp - Marathon 2 cyl.	2	95-02	1,00	BP8H-N-10	4838	-	-	-
40 hp - Marathon 6F6			85-94	0,60	B7HS	5110	BR7HIX	7067
40 hp - W40 6F6			-	0,60	B7HS	5110	BR7HIX	7067
40 hp - W40 676A			-	0,60	B8HS	5510	BR8HIX	7001
45 hp - 3 cyl. Jet	3	95-01	1,00	BP8H-N-10	4838	-	-	-
45 hp - 4 cyl.	4	86-89	-	BUHW-2	5626	-	-	-
45 hp - 4 cyl. Bodensee	4	95-98	0,90	DPR6EA-9	5531	-	-	-
48 hp - 670 / W48 670			-	0,60	B7HS	5110	BR7HIX	7067
50 hp			91-01	1,00	BP8H-N-10	4838	-	-
50 hp - 3 cyl.	3	86-90	-	BUHW	2622	-	-	-
50 hp - 4 cyl.	4	80-85	-	BUHW-2	5626	-	-	-
50 hp - 4 cyl. 4 temps	4	95-01	0,90	DPR6EA-9	5531	-	-	-
55 hp - M55 663 (-> EL-315378)			-	0,60	B8HS	5510	BR8HIX	7001
55 hp - M55 663 (EL-315379->)			-	0,90	B8HS-10	5126	-	-
55 hp - M55 663 (-> E-004040)			-	0,60	B8HS	5510	BR8HIX	7001
55 hp - M55 663 (E-004041->)			-	0,90	B8HS-10	5126	-	-
55 hp - Marathon			91-02	1,00	BP8H-N-10	4838	-	-
55 hp - Marathon 55 663 / W55 663			-	0,60	B8HS	5510	BR8HIX	7001
60 hp			91-01	1,00	BP8H-N-10	4838	-	-
60 hp - 3 cyl. 849 cc	3	84-90	-	BUHW	2622	-	-	-
60 hp - 6F0			-	0,90	B8HS-10	5126	-	-

 Modèle	Cyl.				N° STOCK		N° STOCK IX
60 hp - 675 (->L302050)		-	0,60	B8HS	5510	BR8HIX	7001
60 hp - 675 (L302051->)		-	0,90	B8HS-10	5126	-	-
60 hp - 675 (->S-000780)		-	0,60	B8HS	5510	BR8HIX	7001
60 hp - 675 (S-000781->)		-	0,90	B8HS-10	5126	-	-
60 hp - Big Foot		95-99	1,00	BP8H-N-10	4838	-	-
60 hp - Marathon		95-02	1,00	BP8H-N-10	4838	-	-
65 hp - Jet		95-01	-	BUHW-2	5626	-	-
70 hp - 3 cyl.	3	-	-	BUHW	2622	-	-
75 hp		87-01	-	BUHW-2	5626	-	-
75 hp - 3 cyl. 1.5L DFI	3	-	0,80	IZFR5J	5899	-	-
75 hp - 4 cyl.	4	-	-	BUHW-2	5626	-	-
75 hp - 4 temps		00-	1,10	LFR5A-11	6376	LFR5AIX-11	4469
75 hp - Marathon		91-02	-	BUHW-2	5626	-	-
80 hp - 4 cyl.	4	-	-	BUHW-2	5626	-	-
80 hp - 80 Jet		95-01	1,00	BP8H-N-10	4838	-	-
85 hp		-	-	BUHW-2	5626	-	-
90 hp		-	-	BUHW	2622	-	-
90 hp		87-01	-	BUHW-2	5626	-	-
90 hp - 3 cyl. 1.5L DFI	3	-	0,80	IZFR5J	5899	-	-
90 hp - 4 temps		00-	1,10	LFR5A-11	6376	LFR5AIX-11	4469
100 hp		88-99	1,00	BP8H-N-10	4838	-	-
105 hp - Jet 6 cyl.	6	95-99	-	BU8H	6431	-	-
115 hp		77-88	-	BUHW	2622	-	-
115 hp - 3 cyl. 1.5L DFI	3	-	0,80	IZFR5J	5899	-	-
115 hp - 4 cyl. 2 temps	4	89-02	1,00	BP8H-N-10	4838	-	-
115 hp - 115 Optimax		00-04	1,00	PZFR5F-11	4363	-	-
125 hp		94-02	1,00	BP8H-N-10	4838	-	-
135 hp		86-99	-	BU8H	6431	-	-
135 hp		00-01	1,00	BPZ8HS-10	3133	-	-
135 hp - Marathon		86-99	-	BU8H	6431	-	-
135 hp - Optimax		98-02	1,00	PZFR5F-11	4363	-	-
135 hp - Verado 4 temps	4	-	0,70	ILFR6G	5588	-	-
135 hp - Work		86-93	-	BU8H	6431	-	-
140 hp - 6 cyl.	6	-	-	BUHW	2622	-	-
140 hp - Jet		95-99	-	BU8H	6431	-	-
150 hp		79-99	-	BU8H	6431	-	-
150 hp		00-01	1,00	BPZ8HS-10	3133	-	-
150 hp - EFI		97-99	-	BU8H	6431	-	-
150 hp - EFI		00-01	1,00	BPZ8HS-10	3133	-	-
150 hp - Magnum		-	-	BU8H	6431	-	-
150 hp - Magnum II		88-91	-	BU8H	6431	-	-
150 hp - Magnum III		92-97	-	BU8H	6431	-	-
150 hp - Magnum EFI		93-97	-	BU8H	6431	-	-
150 hp - Optimax		97-02	1,00	PZFR5F-11	4363	-	-
150 hp - Verado 4 temps	4	-	0,70	ILFR6G	5588	-	-
150 hp - Work		-	-	BU8H	6431	-	-
175 hp		78-98	-	BU8H	6431	-	-
175 hp - EFI		98-99	-	BU8H	6431	-	-
175 hp - EFI		00-	1,00	BPZ8HS-10	3133	-	-
175 hp - Magnum EFI		91-97	-	BU8H	6431	-	-
175 hp - Ski		89-94	-	BU8H	6431	-	-
175 hp - Verado 4 temps	4	-	0,70	ILFR6G	5588	-	-
200 hp		79-99	-	BU8H	6431	-	-
200 hp		00-	1,00	BPZ8HS-10	3133	-	-
200 hp - DFI 3.0L		97-	1,00	PZFR6H	7696	-	-
200 hp - EFI		98-99	-	BU8H	6431	-	-
200 hp - EFI		00-	1,00	BPZ8HS-10	3133	-	-
200 hp - Magnum EFI		89-97	-	BU8H	6431	-	-
200 hp - Optimax		97-04	1,00	PZFR5F-11	4363	-	-
200 hp - Super Magnum EFI		97-	-	BU8H	6431	-	-
200 hp - Verado 4 temps	6	-	0,70	ILFR6G	5588	-	-
220 hp - Magnum EFI		87-88	-	BU8H	6431	-	-
225 hp		94-00	1,00	BR8HS	4322	BR8HIX	7001
225 hp - 3.0L Marathon		97-01	0,90	BR8HS	4322	BR8HIX	7001
225 hp - EFI		95-00	0,90	BR8HS	4322	BR8HIX	7001
225 hp - Optimax		98-04	1,00	PZFR5F-11	4363	-	-
225 hp - Super Magnum EFI		97-	-	BU8H	6431	-	-
225 hp - Verado 4 temps	6	-	0,70	ILFR6G	5588	-	-
250 hp - 3.4L		89-90	-	BU8H	6431	-	-
250 hp - Magnum EFI		96-01	0,90	BR8HS	4322	BR8HIX	7001
250 hp - Pro Verado 4 temps	6	-	0,70	ILFR6G-E	4212	-	-
250 hp - Verado 4 temps	6	-	0,70	ILFR6G	5588	-	-
260 hp - 2.5L EFI		95-98	-	BU8H	6431	-	-
265 hp - 2.5L EFI		97-	-	BU8H	6431	-	-
275 hp - 275 3.4L		91-94	-	BU8H	6431	-	-

Modèle	Cyl.				N° STOCK		N° STOCK IX
275 hp - 275 Verado 4 temps	6	-	0,70	ILFR6G	5588	-	-
300 hp - 2.5L Drag EFI V6	6	97-98	-	BUZHW	2147	-	-
300 hp - 3.0L Super Magnum EFI		97-98	0,80	BZ7HS-10	3579	-	-
300 hp - Verado / Pro Verado 4 temps	6	-	0,70	ILFR6G-E	4212	-	-

MARTIN

20 (2 PS), 40 / 45 (4.5PS)	-	0,90	B6S	3510	-	-
60 / 66 (7.2PS), 75 (7.5PS), 100 (10PS)	-	0,90	B6S	3510	-	-

MCCULLOCH

3.5 hp, 4.0 hp - Arbre long, 7.5 hp	64-69	0,80	B-6L	3212	-	-
4 PS	-	0,90	BP5S	3011	-	-
9 PS	-	0,90	BM6A	5921	-	-
9.5 / 14 / 28 / 45 PS	-	0,90	B6S	3510	-	-
9.9 hp	-	0,80	BM6A	5921	-	-
75 hp	-	0,80	B6S	3510	-	-
590 / 630	-	0,90	B6S	3510	-	-

MEDINA

Tous modèles	-	0,80	B6HS	4510	BR6HIX	3419
--------------	---	------	------	------	--------	------

MERCURY

2.0L F1 Carb/EFI High Performance Engine	-	-	BUHW	2622	-	-
2.4L Bass/EFI High Performance Engine	-	-	BUHW	2622	-	-
2.4L Mod VP High Performance Engine	-	-	BUHW	2622	-	-
2.5L Carb High Performance Engine	91-93	-	BUHW	2622	-	-
2.5L EFI High Performance Engine	94-97	-	BUZHW	2147	-	-
10X High Performance Engine	-	1,00	BP8HS-10	3823	-	-
21.9 cu in 25SS Racing	-	-	BUHW	2622	-	-
25SS / 44XS High Performance Engine	-	-	BUHW-2	5626	-	-
25XS High Performance Engine	-	-	BUHW	2622	-	-
49.9 cid 650X Racing	-	-	BUHW	2622	-	-
99.9 cid Twister 11-X Racing	-	-	BUHW	2622	-	-
150 Magnum Pro Max Super	-	-	BUHW	2622	-	-
200 / 225 Magnum EFI Pro Max Super	-	-	BUHW	2622	-	-
SST 140 High Performance Engine	-	-	BUHW	2622	-	-
XR-2 Magnum High Performance Engine	-	-	BUHW	2622	-	-
2.2 hp - 2 temps	84-94	1,00	BPR6HS-10	2633	-	-
2.5 hp	06-	1,00	BPR6HS-10	2633	-	-
2.5 hp - 4 temps 85cc	1 06-11	0,90	DCPR6E	3481	DCPR6EIX	8196
2.5 hp - Classic	1 93-05	1,00	BP6HS-10	6326	-	-
3.0 hp	90-92	1,00	BPR6HS-10	2633	-	-
3.3 hp	93-06	1,00	BPR6HS-10	2633	-	-
3.5 hp	83-85	1,00	BP6HS-10	6326	-	-
3.5 hp - 4 temps 85cc	1 06-11	0,90	DCPR6E	3481	DCPR6EIX	8196
3.6 hp	80-82	1,00	BP7HS-10	7829	-	-
3.9 hp	64-66	0,60	B6S	3510	-	-
3.9 hp	67-68	0,80	B5HS	4210	-	-
4.0 hp	69-69	0,80	B5HS	4210	-	-
4.0 hp	70-74	-	BUHW-2	5626	-	-
4.0 hp	80-82	0,90	BP7HS	5111	BPR7HIX	5944
4.0 hp	86-87	-	BUHW-2	5626	-	-
4.0 hp - 2 temps Classic	88-06	1,00	BPR7HS-10	1092	-	-
4.0 hp - 4 temps 123cc	1 00-11	0,90	DCPR6E	3481	DCPR6EIX	8196
4.0 hp - 40 Gnat	76-79	0,80	BR6HS	3922	BR6HIX	3419
4.5 hp	75-85	-	BUHW-2	5626	-	-
5.0 hp - 2 temps Classic	88-06	1,00	BPR7HS-10	1092	-	-
5.0 hp - 4 temps 123cc	1 00-06	0,90	DCPR6E	3481	DCPR6EIX	8196
6.0 hp	63-66	0,60	B6S	3510	-	-
6.0 hp	67-68	0,80	B6HS	4510	BR6HIX	3419
6.0 hp - 2 temps	86-00	1,00	BP8H-N-10	4838	-	-
6.0 hp - 2 temps	01-06	1,00	BPZ8H-N-10	4495	-	-
6.0 hp - 4 temps 123cc	1 00-11	0,90	DCPR6E	3481	DCPR6EIX	8196
7.5 hp	69-	0,80	B6HS	4510	BR6HIX	3419
7.5 hp	70-73	-	BUHW-2	5626	-	-
7.5 hp	74-	-	BUHW	2622	-	-
7.5 hp	75-78	-	BUHW-2	5626	-	-
7.5 hp	79-85	1,00	B9HS-10	3626	-	-
8.0 hp - 2 temps	86-00	1,00	BP8H-N-10	4838	-	-
8.0 hp - 2 temps	01-06	1,00	BPZ8H-N-10	4495	-	-
8.0 hp - 2 temps Bodensee	95-02	0,70	CR6HS	7023	CR6HIX	7274
8.0 hp - 4 temps	06-	0,90	DCPR6E	3481	DCPR6EIX	8196
8.0 hp - 208cc	2 05-11	0,90	DCPR6E	3481	DCPR6EIX	8196



Modèle

Cyl.







N° STOCK



N° STOCK IX

9.8 hp		79-85	1,00	B9HS-10	3626	-	-
9.8 hp - 100		60-61	0,60	B6S	3510	-	-
9.8 hp - 110		62-66	0,60	B6S	3510	-	-
9.8 hp - 110		67-69	0,80	B7HS	5110	BR7HIX	7067
9.8 hp - 110		70-73	-	BUHW-2	5626	-	-
9.8 hp - 110		74	-	BUHW	2622	-	-
9.8 hp - 110		75-78	-	BUHW-2	5626	-	-
9.9 hp - 2 temps		86-94	1,00	BP8H-N-10	4838	-	-
9.9 hp - 2 temps		95-00	1,50	BP8HS-15	6729	-	-
9.9 hp - 2 temps		01-06	1,50	BPZ8HS-15	3180	-	-
9.9 hp - 4 temps		95-98	0,70	CR6HS	7023	CR6HIX	7274
9.9 hp - 4 temps		99-02	0,90	DPR6EA-9	5531	-	-
9.9 hp - 4 temps		06-	0,90	DCPR6E	3481	DCPR6EIX	8196
9.9 hp - 208cc Bigfoot, Prockicker	2	01-11	0,90	DCPR6E	3481	DCPR6EIX	8196
10 hp		91-	1,50	BP8HS-15	6729	-	-
10 hp - 10 Sea Pro		91-00	1,50	BP8HS-15	6729	-	-
10 hp - 10 Sea Pro		01-02	1,50	BPZ8HS-15	3180	-	-
10 hp - XR10		92-98	1,50	BP8HS-15	6729	-	-
15 hp - 150		60-61	0,60	B6S	3510	-	-
15 hp - 2 temps		89-00	1,50	BP8HS-15	6729	-	-
15 hp - 2 temps		01-06	1,50	BPZ8HS-15	3180	-	-
15 hp - 4 temps Bigfoot 323cc		98-06	0,90	DPR6EA-9	5531	-	-
15 hp - 4 temps Bigfoot, Prockicker 351cc	2	07-11	0,90	DCPR6E	3481	DCPR6EIX	8196
15 hp - Sea Pro		95-96	1,00	BP8HS-10	3823	-	-
15 hp - Sea Pro 2 temps		97-00	1,50	BP8HS-15	6729	-	-
15 hp - Sea Pro 2 temps		01-02	1,50	BPZ8HS-15	3180	-	-
18 hp		81-83	1,00	BP8H-N-10	4838	-	-
18 hp - 18 XD		84-85	1,00	BP8H-N-10	4838	-	-
20 hp		79-80	-	BUHW-2	5626	-	-
20 hp - 4 temps (Carb.)	2	-	0,80	DCPR6E	3481	DCPR6EIX	8196
20 hp - 200		60-61	0,60	B6S	3510	-	-
20 hp - 200		63-66	0,60	B6S	3510	-	-
20 hp - 200		67-69	0,80	B7HS	5110	BR7HIX	7067
20 hp - 200		70-78	-	BUHW-2	5626	-	-
20 hp - 351cc	2	08-11	0,90	DCPR6E	3481	DCPR6EIX	8196
20 hp - 2 temps	2	86-00	1,00	BP8H-N-10	4838	-	-
20 hp - 2 temps	2	01-06	1,00	BPZ8H-N-10	4495	-	-
20 hp - Jet 2 temps		95-00	1,00	BP8H-N-10	4838	-	-
20 hp - Jet 2 temps		01-02	1,00	BPZ8H-N-10	4495	-	-
20 hp - Sea Pro 2 temps		01-	1,00	BPZ8H-N-10	4495	-	-
25 hp		80-83	1,00	BP8H-N-10	4838	-	-
25 hp		86-92	1,00	BP8H-N-10	4838	-	-
25 hp - 2 temps		93-00	1,00	BP8H-N-10	4838	-	-
25 hp - 2 temps		01-06	1,00	BPZ8H-N-10	4495	-	-
25 hp - 4 temps		98-01	0,90	DPR6EA-9	5531	-	-
25 hp - 4 temps EFI		06-	0,90	DCPR6E	3481	DCPR6EIX	8196
25 hp - 25 EFI 526cc	3	06-11	0,90	DCPR6E	3481	DCPR6EIX	8196
25 hp - 25 XD		84-85	1,00	BP8H-N-10	4838	-	-
25 hp - 250		62-	0,60	B6S	3510	-	-
25 hp - Sea Pro 2 temps		93-02	1,00	BP8H-N-10	4838	-	-
30 hp - 2 cyl. 2 temps	2	95-02	1,00	BP8H-N-10	4838	-	-
30 hp - 2 cyl. 2 temps	2	01-	1,00	BPZ8H-N-10	4495	-	-
30 hp - 2 cyl. 4 temps	2	99-02	0,90	DPR6EA-9	5531	-	-
30 hp - 3cyl.	3	95-97	-	BUHW-2	5626	-	-
30 hp - 3 cyl. 2 temps	3	01-	1,00	BPZ8H-N-10	4495	-	-
30 hp - 3 cyl. 4 temps EFI	3	06-	0,90	DCPR7E	3932	DCPR7EIX	6046
30 hp - 30 EFI 526cc	3	99-11	0,90	DPR6EA-9	5531	-	-
30 hp - 300 4 cyl.	4	60-	0,60	B6S	3510	-	-
30 hp - Jet 2 cyl. 2 temps	2	01-02	1,00	BPZ8H-N-10	4495	-	-
30 hp - Jet 3 cyl. 2 temps	3	98-01	1,00	BP8H-N-10	4838	-	-
30 hp - Sea Pro 2 cyl. 2 temps	2	95-00	1,00	BP8H-N-10	4838	-	-
30 hp - Sea Pro 2 cyl. 2 temps	2	01-02	1,00	BPZ8H-N-10	4495	-	-
35 hp		84-91	-	BUHW	2622	-	-
35 hp - 350		61-66	0,60	B7S	3710	-	-
35 hp - 350		63-65	0,60	B6S	3510	-	-
35 hp - 350		67-69	0,80	B7HS	5110	BR7HIX	7067
35 hp - 350 4 cyl.	4	61-	0,60	B6S	3510	-	-
40 hp - 2 cyl.	2	79-83	-	BUHW	2622	-	-
40 hp - 2 cyl. 2 temps	2	95-02	1,00	BP8H-N-10	4838	-	-
40 hp - 2 cyl. 2 temps	2	01-	1,00	BPZ8H-N-10	4495	-	-
40 hp - 2 cyl. 2 temps Sea Pro	2	95-00	1,00	BP8H-N-10	4838	-	-
40 hp - 2 cyl. 2 temps Sea Pro	2	01-06	1,00	BPZ8H-N-10	4495	-	-
40 hp - 3 cyl. 2 temps	3	98-02	1,00	BP8H-N-10	4838	-	-
40 hp - 3 cyl. 2 temps	3	01-02	1,00	BPZ8H-N-10	4495	-	-
40 hp - 3 cyl. 4 temps	3	98-02	0,90	DPR6EA-9	5531	-	-

	Modèle	Cyl.				N° STOCK		N° STOCK IX
40 hp - 4 cyl. 4 temps Big Foot		4	01-06	0,90	DPR6EA-9	5531	-	-
40 hp - 3 cyl. 4 temps EFI		3	06-	0,90	DCPR7E	3932	DCPR7EIX	6046
40 hp - 4 cyl.		4	88-97	-	BUHW-2	5626	-	-
40 hp - 4 cyl. 4 temps EFI		4	06-	0,90	DCPR7E	3932	DCPR7EIX	6046
40 hp - 4 cyl. 4 temps EFI, Bigfoot 995cc		4	07-11	0,90	DCPR6E	3481	DCPR6EIX	8196
40 hp - 400			60-61	0,60	B6S	3510	-	-
40 hp - 400			70-71	-	BUHW	2622	-	-
40 hp - 402			72-78	-	BUHW	2622	-	-
45 hp			86-89	-	BUHW-2	5626	-	-
45 hp - 450			62-	0,60	B6S	3510	-	-
45 hp - Bodensee 4 cyl. 4 temps		4	95-02	0,90	DPR6EA-9	5531	-	-
45 hp - Jet 3 cyl. 2 temps		3	95-00	1,00	BP8H-N-10	4838	-	-
45 hp - Jet 3 cyl. 2 temps		3	01-02	1,00	BPZ8H-N-10	4495	-	-
50 hp - 3 cyl.		3	86-90	-	BUHW	2622	-	-
50 hp - 3 cyl. 2 temps		3	91-00	1,00	BP8H-N-10	4838	-	-
50 hp - 3 cyl. 2 temps		3	01-06	1,00	BPZ8H-N-10	4495	-	-
50 hp - 4 cyl.		4	79-85	-	BUHW-2	5626	-	-
50 hp - 4 cyl. 4 temps Bigfoot		4	95-01	0,90	DPR6EA-9	5531	-	-
50 hp - 4 cyl. 4 temps EFI		4	06-	0,90	DCPR7E	3932	DCPR7EIX	6046
50 hp - 4 cyl. 4 temps EFI, Bigfoot 995cc		4	06-11	0,90	DCPR6E	3481	DCPR6EIX	8196
50 hp - 500			61-64	0,60	B6S	3510	-	-
50 hp - 500			65-66	0,60	B7S	3710	-	-
50 hp - 500			68-77	-	BUHW	2622	-	-
50 hp - 500			78-	-	BUHW-2	5626	-	-
50 hp - 500M / 500S			67-	0,80	B7HS	5110	BR7HIX	7067
50 hp - 500SS			67-	-	BUHW	2622	-	-
55 hp - Sea Pro 3 cyl. 2 temps		3	92-00	1,00	BP8H-N-10	4838	-	-
55 hp - Sea Pro 3 cyl. 2 temps		3	01-06	1,00	BPZ8H-N-10	4495	-	-
60 hp - 3 cyl. 2 temps		3	91-02	1,00	BP8H-N-10	4838	-	-
60 hp - 3 cyl. 2 temps		3	01-06	1,00	BPZ8H-N-10	4495	-	-
60 hp - 3 cyl. 2 temps Sea Pro		3	95-00	1,00	BP8H-N-10	4838	-	-
60 hp - 3 cyl. 2 temps Sea Pro		3	01-02	1,00	BPZ8H-N-10	4495	-	-
60 hp - 4 cyl. 4 temps		4	01-	0,90	DPR6EA-9	5531	-	-
60 hp - 4 cyl. 4 temps EFI		4	06-	0,90	DCPR7E	3932	DCPR7EIX	6046
60 hp - 4 cyl. 4 temps EFI, Big Foot 995cc		4	01-11	0,90	DCPR6E	3481	DCPR6EIX	8196
60 hp - 6 cyl. 600		6	60-	0,60	B6S	3510	-	-
60 hp - 60			84-90	-	BUHW	2622	-	-
60 hp - Big Foot			95-02	1,00	BP8H-N-10	4838	-	-
60 hp - Jet			-	-	BUZHW-2	2173	-	-
65 hp - 650			63-66	0,60	B7S	3710	-	-
65 hp - 650			72-76	-	BUHW	2622	-	-
65 hp - 650S			67-	0,80	B7HS	5110	BR7HIX	7067
65 hp - 650S			68-71	-	BUHW	2622	-	-
65 hp - 650SS			67-71	-	BUH	2422	-	-
65 hp - Jet 3 cyl. 2 temps		3	95-00	-	BUHW-2	5626	-	-
65 hp - Jet 3 cyl. 2 temps		3	01-02	-	BUZHW-2	2173	-	-
70 hp			79-83	-	BUHW	2622	-	-
70 hp			87-89	-	BUHW-2	5626	-	-
70 hp - 700			60-61	0,60	B6S	3510	-	-
70 hp - 700			77-78	-	BUHW	2622	-	-
75 hp - 3 cyl. 2 temps		3	87-00	-	BUHW-2	5626	-	-
75 hp - 3 cyl. 2 temps		3	01-06	-	BUZHW-2	2173	-	-
75 hp - 3 cyl. 2 temps Jet		3	01-	-	BUZHW-2	2173	-	-
75 hp - 3 cyl. 2 temps Sea Pro		3	91-01	-	BUHW-2	5626	-	-
75 hp - 3 cyl. Optimax 1.5L		3	03-11	0,80	IZFR5J	5899	-	-
75 hp - 4 cyl. 4 temps DOHC		4	00-06	1,10	LFR5A-11	6376	LFR5AIX-11	4469
75 hp - 4 cyl. 4 temps EFI 1.7L		4	-	1,10	-	-	LFR5AIX-11	4469
75 hp - 4 cyl. 75XD		4	84-86	-	BUHW-2	5626	-	-
75 hp - Walleye Moteur L4NA			07-	0,80	LFR4A-E	6499	-	-
80 hp - 3 cyl.		4	87-89	-	BUHW-2	5626	-	-
80 hp - 4 cyl.		4	79-83	-	BUHW-2	5626	-	-
80 hp - 4 cyl. 2 temps Jet		4	95-00	1,00	BP8H-N-10	4838	-	-
80 hp - 4 cyl. 2 temps Jet		4	01-	1,00	BPZ8H-N-10	4495	-	-
80 hp - 800			69-	-	BUHW	2622	-	-
80 hp - 800			78-	-	BUHW-2	5626	-	-
80 hp - 800 6 cyl.		6	60-61	0,60	B7S	3710	-	-
85 hp - 850			73-77	-	BUHW	2622	-	-
85 hp - 850 6 cyl.		6	62-64	0,60	B7S	3710	-	-
90 hp			87-98	-	BUHW-2	5626	-	-
90 hp - 3 cyl.		3	99-00	-	BUZHW-2	2173	-	-
90 hp - 3 cyl. 2 temps		3	01-06	-	BUZHW-2	2173	-	-
90 hp - 3 cyl. Optimax 1.5L		3	03-11	0,80	IZFR5J	5899	-	-
90 hp - 4 cyl. 4 temps DOHC		4	00-06	1,10	LFR5A-11	6376	LFR5AIX-11	4469
90 hp - 4 cyl. 4 temps EFI		4	00-11	1,10	LFR5A-11	6376	LFR5AIX-11	4469
90 hp - 6 cyl.		6	79-86	-	BUHW	2622	-	-

MERCURY

Modèle

Cyl.





N° STOCK



N° STOCK IX

90 hp - 900		65-	0,60	B7S	3710	-	-
90 hp - 900		78-	-	BUHW	2622	-	-
90 hp - Walleye Moteur L4NA		07-	0,80	LFR4A-E	6499	-	-
95 hp - 950		66-	0,80	B7HS	5110	BR7HIX	7067
95 hp - 950SS		66-67	-	BUHW	2622	-	-
100 hp - 100		88-99	1,00	BP8H-N-10	4838	-	-
100 hp - 1000		62-64	0,60	B7S	3710	-	-
100 hp - 1000 BP / SS		68-69	-	BUHW	2622	-	-
105 hp - 105 Jet		95-98	-	BU8H	6431	-	-
110 hp - 1100		66-	0,80	B7HS	5110	BR7HIX	7067
110 hp - 1100SS		66-67	-	BUHW	2622	-	-
115 hp - 4 cyl. 2 temps	4	89-00	1,00	BP8H-N-10	4838	-	-
115 hp - 4 cyl. 2 temps	4	01-06	1,00	BPZ8H-N-10	4495	-	-
115 hp - 6 cyl.	6	79-88	-	BUHW	2622	-	-
115 hp - 1150		70-78	-	BUHW	2622	-	-
115 hp - EFI MFI - 4 cyl. 4 temps	4	01-06	1,10	LFR6A-11	3672	LFR6AIX-11	6619
115 hp - Optimax		06-	0,80	IZFR5J	5899	-	-
115 hp - Optimax 6 cyl. 2 temps	6	00-02	1,00	PZFR5F-11	4363	-	-
115 hp - Optimax 6 cyl. 2 temps	6	03-04	0,80	IZFR5G	5887	-	-
115 hp - Walleye Moteur L4NA		07-	0,80	LFR4A-E	6499	-	-
125 hp - 4 cyl. 2 temps	4	94-00	1,00	BP8H-N-10	4838	-	-
125 hp - 4 cyl. 2 temps	4	01-06	1,00	BPZ8H-N-10	4495	-	-
125 hp - 1250 BP / SS		68-69	-	BUHW	2622	-	-
135 hp		86-99	-	BU8H	6431	-	-
135 hp - 1350		70-71	-	BUHW	2622	-	-
135 hp - 6 cyl. 2 temps	6	00-02	1,00	BPZ8HS-10	3133	-	-
135 hp - 6 cyl. 2 temps Optimax DFI	6	96-01	1,00	PZFR5F-11	4363	-	-
135 hp - 6 cyl. 2 temps Optimax DFI	6	03-06	0,80	IZFR5G	5887	-	-
135 hp - 6 cyl. 4 temps EFI Supercharged	6	06-	0,80	ILFR6G-E	4212	-	-
140 hp - 140		79-80	-	BUHW	2622	-	-
140 hp - 140 Jet		95-99	-	BU8H	6431	-	-
140 hp - 1400		70-78	-	BUHW	2622	-	-
150 hp		91-99	-	BU8H	6431	-	-
150 hp - 150		79-84	-	BU8H	6431	-	-
150 hp - 150		00-06	1,00	BPZ8HS-10	3133	-	-
150 hp - 150 EFI		98-99	-	BU8H	6431	-	-
150 hp - 150 EFI - 6 cyl. 2 temps	6	00-06	1,00	BPZ8HS-10	3133	-	-
150 hp - 150 EFI - 6-cyl. 4 temps, Supercharged	6	06-	0,80	ILFR6G-E	4212	-	-
150 hp - 150 Marathon		85-88	-	BU8H	6431	-	-
150 hp - 150 Optimax DFI 6 cyl. 2 temps	6	96-02	1,00	PZFR5F-11	4363	-	-
150 hp - 150 Optimax DFI 6 cyl. 2 temps	6	03-06	0,80	IZFR5G	5887	-	-
150 hp - 150 Optimax Pro XS 2.5L	6	03-11	0,80	IZFR5G	5887	-	-
150 hp - 150 Verado 4 temps 1.7L	4	06-11	1,10	-	-	LFR5AIX-11	4469
150 hp - 150 XR-2 / 150 XR-4		85-02	-	BU8H	6431	-	-
150 hp - 150 XR-6		92-97	-	BU8H	6431	-	-
150 hp - 150 XRi		93-02	-	BU8H	6431	-	-
150 hp - 1500		73-77	-	BUHW	2622	-	-
150 hp - 1500		78-	-	BU8H	6431	-	-
175 hp		76-78	-	BUHW	2622	-	-
175 hp		79-98	-	BU8H	6431	-	-
175 hp - 175 EFI		98-99	-	BU8H	6431	-	-
175 hp - 175 EFI 6 cyl. 4 temps, Supercharged	6	06-	0,80	ILFR6G-E	4212	-	-
175 hp - 175 EFI MFI 6 cyl. 2 temps	6	00-01	1,00	BPZ8HS-10	3133	-	-
175 hp - 175 EFI Verado 4 cyl. 4 temps 1.7L	4	05-11	0,80	ILFR6G-E	4212	-	-
175 hp - 175 Optimax DFI 6 cyl. 2 temps	6	01-02	1,00	PZFR5F-11	4363	-	-
175 hp - 175 Optimax DFI 6 cyl. 2 temps	6	03-06	0,80	IZFR5G	5887	-	-
175 hp - 175 Optimax Pro XS 6 cyl. 2 temps	6	03-11	0,80	IZFR5G	5887	-	-
175 hp - 175 XRi		91-02	-	BU8H	6431	-	-
200 hp - 2.0L Ducee High EFI		97-	-	BUZ8H	7447	-	-
200 hp - 2.0L F1 EFI		97-	-	BUZHW	2147	-	-
200 hp - 2.0L SST 120 EFI / 2.0L XR2 SS EFI		97-	-	BUHW	2622	-	-
200 hp - 6 cyl. 2 temps	6	00-06	1,00	BPZ8HS-10	3133	-	-
200 hp - 200		79-99	-	BU8H	6431	-	-
200 hp - 200 DFI		97-	1,00	PZFR6H	7696	-	-
200 hp - 200 EFI		98-99	-	BU8H	6431	-	-
200 hp - 200 EFI 4 temps		06-	0,80	ILFR6G	5588	-	-
200 hp - 200 EFI 6 cyl. 2 temps	6	06-	1,00	BR8HS	4322	BR8HIX	7001
200 hp - 200 EFI MFI 6 cyl. 2 temps	6	00-06	1,00	BPZ8HS-10	3133	-	-
200 hp - 200 Optimax 6 cyl. 2 temps	6	96-02	1,00	PZFR5F-11	4363	-	-
200 hp - 200 Optimax 6 cyl. 2 temps	6	03-06	0,80	IZFR5G	5887	-	-
200 hp - 200 Optimax XS 6 cyl.	6	02-04	1,00	PZFR5F-11	4363	-	-
200 hp - 200 Optimax XS 2.5L / 3.0L		00-04	1,00	PZFR5F-11	4363	-	-
200 hp - 200 Verado 4 cyl. 4 temps	4	-	0,80	ILFR6G-E	4212	-	-
200 hp - 200 Verado 6 cyl. 4 temps	6	04-	0,80	ILFR6G-E	4212	-	-
200 hp - 200 XRi		89-02	-	BUZ8H	7447	-	-

Modèle	Cyl.	0201			N° STOCK	IX	
						N° STOCK IX	N° STOCK IX
200 hp - 2000		78-	-	BUHW	2622	-	-
220 hp - V-220 Laser		87-88	-	BUZ8H	7447	-	-
225 hp		94-97	1,00	BPZ8H-N-10	4495	-	-
225 hp - 3.0L DFI		97-	1,00	PZFR5F-11	4363	-	-
225 hp - 3.0L Sea Pro 6 cyl. 2 temps	6	97-02	0,90	BR8HS	4322	BR8HIX	7001
225 hp - 3.0L Work		94-97	1,00	BPZ8H-N-10	4495	-	-
225 hp - 3.0L Work		98-	0,90	BR8HS	4322	BR8HIX	7001
225 hp - 6 cyl. 2 temps	6	98-01	0,90	BR8HS	4322	BR8HIX	7001
225 hp - 225		80-81	-	BU8H	6431	-	-
225 hp - 225 EFI - 6-cyl. 4 temps, Supercharged	6	06-	0,80	ILFR6G-E	4212	-	-
225 hp - 225 EFI DFI 6 cyl. 2 temps	6	95-06	0,90	BR8HS	4322	BR8HIX	7001
225 hp - 225 EFI DFI 6 cyl. 4 temps	6	06-	1,10	LFR5A-11	6376	LFR5AIX-11	4469
225 hp - 225 Optimax 6 cyl. 2 temps	6	96-04	1,00	PZFR5F-11	4363	-	-
225 hp - 225 Optimax 6 cyl. 2 temps	6	06-	0,80	IZFR5G	5887	-	-
225 hp - 225 Optimax Pro XS 3.0L V6	6	05-11	0,80	IZFR5G	5887	-	-
225 hp - 225 Optimax XS 6 cyl. 2 temps	6	03-04	0,80	IZFR6J	4462	-	-
225 hp - 225 XRi EFI		95-02	0,90	BR8HS	4322	BR8HIX	7001
225 hp - 225 Verado - 6-cyl. 4 temps	6	04-	0,80	ILFR6G-E	4212	-	-
245 hp - 2.5L		95-96	-	BU8H	6431	-	-
250 hp - 250 3.4L		89-90	-	BU8H	6431	-	-
250 hp - 250 EFI - 6 cyl. 4 temps, Supercharged	6	06-	0,80	ILFR6G-E	4212	-	-
250 hp - 250 Verado - 6 cyl. 4 temps	6	04-	0,80	ILFR6G-E	4212	-	-
250 hp - 250 XRi EFI 6 cyl. 2 temps	6	95-06	0,90	BR8HS	4322	BR8HIX	7001
250 hp - 250 XS Optimax 6 cyl. 2 temps	6	03-06	0,80	IZFR6J	4462	-	-
260 hp - 2.5L Offshore		95-97	-	BU8H	6431	-	-
265 hp - 2.5L SS Drag EFI		97-	-	BU8H	6431	-	-
275 hp - 275		89-94	-	BU8H	6431	-	-
275 hp - 275 EFI - 6 cyl. 4 temps, Supercharged	6	06-	0,80	ILFR6G-E	4212	-	-
275 hp - 275 Verado - 6 cyl. 4 temps	6	04-	0,80	ILFR6G-E	4212	-	-
280 hp - 2.5L EFI Sport, EFI SS, Offshore		02-	0,80	BZ7HS-10	3579	-	-
300 hp - 2.5L S3000 EFI		97-	-	BU8H	6431	-	-
300 hp - 3.4L		84-88	-	BU8H	6431	-	-
300 hp - 300		81-83	-	BU8H	6431	-	-
300 hp - 300 Optimax XS EFI 3.2L	6	06-11	0,80	IZFR5J	5899	-	-
300 hp - 300 Verado	6	-	0,80	ILFR6G-E	4212	-	-
300 hp - 300 Verado Pro Four Stroke - 2.6L	6	08-11	1,10	-	-	LFR5AIX-11	4469
350 hp - 350 Verado	6	-	0,80	ILFR6G-E	4212	-	-

MIGHTY MITE

1.7 / 2.0 hp	-	0,60	B-2	3110	-	-
--------------	---	------	-----	------	---	---

MONO

M-5A, M-6A, M-50	-	0,80	B6S	3510	-	-
M-75	-	0,80	BP5S	3011	-	-

MOSKVA

Moskva-25	-	0,80	BP6HS	4511	BPR6HIX	4085
Moskva-30D	-	0,80	BP6ES	7811	BPR6EIX	6637

NAUTILO

3 hp - 75 / 5 hp - 100	-	0,50	B6HS	4510	BR6HIX	3419
------------------------	---	------	------	------	--------	------

NEPTUNE

1A39 / 4A39 / 5A39 / 9A39 / 10A1 / 10A6 / 10A10	-	0,60	B6S	3510	-	-
10A16 / 11A12 / 11A16 / 16A39	-	0,60	AB-6	2910	-	-
11A1 / 15A1 / 111	-	0,60	B-4	3210	-	-
11A10 / 11A3 / 11A6 / 11AA3 / 11AA6	-	0,60	B6S	3510	-	-
15A3 / 15A6 / 15A9 / 15AA3 / 15AA6 / 15AA9	-	0,60	B6S	3510	-	-
17A1 / 17A2 / 17A3 / 17AA1 / 17AA1A	-	0,60	B6S	3510	-	-
101 / 104 / 106 / 113 / 114 / 116 / 139 / 189 / 539	-	0,60	B6S	3510	-	-
238 / 239 / 438 / 439 / 639 / 1016 / 1638 / 1639	-	0,60	AB-6	2910	-	-
938 / 939 / 1010 / 1110	-	0,60	B6S	3510	-	-
A2 / AA2 / AA4 / AA6 / AA10	-	0,60	B6S	3510	-	-
OB 1 / 2 / 2C / 3 / 4 / 11 / 12 / 31 / 32	-	0,60	AB-6	2910	-	-
OB 34 / 51 / 63 / 64 / 65 / 102 / 112	-	0,60	AB-6	2910	-	-

NISSAN

2.0 hp - NSF 2.0A 4 temps	07-	0,60	DCPR6E	3481	DCPR6EIX	8196
2.5 hp - NS 2.5A	85-96	1,00	BP6HS-10	6326	-	-
2.5 hp - NS 2.5A	97-07	1,00	BPR6HS-10	2633	-	-
2.5 hp - NS 2.5A2	-	1,00	BP6HS-10	6326	-	-



Modèle

Cyl.





N° STOCK



N° STOCK IX

2.5 hp - NSF 2.5B 4 temps	-	0,60	DCPR6E	3481	DCPR6EIX	8196
3.5 hp - NS 3.5A	85-92	1,00	BP6HS-10	6326	-	-
3.5 hp - NS 3.5A	97-06	1,00	BPR6HS-10	2633	-	-
3.5 hp - NS 3.5A2	07-	1,00	BPR6HS-10	2633	-	-
3.5 hp - NS 3.5B	93-96	1,00	BP6HS-10	6326	-	-
3.5 hp - NS 3.5B	97-07	1,00	BPR6HS-10	2633	-	-
3.5 hp - NS 3.5B2	-	1,00	BPR6HS-10	2633	-	-
3.5 hp - NSF 3.5A / 4 temps	07-	0,60	DCPR6E	3481	DCPR6EIX	8196
3.5 hp - NSF 3.5B 4 temps	-	0,60	DCPR6E	3481	DCPR6EIX	8196
4.0 hp - NSF 4 / 4 temps	07-08	0,60	DCPR6E	3481	DCPR6EIX	8196
4.0 hp - NSF 4A / 4 temps	00-08	0,60	DCPR6E	3481	DCPR6EIX	8196
4.0 hp - NSF 4A2 / 4B - 4 temps	-	0,60	DCPR6E	3481	DCPR6EIX	8196
5.0 hp - NS 5	85-96	1,00	BP7HS-10	7829	-	-
5.0 hp - NS 5B / 2 temps	97-08	1,00	BPR7HS-10	1092	-	-
5.0 hp - NS 5BS / 2 temps	-	1,00	BPR7HS-10	1092	-	-
5.0 hp - NSF 5 / 4 temps	07-08	0,60	DCPR6E	3481	DCPR6EIX	8196
5.0 hp - NSF 5A / 4 temps	99-08	0,60	DCPR6E	3481	DCPR6EIX	8196
5.0 hp - NSF 5A2 / 5B / 5C / 4 temps	-	0,60	DCPR6E	3481	DCPR6EIX	8196
6.0 hp - NSF 6 / 4 temps	07-08	0,60	DCPR6E	3481	DCPR6EIX	8196
6.0 hp - NSF 6A / 4 temps	04-07	0,60	DCPR6E	3481	DCPR6EIX	8196
6.0 hp - NSF 6A2 / 6B / 6C / 4 temps	-	0,60	DCPR6E	3481	DCPR6EIX	8196
8.0 hp - NS 8A	85-86	1,00	BP7HS-10	7829	-	-
8.0 hp - NS 8B / 2 temps	87-96	1,00	BP7HS-10	7829	-	-
8.0 hp - NS 8B / 2 temps	97-07	1,00	BPR7HS-10	1092	-	-
8.0 hp - NSF 8A / 4 temps	04-08	1,00	DCPR6E	3481	DCPR6EIX	8196
8.0 hp - NSF 8A3 / 4 temps	-	1,00	DCPR6E	3481	DCPR6EIX	8196
9.8 hp - NS 9.8B / 2 temps	98-08	1,00	BPR7HS-10	1092	-	-
9.8 hp - NSF 9.8A / 4 temps	07-	0,60	DCPR6E	3481	DCPR6EIX	8196
9.8 hp - NSF 9.8A3 / 4 temps	-	0,60	DCPR6E	3481	DCPR6EIX	8196
9.9 hp - NS 9.9B	85-96	1,00	B7HS-10	2129	-	-
9.9 hp - NS 9.9B	97-07	1,00	BR7HS-10	1098	-	-
9.9 hp - NS 9.9C / 2 temps	04-08	1,00	B7HS-10	2129	-	-
9.9 hp - NS 9.9D	04-07	1,00	B7HS-10	2129	-	-
9.9 hp - NS 9.9D2 / 2 temps	-	1,00	BP7HS-10	7829	-	-
9.9 hp - NSF 9.9A / 4 temps	00-08	0,60	DCPR6E	3481	DCPR6EIX	8196
9.9 hp - NSF 9.9B / 4 temps	04-08	0,60	DCPR6E	3481	DCPR6EIX	8196
9.9 hp - NSF 9.9B2 / 4 temps	-	0,60	DCPR6E	3481	DCPR6EIX	8196
12 hp - NS 12	85-87	1,00	B7HS-10	2129	-	-
12 hp - NS 12	94-	1,00	B7HS-10	2129	-	-
12 hp - NS 12C	04-07	1,00	BR7HS-10	1098	-	-
15 hp - NS 15B	85-92	1,00	B7HS-10	2129	-	-
15 hp - NS 15B / 15D	04-07	1,00	BR7HS-10	1098	-	-
15 hp - NS 15C	93-96	1,00	BP7HS-10	7829	-	-
15 hp - NS 15C	97-99	1,00	BPR7HS-10	1092	-	-
15 hp - NS 15C / 2 temps	04-07	1,00	B7HS-10	2129	-	-
15 hp - NS 15D	00-01	0,80	BPR7HS-10	1092	-	-
15 hp - NS 15D / 2 temps	-	1,00	B7HS-10	2129	-	-
15 hp - NSF 15A / 15B / 4 temps	04-08	0,60	DCPR6E	3481	DCPR6EIX	8196
15 hp - NSF 15B2 / 15C / 4 temps	-	0,60	DCPR6E	3481	DCPR6EIX	8196
18 hp - NS 18	93-96	1,00	B7HS-10	2129	-	-
18 hp - NS 18	97-99	1,00	BR7HS-10	1098	-	-
18 hp - NS 18C	85-92	1,00	B7HS-10	2129	-	-
18 hp - NS 18C	04-07	1,00	B7HS-10	2129	-	-
18 hp - NS 18D / 2 temps	04-08	1,00	B7HS-10	2129	-	-
18 hp - NS 18E	00-01	0,80	BPR7HS-10	1092	-	-
18 hp - NS 18E	04-07	1,00	BR7HS-10	1098	-	-
18 hp - NS 18E2	-	1,00	B7HS-10	2129	-	-
18 hp - NSF 18B / 18B2 / 4 temps	04-08	0,60	DCPR6E	3481	DCPR6EIX	8196
20 hp - NS F20C / 4 temps	-	0,60	DCPR6E	3481	DCPR6EIX	8196
25 hp - NS 25	86-96	1,00	B7HS-10	2129	-	-
25 hp - NS 25C	97-07	0,80	BR7HS-10	1098	-	-
25 hp - NS 25C3	-	1,00	B7HS-10	2129	-	-
25 hp - NSF 25A / 4 temps	04-08	0,60	DCPR6E	3481	DCPR6EIX	8196
25 hp - NSF 25B / 4 temps	07-08	0,60	DCPR6E	3481	DCPR6EIX	8196
30 hp - NS 30A	86-96	1,00	B7HS-10	2129	-	-
30 hp - NS 30A	97-07	1,00	BR7HS-10	1098	-	-
30 hp - NS 30A4	-	1,00	B7HS-10	2129	-	-
30 hp - NSF 30A / 4 temps	04-08	0,60	DCPR6E	3481	DCPR6EIX	8196
30 hp - NSF 30B / 4 temps	07-08	0,60	DCPR6E	3481	DCPR6EIX	8196
35 hp - NS 35C	94-95	1,00	B7HS-10	2129	-	-
40 hp - NS 40C	2 85-92	1,00	B7HS-10	2129	-	-
40 hp - NS 40C	04-07	1,00	BR7HS-10	1098	-	-
40 hp - NS 40D	3 91-96	1,00	B7HS-10	2129	-	-
40 hp - NS 40D	97-06	0,80	BR7HS-10	1098	-	-
40 hp - NS 40D / 2 temps	07-08	1,00	B7HS-10	2129	-	-

Modèle	Cyl.	0201			N° STOCK	NISSAN	
							N° STOCK IX
40 hp - NS 40D2	3	-	1,00	B7HS-10	2129	-	-
40 hp - NS 40D2		07-	0,80	BR7HS-10	1098	-	-
40 hp - NSD 40A TLDI		04-08	1,10	ZFR6F-11	4291	ZFR6FIX-11	6441
40 hp - NSD 40B TLDI		04-08	0,80	PZFR6H	7696	-	-
40 hp - NSD 40B2 TLDI		-	0,80	IZFR6Q	91234	-	-
45 hp - NS 45A		94-95	1,00	B8HS-10	5126	-	-
50 hp - NS 50C / 2 temps	2	85-92	1,00	B8HS-10	5126	-	-
50 hp - NS 50D / 2 temps	3	91-96	1,00	B8HS-10	5126	-	-
50 hp - NS 50D		97-06	1,00	BR8HS-10	1134	-	-
50 hp - NS 50D / 2 temps		07-08	1,00	B8HS-10	5126	-	-
50 hp - NS 50D2		07-	1,00	BR8HS-10	1134	-	-
50 hp - NSD 50A TLDI		04-08	1,10	ZFR6F-11	4291	ZFR6FIX-11	6441
50 hp - NSD 50B TLDI		04-08	0,80	PZFR6H	7696	-	-
50 hp - NSD 50B2 TLDI		-	0,80	IZFR6Q	91234	-	-
50 hp - W50B TLDI		04-08	0,80	PZFR6H	7696	-	-
60 hp - NS 55		85-86	1,00	B8HS-10	5126	-	-
60 hp - NS 60A / 2 temps	2	87-92	1,00	B8HS-10	5126	-	-
60 hp - NS 60B		93-95	1,00	B8HS-10	5126	-	-
60 hp - NS 60B / 2 temps	3	04-07	1,00	B8HS-10	5126	-	-
60 hp - NS 60C / 2 temps	3	04-07	1,00	BR8HS-10	1134	-	-
70 hp - NS 70A / 2 temps	2	-	1,00	B8HS-10	5126	-	-
70 hp - NS 70B / 2 temps	3	86-96	1,00	B8HS-10	5126	-	-
70 hp - NS 70B		97-99	1,00	BR8HS-10	1134	-	-
70 hp - NS 70B / 2 temps	3	04-07	1,00	B8HS-10	5126	-	-
70 hp - NS 70C		00-07	1,00	BR8HS-10	1134	-	-
70 hp - NSD 70A TLDI		04-08	1,10	ZFR6F-11	4291	ZFR6FIX-11	6441
70 hp - NSD 70A2 TLDI		-	1,10	ZFR6F-11	4291	ZFR6FIX-11	6441
70 hp - NSD 70B TLDI		04-06	0,80	PZFR6H	7696	-	-
70 hp - NSD 70B TLDI		07-	1,10	PZFR6F-11	3271	-	-
75 hp - NSD 75C2 TLDI		-	0,80	IZFR6Q	91234	-	-
90 hp - NS 90A		87-96	1,00	B8HS-10	5126	-	-
90 hp - NS 90A		97-07	1,00	BR8HS-10	1134	-	-
90 hp - NSD 90A TLDI		04-07	1,10	ZFR6F-11	4291	ZFR6FIX-11	6441
90 hp - NSD 90A2 TLDI		-	1,10	ZFR6F-11	4291	ZFR6FIX-11	6441
90 hp - NSD 90B TLDI		04-06	0,80	PZFR6H	7696	-	-
90 hp - NSD 90B TLDI		07-	1,10	PZFR6F-11	3271	-	-
90 hp - NSD90C2		-	0,80	IZFR6Q	91234	-	-
115 hp - NSD 115A TLDI		07-08	0,80	IZFR5J	5899	-	-
115 hp - NSD 115A2 TLDI		-	0,80	IZFR5J	5899	-	-
120 hp - NS 120A		90-96	1,00	B8HS-10	5126	-	-
120 hp - NS 120A		97-07	1,00	BR8HS-10	1134	-	-
140 hp - NS 140A		90-96	1,00	B8HS-10	5126	-	-
140 hp - NS 140A2		97-06	1,00	BR8HS-10	1134	-	-

PARSUN

2 temps - 2.5 / 3.6 / 9.9 / 15 / 30 / 40 hp	-	0,70	BPR7HS	6422	BPR7HIX	5944
4 Temps - 2.6 / 4.0 / 5.0 hp	-	0,70	BPR7HS	6422	BPR7HIX	5944
4 Temps - 15 / 25 hp	-	0,70	DPR7EA-9	5129	-	-





PERKINS

4.5 / 6.5 hp (18mm)	62-65	0,70	B6S	3510	-	-
6.0 hp (18mm)	59-61	0,70	B6S	3510	-	-
16 hp (18mm)	59-61	0,70	B-6L	3212	-	-
18 hp (18mm)	62-65	0,70	B-6L	3212	-	-
30 hp (18mm)	62-65	0,90	B6HS	4510	BR6HIX	3419
35 hp (14mm)	61-	0,90	B6HS	4510	BR6HIX	3419
35 hp (18mm)	59-60	0,90	AB-6	2910	-	-
40 hp (18mm)	59-65	0,90	B6HS	4510	BR6HIX	3419

SEA KING (Wards)

9.2 cu in.	76-	0,80	B8HS	5510	BR8HIX	7001
9.2 cu in.	79-80	0,60	XR5	3332	XR5IX	7355
2.0 hp	79-80	0,60	B-2	3110	-	-
3.5 / 5.8 hp	64-70	0,80	B-6L	3212	-	-
3.5 hp	79-80	0,60	BM6A	5921	-	-
4.0 / 7.5 hp	79-86	0,80	B6HS	4510	BR6HIX	3419
5.0 hp	69-	0,90	B6S	3510	-	-
5.9 hp	79-80	0,60	XR5	3332	XR5IX	7355
6.0 hp	67-71	0,80	B-6L	3212	-	-
6.0 hp	72-76	0,80	B8HS	5510	BR8HIX	7001
7.0 hp	69-	0,90	XR5	3332	XR5IX	7355
9.6 hp	68-74	0,80	B8HS	5510	BR8HIX	7001
9.9 hp	80-86	0,80	B7HS	5110	BR7HIX	7067

SEA KING (Wards)





 Modèle	Cyl.				N° STOCK		N° STOCK IX
10 / 15 / 25 hp		74-76	0,80	B8HS	5510	BR8HIX	7001
15 hp		78-86	0,80	B7HS	5110	BR7HIX	7067
20 hp		68-74	0,80	B8HS	5510	BR8HIX	7001
35 hp		68-75	0,80	B8HS	5510	BR8HIX	7001
35 hp		78-79	0,80	B8HS	5510	BR8HIX	7001
55 hp		68-75	0,80	B8HS	5510	BR8HIX	7001

SEARS

1.2 hp - 585120 / 585121	-	0,60	BR6S	3522	-	-
1.2 hp - 585122	-	0,60	BMR6A	7421	-	-
2.0 hp - 58241 / 58250	-	0,80	B-4	3210	-	-
3.0 hp - 58540 / 58541 / 58543 / 58544	-	0,80	XR5	3332	XR5IX	7355
3.0 hp - 58210 / 585211 / 58220	-	0,80	XR5	3332	XR5IX	7355
3.5 hp - 6003 / 60020 / 60030	-	0,80	B-6L	3212	-	-
3.5 hp - 6091 / 6094 / 59501 / 59900	-	0,80	BM6A	5921	-	-
3.5 hp - 58510 / 59860 / 59861	-	0,90	B6S	3510	-	-
3.5 hp - 58542 / 58550 / 58560 / 59862	-	0,90	XR5	3332	XR5IX	7355
3.5 hp - 585230 / 585240 / 585241 / 585280	-	0,80	XR5	3332	XR5IX	7355
3.6 hp - 6001 / 60000	-	0,80	B-6L	3212	-	-
3.6 hp - 58511 / 58512	-	0,90	B6S	3510	-	-
3.6 hp - 58513 / 58514	-	0,90	XR5	3332	XR5IX	7355
4.0 hp - 58580 / 585270	-	0,80	XR5	3332	XR5IX	7355
4.5 hp - 59460 / 59461 / 59162 / 59463 / 59464	-	0,90	XR5	3332	XR5IX	7355
4.8 hp - 58970 / 58971	-	0,90	XR5	3332	XR5IX	7355
5.0 hp - 58520 / 58960 / 58961	-	0,90	B6S	3510	-	-
5.0 hp - 58521 / 58610 / 58620 / 58962 / 58990	-	0,90	XR5	3332	XR5IX	7355
5.0 hp - 58991 / 58992 / 59310	-	0,90	XR5	3332	XR5IX	7355
5.0 hp - 59520 / 59670 / 59671 / 59672	-	0,90	B6S	3510	-	-
5.0 hp - 585420 / 585430 / 585441 / 585460 / 585470	-	0,80	XR5	3332	XR5IX	7355
5.0 hp - 59311 / 59673 / 59680 / 585411 / 595410	-	0,90	XR5	3332	XR5IX	7355
5.0 hp - 595431 / 595440	-	0,80	XR5	3332	XR5IX	7355
5.5 hp - 59430 / 59431 / 59432 / 59433 / 59980 / 585710	-	0,90	XR5	3332	XR5IX	7355
6.0 hp - 6004 / 6005 / 60060	-	0,80	B-6L	3212	-	-
7.0 hp - 58530 / 58531 / 58532 / 58830	-	0,90	XR5	3332	XR5IX	7355
7.0 hp - 59440 / 59840 / 59970	-	0,90	XR5	3332	XR5IX	7355
7.0 hp - 585860 / 585861	-	0,80	XR5	3332	XR5IX	7355
7.5 hp - 6008 / 6012 / 6012 / 60070 / 60090 / 60100	-	0,80	B-6L	3212	-	-
7.5 hp - 58809 / 58820 / 58821 / 58550 / 58880	-	0,90	XR5	3332	XR5IX	7355
7.5 hp - 58881 / 58882 / 58891 / 59450 / 59490 / 59491	-	0,90	XR5	3332	XR5IX	7355
7.5 hp - 585780 / 585821 / 585830 / 585880 / 585910	-	0,90	XR5	3332	XR5IX	7355
7.5 hp - 585810 / 585811 / 585840	-	0,80	XR5	3332	XR5IX	7355
7.5 hp - 585911 / 585931 / 586110 / 586111 / 586120	-	0,90	XR5	3332	XR5IX	7355
7.5 hp - 585850 / 585890 / 585920 / 585930	-	0,80	XR5	3332	XR5IX	7355
9.9 hp - 58710 / 58711 / 586210 / 586211	-	0,80	XR5	3332	XR5IX	7355
9.9 hp - 586220 / 586230 / 586231 / 586240	-	0,80	XR5	3332	XR5IX	7355
10.5 hp - 58720 / 58721	-	0,80	XR5	3332	XR5IX	7355
12 hp - 5927	-	0,80	B-6L	3212	-	-
14 hp - 6013 / 6014 / 6015	-	0,80	B6S	3510	-	-
15 hp - 58105	-	0,80	B7HS	5110	BR7HIX	7067
15 hp - 58760 / 58761 / 586310 / 586311	-	0,80	XR5	3332	XR5IX	7355
15 hp - 586320 / 586330 / 586331 / 586340	-	0,80	XR5	3332	XR5IX	7355
25 hp	-	0,80	B8HS	5510	BR8HIX	7001
27.7 hp - 6033 / 6035	-	0,80	B6S	3510	-	-
28 hp - 6037 / 6038	-	0,80	B6S	3510	-	-
28 hp - 60340 / 60360 / 60370 / 60380	-	0,80	B8S	3810	-	-
35 hp - 5941	-	0,80	B8S	3810	-	-
43.7 hp - 6045 / 6050 / 60541 / 60644	-	0,80	B6S	3510	-	-
45 hp - 5056 / 5057 / 5058 / 60540 / 60550	-	0,80	B8S	3810	-	-
75 hp - 6078 / 60740 / 60750	-	0,80	B8S	3810	-	-
75.2 hp - 6070 / 6071	-	0,80	B6S	3510	-	-
75.2 hp - 6076 / 6077	-	0,80	B8S	3810	-	-

SELVA

S 85 / 95 / 95SC / 110 / 115 / 115SC / 120 / 125	-	0,50	BP6HS	4511	BPR6HIX	4085
S 130 / 135 / 135SC / 155 / 165 / 170 / 175	-	0,50	BP6HS	4511	BPR6HIX	4085
S 250 / 260 / 350 / 495XS / 525	-	0,50	BP6HS	4511	BPR6HIX	4085
S 400 / 405 / 490 / 495 / 505	-	0,50	BP7HS	5111	BPR7HIX	5944
S500	-	0,50	B6HS	4510	BR6HIX	3419
S600 Master, S650 (40HP)	-	0,50	B8HS	5510	BR8HIX	7001
S650	89-	0,50	B8HS	5510	BR8HIX	7001
S650 (50HP) / S700 / S750 / S800 / S850	-	0,50	B8HS	5510	BR8HIX	7001
S800 Best, S1000 / S1350 / S1400	-	0,50	B8HS	5510	BR8HIX	7001
2.4 hp - Elba 56cc	-	0,50	BPMR6A	6726	-	-
2.5 hp - S60 SI	-	0,50	BPM6A	7021	-	-

 Modèle	Cyl.				N° STOCK		N° STOCK IX
3.0 / 4.5 hp	-	-	0,50	B6S	3510	-	-
4 hp	-	-	0,50	BP6HS	4511	BPR6HIX	4085
5 hp - Capri 125cc	-	-	0,80	BPR6HS	7022	BPR6HIX	4085
5 hp - S115 / S115 Sl	-	-	0,50	BPR6HS	7022	BPR6HIX	4085
6 hp	-	-	0,50	BP6HS	4511	BPR6HIX	4085
8 hp - Izmir 170cc	-	-	0,80	BPR6HS	7022	BPR6HIX	4085
8 hp - S165	-	-	0,50	BPR6HS	7022	BPR6HIX	4085
9.9 / 15 hp	-	-	0,50	BP6HS	4511	BPR6HIX	4085
20 hp	-	-	0,50	BP7HS	5111	BPR7HIX	5944
20 hp - Rhodes 398cc	-	-	0,80	BPR6HS	7022	BPR6HIX	4085
20 hp - S405	-	-	0,50	BPR6HS	7022	BPR6HIX	4085
25 hp - Antibes / Majorca 489cc	-	-	0,80	BPR6HS	7022	BPR6HIX	4085
25 hp - Master	89-	-	0,50	B8HS	5510	BR8HIX	7001
25 hp - S495	-	-	0,50	BPR6HS	7022	BPR6HIX	4085
25 hp - S500 Grand Prix / S600 Master	-	-	1,00	B7HS-10	2129	-	-
25 hp - S800 Best / S1050 Super Best	-	-	1,00	B7HS-10	2129	-	-
25 hp - XS (495CC, 2carb.)	88-	-	0,50	BP6HS	4511	BPR6HIX	4085
30 hp - S505 Antibes 489cc	-	-	1,00	B7HS-10	2129	-	-
35 hp - S525 Majorca 489cc	-	-	1,00	B7HS-10	2129	-	-
35 hp - autres modèles	-	-	0,50	B8HS	5510	BR8HIX	7001
40 hp - S625 Madeira 684cc	-	-	1,00	B7HS-10	2129	-	-
40 hp - Saint Tropez 741cc	-	-	1,00	B7HS-10	2129	-	-
50 hp - S700 Madeira 684cc	2	-	1,00	B7HS-10	2129	-	-
50 hp - autres modèles	-	-	0,50	B8HS	5510	BR8HIX	7001
55 hp - S750	-	-	1,00	B7HS-10	2129	-	-
60 hp - Saint Tropez 831cc	3	-	1,00	B7HS-10	2129	-	-
65 hp - S850	-	-	1,00	B7HS-10	2129	-	-
65 hp - autres modèles	-	-	0,50	B8HS	5510	BR8HIX	7001
70 hp - Tenerife 831cc	-	-	1,00	B7HS-10	2129	-	-
74.5 hp - S1300 Endurance	-	-	1,00	B7HS-10	2129	-	-
75 hp - Montecarlo 1298cc	-	-	1,00	B7HS-10	2129	-	-
80 hp - autres modèles	-	-	0,50	B8HS	5510	BR8HIX	7001
80 hp - S1000 Potosino 1025cc	3	-	1,00	B7HS-10	2129	-	-
90 hp - S1350 Montecarlo 1298cc	-	-	1,00	B7HS-10	2129	-	-
100 hp - S1400 Montecarlo 1368cc	-	-	1,00	B7HS-10	2129	-	-

SELVA GEMINI

3 / 4.5 / 6 PS	-	-	0,50	B6S	3510	-	-
----------------	---	---	------	-----	------	---	---

SOLO





2.5 / 4 PS	-	-	0,50	B6HS	4510	BR6HIX	3419
55 / 70 PS	-	-	0,90	B9HS	5810	BR9HIX	5687





SPIRIT (Suzuki)

2.0 hp	77-81	-	0,60	BR5HS	3722	-	-
3.5 / 5.0 hp	79-81	-	0,80	BPR6HS	7022	BPR6HIX	4085
4.5 hp	76-77	-	0,70	BR6HS	3922	BR6HIX	3419
7.5 hp	-	-	0,70	BR6HS	3922	BR6HIX	3419
8.0 hp	80-81	-	0,70	BPR6HS	7022	BPR6HIX	4085
9.0 hp	76-81	-	0,70	BR6HS	3922	BR6HIX	3419
9.9 hp	76-80	-	0,70	BR6HS	3922	BR6HIX	3419
16 / 20 / 25 hp	76-81	-	0,70	BR7HS	4122	BR7HIX	7067
40 hp	80-81	-	0,90	BR8HS	4322	BR8HIX	7001
50 / 65 hp	77-81	-	0,90	BR8HS	4322	BR8HIX	7001
85 hp	79-81	-	0,90	BR8HS	4322	BR8HIX	7001





SUZUKI

2.0 hp - DT2	77-89	-	0,70	B-4H	4110	-	-
2.0 hp - DT2	90-97	-	0,70	BR5HS	3722	-	-
2.2 hp - DT2.2	86-92	-	0,70	B-4H	4110	-	-
2.2 hp - DT2.2	1	93-97	0,70	BR5HS	3722	-	-
2.5 hp - DF2.5	1	06-11	0,70	CR6HSA	2983	CR6HIX	7274
3.5 hp - DT3.5	1	77-84	0,70	BP6HS	4511	BPR6HIX	4085
4.0 hp - DF4	1	03-10	0,80	BPR6ES	7822	BPR6EIX	6637
4.0 hp - DF4	1	11-	0,90	CPR6EA-9	6899	-	-
4.0 hp - DT4	1	85-87	0,70	BP6HS	4511	BPR6HIX	4085
4.0 hp - DT4	1	88-98	0,70	BPR5HS	6222	-	-
4.0 hp - DT4D, 4.5 hp - DT4.5	1	77-79	0,70	B6HS	4510	BR6HIX	3419
5.0 hp - DF5 4 temps	1	02-	0,80	BPR6ES	7822	BPR6EIX	6637
5.0 hp - DT5	-	99-00	0,70	BPR5HS	6222	-	-
5.0 hp - DT5 - 2 cyl.	2	77-83	0,60	BP6HS	4511	BPR6HIX	4085
5.0 hp - DT5W	-	86-92	0,70	BR6HS	3922	BR6HIX	3419
5.0 hp - DT5Y - 1 cyl.	1	99-02	1,00	BPR7HS-10	1092	-	-

 Modèle	Cyl.				N° STOCK		N° STOCK IX
6.0 hp - DF6	1	03-10	0,80	BPR6ES	7822	BPR6EIX	6637
6.0 hp - DF6	1	11-	0,90	CPR6EA-9	6899	-	-
6.0 hp - DT6 - 2 cyl.	2	84-85	0,90	BP6HS	4511	BPR6HIX	4085
6.0 hp - DT6 - 2 cyl.	2	86-92	1,00	B6HS-10	1052	-	-
6.0 hp - DT6 - 2 cyl.	2	93-02	1,00	BR6HS-10	1090	-	-
7.5 hp - DT7.5 - 2 cyl.	2	77-79	0,70	B6HS	4510	BR6HIX	3419
8.0 hp - DF8A	2	10-11	0,80	CR6E	6965	-	-
8.0 hp - DF8AR		10-	0,80	CR6E	6965	-	-
8.0 hp - DT8 - 2 cyl.	2	77-87	0,90	BP6HS	4511	BPR6HIX	4085
8.0 hp - DT8C - 2 cyl.	2	88-92	1,00	B6HS-10	1052	-	-
8.0 hp - DT8C - 2 cyl.	2	93-97	1,00	BR6HS-10	1090	-	-
9.0 hp - DT9 - 2 cyl.	2	77-79	0,70	B6HS	4510	BR6HIX	3419
9.9 hp - DF9.9 - 2 cyl. 4 temps	2	96-04	0,90	DCPR6E	3481	DCPR6EIX	8196
9.9 hp - DF9.9 - 2 cyl. 4 temps	2	05-10	0,80	-	-	BKR6EIX	6418
9.9 hp - DF9.9 - 2 cyl. 4 temps	2	11-	0,90	CPR6EA-9	6899	-	-
9.9 hp - DF9.9A - 2 cyl. 4 temps	2	10-11	0,80	CR6E	6965	-	-
9.9 hp - DT9.9 - 2 cyl.	2	77-82	1,00	BR7HS-10	1098	-	-
9.9 hp - DT9.9 - 2 cyl.	2	83-85	1,00	B7HS-10	2129	-	-
9.9 hp - DT9.9 - 2 cyl.	2	86-88	1,00	B6HS-10	1052	-	-
9.9 hp - DT9.9C - 2 cyl.	2	88-91	0,70	B6HS	4510	BR6HIX	3419
9.9 hp - DT9.9C - 2 cyl.	2	92-	1,00	B6HS-10	1052	-	-
9.9 hp - DT9.9C - 2 cyl.	2	93-97	1,00	BR6HS-10	1090	-	-
9.9 hp - DT9.9E		84-	0,70	B7HS	5110	BR7HIX	7067
9.9 hp - DT9.9K		-	1,00	BR6HS-10	1090	-	-
9.9 hp - DT9.9P		-83	0,70	B6HS	4510	BR6HIX	3419
15 hp - DF15 - 2 cyl. 4 temps	2	96-04	0,90	DCPR6E	3481	DCPR6EIX	8196
15 hp - DF15 - 2 cyl. 4 temps	2	05-10	0,80	-	-	BKR6EIX	6418
15 hp - DF15 - 2 cyl. 4 temps	2	11-	0,90	CPR6EA-9	6899	-	-
15 hp - DT15 - 2 cyl.	2	83-88	0,70	B7HS	5110	BR7HIX	7067
15 hp - DT15C - 2 cyl.	2	89-91	1,00	B7HS-10	2129	-	-
15 hp - DT15C - 2 cyl.	2	92-97	1,00	BR7HS-10	1098	-	-
15 hp - DT15K		-85	0,70	BR6HS	3922	BR6HIX	3419
15 hp - DT15K		-86-	0,70	B6HS	4510	BR6HIX	3419
16 hp - DT16 - 2 cyl.	2	77-82	0,70	B7HS	5110	BR7HIX	7067
16 hp - DT16P		-	0,70	B7HS	5110	BR7HIX	7067
20 hp - DT20		95-96	1,00	BR7HS-10	1098	-	-
20 hp - DT20 - 2 cyl.	2	77-88	0,70	B7HS	5110	BR7HIX	7067
20 hp - DT20K		-85	1,00	BR7HS-10	1098	-	-
20 hp - DT20K		86-87	1,00	B7HS-10	2129	-	-
20 hp - DT20P		-85	0,70	B7HS	5110	BR7HIX	7067
25 hp - DF25		10-	0,70	CR6HSA	2983	CR6HIX	7274
25 hp - DF25 - 3 cyl. 4 temps	3	00-06	0,90	DCPR6E	3481	DCPR6EIX	8196
25 hp - DF25 - V-Twin	2	06-11	0,80	-	-	BKR6EIX	6418
25 hp - DT25 - 3 cyl.	3	77-88	1,00	B7HS-10	2129	-	-
25 hp - DT25 - 3 cyl.	3	98-	1,00	BR7HS-10	1098	-	-
25 hp - DT25C - 3 cyl.	3	89-92	1,00	B7HS-10	2129	-	-
25 hp - DT25C - 3 cyl.	3	93-00	1,00	BR7HS-10	1098	-	-
25 hp - DT25E		-82	0,70	B7HS	5110	BR7HIX	7067
25 hp - DT25E		83-85	1,00	BPR7HS-10	1092	-	-
25 hp - DT25E		-86-	1,00	BR7HS-10	1098	-	-
25 hp - DT25K		-97	1,00	B7HS-10	2129	-	-
25 hp - DT25K		-98-	0,70	B7HS	5110	BR7HIX	7067
25 hp - DT25P		-	0,70	B7HS	5110	BR7HIX	7067
28 hp - DT28 / DT28E / DT28P		-83	0,70	B7HS	5110	BR7HIX	7067
30 hp - DF30 - 3 cyl. 4 temps	3	00-07	0,90	DCPR6E	3481	DCPR6EIX	8196
30 hp - DT30 - 1 cyl.	1	83-85	1,00	B7HS-10	2129	-	-
30 hp - DT30 - 2 cyl.	2	86-87	1,00	B7HS-10	2129	-	-
30 hp - DT30C - 3 cyl.	3	88-92	1,00	B7HS-10	2129	-	-
30 hp - DT30C - 3 cyl.	3	93-98	1,00	BR7HS-10	1098	-	-
30 hp - DT30E (R)		83-	1,00	BR7HS-10	1098	-	-
35 hp - DT35 - 2 cyl.	2	80-82	0,90	BR8HS	4322	BR8HIX	7001
35 hp - DT35 - 2 cyl.	2	87-89	1,00	B8HS-10	5126	-	-
40 hp - DF40 - 3 cyl. 4 temps	3	99-10	0,90	DCPR6E	3481	DCPR6EIX	8196
40 hp - DF40A - 3 cyl. 4 temps	3	11-	0,90	DCPR6E	3481	DCPR6EIX	8196
40 hp - DT40 - 2 cyl.	2	80-82	0,90	BR8HS	4322	BR8HIX	7001
40 hp - DT40 - 2 cyl.	2	83-85	0,90	B8HS	5510	BR8HIX	7001
40 hp - DT40C - 2 cyl.	2	84-92	0,90	B8HS	5510	BR8HIX	7001
40 hp - DT40C - 2 cyl.	2	93-	0,90	BR8HS	4322	BR8HIX	7001
40 hp - DT40C - 2 cyl.	2	94-98	1,00	BR8HS-10	1134	-	-
40 hp - DT40CR / DT40TC		94-98	1,00	BR8HS-10	1134	-	-
40 hp - DT40K / DT40KR		-	1,00	B7HS-10	2129	-	-
40 hp - DT40W / DT40WK		-97	0,90	B8HS	5510	BR8HIX	7001
40 hp - DT40W / DT40WK		-98-	1,00	B8HS-10	5126	-	-
40 hp - PU40 - 2 cyl.	2	89-92	0,90	B8HS	5510	BR8HIX	7001
40 hp - PU40 - 2 cyl.	2	93-	0,90	BR8HS	4322	BR8HIX	7001

 Modèle	Cyl.				N° STOCK		N° STOCK IX
40 hp - PU40 - 2 cyl.	2	94-95	1,00	BR8HS-10	1134	-	-
46 hp - DF46	3	05-08	0,80	BPR6ES	7822	BPR6EIX	6637
48 hp - DT48M		-00	0,90	B8HS	5510	BR8HIX	7001
48 hp - DT48M		01-	1,00	B8HS-10	5126	-	-
50 hp - DF50 - 3 cyl. 4 temps	3	99-10	0,90	DCPR6E	3481	DCPR6EIX	8196
50 hp - DF50A - 3 cyl. 4 temps	3	11-	0,90	DCPR6E	3481	DCPR6EIX	8196
50 hp - DT50 - 2 cyl.	2	77-90	1,00	B8HS-10	5126	-	-
50 hp - DT50ACR		94-96	1,00	BR8HS-10	1134	-	-
50 hp - DT50C		84-00	1,00	B8HS-10	5126	-	-
50 hp - DT50 C / M / W		01-	1,00	BR8HS-10	1134	-	-
50 hp - DT50K		-	0,90	B7HS	5110	BR7HIX	7067
50 hp - DT50M / DT50T / DT50W		-85	0,90	B8HS	5510	BR8HIX	7001
50 hp - DT50M / DT50W		86-89	0,90	B8HS-10	5126	-	-
55 hp - DT55 - 3 cyl.	3	85-92	0,90	B8HS	5510	BR8HIX	7001
55 hp - DT55 - 3 cyl.	3	93-95	0,80	BR8HS	4322	BR8HIX	7001
55 hp - DT55 - 3 cyl.	3	96-97	1,00	BR8HS-10	1134	-	-
55 hp - DT55 C / CRQ / M / TC		-	1,00	BR8HS-10	1134	-	-
55 hp - PU55 - 3 cyl.	3	89-93	0,90	B8HS	5510	BR8HIX	7001
55 hp - PU55 - 3 cyl.	3	94-95	1,00	BR8HS-10	1134	-	-
60 hp - DF60 - 3 cyl. 4 temps	3	98-09	0,80	BPR6ES	7822	BPR6EIX	6637
60 hp - DF60A - 3 cyl. 4 temps	3	10-11	0,90	DCPR6E	3481	DCPR6EIX	8196
60 hp - DT60 - 3 cyl. 2 temps	3	83-84	0,90	B8HS	5510	BR8HIX	7001
60 hp - DT60C		86-87	1,00	B8HS-10	5126	-	-
60 hp - DT60C		01-	1,00	BR8HS-10	1134	-	-
60 hp - DT60W		-97	0,90	B8HS	5510	BR8HIX	7001
60 hp - DT60W		98-	1,00	B8HS-10	5126	-	-
65 hp - DT65 - 3 cyl.	3	78-83	0,90	B8HS	5510	BR8HIX	7001
65 hp - DT65 - 3 cyl.	3	85-92	0,90	B8HS	5510	BR8HIX	7001
65 hp - DT65 - 3 cyl.	3	93-95	0,80	BR8HS	4322	BR8HIX	7001
65 hp - DT65 - 3 cyl.	3	96-97	1,00	BR8HS-10	1134	-	-
65 hp - DT65C		-92	0,90	B8HS	5510	BR8HIX	7001
65 hp - DT65C		93-	0,90	BR8HS	4322	BR8HIX	7001
65 hp - DT65T		-83	0,90	B8HS	5510	BR8HIX	7001
65 hp - DT65TC		93-98	0,80	BR8HS	4322	BR8HIX	7001
65 hp - DT65TC		98-	1,00	BR8HS-10	1134	-	-
70 hp - DF70 - 4 cyl. 4 temps	4	98-09	0,80	BPR6ES	7822	BPR6EIX	6637
70 hp - DF70A	4	09-11	0,90	DCPR6E	3481	DCPR6EIX	8196
70 hp - DF70THL, TL	3	05-07	0,80	BPR6ES	7822	BPR6EIX	6637
75 hp - DT75 - 3 cyl.	3	83-92	0,80	B8HS	5510	BR8HIX	7001
75 hp - DT75 - 3 cyl.	3	93-96	0,80	BR8HS	4322	BR8HIX	7001
75 hp - DT75 - 3 cyl.	3	96-97	1,00	BR8HS-10	1134	-	-
75 hp - DT75C / DT75M		-00	0,90	BR8HS	4322	BR8HIX	7001
75 hp - DT75 C / M / TC		01-	1,00	BR8HS-10	1134	-	-
75 hp - DT75TC		-00	0,80	B8HS	5510	BR8HIX	7001
80 hp - DF80A	4	09-11	0,90	DCPR6E	3481	DCPR6EIX	8196
85 hp - DT85 - 3 cyl.	3	79-92	0,90	B8HS	5510	BR8HIX	7001
85 hp - DT85 - 3 cyl.	3	93-	0,90	BR8HS	4322	BR8HIX	7001
85 hp - DT85 - 3 cyl.	3	94-00	1,00	BR8HS-10	1134	-	-
85 hp - DT85C		-92	0,90	B8HS	5510	BR8HIX	7001
85 hp - DT85C		93-00	0,90	BR8HS	4322	BR8HIX	7001
85 hp - DT85 C / M / Q / TC / W		01-	1,00	BR8HS-10	1134	-	-
85 hp - DT85 M / Q / TC / W		-00	0,90	BR8HS	4322	BR8HIX	7001
85 hp - DT85MQ		95-96	1,00	B8HS-10	5126	-	-
85 hp - DT85WT		-	1,00	B8HS-10	5126	-	-
85 hp - PU85 - 3 cyl.	3	89-93	0,90	B8HS	5510	BR8HIX	7001
85 hp - PU85 - 3 cyl.	3	94-97	1,00	BR8HS-10	1134	-	-
86 hp - DT86		-00	0,90	B8HS	5510	BR8HIX	7001
86 hp - DT86		01-	1,00	BR8HS-10	1134	-	-
90 hp - DF90 - 4 cyl. 4 temps	4	01-08	0,80	-	-	BKR6EIX	6418
90 hp - DF90A	4	09-11	0,90	DCPR6E	3481	DCPR6EIX	8196
90 hp - DT90 - V4	4	89-90	1,00	BR8HS-10	1134	-	-
90 hp - DT90 - V4	4	91-95	1,00	BR8HCS-10	1157	-	-
90 hp - DT90 - V4	4	96-97	1,00	BR8HS-10	1134	-	-
90 hp - DT90TC		-95	1,00	BR8HCS-10	1157	-	-
90 hp - DT90TC		96-97	0,90	BR8HS	4322	BR8HIX	7001
90 hp - DT90TC		98-	1,00	BR8HS-10	1134	-	-
99 hp - DF99AR	4	10-	0,80	CR6E	6965	-	-
99 hp - DF99TH	4	10-	0,90	DCPR6E	3481	DCPR6EIX	8196
100 hp - DF100 / DF100A	4	09-10	0,80	-	-	BKR6EIX	6418
100 hp - DT100 - V4	4	89-90	1,00	BR8HS-10	1134	-	-
100 hp - DT100 - V4	4	91-95	1,00	BR8HCS-10	1157	-	-
100 hp - DT100 - V4	4	96-00	1,00	BR8HS-10	1134	-	-
100 hp - DT100TC		-95	1,00	BR8HCS-10	1157	-	-
100 hp - DT100TC		96-97	0,90	BR8HS	4322	BR8HIX	7001
100 hp - DT100TC		98-	1,00	BR8HS-10	1134	-	-

SUZUKI





 Modèle	Cyl.				N° STOCK		N° STOCK IX
115 hp - DF115 - 4 cyl. 4 temps	4	01-11	0,80	-	-	BKR6EIX	6418
115 hp - DT115 - 4 cyl. 2 temps	4	81-90	0,90	B8HS	5510	BR8HIX	7001
115 hp - DT115 - 4 cyl. 2 temps	4	91-97	1,00	BR8HCS-10	1157	-	-
115 hp - DT115 - 4 cyl. 2 temps	4	98-00	0,90	BR8HS	4322	BR8HIX	7001
115 hp - DT115S EFI - 4 cyl.	4	96-01	1,00	BR8HS-10	1134	-	-
115 hp - DT115STC EFI		96-01	1,00	BR8HS-10	1134	-	-
140 hp - DF140 - 4 cyl. 4 temps	4	02-11	0,80	-	-	BKR6EIX	6418
140 hp - DT140 - 4 cyl.	4	81-95	1,00	B8HS-10	5126	-	-
140 hp - DT140 - 4 cyl.	4	96-	1,00	BR8HCS-10	1157	-	-
140 hp - DT140 - 4 cyl.	4	97-00	0,90	BR8HS	4322	BR8HIX	7001
140 hp - DT140 EFI - 4 cyl.	4	97-01	1,00	BR8HS-10	1134	-	-
140 hp - DT140T		-00	1,00	BR8HCS-10	1157	-	-
140 hp - DT140T		01-	1,00	BR8HS-10	1134	-	-
140 hp - DT140TC		91-96	1,00	BR8HCS-10	1157	-	-
140 hp - DT140TC		97-	1,00	BR8HS-10	1134	-	-
140 hp - PU140 - 4 cyl.	4	89-95	1,00	BR8HCS-10	1157	-	-
140 hp - PU140 - 4 cyl.	4	96-97	1,00	BR8HS-10	1134	-	-
150 hp - DT150 - V6	6	86-97	1,00	BR8HS-10	1134	-	-
150 hp - DT150 EFI - V6	6	87-03	1,00	BR8HS-10	1134	-	-
150 hp - DT150 G / STC		-	1,00	BR8HS-10	1134	-	-
150 hp - DT150S EFI - V6	6	87-03	1,00	BR8HS-10	1134	-	-
150 hp - DT150SS - V6	6	86-88	1,00	B8HS-10	5126	-	-
150 hp - DT150SS - V6	6	89-92	1,00	BR8HS-10	1134	-	-
175 hp - DF175	4	06-11	1,00	-	-	BKR6EIX	6418
175 hp - DT175 - V6	6	87-92	1,00	BR8HS-10	1134	-	-
200 hp - DF200 - V6	6	04-	1,00	-	-	BKR6EIX	6418
200 hp - DT200 Carb. - V6	6	86-	1,00	B8HS-10	5126	-	-
200 hp - DT200 Carb. - V6	6	87-97	1,00	BR8HS-10	1134	-	-
200 hp - DT200 EFI - V6	6	87-00	1,00	BR8HS-10	1134	-	-
200 hp - DT200V Carb. - V6	6	87-88	1,00	B8HS-10	5126	-	-
200 hp - DT200V Carb. - V6	6	89-91	1,00	BR8HS-10	1134	-	-
225 hp - DT225 - V6	6	87-03	1,00	BR8HS-10	1134	-	-
225 hp - DF225 - V6	6	04-11	0,90	-	-	BKR6EIX	6418
250 hp - DF250 - V6	6	04-11	1,00	-	-	BKR6EIX	6418
300 hp - DF300 - V6	6	07-11	0,90	-	-	BKR6EIX	6418

TANAKA

Aqua Bug / Super Bug	-	0,60	BM6A	5921	-	-
Bumble Bee	92-	0,60	BM6F	6221	-	-
1.2 hp - TOB 12	72-89	0,60	BMR6A	7421	-	-
1.2 hp - TOB 120	81-98	0,60	BMR6A	7421	-	-
1.75 hp - TOB 175	81-90	0,60	BMR6A	7421	-	-
2.5 hp - TOB 25	73-79	0,60	BMR6A	7421	-	-
3.0 hp - TOB 300	81-99	0,60	BMR6A	7421	-	-
5.5 hp - TOB 550 / 550L	84-88	0,60	BPR7HS	6422	BPR7HIX	5944

TOHATSU

2.0 hp - MFS2A - 4 temps	07-08	0,60	DCPR6E	3481	DCPR6EIX	8196
2.5 hp - M2.5A	80-96	1,00	BP6HS-10	6326	-	-
2.5 hp - M2.5A	97-07	1,00	BPR6HS-10	2633	-	-
2.5 hp - M2.5A2 - 2 temps	-	1,00	BP6HS-10	6326	-	-
2.5 hp - M2.5B - 4 temps	-	0,60	DCPR6E	3481	DCPR6EIX	8196
3.5 hp - M3.5A	86-90	1,00	BP6HS-10	6326	-	-
3.5 hp - M3.5A - 4 temps	97-07	1,00	BPR6HS-10	2633	-	-
3.5 hp - M3.5 A2 / B2	-	1,00	BPR6HS-10	2633	-	-
3.5 hp - M3.5B	91-96	1,00	BP6HS-10	6326	-	-
3.5 hp - M3.5B	97-07	1,00	BPR6HS-10	2633	-	-
3.5 hp - MFS3.5A - 4 temps	07-08	0,60	DCPR6E	3481	DCPR6EIX	8196
3.5 hp - MFS3.5 A2 / B2 - 2 temps	-	1,00	BP6HS-10	6326	-	-
4.0 hp - M4C	97-	1,00	BPR7HS-10	1092	-	-
4.0 hp - MFS4A - 4 temps	00-08	0,60	DCPR6E	3481	DCPR6EIX	8196
4.0 hp - MFS4A2 - 4 temps	04-08	0,60	DCPR6E	3481	DCPR6EIX	8196
4.0 hp - MFS4B / MFS4C - 4 temps	-	0,60	DCPR6E	3481	DCPR6EIX	8196
5.0 hp - M5A2	78-83	0,60	B7HS	5110	BR7HIX	7067
5.0 hp - M5B	83-96	1,00	BP7HS-10	7829	-	-
5.0 hp - M5B - 2 temps	97-07	1,00	BPR7HS-10	1092	-	-
5.0 hp - M5BS - 2 temps	07-	1,00	BPR7HS-10	1092	-	-
5.0 hp - MFS5 / MFS5B / MFS5C - 4 temps	-	0,60	DCPR6E	3481	DCPR6EIX	8196
5.0 hp - MFS5A - 4 temps	99-07	0,60	DCPR6E	3481	DCPR6EIX	8196
5.0 hp - MFS5A2 - 4 temps	04-07	0,60	DCPR6E	3481	DCPR6EIX	8196
6.0 hp - M6B	97-	1,00	BPR7HS-10	1092	-	-
6.0 hp - MFS6A / MFS6A2 - 4 temps	04-08	0,60	DCPR6E	3481	DCPR6EIX	8196
6.0 hp - MFS6B / MFS6C - 4 temps	-	0,60	DCPR6E	3481	DCPR6EIX	8196
8.0 hp - B13B	74-76	0,60	B7HS	5110	BR7HIX	7067

	Modèle	Cyl.				N° STOCK		N° STOCK IX
8.0 hp - M8A			76-86	0,60	B7HS	5110	BR7HIX	7067
8.0 hp - M8B			86-96	1,00	BP7HS-10	7829	-	-
8.0 hp - M8B			97-07	1,00	BPR7HS-10	1092	-	-
8.0 hp - MSF8A / MFS8A3 - 4 temps			04-08	0,60	DCPR6E	3481	DCPR6EIX	8196
9.8 hp - B18D			74-76	0,60	B7HS	5110	BR7HIX	7067
9.8 hp - M9.8A			76-85	0,60	B7HS	5110	BR7HIX	7067
9.8 hp - M9.8B			00-07	1,00	BPR7HS-10	1092	-	-
9.8 hp - MSF9.8A - 4 temps			04-08	0,60	DCPR6E	3481	DCPR6EIX	8196
9.9 hp - M9.9B			82-86	0,80	B7HS-10	2129	-	-
9.9 hp - M9.9B2			86-94	0,80	B7HS-10	2129	-	-
9.9 hp - M9.9C			94-07	0,80	B7HS-10	2129	-	-
9.9 hp - M9.9D			96-07	0,80	B7HS-10	2129	-	-
9.9 hp - M9.9D2 - 2 temps			-	0,80	BR7HS-10	1098	-	-
9.9 hp - MFS9.9A - 4 temps			00-08	0,60	DCPR6E	3481	DCPR6EIX	8196
9.9 hp - MFS9.9B / MFS9.9B2 - 4 temps			04-08	0,60	DCPR6E	3481	DCPR6EIX	8196
12 hp - B18C			74-76	0,60	B7HS	5110	BR7HIX	7067
12 hp - M12A			76-80	0,60	B7HS	5110	BR7HIX	7067
12 hp - M12B			80-82	0,60	B7HS	5110	BR7HIX	7067
12 hp - M12C			82-86	0,80	B7HS-10	2129	-	-
12 hp - M12C			07-	0,80	B7HS-10	2129	-	-
15 hp - M15A			80-82	0,60	B7HS	5110	BR7HIX	7067
15 hp - M15B			82-86	0,80	B7HS-10	2129	-	-
15 hp - M15B			07-	0,80	BR7HS-10	1098	-	-
15 hp - M15B2			86-94	0,80	B7HS-10	2129	-	-
15 hp - M15C			94-96	0,80	BP7HS-10	7829	-	-
15 hp - M15C / M15D			04-07	0,80	B7HS-10	2129	-	-
15 hp - M15D			97-01	0,80	BPR7HS-10	1092	-	-
15 hp - M15D2			-	0,80	B7HS-10	2129	-	-
15 hp - MFS15A - 4 temps			00-07	0,60	DCPR6E	3481	DCPR6EIX	8196
15 hp - MFS15B / MFS15B2 - 4 temps			04-07	0,60	DCPR6E	3481	DCPR6EIX	8196
15 hp - MFS15C / MFS15D - 2 temps			-	0,80	B7HS-10	2129	-	-
15 hp - MFS15C - 4 temps			-	0,60	DCPR6E	3481	DCPR6EIX	8196
15 hp - MFS15D2 - 2 temps			-	0,80	BR7HS-10	1098	-	-
18 hp - M18A			80-83	0,60	B7HS	5110	BR7HIX	7067
18 hp - M18C			82-86	0,80	B7HS-10	2129	-	-
18 hp - M18C			07-	0,80	BR7HS-10	1098	-	-
18 hp - M18C2			86-94	0,80	B7HS-10	2129	-	-
18 hp - M18D			94-07	0,80	B7HS-10	2129	-	-
18 hp - M18E - 2 temps			96-	0,80	B7HS-10	2129	-	-
18 hp - M18E			96-99	0,80	BR7HS-10	1098	-	-
18 hp - M18E			00-01	0,80	BPR7HS-10	1092	-	-
18 hp - M18E			04-07	0,80	B7HS-10	2129	-	-
18 hp - M18E2 - 2 temps			-	0,80	B7HS-10	2129	-	-
18 hp - MFS18B / MFS18B2 - 4 temps			04-08	0,60	DCPR6E	3481	DCPR6EIX	8196
20 hp - B30C			74-76	0,60	B7HS	5110	BR7HIX	7067
20 hp - M20A2			76-80	0,60	B7HS	5110	BR7HIX	7067
20 hp - MFS20C - 4 temps			-	0,60	DCPR6E	3481	DCPR6EIX	8196
25 hp - B40A			73-76	0,60	B7HS	5110	BR7HIX	7067
25 hp - M25A2			76-83	0,60	B7HS	5110	BR7HIX	7067
25 hp - M25B			79-85	0,60	B7HS	5110	BR7HIX	7067
25 hp - M25C			84-86	0,60	B7HS	5110	BR7HIX	7067
25 hp - M25C2			86-07	0,80	B7HS-10	2129	-	-
25 hp - M25C2 - 2 temps			-	1,00	BPR7HS-10	1092	-	-
25 hp - M25C3			97-07	0,80	BR7HS-10	1098	-	-
25 hp - M25C4			00-01	0,80	BR7HS-10	1098	-	-
25 hp - M25D - 2 temps			-	0,80	B7HS-10	2129	-	-
25 hp - MFS25A / MFS25B - 4 temps			04-08	0,60	DCPR6E	3481	DCPR6EIX	8196
30 hp - M30A			79-81	0,80	B7HS-10	2129	-	-
30 hp - M30A2			81-86	0,80	B7HS-10	2129	-	-
30 hp - M30A3			86-96	0,80	B7HS-10	2129	-	-
30 hp - M30A3			97-99	0,80	BR7HS-10	1098	-	-
30 hp - M30A3			04-07	0,80	B7HS-10	2129	-	-
30 hp - M30A4			00-07	0,80	BR7HS-10	1098	-	-
30 hp - M30AK			-	0,80	B7HS	5110	BR7HIX	7067
30 hp - MFS 30A / 30B - 4 temps			04-07	0,60	DCPR6E	3481	DCPR6EIX	8196
35 hp - M35A			76-80	0,60	B7HS	5110	BR7HIX	7067
35 hp - M35B			79-82	0,60	B7HS	5110	BR7HIX	7067
35 hp - M35C			84-90	0,60	B7HS	5110	BR7HIX	7067
35 hp - M3D35B2 TLDI Jet Drive			-	0,80	IZFR6Q	91234	-	-
40 hp - M40A			73-76	0,60	B7HS	5110	BR7HIX	7067
40 hp - M40C - 2 temps	2		83-06	0,80	B7HS-10	2129	-	-
40 hp - M40C - 2 temps	2		07-	0,80	BR7HS-10	1098	-	-
40 hp - M40D			89-96	0,80	B7HS-10	2129	-	-
40 hp - M40D - 2 temps	3		97-06	0,80	BR7HS-10	1098	-	-
40 hp - M40D - 2 temps	3		07-	0,80	B7HS-10	2129	-	-

TOHATSU

Modèle
Cyl.

N° STOCK

N° STOCK IX

40 hp - M40D2 - 2 temps	3	04-07	0,80	BR7HS-10	1098	-	-
40 hp - MD40A TLDI		04-07	1,10	ZFR6F-11	4291	ZFR6FIX-11	6441
40 hp - MD40B TLDI		04-08	0,80	PZFR6H	7696	-	-
40 hp - MD40B2 TLDI		-	0,80	IZFR6Q	91234	-	-
42 hp - MFS4A2 - 4 temps		-	0,60	DCPR6E	3481	DCPR6EIX	8196
45 hp - M45A / M45A2		-	1,00	BR8HS-10	1134	-	-
50 hp - M50C - 2 temps		86-91	1,00	B8HS-10	5126	-	-
50 hp - M50C - 2 temps		04-06	1,00	B8HS-10	5126	-	-
50 hp - M50C - 2 temps		-	1,00	BR8HS-10	1134	-	-
50 hp - M50D - 2 temps	3	90-96	1,00	B8HS-10	5126	-	-
50 hp - M50D - 2 temps	3	97-06	1,00	BR8HS-10	1134	-	-
50 hp - M50D - 2 temps	3	07-	1,00	B8HS-10	5126	-	-
50 hp - M50D2		04-07	1,00	BR8HS-10	1134	-	-
50 hp - MD50A TLDI		04-07	1,10	ZFR6F-11	4291	ZFR6FIX-11	6441
50 hp - MD50B / W50 TLDI		04-08	0,80	PZFR6H	7696	-	-
50 hp - MD50B2 TLDI		-	0,80	IZFR6Q	91234	-	-
52 hp - MFS5A2S - 4 temps		-	0,60	DCPR6E	3481	DCPR6EIX	8196
55 hp - M55A		80-83	1,00	B8HS-10	5126	-	-
55 hp - M55B		80-86	1,00	B8HS-10	5126	-	-
55 hp - M55B		04-06	1,00	B8HS-10	5126	-	-
60 hp - M60A		86-91	1,00	B8HS-10	5126	-	-
60 hp - M60A		04-06	1,00	B8HS-10	5126	-	-
60 hp - M60A - 2 temps	2	-	1,00	BR8HS-10	1134	-	-
60 hp - M60B	3	92-07	1,00	B8HS-10	5126	-	-
60 hp - M60C		04-06	1,00	B8HS-10	5126	-	-
60 hp - M60C - 2 temps	3	07-	1,00	BR8HS-10	1134	-	-
62 hp - MFS6A2S - 4 temps		-	0,60	DCPR6E	3481	DCPR6EIX	8196
70 hp - M70A - 2 temps	2	82-86	1,00	B8HS-10	5126	-	-
70 hp - M70A		04-06	1,00	B8HS-10	5126	-	-
70 hp - M70A2		86-92	1,00	B8HS-10	5126	-	-
70 hp - M70A2 - 2 temps	2	04-06	1,00	B8HS-10	5126	-	-
70 hp - M70B		92-96	1,00	B8HS-10	5126	-	-
70 hp - M70B		97-06	1,00	BR8HS-10	1134	-	-
70 hp - M70B - 2 temps	3	07-	1,00	B8HS-10	5126	-	-
70 hp - M70C - 2 temps	3	00-07	1,00	BR8HS-10	1134	-	-
70 hp - MD70A2 TLDI		04-08	1,10	PZFR6H	7696	-	-
70 hp - MD70B TLDI		04-08	0,80	PZFR6H	7696	-	-
75 hp - MD75C2		-	0,80	IZFR6Q	91234	-	-
83 hp - MFS8A3 - 4 temps		-	0,60	DCPR6E	3481	DCPR6EIX	8196
90 hp - M90A - 2 temps		87-96	1,00	B8HS-10	5126	-	-
90 hp - M90A - 2 temps		97-07	1,00	BR8HS-10	1134	-	-
90 hp - MD90A / MD90A2 TLDI		04-08	1,10	PZFR6H	7696	-	-
90 hp - MD90B TLDI		04-08	0,80	PZFR6H	7696	-	-
90 hp - MD90C2 TLDI		-	0,80	IZFR6Q	91234	-	-
115 hp - M115A - 2 temps		93-95	1,00	B8HS-10	5126	-	-
115 hp - M115A - 2 temps		04-06	1,00	B8HS-10	5126	-	-
115 hp - M115A TLDI / MD115A2		-	0,80	IZFR5J	5899	-	-
115 hp - M115A2 - 2 temps		95-96	1,00	B8HS-10	5126	-	-
115 hp - M115A2 - 2 temps		97-01	1,00	BR8HS-10	1134	-	-
115 hp - M115A2 - 2 temps		04-06	1,00	BR8HS-10	1134	-	-
120 hp - M120A		90-95	1,00	B8HS-10	5126	-	-
120 hp - M120A		04-06	1,00	B8HS-10	5126	-	-
120 hp - M120A2		95-96	1,00	B8HS-10	5126	-	-
120 hp - M120A2		97-99	1,00	BR8HS-10	1134	-	-
120 hp - M120A2		07-	1,00	BR8HS-10	1134	-	-
140 hp - M140A		89-95	1,00	B8HS-10	5126	-	-
140 hp - M140A2		95-96	1,00	B8HS-10	5126	-	-
140 hp - M140A2		97-06	1,00	BR8HS-10	1134	-	-

TOMOS

18 / 18E	-	1,00	BPR7HS-10	1092	-	-
3.0 / 3.5 / 4.5 hp	-	0,60	B6HS	4510	BR6HIX	3419
4.4 hp - Electronique / 10 / 10E	-	0,60	B6HS	4510	BR6HIX	3419
5.0 hp - 5 / TS4 / Lamo 06N	-	0,60	BR7HS	4122	BR7HIX	7067
T10 / T18	-	0,60	BR7HS	4122	BR7HIX	7067
T4RN	-	0,60	B6HS	4510	BR6HIX	3419

TRITON

4.0 / 5.5 / 7.5 hp	-	0,80	XR5	3332	XR5IX	7355
--------------------	---	------	-----	------	-------	------

VALMET

Terhi 3	-	0,70	BP5S	3011	-	-
Terhi 3,5 PS	-	0,50	B6S	3510	-	-
Terhi 4.5 / 9.9 / 23 PS	-	0,50	B6HS	4510	BR6HIX	3419



Modèle

Cyl.

N°
STOCK

VALMET

N°
STOCK IX

Terhi 5 / 15 / 20 / 40, Tem 6 / 17 / 25	-	0,50	B6HS	4510	BR6HIX	3419
Terhi 50 PS	-	0,50	BP5HS	4111	-	-
Vire 7	-	0,50	B-4H	4110	-	-

VIKING

3.5 / 6.0 / 15 PS	65-71	0,80	B-6L	3212	-	-
9.2 PS	60-70	0,80	B6S	3510	-	-
9.6 / 20 / 35 / 55 PS	68-71	0,80	B6HS	4510	BR6HIX	3419

VOLVO PENTA





35 / 40 / 50 / 50A	-74	0,50	B6HS	4510	BR6HIX	3419
39	73-79	0,50	B6HS	4510	BR6HIX	3419
51	75-78	0,50	B6HS	4510	BR6HIX	3419
60	78-79	0,50	B6HS	4510	BR6HIX	3419
80 / 90	71-74	0,50	B5HS	4210	-	-
80	78-79	0,50	B5HS	4210	-	-
90 / 140	75-79	0,50	B6HS	4510	BR6HIX	3419
120	74-	0,50	B5HS	4210	-	-
140	72-74	0,50	B5HS	4210	-	-
200	75-79	-	BUHX	2522	-	-
250	-75	-	BUHX	2522	-	-
252	73-74	0,50	BP7HS	5111	BPR7HIX	5944
350	75-76	0,50	B8HS	5510	BR8HIX	7001
360	71-74	0,50	B6HS	4510	BR6HIX	3419
450	71-74	0,50	B8HS	5510	BR8HIX	7001
450	75-76	-	BUHX	2522	-	-
550X	-74	0,50	B8HS	5510	BR8HIX	7001
600	73-76	-	BUHX	2522	-	-
700	73-77	-	BUHX	2522	-	-
U22	-74	0,50	B5HS	4210	-	-





WIZARD

3.0 / 3.5 hp	70-74	0,80	XR5	3332	XR5IX	7355
3.0 hp	76-	0,80	XR5	3332	XR5IX	7355
3.2 hp - WD3 / WD3S	-	0,60	B6S	3510	-	-
4.5 / 5.5 hp	75-76	0,80	XR5	3332	XR5IX	7355
5.0 / 7.0 hp	70-74	0,90	XR5	3332	XR5IX	7355
5.0 hp	77-81	0,80	XR5	3332	XR5IX	7355
5.0 hp - WH6 / WH6-1 / WH6A	-	0,60	B6S	3510	-	-
5.5 hp - OC575 / OC585	-	0,80	B6S	3510	-	-
6.0 hp	59-71	0,80	B-6L	3212	-	-
6.0 hp - WD4 / WD4S / WF4 / WG4	-	0,60	B6S	3510	-	-
7.5 hp	70-81	0,80	XR5	3332	XR5IX	7355
9.2 hp	66-71	0,80	B8S	3810	-	-
9.9 hp	70-78	0,80	XR5	3332	XR5IX	7355
10 hp - WF7 / WG7 / WG7A / WH7 / WJ7	-	0,60	B6S	3510	-	-
10 hp - WK7 / WM7 / WM7A / WN7 / WN7A	-	0,60	B6S	3510	-	-
12 hp	-	0,60	B6S	3510	-	-
14 hp	59-64	0,60	B6S	3510	-	-
15 hp - OC1575 / OC1585	-	0,80	B-6L	3212	-	-
20 hp	68-71	0,80	B8HS	5510	BR8HIX	7001
25 hp - WA25 / WA25E	-	0,60	B6S	3510	-	-
35 hp - OC3585	-	0,80	AB-7	3010	-	-

YAMAHA

V6 Excel	6	87-89	1,00	BR9HS-10	4551	-	-
2.0 hp - 1 cyl.	1	84-02	0,60	B5HS	4210	-	-
2.0 hp - 2B 2 temps 43cc	-	-	0,70	BR5HS	3722	-	-
2.0 hp - 2C 2 temps 50cc	95-	-	0,60	BR7HS	4122	BR7HIX	7067
2.5 hp - F2.5 4 temps	03-05	-	0,60	BR6HS	3922	BR6HIX	3419
2.5 hp - F2.5 MSH	06-10	-	0,60	BR6HS	3922	BR6HIX	3419
2.5 hp - F2.5A 4 temps	-	-	0,60	BR6HS	3922	BR6HIX	3419
3.0 hp - 1 cyl.	1	88-02	1,00	B6HS-10	1052	-	-
3.0 hp - 3A 2 temps 83cc	1	-	1,00	BR6HS-10	1090	-	-
4.0 hp - 1 cyl.	1	84-99	0,60	B7HS	5110	BR7HIX	7067
4.0 hp - 4A / 4AC / 4AS / 4BC	-	-	0,60	BR7HS	4122	BR7HIX	7067
4.0 hp - F4 1 cyl. 4 temps	1	99-05	0,60	BR6HS	3922	BR6HIX	3419
4.0 hp - F4A 1 cyl. 4 temps 112cc	1	03-	0,70	BR6HS	3922	BR6HIX	3419
4.0 hp - F4B 1 cyl. 4 temps 139cc	1	10-	0,70	CR6HSB	6500	-	-
5.0 hp - 1 cyl.	1	84-02	0,60	B7HS	5110	BR7HIX	7067
5.0 hp - 5C / 5CS	1	-	0,60	BR7HS	4122	BR7HIX	7067
5.0 hp - F5A 1 cyl. 4 temps 139cc	1	10-	0,70	CR6HSB	6500	-	-
6.0 hp - 2 cyl.	2	86-00	1,00	B7HS-10	2129	-	-

	Modèle	Cyl.				N° STOCK		N° STOCK IX
6.0 hp - 6D 2 temps 165cc			86-07	1,00	B6HS-10	1052	-	-
6.0 hp - F6 OHV 4 temps			01-05	1,00	BR6HS-10	1090	-	-
6.0 hp - F6A / F6M			06-10	1,00	BR6HS-10	1090	-	-
6.0 hp - F6B 4 temps 197cc			00-06	1,00	BR6HS-10	1090	-	-
6.0 hp - F6C 1 cyl. 4 temps 139cc		1	10-	1,00	BR6HS-10	1090	-	-
8.0 hp - 2 cyl. 2 temps		2	86-05	1,00	B7HS-10	2129	-	-
8.0 hp - 8C 1 cyl. 2 temps		1	86-	1,00	BR7HS-10	1098	-	-
8.0 hp - 8MSH			06-10	1,00	B7HS-10	2129	-	-
8.0 hp - E8D Enduro 2 temps 165cc			86-	1,00	B7HS-10	2129	-	-
8.0 hp - EK8D Enduro 2 temps 165cc			88-	0,70	B6HS	4510	BR6HIX	3419
8.0 hp - F8 OHV 4 temps			01-05	1,00	BR6HS-10	1090	-	-
8.0 hp - F8 A / AEM / AM / B / BE / BM			86-	0,90	CR5HSA	7840	CR5HIX	7120
8.0 hp - F8C / F8M			06-10	1,00	BR6HS-10	1090	-	-
8.0 hp - FT8D 4 temps 197cc			01-	1,00	BR6HS-10	1090	-	-
8.0 hp - T8			06-10	1,00	BR6HS-10	1090	-	-
8.0 hp - T8 OHV 4 temps High Thrust			01-05	1,00	BR6HS-10	1090	-	-
9.0 hp - 9.9 2 cyl. 2 temps		2	84-05	1,00	B7HS-10	2129	-	-
9.0 hp - F / FT 9.9 2 cyl. OHC 4 temps Standard		2	85-04	0,60	CR6HS	7023	CR6HIX	7274
9.0 hp - F / FT 9.9 2 cyl. OHC 4 temps Standard		2	05-	0,90	DPR6EA-9	5531	-	-
9.0 hp - F / FT 9.9 Climat Froid OHC 4 temps Standard		2	85-04	0,60	-	-	CR6HIX	7274
9.0 hp - T9.9 2 cyl. OHC 4 temps High Thrust		2	85-04	0,60	CR6HS	7023	CR6HIX	7274
9.0 hp - T9.9 2 cyl. OHC 4 temps High Thrust		2	05-	0,90	DPR6EA-9	5531	-	-
9.0 hp - T9.9 Climat Froid OHC 4 temps High Thrust		2	85-04	0,60	-	-	CR6HIX	7274
9.9 hp - 9.9D 2 cyl. 2 temps 246cc		2	-95	1,00	B7HS-10	2129	-	-
9.9 hp - 9.9D 2 cyl. 4 temps		2	05-	1,00	B7HS-10	2129	-	-
9.9 hp - 9.9F 2 cyl. 2 temps 246cc		2	96-	1,00	B7HS-10	2129	-	-
9.9 hp - 9.9MSH			06-10	1,00	B7HS-10	2129	-	-
9.9 hp - E9.9B Enduro 2 temps 246cc			88-96	1,00	B7HS-10	2129	-	-
9.9 hp - E9.9C Enduro 2 temps 246cc			97-02	1,00	B7HS-10	2129	-	-
9.9 hp - E9.9D Enduro 2 temps 246cc			02-	1,00	B8HS-10	5126	-	-
9.9 hp - EK9.9D / EK9.9J Enduro 2 temps 246cc			03-	1,00	B7HS-10	2129	-	-
9.9 hp - EK9.9H Enduro 2 temps 246cc			03-04	1,00	B7HS-10	2129	-	-
9.9 hp - F9.9B 4 temps 232cc			91-07	0,70	CR6HSA	2983	CR6HIX	7274
9.9 hp - F9.9C 4 temps 323cc			98-08	0,90	DPR6EA-9	5531	-	-
9.9 hp - F9.9D 2 cyl. 4 temps		2	05-	0,90	CR6HSA	2983	CR6HIX	7274
9.9 hp - F9.9 ELR, MLH, MSH			06-10	0,90	CR6HSA	2983	CR6HIX	7274
9.9 hp - F9.9 ELR2, ELR2K			06-10	0,90	DPR6EA-9	5531	-	-
9.9 hp - F9.9F 2 cyl. 4 temps 212cc		2	06-10	1,00	BR6HS-10	1090	-	-
9.9 hp - F9.9H 4 temps 362cc			09-	0,90	DPR6EB-9	3108	-	-
9.9 hp - F9.9 MLH2, MLH2K, MSH2, MSH2K			06-10	0,90	DPR6EA-9	5531	-	-
9.9 hp - FT9.9A 4 temps 232cc			98-07	0,70	CR6HSA	2983	CR6HIX	7274
9.9 hp - FT9.9D 4 temps 323cc			03-06	0,90	DPR6EA-9	5531	-	-
9.9 hp - FT9.9G 2 cyl. 4 temps 212cc		2	07-	1,00	BR6HS-10	1090	-	-
9.9 hp - T9.9D 2 cyl. 4 temps		2	05-	0,90	CR6HSA	2983	CR6HIX	7274
9.9 hp - T9.9ELH, ELR, EXH			06-10	0,90	CR6HSA	2983	CR6HIX	7274
9.9 hp - T9.9 ELH2/2K, ELR2/2K, EXH2/H2K			06-10	0,90	DPR6EA-9	5531	-	-
13.5 hp - F13.5A 4 temps 323cc			01-07	0,90	DPR6EA-9	5531	-	-
13.5 hp - F13.5B 4 temps 362cc			07-09	0,90	DPR6EB-9	3108	-	-
15 hp - 2 cyl.		2	84-05	1,00	B7HS-10	2129	-	-
15 hp - 15D 2 temps 246cc			-95	1,00	B7HS-10	2129	-	-
15 hp - 15F 2 cyl. 2 temps 246cc			96-	1,00	B7HS-10	2129	-	-
15 hp - 15MSH			06-10	1,00	B7HS-10	2129	-	-
15 hp - E15B Enduro 2 temps 246cc			88-96	1,00	B7HS-10	2129	-	-
15 hp - E15C Enduro 2 temps 246cc			97-02	1,00	B7HS-10	2129	-	-
15 hp - E15D Enduro 2 temps 246cc			02-	1,00	B7HS-10	2129	-	-
15 hp - EK15D / EK15P Enduro 2 temps 246cc			03-	1,00	B7HS-10	2129	-	-
15 hp - EK15H / EK15J Enduro 2 temps 246cc			89-96	1,00	B7HS-10	2129	-	-
15 hp - EK15N Enduro 2 temps 246cc			94-04	1,00	B7HS-10	2129	-	-
15 hp - F15 2 cyl. 4 temps		2	98-04	0,90	DPR6EA-9	5531	-	-
15 hp - F15A 2 cyl. 4 temps 323cc		2	03-06	0,90	DPR6EA-9	5531	-	-
15 hp - F15B 2 cyl. 4 temps 323cc		2	03-08	0,90	DPR6EA-9	5531	-	-
15 hp - F15C 2 cyl. 4 temps 362cc		2	06-10	0,90	DPR6EB-9	3108	-	-
15 hp - F15 E / M / P			06-10	0,90	DPR6EA-9	5531	-	-
20 hp - 2 cyl.		2	96-97	1,00	B7HS-10	2129	-	-
20 hp - 20C - 2 cyl. 2 temps 430cc		2	96-07	0,60	BR7HS	4122	BR7HIX	7067
20 hp - 20D - 2 cyl. 2 temps 395cc		2	88-	1,00	B7HS-10	2129	-	-
20 hp - EK20F Enduro 2 temps 430cc		2	-93	0,70	B6HS	4510	BR6HIX	3419
20 hp - F20			06-10	0,90	DPR6EB-9	3108	-	-
20 hp - F20A 4 temps 498cc			98-09	0,90	DPR6EA-9	5531	-	-
20 hp - F20B 2 cyl. 4 temps 362cc		2	06-	0,90	DPR6EB-9	3108	-	-
20 hp - F20C 4 temps 362cc			08-	0,90	DPR6EB-9	3108	-	-
20 hp - F20D 4 temps 498cc			11-	0,90	DPR6EB-9	3108	-	-
25 hp - 2 cyl. 2 temps		2	84-05	1,00	B7HS-10	2129	-	-
25 hp - 3 cyl. 2 temps		3	96-02	1,00	B7HS-10	2129	-	-
25 hp - 25			06-10	1,00	B7HS-10	2129	-	-

	Modèle	Cyl.				N° STOCK		N° STOCK IX
25 hp - 25B 2 cyl. 2 temps 496cc		2	07-	1,00	B7HS-10	2129	-	-
25 hp - 25C 2 cyl.		2	90-97	0,60	B7HS	5110	BR7HIX	7067
25 hp - 25D 2 temps 430cc			90-03	0,70	B7HS	5110	BR7HIX	7067
25 hp - 25J 2 temps			87-03	1,00	B7HS-10	2129	-	-
25 hp - 25N 2 cyl. 2 temps 395cc		2	88-	1,00	B7HS-10	2129	-	-
25 hp - 25Q 2 temps			-95	1,00	B7HS-10	2129	-	-
25 hp - 25V 2 temps			92-01	1,00	B7HS-10	2129	-	-
25 hp - 25X 2 temps			01-	1,00	B8HS-10	5126	-	-
25 hp - E25A Enduro 2 temps 496cc			-01	1,00	B7HS-10	2129	-	-
25 hp - E25B Enduro 2 temps 496cc			01-	1,00	B7HS-10	2129	-	-
25 hp - E25F / EK25F Enduro 2 temps 430cc			-93	0,70	B7HS	5110	BR7HIX	7067
25 hp - EK25B Enduro 2 temps 496cc			03-	1,00	B7HS-10	2129	-	-
25 hp - EK25C Enduro 2 temps 496cc			06-	1,00	B7HS-10	2129	-	-
25 hp - F25 2 cyl. OHC 4-temps		2	98-05	0,90	DPR6EA-9	5531	-	-
25 hp - F25A 2 cyl. 4 temps 498cc		2	03-	0,90	DPR6EA-9	5531	-	-
25 hp - F25C 4 temps 498cc		2	03-09	0,90	DPR6EA-9	5531	-	-
25 hp - F25D 4 temps 498cc		2	10-	0,90	DPR6EB-9	3108	-	-
25 hp - F25 E / M / T			06-10	0,90	DPR6EA-9	5531	-	-
25 hp - F25 L / S			06-10	0,90	DPR6EB-9	3108	-	-
25 hp - FT25B 4 temps 498cc			00-09	0,90	DPR6EA-9	5531	-	-
25 hp - FT25F 2 cyl. 4 temps 498cc		2	09-	0,90	DPR6EB-9	3108	-	-
25 hp - T25 2 cyl. OHC 4 temps High Thrust		2	01-05	0,90	DPR6EA-9	5531	-	-
25 hp - T25LA			06-10	0,90	DPR6EB-9	3108	-	-
25 hp - T25TLR			06-10	0,90	DPR6EA-9	5531	-	-
28 hp - 3 cyl.		3	87-97	1,00	B7HS-10	2129	-	-
30 hp - 3 cyl.		3	84-86	0,60	B7HS	5110	BR7HIX	7067
30 hp - 3 cyl.		3	87-02	1,00	B7HS-10	2129	-	-
30 hp - 30A 2 temps 496cc			-92	0,70	B7HS	5110	BR7HIX	7067
30 hp - 30C 2 cyl.		2	89-92	0,60	B7HS	5110	BR7HIX	7067
30 hp - 30C 2 cyl.		2	93-97	1,00	B8HS-10	5126	-	-
30 hp - 30D 3 cyl. 2 temps 496cc		3	86-	1,00	B7HS-10	2129	-	-
30 hp - 30G 2 temps 496cc			93-01	1,00	B7HS-10	2129	-	-
30 hp - 30H / E30H Enduro 2 cyl. 2 temps 496cc		2	01-	1,00	B8HS-10	5126	-	-
30 hp - F30 OHC 4-temps			01-05	0,90	DPR6EA-9	5531	-	-
30 hp - F30A			-02	0,90	DPR6EA-9	5531	-	-
30 hp - F30A 3 cyl. 4 temps 747cc		3	03-09	0,90	DPR6EA-9	5531	-	-
30 hp - F30B 3 cyl. 4 temps 747cc		3	09-	0,90	DPR6EB-9	3108	-	-
30 hp - F30E / F30T			06-	0,90	DPR6EA-9	5531	-	-
30 hp - F30TLR			06-10	0,90	DPR6EA-9	5531	-	-
35 hp - 3 cyl.		3	87-97	1,00	B8HS-10	5126	-	-
40 hp - 3 cyl. 2 temps		3	84-05	1,00	B7HS-10	2129	-	-
40 hp - 40C 2 cyl.		2	89-97	0,60	B8HS	5510	BR8HIX	7001
40 hp - 40C 3 cyl.		3	97-02	1,00	B7HS-10	2129	-	-
40 hp - 40H 2 temps 698cc			-94	1,00	B7HS-10	2129	-	-
40 hp - 40J / E40J Enduro 2 temps 669cc			83-	0,70	B7HS	5110	BR7HIX	7067
40 hp - 40Q 2 temps 592cc			-98	0,70	B8HS	5510	BR8HIX	7001
40 hp - 40TLR			06-10	1,00	B7HS-10	2129	-	-
40 hp - 40V 3 cyl. 2 temps 698cc		3	95-	1,00	B7HS-10	2129	-	-
40 hp - 40X / E40X Enduro 2 cyl. 2 temps 703cc		2	98-	0,70	B7HS	5110	BR7HIX	7067
40 hp - 40Y 2 temps 698cc			01-	1,00	BR8HS-10	1134	-	-
40 hp - E40G Enduro 2 temps 669cc			82-	0,70	B7HS	5110	BR7HIX	7067
40 hp - EK40G / EK40J Enduro 2 temps 669cc			98-	0,70	B7HS	5110	BR7HIX	7067
40 hp - F40 3 cyl. 4 temps		3	00-05	0,90	DPR6EA-9	5531	-	-
40 hp - F40 4 cyl. 4 temps		4	99-	0,90	DPR6EA-9	5531	-	-
40 hp - F40A 4 temps 935cc			98-02	0,90	DPR6EA-9	5531	-	-
40 hp - F40B 3 cyl. 4 temps 747cc			03-09	0,90	DPR6EA-9	5531	-	-
40 hp - F40C 4 temps 996cc			00-07	0,90	DPR5EA-9	2887	-	-
40 hp - F40D 4 temps 996cc			06-	0,90	DPR6EB-9	3108	-	-
40 hp - F40E / F40T			06-	0,90	DPR6EA-9	5531	-	-
40 hp - F40F 3 cyl. EFI 4 temps 747cc		3	09-	0,90	DPR6EB-9	3108	-	-
40 hp - F40G 4 temps 996cc			11-	0,90	LKR7E	1643	-	-
40 hp - F40 J / L			06-10	0,90	DPR6EB-9	3108	-	-
48 hp - E48 2 cyl.		2	95-00	0,60	B7HS	5110	BR7HIX	7067
48 hp - E48C Enduro 2 temps 760cc			92-	0,70	B7HS	5110	BR7HIX	7067
50 hp - 3 cyl. 2 temps		3	84-05	1,00	BR8HS-10	1134	-	-
50 hp - 50TLR			06-10	1,00	B8HS-10	5126	-	-
50 hp - 50C 3 cyl.		3	98-	1,00	BR8HS-10	1134	-	-
50 hp - 50C 3 cyl.		3	99-01	0,60	B8HS	5510	BR8HIX	7001
50 hp - 50D 2 temps 698cc			-94	1,00	B8HS-10	5126	-	-
50 hp - 50EK Enduro 2 temps 849cc			88-97	1,00	B8HS-10	5126	-	-
50 hp - 50G 2 temps 849cc			93-07	1,00	BR8HS-10	1134	-	-
50 hp - 50H 3 cyl. 2 temps 698cc			95-	1,00	B8HS-10	5126	-	-
50 hp - F50 4 cyl. 4 temps OHC Standard		4	95-04	0,90	DPR6EA-9	5531	-	-
50 hp - F50 (EFI) 4 cyl. 4 temps OHC Standard		4	05-	0,90	DPR6EB-9	3108	-	-
50 hp - F50A 4 cyl. 4 temps 935cc		4	03-05	0,90	DPR6EA-9	5531	-	-



Modèle

Cyl.





N° STOCK



N° STOCK IX

50 hp - F50B		-02	0,90	DPR6EA-9	5531	-	-
50 hp - F50D 4 temps 935cc		01-	0,90	DPR6EA-9	5531	-	-
50 hp - F50F 4 cyl. EFI 4 temps 996cc	4	04-	0,90	DPR6EB-9	3108	-	-
50 hp - FT50B 4 temps 935cc		98-06	0,90	DPR6EA-9	5531	-	-
50 hp - FT50C 4 temps 935cc		01-	0,90	DPR6EA-9	5531	-	-
50 hp - FT50G 4 temps 996cc		05-	0,90	DPR6EB-9	3108	-	-
50 hp - F50TLR		06-10	0,90	DPR6EB-9	3108	-	-
50 hp - P503 cyl.	3	87-96	1,00	BR8HS-10	1134	-	-
50 hp - T50 (EFI) 4 cyl. 4 temps OHC High Thrust	4	05-	0,90	DPR6EB-9	3108	-	-
50 hp - T50 4 cyl. 4 temps OHC High Thrust	4	95-04	0,90	DPR6EA-9	5531	-	-
50 hp - T50LRD4 cyl. 4 temps OHC High Thrust	4	96-04	0,90	DPR6EB-9	3108	-	-
50 hp - T50TLR		06-10	0,90	DPR6EB-9	3108	-	-
55 hp - 55B 2 temps 760cc		89-	1,00	B8HS-10	5126	-	-
55 hp - 55C 2 cyl.	2	89-95	1,00	B8HS-10	5126	-	-
55 hp - 55D 2 temps 1140cc		98-	1,00	B8HS-10	5126	-	-
55 hp - E55C Enduro 2 temps 760cc		92-	0,70	B8HS	5510	BR8HIX	7001
60 hp - 2 temps		01-05	1,00	B8HS-10	5126	-	-
60 hp - 60C 3 cyl.	3	96-02	1,00	B8HS-10	5126	-	-
60 hp - 60F 3 cyl. 2 temps 849cc	3	92-	1,00	B8HS-10	5126	-	-
60 hp - 60TLR		06-10	1,00	B8HS-10	5126	-	-
60 hp - E60 3 cyl.	3	95-00	1,00	B8HS-10	5126	-	-
60 hp - E60H Enduro 3 cyl. 2 temps 849cc	3	86-	1,00	B8HS-10	5126	-	-
60 hp - E60J Enduro 2 temps 1140cc		95-	1,00	B8HS-10	5126	-	-
60 hp - F60A 4 cyl. 4 temps 996cc	4	03-05	0,90	DPR5EA-9	2887	-	-
60 hp - F60C EFI 4 cyl. 4 temps	4	04-	0,90	DPR6EB-9	3108	-	-
60 hp - F60TJR, TLR		06-10	0,90	DPR6EB-9	3108	-	-
60 hp - FT60B 4 cyl. 4 temps 996cc	4	02-07	0,90	DPR5EA-9	2887	-	-
60 hp - FT60D 4 cyl. EFI 4 temps 996cc	4	07-	0,90	DPR6EB-9	3108	-	-
60 hp - P60 3 cyl.	3	91-99	1,00	B8HS-10	5126	-	-
60 hp - T60 4 temps		03-04	0,90	DPR5EA-9	2887	-	-
60 hp - T60 (EFI) 4 temps		05-	0,90	DPR6EB-9	3108	-	-
60 hp - T60TLR		06-10	0,90	DPR6EB-9	3108	-	-
65 hp - 3 cyl.	3	87-97	1,00	B8HS-10	5126	-	-
65 hp - E65A Enduro 2 temps 1140cc		98-	1,00	BR8HS-10	1134	-	-
70 hp - 3 cyl. 2 temps	3	84-05	1,00	B8HS-10	5126	-	-
70 hp - 70B 3 cyl. 2 temps 849cc	3	92-	1,00	B8HS-10	5126	-	-
70 hp - 70C 3 cyl. 2 temps 847cc	3	92-01	1,00	B8HS-10	5126	-	-
70 hp - 70LTR		06-10	1,00	B8HS-10	5126	-	-
70 hp - F70A 4 temps 996cc		11-	0,90	LKR7E	1643	-	-
75 hp - 75A 3 cyl. 2 temps 1140cc	3	94-04	1,00	B8HS-10	5126	-	-
75 hp - 75C 3 cyl. 1140cc	3	96-	1,00	B8HS-10	5126	-	-
75 hp - E75 3 cyl.	3	95-00	1,00	B8HS-10	5126	-	-
75 hp - E75B Enduro 2 temps 1140cc		91-	1,00	B8HS-10	5126	-	-
75 hp - F75A 4 temps 1596cc		02-04	1,10	LFR5A-11	6376	LFR5AIX-11	4469
75 hp - F75B 4 temps 1596cc		05-	1,10	LFR5A-11	6376	LFR5AIX-11	4469
75 hp - F75TLR		06-10	1,10	LFR5A-11	6376	LFR5AIX-11	4469
75 hp - P75 3 cyl.	3	96-99	1,00	B8HS-10	5126	-	-
80 hp - 80A 2 temps 1140cc		92-03	1,00	B8HS-10	5126	-	-
80 hp - 80C 3 cyl.	3	97-	1,00	B8HS-10	5126	-	-
80 hp - F80 3 cyl.	3	99-02	1,10	LFR5A-11	6376	LFR5AIX-11	4469
80 hp - F80A 4 cyl. 4 temps 1596cc	4	03-05	1,10	LFR5A-11	6376	LFR5AIX-11	4469
80 hp - F80B 4 cyl. EFI 4 temps 1596cc	4	04-	1,10	LFR5A-11	6376	LFR5AIX-11	4469
80 hp - F80C 4 cyl. 4 temps 1596cc	4	09-	1,10	LFR5A-11	6376	LFR5AIX-11	4469
85 hp - 85A 3 cyl. 2 temps 1140cc	3	89-04	1,00	B8HS-10	5126	-	-
85 hp - 85C 3 cyl.	3	89-96	1,00	B8HS-10	5126	-	-
90 hp - 3 cyl. 2 temps	3	84-05	1,00	B8HS-10	5126	-	-
90 hp - 90A 3 cyl. 2 temps 1140cc	3	92-	1,00	B8HS-10	5126	-	-
90 hp - 90B 3 cyl.	3	98-99	1,00	B8HS-10	5126	-	-
90 hp - 90C 3 cyl.	3	97-01	1,00	B8HS-10	5126	-	-
90 hp - 90TLR		06-10	1,00	B8HS-10	5126	-	-
90 hp - F90 4 temps		03-05	1,10	LFR5A-11	6376	LFR5AIX-11	4469
90 hp - F90A 4 temps 1596cc		02-04	1,10	LFR5A-11	6376	LFR5AIX-11	4469
90 hp - F90B 4 temps 1596cc		05-	1,10	LFR5A-11	6376	LFR5AIX-11	4469
90 hp - F90TJR, TLR, TXR		06-10	1,10	LFR5A-11	6376	LFR5AIX-11	4469
100 hp - 100A 2 temps 1730cc		96-01	1,00	B8HS-10	5126	-	-
100 hp - F100		99-02	1,10	LFR5A-11	6376	LFR5AIX-11	4469
100 hp - F100A 4 cyl. 4 temps 1596cc	4	99-05	1,10	LFR5A-11	6376	LFR5AIX-11	4469
100 hp - F100B 4 cyl. 4 temps 1596cc	4	02-	1,10	LFR5A-11	6376	LFR5AIX-11	4469
100 hp - F100C 4 cyl. 4 temps 1596cc	4	02-07	1,10	LFR5A-11	6376	LFR5AIX-11	4469
100 hp - F100C 4 cyl. EFI 4 temps 1596cc	4	05-	1,10	LFR5A-11	6376	LFR5AIX-11	4469
115 hp - 115 / P115 V4 - 1.7L	4	84-05	1,00	BR8HS-10	1134	-	-
115 hp - 115B V4 - 1.7L	4	98-99	1,00	BR8HS-10	1134	-	-
115 hp - 115C V4 - 1.7L	4	91-00	1,00	BR8HS-10	1134	-	-
115 hp - 115TJR V4 - 1.7L	4	87-97	1,00	BR8HS-10	1134	-	-
115 hp - 115TLR, TXR		06-10	1,00	BR8HS-10	1134	-	-
115 hp - E115A Enduro 2 temps 1730cc	4	92-	1,00	B8HS-10	5126	-	-
115 hp - F115 V4 - 1.7L	4	00-05	1,10	LFR6A-11	3672	LFR6AIX-11	6619

Modèle	Cyl.	0201			N° STOCK	IX	
							N° STOCK IX
115 hp - F115TJR, TLR, TXR		06-10	1,10	LFR6A-11	3672	LFR6AIX-11	6619
115 hp - FL115A V4 EFI 4 temps 1741cc	4	00-	1,10	LFR6A-11	3672	LFR6AIX-11	6619
115 hp - LF115 V4 - 1.7L	4	00-05	1,10	LFR6A-11	3672	LFR6AIX-11	6619
115 hp - LF115TXR		06-10	1,10	LFR6A-11	3672	LFR6AIX-11	6619
115 hp - S115 V4 - 1.7L	4	84-99	1,00	BR8HS-10	1134	-	-
130 hp - 130 V4 - 1.7L	4	88-04	1,00	BR9HS-10	4551	-	-
130 hp - 130B V4 - 2 temps 1.7L	4	91-	1,00	BR9HS-10	4551	-	-
130 hp - L130 V4 - 1.7L	4	89-01	1,00	BR9HS-10	4551	-	-
130 hp - L130B V4 - 2 temps 1.7L	4	91-	1,00	BR9HS-10	4551	-	-
130 hp - S130 V4 - 1.7L	4	88-99	1,00	BR9HS-10	4551	-	-
140 hp - 140B 2 temps 1730cc		92-	1,00	B9HS-10	3626	-	-
140 hp - 140C 2 temps 1730cc		93-03	1,00	B9HS-10	3626	-	-
150 hp - 150 V6 - 2.6L	6	84-87	1,00	BR7HS-10	1098	-	-
150 hp - 150 V6 - 2.6L	6	88-95	1,00	BR8HS-10	1134	-	-
150 hp - 150 V6 - 2.6L	6	96-04	1,00	BR7HS-10	1098	-	-
150 hp - 150A 2 temps 2596cc		83-	1,00	B8HS-10	5126	-	-
150 hp - 150C 2 temps 2596cc		90-95	1,00	B8HS-10	5126	-	-
150 hp - 150C V6 - 2.6L	6	96-	1,00	BR7HS-10	1098	-	-
150 hp - 150C V6 - 2.6L	6	97-99	1,00	BR8HS-10	1134	-	-
150 hp - 150D 2 temps 2596cc		91-95	1,00	B8HS-10	5126	-	-
150 hp - 150F / 150G V6 2 temps 2596cc	6	96-	1,00	BR7HS-10	1098	-	-
150 hp - 150J V6 2 temps 2596cc	6	00-06	1,00	BR7HS-10	1098	-	-
150 hp - 150L V6 2 temps 2596cc	6	00-05	1,00	BR7HS-10	1098	-	-
150 hp - 150TJR V6 - 2.6L	6	96-97	1,00	BR7HS-10	1098	-	-
150 hp - 150TXR		06-10	1,00	BR7HS-10	1098	-	-
150 hp - D150 V6 - 2.6L	6	97-99	1,00	BR8HS-10	1134	-	-
150 hp - D150H 2 temps 2596cc	6	98-03	1,00	BR8HS-10	1134	-	-
150 hp - D150N 2 temps 2596cc	6	00-05	1,00	BR7HS-10	1098	-	-
150 hp - D150 Twin Prop V6 - 2.6L	6	86-93	1,00	B8HS-10	5126	-	-
150 hp - DX150 V6 - 2.6L	6	99-05	1,00	BR7HS-10	1098	-	-
150 hp - F150 - 4 temps		04-05	1,10	LFR5A-11	6376	LFR5AIX-11	4469
150 hp - F150A / FL150A 4 cyl. EFI 4 temps 2670cc	4	03-	1,10	LFR5A-11	6376	LFR5AIX-11	4469
150 hp - F150B / FL150B 4 cyl. EFI 4 temps 2670cc	4	09-	1,10	LFR5A-11	6376	LFR5AIX-11	4469
150 hp - F150TJR, TLR, TXR		06-10	1,10	LFR5A-11	6376	LFR5AIX-11	4469
150 hp - L150 V6 - 2.6L	6	86-87	1,00	BR7HS-10	1098	-	-
150 hp - L150 V6 - 2.6L	6	88-95	1,00	BR8HS-10	1134	-	-
150 hp - L150A 2 temps 2596cc		83-	1,00	B8HS-10	5126	-	-
150 hp - L150C 2 temps 2596cc		90-95	1,00	B8HS-10	5126	-	-
150 hp - L150F V6 2 temps 2596cc	6	96-	1,00	BR7HS-10	1098	-	-
150 hp - L150J V6 2 temps 2596cc	6	00-06	1,00	BR7HS-10	1098	-	-
150 hp - LF150 V6 - 2.6L	6	04-05	1,10	LFR5A-11	6376	LFR5AIX-11	4469
150 hp - LF150TXR		06-10	1,10	LFR5A-11	6376	LFR5AIX-11	4469
150 hp - LX150 V6 - 2.6L	6	99-04	0,60	BR7HS	4122	BR7HIX	7067
150 hp - LZ150 V6 - 2.6L	6	02-05	0,60	BKR6EKU	6993	-	-
150 hp - LZ150P V6 DFI 2 temps 2596cc	6	00-	0,60	BKR6EKU	6993	-	-
150 hp - LZ150TX HPDI (->800554)		00-01	1,10	BKR6ES-11	5553	BKR6EIX-11	3764
150 hp - LZ150TX HPDI (800555->)		01-	0,60	BKR6EKU	6993	-	-
150 hp - LZ150TXR		06-10	0,60	BKR6EKU	6993	-	-
150 hp - P150 V6 - 2.6L	6	86-95	1,00	BR8HS-10	1134	-	-
150 hp - P150 V6 - 2.6L	6	96-99	1,00	BR7HS-10	1098	-	-
150 hp - PX150 V6 - 2.6L	6	99-	0,60	BR7HS	4122	BR7HIX	7067
150 hp - S150 V6 - 2.6L	6	94-99	1,00	BR7HS-10	1098	-	-
150 hp - S150F / SL150F V6 2 temps 2596cc	6	97-	1,00	BR7HS-10	1098	-	-
150 hp - SX150 V6 - 2.6L	6	99-04	1,00	BR7HS-10	1098	-	-
150 hp - V150 V6 - 2.6L	6	99-05	1,00	BR7HS-10	1098	-	-
150 hp - V150TLR		06-10	1,00	BR7HS-10	1098	-	-
150 hp - VX150 V6 - 2.6L	6	00-05	1,00	BR7HS-10	1098	-	-
150 hp - VZ150 HPDI		02-05	0,60	BKR6EKU	6993	-	-
150 hp - VZ150T HPDI (-> 800711)		00-01	1,10	BKR6ES-11	5553	BKR6EIX-11	3764
150 hp - VZ150T HPDI (800712->)		01-	0,60	BKR6EKU	6993	-	-
150 hp - VZ150TLR		06-10	0,60	BKR6EKU	6993	-	-
150 hp - Z150P DFI / Z150Q V6 2 temps 2596cc	6	00-	0,60	BKR6EKU	6993	-	-
150 hp - Z150TL HPDI		02-05	0,60	BKR6EKU	6993	-	-
150 hp - Z150TL HPDI (->800452)		00-01	1,10	BKR6ES-11	5553	BKR6EIX-11	3764
150 hp - Z150TL HPDI (800453->)		01-	0,60	BKR6EKU	6993	-	-
150 hp - Z150TX HPDI (->851535)		00-01	1,10	BKR6ES-11	5553	BKR6EIX-11	3764
150 hp - Z150TX HPDI (851536->)		01-	0,60	BKR6EKU	6993	-	-
150 hp - Z150TXR		06-10	0,60	BKR6EKU	6993	-	-
175 hp - 175A V6 2 temps 2596cc	6	83-08	1,00	B8HS-10	5126	-	-
175 hp - 175B V6 2 temps 2596cc	6	90-95	1,00	B8HS-10	5126	-	-
175 hp - 175C V6 2 temps 2596cc	6	91-95	1,00	B8HS-10	5126	-	-
175 hp - 175D V6 2 temps 2596cc	6	96-06	1,00	BR8HS-10	1134	-	-
175 hp - 175F V6 2 temps 2596cc	6	96-05	1,00	BR8HS-10	1134	-	-
175 hp - P175 / S175 / T175 V6 - 2.6L	6	94-99	1,00	BR8HS-10	1134	-	-
175 hp - S175D V6 2 temps 2596cc	6	97-	1,00	BR8HS-10	1134	-	-
175 hp - V6 - 2.6L	6	84-00	1,00	BR8HS-10	1134	-	-
175 hp - V175 V6 - 2.6L	6	00-	1,00	BR8HS-10	1134	-	-



Modèle

Cyl.







N° STOCK



N° STOCK IX

175 hp - VZ175 HPDI		02-05	0,60	BKR7EKU	5881	-	-
175 hp - VZ175TL HPDI (800105-> 800201)		01-	1,10	BKR7ES-11	2387	BKR7EIX-11	6988
175 hp - VZ175TL HPDI (800202->)		01-	0,60	BKR7EKU	5881	-	-
175 hp - VZ175TLR		06-10	0,60	BKR7EKU	5881	-	-
175 hp - Z175HPDI		02-05	0,60	BKR7EKU	5881	-	-
175 hp - Z175G V6 DFI 2 temps 2596cc		00-	0,60	BKR7EKU	5881	-	-
175 hp - Z175H 2 temps 2596cc		01-	0,60	BKR7EKU	5881	-	-
175 hp - Z175TX HPDI (800101->800231)		01-	1,10	BKR7ES-11	2387	BKR7EIX-11	6988
175 hp - Z175TX HPDI (800232->)		01-	0,60	BKR7EKU	5881	-	-
175 hp - Z175TXR		06-10	0,60	BKR7EKU	5881	-	-
200 hp - 200 / L200 / S200V6 - 2.6L	6	84-99	1,00	BR8HS-10	1134	-	-
200 hp - 200A 2 temps 2596cc	6	83-	1,00	B8HS-10	5126	-	-
200 hp - 200B 2 temps 2596cc	6	90-95	1,00	B8HS-10	5126	-	-
200 hp - 200C 2 temps 2596cc	6	91-95	1,00	B8HS-10	5126	-	-
200 hp - 200F / 200G 2 temps 2596cc	6	96-	1,00	BR8HS-10	1134	-	-
200 hp - 200H 2 temps 2596cc	6	98-05	1,00	BR8HS-10	1134	-	-
200 hp - 200J 2 temps 2596cc	6	00-05	1,00	BR8HS-10	1134	-	-
200 hp - 200TJR V6 - 2.6L	6	87-95	1,00	BR8HS-10	1134	-	-
200 hp - F200 4 temps		02-05	1,10	LFR5A-11	6376	LFR5AIX-11	4469
200 hp - F200A V6 4 temps 3352cc	6	02-	1,10	LFR5A-11	6376	LFR5AIX-11	4469
200 hp - F200B V6 4 temps 3352cc	6	07-	1,10	LFR5A-11	6376	LFR5AIX-11	4469
200 hp - F200C V6 4 temps 3352cc	6	07-	1,10	LFR6A-11	3672	LFR6AIX-11	6619
200 hp - F200D V6 MPFI 4 temps 4169cc	6	10-	1,10	LFR6A-11	3672	LFR6AIX-11	6619
200 hp - F200TXR		06-10	1,10	LFR5A-11	6376	LFR5AIX-11	4469
200 hp - FL200A V6 EFI 3352cc 4 temps	6	02-	1,10	LFR5A-11	6376	LFR5AIX-11	4469
200 hp - FL200B V6 EFI 3352cc 4 temps	6	07-	1,10	LFR5A-11	6376	LFR5AIX-11	4469
200 hp - FL200C V6 EFI 3352cc 4 temps	6	07-	1,10	LFR6A-11	3672	LFR6AIX-11	6619
200 hp - L200A V6 2 temps 2596cc	6	83-	1,00	B8HS-10	5126	-	-
200 hp - L200B V6 2 temps 2596cc	6	90-95	1,00	B8HS-10	5126	-	-
200 hp - L200F V6 2 temps 2596cc	6	96-	1,00	BR8HS-10	1134	-	-
200 hp - L200J V6 2 temps 2596cc	6	00-05	1,00	BR8HS-10	1134	-	-
200 hp - LF200		02-05	1,10	LFR5A-11	6376	LFR5AIX-11	4469
200 hp - LF200TXR		06-10	1,10	LFR5A-11	6376	LFR5AIX-11	4469
200 hp - LX200 V6 - 2.6L	6	99-01	1,00	BR8HS-10	1134	-	-
200 hp - LZ200		02-05	0,60	BKR7EKU	5881	-	-
200 hp - LZ200N V6 DFI 2 temps 2596cc	6	00-	0,60	BKR7EKU	5881	-	-
200 hp - LZ200TX HPDI (2000->100874)		00-01	1,10	BKR7ES-11	2387	BKR7EIX-11	6988
200 hp - LZ200TX HPDI (100875->)		01-	0,60	BKR7EKU	5881	-	-
200 hp - LZ200TXR		06-10	0,60	BKR7EKU	5881	-	-
200 hp - P200 V6 - 2.6L	6	91-95	1,00	BR9HS-10	4551	-	-
200 hp - P200 V6 - 2.6L	6	96-99	1,00	BR8HS-10	1134	-	-
200 hp - S200F / SL200F V6 2 temps 2596cc	6	97-03	1,00	BR8HS-10	1134	-	-
200 hp - SX200 V6 - 2.6L	6	99-05	1,00	BR8HS-10	1134	-	-
200 hp - V200 V760 EFI V6 - 2.6L	6	98-99	1,00	BR8HS-10	1134	-	-
200 hp - VX200 V6 - 3.1L	6	00-05	1,00	BR8HS-10	1134	-	-
200 hp - VX200D V6 - 3.3L	6	05-	1,00	BR8HS-10	1134	-	-
200 hp - VZ200 V6 - 2.6L	6	00-04	0,60	BKR7EKU	5881	-	-
200 hp - VZ200 V6 - 3.3L	6	05-	0,60	BKR6EKU	6993	-	-
200 hp - VZ200RTL R, TLR		06-10	0,60	BKR6EKU	6993	-	-
200 hp - Z200		02-05	0,60	BKR7EKU	5881	-	-
200 hp - Z200N V6 DFI 2 temps 2596cc	6	00-	0,60	BKR7EKU	5881	-	-
200 hp - Z200P V6 2 temps 2596cc	6	01-	0,60	BKR7EKU	5881	-	-
200 hp - Z200Q V6 2 temps 2596cc	6	05-07	0,60	BKR7EKU	5881	-	-
200 hp - Z200R V6 2 temps 3342cc	6	05-	0,60	BKR6EKU	6993	-	-
200 hp - Z200TL HPDI (2000->150689)		00-01	1,10	BKR7ES-11	2387	BKR7EIX-11	6988
200 hp - Z200TL HPDI (150690->)		01-	0,60	BKR7EKU	5881	-	-
200 hp - Z200TLR, TXR		06-10	0,60	BKR7EKU	5881	-	-
200 hp - Z200TX HPDI (2000->102420)		00-01	1,10	BKR7ES-11	2387	BKR7EIX-11	6988
200 hp - Z200TX HPDI (102421->)		01-	0,60	BKR7EKU	5881	-	-
220 hp - 220 V6 Special	6	84-86	1,00	BR8HS-10	1134	-	-
225 hp - 225 / Excel Resistor Required V6 - 2.6L	6	87-95	1,00	BR9HS-10	4551	-	-
225 hp - 225B 2 temps 2596cc		-95	1,00	BR9HS-10	4551	-	-
225 hp - 225C 2 temps 3130cc		94-04	1,00	BR9HS-10	4551	-	-
225 hp - 225D 2 temps 2596cc		96-	1,00	BR8HS-10	1134	-	-
225 hp - 225F V6 EFI 2 temps 3130cc		97-06	1,00	BR9HS-10	4551	-	-
225 hp - 225G 2 temps 3130cc		98-04	1,00	BR9HS-10	4551	-	-
225 hp - 225L 20" Shaft Only V6 - 2.6L	6	94-98	1,00	BR8HS-10	1134	-	-
225 hp - 225X V6 - 3.1L	6	94-99	1,00	BR9HS-10	4551	-	-
225 hp - F225		02-05	1,10	LFR5A-11	6376	LFR5AIX-11	4469
225 hp - F225A V6 EFI 4 temps 3352cc	6	02-10	1,10	LFR5A-11	6376	LFR5AIX-11	4469
225 hp - F225B V6 EFI 4 temps 3352cc	6	07-	1,10	LFR6A-11	3672	LFR6AIX-11	6619
225 hp - F225C V6 EFI 4 temps 3352cc	6	08-	1,10	LFR6A-11	3672	LFR6AIX-11	6619
225 hp - F225D MPFI / F225F EFI V6 4 temps 4169cc	6	10-	1,10	LFR6A-11	3672	LFR6AIX-11	6619
225 hp - F225TLR		06-10	1,10	LFR6A-11	3672	LFR6AIX-11	6619
225 hp - F225TUR, TXR		06-10	1,10	LFR5A-11	6376	LFR5AIX-11	4469
225 hp - FL225A V6 EFI 4 temps 3352cc	6	02-10	1,10	LFR5A-11	6376	LFR5AIX-11	4469
225 hp - FL225B V6 4 temps 3352cc	6	07-	1,10	LFR6A-11	3672	LFR6AIX-11	6619

 Modèle	Cyl.				N° STOCK		N° STOCK IX
225 hp - FL225F V6 EFI 4 temps 4169cc	6	10-	1,10	LF6A-11	3672	LF6AIX-11	6619
225 hp - L225		94-95	1,00	BR8HS-10	1134	-	-
225 hp - L225 V6 - 3.1L	6	94-99	1,00	BR9HS-10	4551	-	-
225 hp - L225C V6 2 temps 3130cc	6	94-04	1,00	BR9HS-10	4551	-	-
225 hp - L225F V6 EFI 2 temps 3130cc	6	97-06	1,00	BR9HS-10	4551	-	-
225 hp - LF225		02-05	1,10	LF5A-11	6376	LF5AIX-11	4469
225 hp - LF225TUR, TXR		06-10	1,10	LF5A-11	6376	LF5AIX-11	4469
225 hp - LX225		02-03	1,10	LF5A-11	6376	LF5AIX-11	4469
225 hp - LX225 / SX225 V6 - 3.1L	6	97-02	1,00	BR9HS-10	4551	-	-
225 hp - S225 V6 - 3.1L	6	94-99	1,00	BR9HS-10	4551	-	-
225 hp - V225 V760 EFI V6 - 3.1L	6	97-01	1,00	BR9HS-10	4551	-	-
225 hp - VX225 V760 EFI V6 - 3.1L	6	97-04	1,00	BR9HS-10	4551	-	-
225 hp - VZ225		03-04	0,60	BKR6EKU	6993	-	-
225 hp - VZ225HTLR, TLR		06-10	0,60	BKR6EKU	6993	-	-
225 hp - Z225H 2 temps 3342cc		04-	0,60	BKR6EKU	6993	-	-
250 hp - 250 / L250 V6 - 3.1L	6	90-95	1,00	BR8HS-10	1134	-	-
250 hp - 250A V6 2 temps 3130cc	6	90-96	1,00	BR8HS-10	1134	-	-
250 hp - 250B V6 EFI 2 temps 3130cc	6	97-06	1,00	BR9HS-10	4551	-	-
250 hp - 250C V6 2 temps 3130cc	6	03-04	1,00	BR9HS-10	4551	-	-
250 hp - 250G V6 2 temps 3130cc	6	06-	1,00	BR8HS-10	1134	-	-
250 hp - F250		05-	1,10	LF5A-11	6376	LF5AIX-11	4469
250 hp - F250A V6 EFI 4 temps 3352cc	6	05-	1,10	LF6A-11	3672	LF6AIX-11	6619
250 hp - F250B V6 EFI 4 temps 3352cc	6	08-10	1,10	LF6A-11	3672	LF6AIX-11	6619
250 hp - F250BTUR, BTRX		06-10	1,10	LF6A-11	3672	LF6AIX-11	6619
250 hp - F250C / F250D V6 EFI 4 temps 4169cc	6	10-	1,10	LF6A-11	3672	LF6AIX-11	6619
250 hp - F250G V6 EFI 4 temps 3352cc	6	12-	1,10	LF6A-11	3672	LF6AIX-11	6619
250 hp - F250TUR, TXR		06-10	1,10	LF6A-11	3672	LF6AIX-11	6619
250 hp - FL250A V6 EFI 4 temps 3352cc	6	05-	1,10	LF6A-11	3672	LF6AIX-11	6619
250 hp - FL250B V6 EFI 4 temps 3352cc	6	08-10	1,10	LF6A-11	3672	LF6AIX-11	6619
250 hp - FL250D V6 EFI 4 temps 4169cc	6	10-	1,10	LF6A-11	3672	LF6AIX-11	6619
250 hp - FL250G V6 EFI 4 temps 3352cc	6	12-	1,10	LF6A-11	3672	LF6AIX-11	6619
250 hp - L250 / S250 V6 - 3.1L	6	97-99	1,00	BR9HS-10	4551	-	-
250 hp - L250A V6 3130cc 2 temps	6	90-06	1,00	BR8HS-10	1134	-	-
250 hp - L250B V6 EFI 3130cc 2 temps	6	97-06	1,00	BR9HS-10	4551	-	-
250 hp - L250G V6 3130cc 2 temps	6	06-	1,00	BR8HS-10	1134	-	-
250 hp - LF250BTUR, BTRX, TUR, TXR		06-10	1,10	LF6A-11	3672	LF6AIX-11	6619
250 hp - LF250		05-	1,10	LF5A-11	6376	LF5AIX-11	4469
250 hp - LX250 V6 - 3.1L	6	97-03	1,00	BR9HS-10	4551	-	-
250 hp - LZ250 / Z250 3.3L		03-05	0,60	BKR6EKU	6993	-	-
250 hp - LZ250D V6 DFI 2 temps 3342cc	6	02-07	0,60	BKR6EKU	6993	-	-
250 hp - LZ250TUR, TXR		06-10	0,60	BKR6EKU	6993	-	-
250 hp - S250 V6 - 3.1L	6	90-96	1,00	BR8HS-10	1134	-	-
250 hp - SL250A 2 temps 3130cc		97-06	1,00	BR9HS-10	4551	-	-
250 hp - SX250 V6 - 3.1L	6	97-03	1,00	BR9HS-10	4551	-	-
250 hp - VX250 V6 - 3.1L	6	02-04	1,00	BR9HS-10	4551	-	-
250 hp - VZ250		03-05	0,60	BKR6EKU	6993	-	-
250 hp - VZ250 FTLR / TLR, Z250 TUR / TXR		06-10	0,60	BKR6EKU	6993	-	-
300 hp - F300A V8 MPFI 4 temps 5330cc	8	08-	1,10	LF6A-11	3672	LF6AIX-11	6619
300 hp - F300B V6 EFI 4 temps 4169cc	6	10-	1,10	LF6A-11	3672	LF6AIX-11	6619
300 hp - F300TUR, TXR		06-10	1,10	LF6A-11	3672	LF6AIX-11	6619
300 hp - FL300A V8 MPFI 4 temps 5330cc	8	08-	1,10	LF6A-11	3672	LF6AIX-11	6619
300 hp - FL300B V6 EFI 4 temps 4169cc	6	10-	1,10	LF6A-11	3672	LF6AIX-11	6619
300 hp - LF300TUR, TXR		06-10	1,10	LF6A-11	3672	LF6AIX-11	6619
300 hp - LX300 / Z300 3.3L		04-05	0,60	BKR6EKU	6993	-	-
300 hp - LZ300A V6 DFI 2 temps 3342cc		03-08	0,60	BKR6EKU	6993	-	-
300 hp - LZ300TUR, TXR		06-10	0,60	BKR6EKU	6993	-	-
300 hp - VZ300		04-05	0,60	BKR6EKU	6993	-	-
300 hp - VZ300BTLR, LTR		06-10	0,60	BKR6EKU	6993	-	-
300 hp - Z300B 2 temps 3342cc		03-	0,60	BKR6EKU	6993	-	-
300 hp - Z300TUR, Z300TUR		06-10	0,60	BKR6EKU	6993	-	-
350 hp - F350A V8 EFI 4 temps 5330cc	8	07-	1,10	LF6A-11	3672	LF6AIX-11	6619
350 hp - F350TUR, TXR		06-10	1,10	LF6A-11	3672	LF6AIX-11	6619
350 hp - FL350A V8 EFI 4 temps 5330cc	8	08-	1,10	LF6A-11	3672	LF6AIX-11	6619
350 hp - LF350TUR, TXR		06-10	1,10	LF6A-11	3672	LF6AIX-11	6619

YAMATO

35 / 350	-	0,50	B6HS	4510	BR6HIX	3419
----------	---	------	------	------	--------	------

ZÜNDAPP

5 hp, 5 / 6 PS, type 304, Delphin	-	0,50	B6HS	4510	BR6HIX	3419
-----------------------------------	---	------	------	------	--------	------



BOUGIES D'ALLUMAGE







Motonautisme

Cyl.	Nb Cyl.	Type	Modèle	0201			N° STOCK	N° BL	IX	N° STOCK IX
AQUABUG										
120	1		Aquabug 120 1.2HP	-	0,80	BP5S	3011	-	-	-
175	1		Superbug 175 1.75HP	-	0,80	BP5S	3011	-	-	-
300	1		Superbug 300 3.0HP	-	0,80	BP5S	3011	-	-	-
AQUA-JET (Jet Bike)										
432			Solution SX1	-	0,80	B7ES	1111	-	BR7EIX	6664
1250			WX-1 1250 R	01-03	0,60	BR8ES	5422	05	BR8EIX	5044
AQUASCOOTER										
48	1		moteur ILO	-	0,80	B5HS	4210	-	-	-
ARCTO / TIGERSHARK - Motomarine										
640	2		Barracuda	94-95	0,70	BR9ES	5722	02	BR9EIX	3981
640	2		Daytona	93-95	0,70	BR9ES	5722	02	BR9EIX	3981
640	2		Monte Carlo / Montego / Deluxe	94-96	0,70	BR9ES	5722	02	BR9EIX	3981
640	2		Monte Carlo / Montego / Deluxe	97	0,70	BR9EYA	7548	-	BR9EIX	3981
640	2	TS	Tigershark	93	0,70	BR9ES	5722	02	BR9EIX	3981
640	2	TS	TS 640, TS-L640	98-99	0,70	BR9EYA	7548	-	BR9EIX	3981
770	2		Daytona 770, Monte Carlo 770 Blue & Red	96	0,70	BR9ES	5722	02	BR9EIX	3981
770	2		Daytona 770, Monte Carlo 770	97	0,70	BR9EYA	7548	-	BR9EIX	3981
770	2	TS	TS-770, TS-L770, TS-R770	98-99	0,70	BR9EYA	7548	-	BR9EIX	3981
900	3		Monte Carlo 900	96-	0,70	BR9ES	5722	02	BR9EIX	3981
900	3	TS	Tigershark	95	0,70	BR9ES	5722	02	BR9EIX	3981
900	3	TS	TS-900L	99	0,70	BR9ES	5722	02	BR9EIX	3981
1000	3		Daytona 1000, Monte Carlo 1000	97	0,70	BR9EYA	7548	-	BR9EIX	3981
1000	3	TS	TS-L1000 / TS-R1000	98	0,70	BR9EYA	7548	-	BR9EIX	3981
1100	3	TS	TS-1100R	99	0,70	BR9EYA	7548	-	BR9EIX	3981
1100	3	TS	TS-1100Li	99	0,70	PZFR6H	7696	-	-	-
BOMBARDIER voir SEA-DOO										
DOLPHIN										
-			Mark 7 Auxiliary 12HP	-	0,60	B6ES	7310	-	-	-
FUN BOATS										
-			Pump´r 60HP	-	1,00	B7HS	5110	03	BR7HIX	7067
HONDA - Motomarine										
1200	4	ARX	Aqua Trax R-12 (ARX1200N2 A)	04-06	0,90	IMR9D-9H	6544	-	-	-
1200	4	ARX	Aqua Trax F-12 (ARX1200N3 A) 125hp	02-07	0,90	IMR9D-9H	6544	-	-	-
1200	4	ARX	Aqua Trax R-12X (ARX1200T2 A) 165 hp	03-07	0,90	IMR9D-9H	6544	-	-	-
1200	4	ARX	Aqua Trax F-12X (ARX1200T3 A) 165hp	02-07	0,90	IMR9D-9H	6544	-	-	-
1200	4	ARX	Aqua Trax F-12X GPS (ARX1200T3D A) 165hp	05-07	0,90	IMR9D-9H	6544	-	-	-
1500	4	ARX	Aqua Trax F-15 (ARX1500N3 A)	09	0,90	IMR9D-9H	6544	-	-	-
1500	4	ARX	Aqua Trax F-15X (ARX1500T3 A) 200hp	08-09	0,90	IMR9D-9H	6544	-	-	-
1500	4	ARX	Aqua Trax F-15X GPS (ARX1500T3D 2A) 200hp	08-09	0,90	IMR9D-9H	6544	-	-	-

Cyl.	Nb Cyl.	Type	Modèle				N° STOCK	N° BL		N° STOCK IX
HOVERCRAFT										
250			EC25PS	-	0,70	BR9ES	3194	02	BR9EIX	3981
440			EC25-PS, EC44-2PM / PM, EC50-2PM	-	0,80	BR9ES	3194	02	BR9EIX	3981
500			EC50PM	-	0,70	BR9ES	3194	02	BR9EIX	3981
HYDRO-DISC										
-			50 HP	-	0,80	B9ES	2611	02	BR9EIX	3981
JET BREEZE										
-			Hurricane 50 HP	-	0,80	B9ES	2611	02	BR9EIX	3981
JET STAR 1250										
-			Moteur Suzuki	-	0,80	B6HS	4510	09	BR6HIX	3419
KAWASAKI - Motomarine										
300	1	SX	300 SX (JS300-A1~2)	87-88	0,80	B7ES	1111	-	BR7EIX	6664
300	1	SX	300 SX (JS300-A3~5)	89-91	0,80	BR7ES	5122	-	BR7EIX	6664
440	2	JS	JS440 (JS440-A3~12)	79-92	0,80	B7ES	1111	-	BR7EIX	6664
440	2	JS	JS440 (JS440-A13)	89	0,80	BR7ES	5122	-	BR7EIX	6664
440	2	JS	JS440 (JS440-A14)	90-92	0,80	BR7ES	5122	-	BR7EIX	6664
440	2	JS	JS440 (JS440-A15~16)	91-92	0,80	BR7ES	5122	-	BR7EIX	6664
440		SX		76-92	0,80	BR7ES	5122	-	BR7EIX	6664
550	2	JS	JS550 (JS550-A5~7)	86-88	0,80	B8ES	2411	05	BR8EIX	5044
550	2	JS	JS550 (JS550-A8)	89	0,80	BR8ES	5422	05	BR8EIX	5044
550	2	SX	550 SX (JS550-B1), 550 SX (JS550-C1~5)	90-91	0,80	BR8ES	5422	05	BR8EIX	5044
650	2	JB	Jet Mate (JB650A1~2), Jet Mate (JB650A3~4)	89-92	0,80	BR7ES	5122	-	BR7EIX	6664
650	2	JF	X2 (JF650-A1~3)	86-88	0,80	B7ES	1111	-	BR7EIX	6664
650	2	JF	X2 (JF650-A4~10)	89-95	0,80	BR7ES	5122	-	BR7EIX	6664
650	2	JF	TS (JF650-B1~8)	89-96	0,80	BR7ES	5122	-	BR7EIX	6664
650	2	JL	SC (JL650-A1~5)	91-95	0,80	BR7ES	5122	-	BR7EIX	6664
650	2	SX	650 SX (JS650-A1~2)	87-88	0,80	B7ES	1111	-	BR7EIX	6664
650	2	SX	650 SX (JS650-A3~4), 650 SX (JS650-B1~3)	89-93	0,80	BR7ES	5122	-	BR7EIX	6664
750	2	JH	Super Sport (JH750-A1~4), Super Sport XI (JH750-B1~3)	92-95	0,80	BR8ES	5422	05	BR8EIX	5044
750	2	JH	750 ZXi (JH750-C1~3)	95-97	0,80	BR8ES	5422	05	BR8EIX	5044
750	2	JH	750 XIR (JH750-D1)	94	0,80	BR8ES	5422	05	BR8EIX	5044
750	2	JH	Super Sport (JH750-E1~2), Super Sport XI (JH750-F1)	96-97	0,80	BR8ES	5422	05	BR8EIX	5044
750	2	JH	Xi Sport (JH750-G1)	98-99	0,80	BR8ES	5422	05	BR8EIX	5044
750	2	SX	750 SX (JS750-A1~4)	92-95	0,80	BR8ES	5422	05	BR8EIX	5044
750	2	JS	SXi (JS750-B1~3), SXi PRO (JS750-C1~5)	95-02	0,80	BR8ES	5422	05	BR8EIX	5044
750	2	STX	ST (JT750-A1 / A1A / A2)	94-95	0,80	BR8ES	5422	05	BR8EIX	5044
750	2	STX	STX (JT750-B1~3), STS (JT750-C1)	95-98	0,80	BR8ES	5422	05	BR8EIX	5044
800	2	SX	SX-R (JS800-A1~3, 6F, 7F, 8F, 9F, AF, BF)	03-11	0,80	BR8ES	5422	05	BR8EIX	5044
900	3	JH	900 ZXi (JH900-A1~3)	95-97	0,80	BR9ES	5722	02	BR9EIX	3981
900	3	STX	STX (JT900-A1~2 / B1~2), STS (JT900-B3~4 / C1~2)	97-02	0,80	BR9ES	5722	02	BR9EIX	3981
900	3	STX	STX (JT900-D1), STX (JT900-E1~2 / E6F)	03-06	0,80	BR9ES	5722	02	BR9EIX	3981
1100	3	JH	Ultra 130 (JH1100-B1~4)	01-04	0,80	PZFR7G-G	4253	-	-	-
1100	3	JH	1100 ZXi (JH1100-A1~8)	96-03	0,80	BR9ES	5722	02	BR9EIX	3981
1100	3	STX	1100 STX (JT1100-A1 / B1~2)	97-99	0,80	BR9ES	5722	02	BR9EIX	3981
1100	3	STX	1100 STX D.I. (JT1100-C1/F1~2/G1)	00-03	0,80	PZFR7G-G	4253	-	-	-
1200	3	JH	Ultra 150 (JH1200-A1)	99	0,60	R6918C-9	5196	-	-	-
1200	3	JH	Ultra 150 (JH1200-A2~4)	00-05	0,80	BR9ES	5722	02	BR9EIX	3981
1200	3	JH	Ultra 150 (JH1200-B1~3)	03-05	0,80	BR9ES	5722	02	BR9EIX	3981
1200	3	STX	1200 STX-R (JT1200-A1~2 / C1~2)	02-05	0,80	BR9ES	5722	02	BR9EIX	3981
1200	3	STX	STX-12F (JT1200-B1~2 / D1 / D6F / D7F)	03-07	0,60	CR9EK	4548	-	CR9EIX	3521
1500	4	JT	Ultra 250X (JT1500B7F, 8F)	07-08	0,70	PMR9B	4717	-	-	-

KAWASAKI

Cyl.	Nb Cyl.	Type	 Modèle				N° STOCK	N° BL		N° STOCK IX
1500	4	JT	Ultra LX (JT1500C7F, 8F)	07-08	0,80	CR9EK	4548	-	CR9EIX	3521
1500	4	JT	Ultra 260X (JT1500E9F, AF), Ultra 260LX (JT1500F9F, AF)	09-10	0,70	PMR9B	4717	-	-	-
1500	4	JT	Ultra LX (JT1500G9F, AF, BF)	09-11	0,80	CR9EK	4548	-	CR9EIX	3521
1500	4	JT	Ultra 300X (JT1500HBF, CF, DF)	11-13	0,70	PMR9B	4717	-	-	-
1500	4	JT	Ultra 300X (JT1500HBF, CFA)	11-12	0,70	PMR9B	4717	-	-	-
1500	4	JT	Ultra 300LX (JT1500JBF, CF, DF)	11-13	0,70	PMR9B	4717	-	-	-
1500	4	JT	Ultra LX (JT1500KFF / KGF / KHF)	15-17	0,80	CR9EK	4548	-	CR9EIX	3521
1500	4	JT	Ultra 310X (JT1500LEF / LFF / PFF / LGF / PGF / LHF / PHF)	14-17	0,70	PMR9B	4717	-	-	-
1500	4	JT	Ultra 310LX (JT1500MEF / MFF / MGF / MHF)	14-17	0,70	PMR9B	4717	-	-	-
1500	4	JT	Ultra 310R (JT1500NEF / NFF / NGF / NHF)	14-17	0,70	PMR9B	4717	-	-	-
1500	4	JT	Ultra 310X SE (JT1500PEF)	14	0,70	PMR9B	4717	-	-	-
1500	4	JT	Ultra LX (JT1500KCF, DF, EF)	12-14	0,80	CR9EK	4548	-	CR9EIX	3521
1500	4	STX	STX (JT1500D9F, AF)	09-10	0,80	CR9EK	4548	-	CR9EIX	3521
1500	4	STX	STX-15F (JT1500-A1~2, 6F, 7F, 8F, 9F, AF, BF, CF, DF, EF)	04-14	0,80	CR9EK	4548	-	CR9EIX	3521
1500	4	STX	STX-15F (JT1500AFF AGF / AHF)	15-17	0,80	CR9EK	4548	-	CR9EIX	3521

MASTERCRAFT (Wet-Jet)





300		Duo 300	95-97	0,60	BR8HS	4322	01	BR8HIX	7001
428		428	85-87	0,80	BR8ES	5422	05	BR8EIX	5044
432		432 Brut	88-92	0,70	BR8ES	5422	05	BR8EIX	5044
432		Duo 200	94-	0,80	BR8ES	5422	05	BR8EIX	5044
432		Special Edition	91-92	0,70	BR8ES	5422	05	BR8EIX	5044
432		Sport	90-93	0,70	BR8ES	5422	05	BR8EIX	5044
700		Duo / Duo 300, Kraze	95-97	0,60	BR8HS	4322	01	BR8HIX	7001
700	ZX		95-97	0,60	BR8HS	4322	01	BR8HIX	7001

NAUTICA - Motomarine

-		Mercury 90 / 120 ch	-	1,00	BZ7HS-10	3579	-	-	-
---	--	---------------------	---	------	----------	------	---	---	---

POLARIS - Motomarine

650	3	SL	68 hp - Moteur EC65 PWX	92-93	0,70	BPR7ES	2023	-	BPR7EIX	4055
650	3	SL	68 hp - Moteur EC65 PW-02	94-95	0,70	BPR7ES	2023	-	BPR7EIX	4055
650	3	SL	STD - 68 hp - Moteur EC65 PW-02	95	0,70	BPR7ES	2023	-	BPR7EIX	4055
700	2	Freedom	Freedom & INT'L Freedom	02-04	0,70	BPR8ES	3923	-	BPR8EIX	6684
700	2	Hurricane	Hurricane & INT'L Hurricane - Mot. WC70DCSP-03 / 04 - 95 ch	96-97	0,70	BPR8ES	3923	-	BPR8EIX	6684
700	2	SL	SL & INT'L SL - 80 ch	96	0,70	BPR7ES	2023	-	BPR7EIX	4055
700	2	SL	SL & INT'L SL - Moteur WC70DCSP-01 - 80 ch	97	0,70	BPR8ES	3923	-	BPR8EIX	6684
700	2	SL	SL Deluxe & INT'L SL Deluxe - 85 hp	97	0,70	BPR7ES	2023	-	BPR7EIX	4055
700	2	SLT	SLT & INT'L SLT - 80 ch	96-99	0,70	BPR7ES	2023	-	BPR7EIX	4055
700	2	SLH	SLH & INT'L SLH - Moteur W70-99 DCSP-01A2	98-01	0,70	BPR8ES	3923	-	BPR8EIX	6684
700	2	SLTH	SLTH & INT'L SLTH - W70-99 DCSP-01A1	98-99	0,70	BPR8ES	3923	-	BPR8EIX	6684
700	2	Virage	VIRAGE & INT'L VIRAGE - Moteur W70-SCSP	00-04	0,70	BPR8ES	3923	-	BPR8EIX	6684
750	2	MSX	MSX 110 / MSX 150	04-	0,70	BKR7E	6097	-	BKR7EIX	2667
750	3	SL	78 hp - Moteur EC75-PW-01	93	0,70	BPR7ES	2023	-	BPR7EIX	4055
750	3	SL / SLT	80 hp - Moteur EC75-PW-02	94-95	0,70	BPR7ES	2023	-	BPR7EIX	4055
777	2	Octane	Octane	02-04	0,70	BR9ES	5722	02	BR9EIX	3981
777	2	Virage	Virage I & INT'L Virage I	02-04	0,70	PZFR6H	7696	-	-	-
780	3	SL	EC78PWE-02 - 90 ch	96	0,70	BPR8ES	3923	-	BPR8EIX	6684
780	3	SL	SL & INT'L SL - Moteur EC78PWE-02 - 95 ch	97	0,70	BPR8ES	3923	-	BPR8EIX	6684
780	3	SLT	SLT & INT'L SLT - Moteur EC78PWE-02 - 90 ch	96	0,70	BPR8ES	3923	-	BPR8EIX	6684
780	3	SLT	Moteur EC78PWE-02 - 95 ch	97	0,70	BPR8ES	3923	-	BPR8EIX	6684
780	3	SLX	SLX & INT'L SLX - Moteur EC78PWE-02	95-96	0,70	BPR8ES	3923	-	BPR8EIX	6684
785	3	SLX	SL PRO & INT'L SL PRO - Moteur EC78PWE-01	97-00	0,70	BR9ES	5722	02	BR9EIX	3981
900	3	SL	SL & INT'L SL - Moteur WC90TCSP-01 - 100 ch	96	0,70	BPR8ES	3923	-	BPR8EIX	6684
900	3	SL	110 ch	97	0,70	BPR8ES	3923	-	BPR8EIX	6684
1050	3	SL	WC105TCSP-02 - 120 ch	97	0,70	BPR8ES	3923	-	BPR8EIX	6684
1050	3	SLTX	SLTX & INT'L SLTX - Moteur W105-99 TCSP-05	96-98	0,70	BPR8ES	3923	-	BPR8EIX	6684
1050	3	SLTX	SLTX & INT'L SLTX	99	0,70	BPR8ES	3923	-	BPR8EIX	6684
1050	3	SLXH	SLXH	98	0,70	BPR8ES	3923	-	BPR8EIX	6684
1050	3	SLX	SLX & INT'L SLX - Moteur W105-99 TCSP-05	99-	0,70	BPR8ES	3923	-	BPR8EIX	6684
1200	3	Genesis	GENESIS & INT'L GENESIS - W120-TCSP-01A3/A4	99	0,70	BPR8ES	3923	-	BPR8EIX	6684
1200	3	Genesis	GENESIS & INT'L GENESIS - W120-TCSP-02A	00-02	0,70	BR9ES	5722	02	BR9EIX	3981
1200	3	Genesis	GENESIS FICHT & INT'L GENESIS FICHT	99	0,80	IZFR6N-E	4757	-	-	-
1200	3	Genesis	GENESIS & INT'L GENESIS FFI - Moteur W120-DFI-02A	00	0,80	PZFR6H	7696	-	-	-
1200	3	Genesis	GENESIS I & INT'L GENESIS I - W120-DFI-02A	00-04	0,80	PZFR6H	7696	-	-	-
1200	3	MSX	MSX 140	03-04	0,80	PZFR6H	7696	-	-	-
1200	3	PRO	PRO 1200 & INT'L PRO 1200 - Moteur W120-TCSP-02A	00-01	0,70	BR9ES	5722	02	BR9EIX	3981

Cyl.	Nb Cyl.	Type	Modèle				N° STOCK	N° BL		N° STOCK IX
1200	3	SLTX	SLTX-B	99	0,70	BPR8ES	3923	-	BPR8EIX	6684
1200	3	SLX	SLX & INT'L SLX - Moteur W120-TCSP-02A	00-01	0,70	BR9ES	5722	02	BR9EIX	3981
1200	3	Virage	VIRAGE TX & INT'L VIRAGE TX - W120-TCSP-02A	00-02	0,70	BR9ES	5722	02	BR9EIX	3981
1200	3	Virage	VIRAGE TXI & INT'L VIRAGE TXI - Moteur W120-DFH-02A	01-04	0,80	PZFR6H	7696	-	-	-
1200		X45		99-	0,70	BR9ES	5722	02	BR9EIX	3981
		Power Board		89-90	1,00	BPR7HS-10	1092	-	BPR7HIX	5944

PROGRESSIVE POWER

Formula Micro	87-90	0,60	BPM6A	7021	-	-	-
---------------	-------	------	-------	------	---	---	---

SEA-DOO / BOMBARDIER - Motomarine

550		Bullet 5599 / 6115 / 6162 / 6163	04-	0,80	DCPR8E	4339	-	DCPR8EIX	6546	
580	5801		88-	0,70	BR7ES	5122	-	BR7EIX	6664	
580	5802		89-	0,70	BR7ES	5122	-	BR7EIX	6664	
580	5803		90-	0,70	BR7ES	5122	-	BR7EIX	6664	
580	5810		90-	0,70	BR7ES	5122	-	BR7EIX	6664	
580	EXP		93-	0,60	BR7ES	5122	-	BR7EIX	6664	
580	GT		90-91	0,60	BR7ES	5122	-	BR7EIX	6664	
580	2	GTS	92-95	0,60	BR7ES	5122	-	BR7EIX	6664	
580	2	GTS	5817 - 60 hp	96	0,60	BR7ES	5122	-	BR7EIX	6664
580		GTX		92-93	0,60	BR7ES	5122	-	BR7EIX	6664
580	2	SP		88-95	0,60	BR7ES	5122	-	BR7EIX	6664
580	2	SP	5876 - 55 hp	96	0,60	BR7ES	5122	-	BR7EIX	6664
580	2	SPi		93-95	0,60	BR7ES	5122	-	BR7EIX	6664
580	2	SPi	5878 - 60 hp	96	0,60	BR7ES	5122	-	BR7EIX	6664
580		SPX		93-	0,60	BR7ES	5122	-	BR7EIX	6664
580		XP		91-93	0,60	BR7ES	5122	-	BR7EIX	6664
610		SP	Barracuda Premium 6157/6158	04-	0,60	BR8ES	5422	05	BR8EIX	5044
650		GTX/SPX		94-95	0,60	BR8ES	5422	05	BR8EIX	5044
650		XP		93-94	0,60	BR8ES	5422	05	BR8EIX	5044
720	2	GS	5518, 5519, 5548, 5621, 5626 - 85 hp	97-01	0,60	BR8ES	5422	05	BR8EIX	5044
720	2	GS	5644, 5827, 5844, 5846, 5847 - 85 hp	97-01	0,60	BR8ES	5422	05	BR8EIX	5044
720	2	GSi	5622 - 85 hp	97	0,60	BR8ES	5422	05	BR8EIX	5044
720	2	GTi	5865, 5866, 5641, 5836, 5841, 5884, 5885 - 85 hp	96-99	0,60	BR8ES	5422	05	BR8EIX	5044
720	2	GTi	5647, 5657, 5552, 5522, 5523, 5558, 5559, 6116 - 85 hp	00-02	0,60	BR8ES	5422	05	BR8EIX	5044
720	2	GTi	85 hp	03-05	0,60	BR8ES	5422	05	BR8EIX	5044
720	2	GTi	LE - 5560, 5561, 6117 - 85 hp	02	0,60	BR8ES	5422	05	BR8EIX	5044
720	2	GTi	LE - 85 hp	03-04	0,60	BR8ES	5422	05	BR8EIX	5044
720	2	GTi	LE RFI - 6103, 6104 - 110 hp	03	0,60	BR8ES	5422	05	BR8EIX	5044
720	2	GTS	5818, 5819, 5883, 5639, 5520, 5521, 5551 - 85 hp	97-01	0,60	BR8ES	5422	05	BR8EIX	5044
720	2	HX		95	0,60	BR8ES	5422	05	BR8EIX	5044
720	2	HX	5881, 5882 - 85 hp	96-97	0,60	BR8ES	5422	05	BR8EIX	5044
720	2	SP	5879 - 60 hp	97	0,60	BR8ES	5422	05	BR8EIX	5044
720	2	SPX	5877 - 85 hp	96	0,60	BR8ES	5422	05	BR8EIX	5044
720		XP		95-	0,60	BR8ES	5422	05	BR8EIX	5044
780	2	3D	RFI	04-05	0,60	BR8ES	5422	05	BR8EIX	5044
780	2	GSX	5620, 5624 - 110 hp	96-97	0,60	BR8ES	5422	05	BR8EIX	5044
780	2	GSX	RFI 5637, 5638, 5652, 5829, 5645, 5654, 5549 - 110 hp	99-01	0,60	BR8ES	5422	05	BR8EIX	5044
780	2	GTi	LE RFI - 110 hp	04-05	0,60	BR8ES	5422	05	BR8EIX	5044
780	2	GTi	RFI / RFI STD - 110 hp	04-05	0,60	BR8ES	5422	05	BR8EIX	5044
780	2	GTX	5640, 5642 - 110 hp	96-02	0,60	BR8ES	5422	05	BR8EIX	5044
780	2	GTX	RFI 5666, 5843, 5886, 5887 - 110 hp	98-99	0,60	BR8ES	5422	05	BR8EIX	5044
780	2	GTX	RFI 5648, 5648, 5515, 5516 - 110 hp	00	0,60	BR8ES	5422	05	BR8EIX	5044
780	2	GTX	RFI 5524, 5525, 5553, 5555, 5565, 5566 - 110 hp	01-02	0,60	BR8ES	5422	05	BR8EIX	5044
780	2	SPX	5834, 5661, 5838, 5839, 5636, 5828 - 110 hp	97-99	0,60	BR8ES	5422	05	BR8EIX	5044
780	2	XP		95	0,60	BR8ES	5422	05	BR8EIX	5044
780	2	XP	5858, 5859, 5662 - 110 hp	96-97	0,60	BR8ES	5422	05	BR8EIX	5044
900	2	Spark	Spark Ace 900 / HO	14-17	0,60	CR8EB	7784	-	CR8EIX	4218
950	2	3D	3D 947 Di	06-07	1,10	ZFR4F-11	4043	-	-	-
950	2	GSX	Limited 5625, 5629, 5845, 5848, 5849 - 130 hp	98-99	0,60	BR8ES	5422	05	BR8EIX	5044
950	2	GTX	Limited 5837, 5842, 5888, 5889 - 130 hp	98-99	0,60	BR8ES	5422	05	BR8EIX	5044
950	2	GTX	5653, 5669, 5544, 5545, 5526, 5527, 5538, 5539 - 130 hp	00-01	0,60	BR8ES	5422	05	BR8EIX	5044
950	2	GTX	5587, 5588 - 130 hp	02	0,60	BR8ES	5422	05	BR8EIX	5044
950	2	GTX	DI - 5649, 5659, 5528, 5529, 5540, 5541 - 130 hp	00-01	1,10	ZFR4F-11	4043	-	-	-
950	2	GTX	DI - 5563, 5564, 5595, 5596, 6118, 6119 - 130 hp	02-03	1,10	ZFR4F-11	4043	-	-	-
950	2	LRV	DI - 5460, 5771 - 130 hp	02-03	1,10	ZFR4F-11	4043	-	-	-
950	2	LRV	5688, 5697 - 130 hp	00-01	0,60	BR8ES	5422	05	BR8EIX	5044
950	2	RX	5513, 5514, 5532, 5533, 5542, 5543 - 130 hp	00-01	0,60	BR8ES	5422	05	BR8EIX	5044
950	2	RX	5579, 5580, 5581, 5582 - 130 hp	02	0,60	BR8ES	5422	05	BR8EIX	5044

SEA-DOO / BOMBARDIER

Cyl.	Nb Cyl.	Type	 Modèle				N° STOCK	N° BL		N° STOCK IX
950	2	RX	DI - 5646, 5656 - 130 hp	00	0,80	ZFR5F	5165	-	-	-
950	2	RX	DI - 5534, 5535, 5536, 5537 - 130 hp	01	1,10	ZFR4F-11	4043	-	-	-
950	2	RX	DI - 5586, 5591, 5592, 6122, 6123 - 130 hp	02-03	1,10	ZFR4F-11	4043	-	-	-
950	2	RX	DI (LE) - 5583, 5584, 5585 - 130 hp	02	1,10	ZFR4F-11	4043	-	-	-
950	2	RX	RXX - 5589 - 160 hp	01	0,60	BR8ES	5422	05	BR8EIX	5044
950	2	XP	5651, 5655, 5530, 5531, 5577, 5578 - 130 hp	00-02	0,60	BR8ES	5422	05	BR8EIX	5044
950	2	XP	Limited 5665, 5667, 5868, 5869 - 130 hp	98-99	0,60	BR8ES	5422	05	BR8EIX	5044
950	2	XP	DI - 6130, 6131 - 130 hp	03-	1,10	ZFR4F-11	4043	-	-	-
950	2	XP	DI - 130 hp	04	1,10	ZFR4F-11	4043	-	-	-
1500	3	GTX	4-Tec 5573, 5574, 5593, 5594 - 155 hp	03	0,70	DCPR8E	4339	-	DCPR8EIX	6546
1500	3	GTX	4-Tec - 155 hp	04-05	0,70	DCPR8E	4339	-	DCPR8EIX	6546
1500	3	GTX	4-Tec - 155 hp	08-14	0,70	DCPR8E	4339	-	DCPR8EIX	6546
1500	3	GTX	4-Tec LTD	06-07	0,70	DCPR8E	4339	-	DCPR8EIX	6546
1500	3	GTX	4-Tec LTD - 155 hp	11-14	0,70	DCPR8E	4339	-	DCPR8EIX	6546
1500	3	GTX	4-TEC LTD Supercharged	03-04	0,70	DCPR8E	4339	-	DCPR8EIX	6546
1500	3	GTX	4-TEC Supercharged	03-06	0,70	DCPR8E	4339	-	DCPR8EIX	6546
1500	3	GTX	4-TEC Special Supercharged	04	0,80	DCPR8E	4339	-	DCPR8EIX	6546
1500	3	GTX	4-TEC STD	05-06	0,80	DCPR8E	4339	-	DCPR8EIX	6546
1500	3	GTX	4-TEC LTD SCIC	05	0,80	DCPR8E	4339	-	DCPR8EIX	6546
1500	3	GTX	4-TEC Wake - 155cv	03-06	0,80	DCPR8E	4339	-	DCPR8EIX	6546
1500	3	GTX	215 Ch	08-13	0,80	DCPR8E	4339	-	DCPR8EIX	6546
1500	3	GTX	LTD 215 ch	08	0,80	DCPR8E	4339	-	DCPR8EIX	6546
1500	3	GTX	LTD iS 255 ch	09	0,80	DCPR8E	4339	-	DCPR8EIX	6546
1500	3	RXP	215 hp	04-09	0,80	DCPR8E	4339	-	DCPR8EIX	6546
1500	3	RXT	215 hp	05-10	0,80	DCPR8E	4339	-	DCPR8EIX	6546
1500	3	RXT	iS 260 hp	10-12	0,80	DCPR8E	4339	-	DCPR8EIX	6546
1500	3	GTi	4-Tec SE, STD, Rental	07	0,70	DCPR8E	4339	-	DCPR8EIX	6546
1500	3	GTi	GTi	15	0,80	DCPR8E	4339	-	DCPR8EIX	6546
1500	3	GTi	GTi 130	08-17	0,70	DCPR8E	4339	-	DCPR8EIX	6546
1500	3	GTi	GTi 155 / GTi 215	16-17	0,70	DCPR8E	4339	-	DCPR8EIX	6546
1500	3	GTi	GTi LTD 155	15	0,70	DCPR8E	4339	-	DCPR8EIX	6546
1500	3	GTi	Rental, SE, STD	06	0,70	DCPR8E	4339	-	DCPR8EIX	6546
1500	3	GTi	SE 130	08-14	0,70	DCPR8E	4339	-	DCPR8EIX	6546
1500	3	GTi	SE 155	08-15	0,70	DCPR8E	4339	-	DCPR8EIX	6546
1500	3	GTi	Rental 130	08-10	0,70	DCPR8E	4339	-	DCPR8EIX	6546
1500	3	GTR	GTR 130 / 155	16-17	0,70	DCPR8E	4339	-	DCPR8EIX	6546
1500	3	GTR	GTR 215	12-17	0,70	DCPR8E	4339	-	DCPR8EIX	6546
1500	3	GTS	GTS 130 & Rental	11-15	0,70	DCPR8E	4339	-	DCPR8EIX	6546
1500	3	GTS	Pro 130 ch	11	0,70	DCPR8E	4339	-	DCPR8EIX	6546
1500	3	GTS	GTS 130 / 155 / 215	16-17	0,70	DCPR8E	4339	-	DCPR8EIX	6546
1500	3	GTX	GTX 130	17	0,70	DCPR8E	4339	-	DCPR8EIX	6546
1500	3	GTX	GTX 155	15	0,70	DCPR8E	4339	-	DCPR8EIX	6546
1500	3	GTX	GTX 155 / 230 / 300	17	0,70	DCPR8E	4339	-	DCPR8EIX	6546
1500	3	GTX	GTX S 155	12-15	0,70	DCPR8E	4339	-	DCPR8EIX	6546
1500	3	GTX	iS 215 ch	10-11	0,80	DCPR8E	4339	-	DCPR8EIX	6546
1500	3	GTX	LTD 215 ch	14-15	0,80	DCPR8E	4339	-	DCPR8EIX	6546
1500	3	GTX	LTD iS 260 ch	10-15	0,80	DCPR8E	4339	-	DCPR8EIX	6546
1500	3	GTX	STD & Wake	07	0,80	DCPR8E	4339	-	DCPR8EIX	6546
1500	3	RXP	155 hp	07-08	0,80	DCPR8E	4339	-	DCPR8EIX	6546
1500	3	RXP	RXP-X / RS - 255 hp	08-11	0,80	DCPR8E	4339	-	DCPR8EIX	6546
1500	3	RXP	RXP-X 260 & RS - 260 hp	13-15	0,80	DCPR8E	4339	-	DCPR8EIX	6546
1500	3	RXT	iS 255 hp	09	0,80	DCPR8E	4339	-	DCPR8EIX	6546
1500	3	RXT	RXT-X 255 hp	08-09	0,80	DCPR8E	4339	-	DCPR8EIX	6546
1500	3	RXT	RXT-X 255 RS - 255 hp	09	0,80	DCPR8E	4339	-	DCPR8EIX	6546
1500	3	RXT	RXT 260 & RS / RXT-X AS 260 & RS - 260 hp	11-15	0,80	DCPR8E	4339	-	DCPR8EIX	6546
1500	3	RXT	RXT-X 260 & RS - 260 hp	10-15	0,80	DCPR8E	4339	-	DCPR8EIX	6546
1500	3	Wake	130	17	0,80	DCPR8E	4339	-	DCPR8EIX	6546
1500	3	Wake	155 hp	08-17	0,80	DCPR8E	4339	-	DCPR8EIX	6546
1500	3	Wake	215 hp	08	0,80	DCPR8E	4339	-	DCPR8EIX	6546
1500	3	Wake	PRO 215 hp	09-16	0,80	DCPR8E	4339	-	DCPR8EIX	6546
1500	3	Wake	PRO 230	17	0,80	DCPR8E	4339	-	DCPR8EIX	6546

SEAFLASH - Motomarine

-	Moteur Suzuki	-	0,80	B6HS	4510	09	BR6HIX	3419
---	---------------	---	------	------	------	----	--------	------

SKIDADDLE

-	Aquajet	-	0,80	BR7ES	5122	-	BR7EIX	6664
---	---------	---	------	-------	------	---	--------	------

Cyl.	Nb Cyl.	Type	Modèle	0201			N° STOCK	N° BL		N° STOCK IX
------	---------	------	--------	------	--	--	----------	-------	--	-------------

SKI-FREE

-	2	40 HP	-	0,60	BR8ES	5422	05	BR8EIX	5044
---	---	-------	---	------	-------	------	----	--------	------

SKI-WHEE

440	Ski Tow Kohler 440-2LC	-	0,60	B9ES	2611	02	BR9EIX	3981
-----	------------------------	---	------	------	------	----	--------	------

SOS EXPRESS

-	Tide Rider Cuyuna 45HP	-	0,60	BR8ES	5422	05	BR8EIX	5044
---	------------------------	---	------	-------	------	----	--------	------

SURF JET - Motomarine

260	moteur Fuji LC 26	80-97	0,60	B7HS	5110	03	BR7HIX	7067
-----	-------------------	-------	------	------	------	----	--------	------

SUZUKI - Motomarine

292	Nomad 292	-	0,70	B7HS	5110	03	BR7HIX	7067
340	C340 / F340	-	0,80	BR9EYA	7548	-	BR9EIX	3981
340	Nomad 336	-	0,70	B7HS	5110	03	BR7HIX	7067
360	SM10 / SM10D	-	0,70	B7HS	5110	03	BR7HIX	7067
370	C370 / F370	-	0,80	BR9EYA	7548	-	BR9EIX	3981
395	SM20, Wide Track 400, XR400	-	0,70	B7HS	5110	03	BR7HIX	7067
395	SM20 Hop Up Kit	-	0,70	B8ES	2411	05	BR8EIX	5044
400	C-ZRV 440	00-	0,80	BR9EYA	7548	-	BR9EIX	3981
400	L / C-ZRV 440	98-	0,70	BR10ES	4832	-	BR10EIX	6801
400	L / C-ZRV 440	99-	0,80	BR10EYA	7613	-	BR10EIX	6801
400	L440	00-	0,80	BR9EYA	7548	-	BR9EIX	3981
432	XR440	-	0,70	B7HS	5110	03	BR7HIX	7067
433	C440, C-LWS 440	-	0,80	BR9EYA	7548	-	BR9EIX	3981
433	F / C-C 440	-	0,80	BR9ES	5722	02	BR9EIX	3981
433	F440 / L440	-	0,80	BR9EYA	7548	-	BR9EIX	3981
433	SM 440M	-	0,80	-	-	-	BR9EIX	3981
500	F / C 500	-	0,80	BR9ES	5722	02	BR9EIX	3981
500	L / C / C-EID	-	0,80	BR9EYA	7548	-	BR9EIX	3981
500	L / C 500	00-	0,80	BR10EYA	7613	-	BR10EIX	6801
530	L / C 530	-	0,70	BR10ES	4832	-	BR10EIX	6801
530	L / C 550	-	0,80	BR9EYA	7548	-	BR9EIX	3981
580	L / C-EID 580	-	0,80	BR9EYA	7548	-	BR9EIX	3981
600	L / C / C-EID	-	0,80	BR9EYA	7548	-	BR9EIX	3981
650	L / C 650, L / C 700	-	0,70	BR10ES	4832	-	BR10EIX	6801
700	F / C 700	-95	0,80	BR9ES	5722	02	BR9EIX	3981
785	L / C 785	-	0,80	BR9EYA	7548	-	BR9EIX	3981
800	L / C 800	-	0,80	BR9EYA	7548	-	BR9EIX	3981
900	L / C 900	-	0,80	BR9EYA	7548	-	BR9EIX	3981
1000	L / C 1000	-	0,80	BR9EYA	7548	-	BR9EIX	3981

THUNDER JET

-	F14, F15	-	0,60	BR8ES	5422	05	BR8EIX	5044
700	F-II 700	-	0,60	BR8ES	5422	05	BR8EIX	5044
800	F-II 800	-	0,60	BR8ES	5422	05	BR8EIX	5044





TIDE RIDER

-	Moteur Cuyuna 45HP	-	0,60	BR8ES	5422	05	BR8EIX	5044
---	--------------------	---	------	-------	------	----	--------	------

ULTRANAUTICS

-	Wetbike moteur Suzuki	-	1,00	B7HS	5110	03	BR7HIX	7067
789	Seafish ST/XL/XP- mot.Suzuki	-	1,00	B7HS	5110	03	BR7HIX	7067
800	Jetfisher 1660L	91	1,00	B8HS-10	5126	-	BR8HIX	7001
800	Jetstar 1250	88-90	1,00	B8HS-10	5126	-	BR8HIX	7001
800	Jetstar 1260	91	1,00	B8HS-10	5126	-	BR8HIX	7001
800	Moteur Suzuki	92	1,00	BR8HS-10	1134	-	BR8HIX	7001
800	Seafish	88-90	1,00	B8HS-10	5126	-	BR8HIX	7001
800	Seafish ST / XL / XP	91	1,00	B8HS-10	5126	-	BR8HIX	7001
800	Wetbike	86-91	1,00	B8HS-10	5126	-	BR8HIX	7001

ULTRANAUTICS

Cyl.	Nb Cyl.	Type	Modèle				N° STOCK	N° BL		N° STOCK IX
850			Jetfisher 1670B / Riverjet 1670B	90	1,00	B8HS-10	5126	-	BR8HIX	7001
1230			Moteur Mercury	92	1,30	BUHW	2622	-	-	-

WET JET (Voir MASTERCRAFT)

WETBIKE





-			Moteur Spirit	-	1,00	B7HS	5110	03	BR7HIX	7067
-			Moteur Suzuki	-	0,80	B6HS	4510	09	BR6HIX	3419

WILD CAT

-			Brute 50HP / 75HP	-	0,60	B9ES	2611	02	BR9EIX	3981
---	--	--	-------------------	---	------	------	------	----	--------	------

YAMAHA - Motomarine

500	2	WJ	Wave Jammer (WJ500H / G / F / D)	87-90	0,60	B7HS	5110	03	BR7HIX	7067
500	2	WR	Wave Runner (WR500H / G / F / D / P / Q / R)	87-93	0,60	B7HS	5110	03	BR7HIX	7067
650	2	SJ	Super Jet (SJ650D / P / Q / R)	90-93	0,60	B8HS	5510	01	BR8HIX	7001
650	2	WR	Wave Runner LX (WR650D / P / Q / R)	90-93	0,60	B8HS	5510	01	BR8HIX	7001
650	2	WRA	Wave Runner III (WRA650D / P / Q / R / RA / T / U)	90-96	0,60	BR8HS	4322	01	BR8HIX	7001
650	2	WRB	Wave Runner (WRB650P_61 / Q_61 / RA / R_61)	91-93	0,60	B8HS	5510	01	BR8HIX	7001
650	2	WRB	Wave Runner VXR (WRB650R / S / T)	93-95	0,60	B8HS	5510	01	BR8HIX	7001
700	2	FX	FX-1 (FX700S / T)	94-95	0,60	B8HS	5510	01	BR8HIX	7001
700	2	SJ	Super Jet (SJ700S / T / AU)	94-96	0,60	B8HS	5510	01	BR8HIX	7001
700	2	SJ	SuperJet (SJ700AV)	97	0,60	B7HS	5110	03	BR7HIX	7067
700	2	SJ	Super Jet (SJ700AW)	98	0,60	B8HS	5510	01	BR8HIX	7001
700	2	SJ	Super Jet (SJ700AX / AY / AZ)	99-01	0,60	B7HS	5110	03	BR7HIX	7067
700	2	SJ	Super Jet (SJ700AA / BA ~ BH / BJ ~ BN / BP / BR)	02-16	0,60	B7HS	5110	03	BR7HIX	7067
700	2	SJ	Wave Runner Super Jet (SJ700BS)	17	0,60	B7HS	5110	03	BR7HIX	7067
700	2	RA	Wave Raider (RA700S / AT / T)	94-95	0,60	BR8HS	4322	01	BR8HIX	7001
700	2	RA	Wave Raider (RA700BU)	96	0,60	B8HS	5510	01	BR8HIX	7001
700	2	RA	Wave Raider (RA700BV)	97	0,70	B7HS	5110	03	BR7HIX	7067
700	2	WB	Wave Blaster (WB700AU / R / S / T)	93-96	0,60	B8HS	5510	01	BR8HIX	7001
700	2	WRA	Wave Runner III GP (WRA700S / T)	94-95	0,60	BR8HS	4322	01	BR8HIX	7001
700	2	WRA	Wave Runner III (WRA700V)	97	0,70	BR7HS	4122	03	BR7HIX	7067
700	2	WRB	Wave Runner Pro VXR (WRB700R / S)	93-94	0,60	BR8HS	4322	01	BR8HIX	7001
700	2	WVT	Wave Venture (WVT700T / U / W)	95-98	0,60	BR8HS	4322	01	BR8HIX	7001
700	2	XL	Wave Runner XL700 (XL700X / Y / Z / A / B / C)	99-04	0,60	BR8HS	4322	01	BR8HIX	7001
760	2	GP	Wave Runner GP760 (GP760V / W / X)	97-99	0,60	BR8HS	4322	01	BR8HIX	7001
760	2	RA	Wave Raider (RA760U)	96	0,60	BR8HS	4322	01	BR8HIX	7001
760	2	WB	Wave Blaster II (WB760U / V)	96-97	0,60	BR8HS	4322	01	BR8HIX	7001
760	2	WVT	Wave Venture 760 (WVT760V)	97	0,60	BR8HS	4322	01	BR8HIX	7001
760	2	XL	Wave Runner (XL760W / X)	98-99	0,60	BR8HS	4322	01	BR8HIX	7001
800	2	GP	Wave Runner GP800 (GP800W / X / Y)	98-00	0,60	BR8ES	5422	05	BR8EIX	5044
800	2	GP	Wave Runner GP800R (GP800AZ / AA / AB / AC / AD)	01-05	0,60	BR8ES	5422	05	BR8EIX	5044
800	2	XL	Wave Runner XL800 (XA800Y / Z)	00-01	0,60	BR8ES	5422	05	BR8EIX	5044
800	2	XLT	Wave Runner XLT800 (XA800AA / AB / AC)	02-05	0,70	BR8ES	5422	05	BR8EIX	5044
1000	4	FX	FX-140 (FX1000A / CA / B / CB / C / CB / D / E / F / G)	02-07	0,70	CR9EB	6955	-	CR9EIX	3521
1000	4	FX	FX-140 Cruiser (FX1000AB / ACB / AC / ACC / AD ~ AG)	03-08	0,70	CR9EB	6955	-	CR9EIX	3521
1050	3	EX	EX (EX1050CS)	17	0,70	CR9EB	6955	-	CR9EIX	3521
1050	3	EX	EX Deluxe (EX1050AS) / EX Sport (EX1050BS)	17	0,70	CR9EB	6955	-	CR9EIX	3521
1050	3	VX	V1 (VX1050ER) / V1 Sport (VX1050DR)	16	0,70	CR9EB	6955	-	CR9EIX	3521
1050	3	VX	VX (VX1050CR / CS)	16-17	0,70	CR9EB	6955	-	CR9EIX	3521
1050	3	VX	VX Cruiser VX1050BR VX Deluxe (VX1050AR / BR)	16	0,70	CR9EB	6955	-	CR9EIX	3521
1050	3	VX	VX Cruiser VX1050BS VX Deluxe (VX1050AS / BS)	17	0,70	CR9EB	6955	-	CR9EIX	3521
1050	3	VX	VX Limited (VX1050FR / FS)	16-17	0,70	CR9EB	6955	-	CR9EIX	3521
1100	4	FX	FX High Output (FX1100G / LG)	08-	0,70	CR9EB	6955	-	CR9EIX	3521
1100	4	FX	FX Cruiser High Output (FX1100C / CC / D / E / F / G)	04-08	0,70	CR9EB	6955	-	CR9EIX	3521
1100	4	FX	FX Cruiser High Output (FX1100AC / ACC / AD ~ AG / ALG)	04-08	0,80	CR9EB	6955	-	CR9EIX	3521
1100	4	FX	FX Cruiser High Output 50TH Anniversary Edition (FX1100BE) 06		0,80	CR9EB	6955	-	CR9EIX	3521
1100	3	RA	Wave Raider 1100 (RA1100T / U)	95-96	0,60	BR8HS	4322	01	BR8HIX	7001
1100	4	VX	VX (VX1100CP)	15	0,80	CR9EB	6955	-	CR9EIX	3521
1100	4	VX	VX Cruiser VX1100BN VX Deluxe (VX1100AN)	15	0,80	CR9EB	6955	-	CR9EIX	3521
1100	4	VX	VX Cruiser VX1100BP VX Deluxe (VX1100AP / BP)	15	0,80	CR9EB	6955	-	CR9EIX	3521
1100	4	VX	Wave Runner V1 (VX1100EP) / V1 Sport (VX1100DP)	15	0,80	CR9EB	6955	-	CR9EIX	3521
1100	4	VX	Wave Runner VX (VX1100F / G / H)	07-09	0,80	CR9EB	6955	-	CR9EIX	3521
1100	4	VX	Wave Runner VX Cruiser (VX1100AF / AGB / AGW / A)	07-09	0,80	CR9EB	6955	-	CR9EIX	3521
1100	4	VX	Wave Runner VX Cruiser (VX1100AJ / AK / AL / AM)	10-13	0,80	CR9EB	6955	-	CR9EIX	3521

Cyl.	Nb Cyl.	Type	 Modèle				N° STOCK	N° BL		N° STOCK IX
1100	4	VX	Wave Runner VX110 Deluxe (VX1100AD / AE / BF / BGA)	05-08	0,70	CR9EB	6955	-	CR9EIX	3521
1100	4	VX	Wave Runner VX110 Deluxe (VX1100BH / BJ / BK / BL / BM)	09-13	0,70	CR9EB	6955	-	CR9EIX	3521
1100	4	VX	Wave Runner VX110 Sport (VX1100D / E / CF / CG / CH)	05-09	0,70	CR9EB	6955	-	CR9EIX	3521
1100	4	VX	Wave Runner VX110 Sport (VX1100J / CK / CL / CM)	10-13	0,70	CR9EB	6955	-	CR9EIX	3521
1100	4	VX	Wave Runner VX1100 Sport (VX100CN)	14	0,70	CR9EB	6955	-	CR9EIX	3521
1100	3	WVT	Wave Venture (WVT1100U / V)	96-97	0,60	BR8HS	4322	01	BR8HIX	7001
1200	3	GP	Wave Runner GP1200 (GP1200V / W / X)	97-99	0,60	BR8HS	4322	01	BR8HIX	7001
1200	3	GP	Wave Runner GP1200 (GP1200AY / AA)	00-02	1,10	BR8ES-11	7986	-	BR8EIX	5044
1200	3	GP	Wave Runner GP1200R (GP1200AZ / ACA)	01-02	1,10	BR8ES-11	7986	-	BR8EIX	5044
1200	3	SUV	Wave Runner SUV1200 (SV1200X / Y / Z / A / B / C)	99-04	0,60	BR8HS	4322	01	BR8HIX	7001
1200	3	XL	Wave Runner XL1200 (XL1200W)	98	0,60	BR8HS	4322	01	BR8HIX	7001
1200	3	XL	Wave Runner XL1200 LTD (XA1200X / Y)	99-00	0,70	BR8ES	5422	05	BR8EIX	5044
1200	3	XLT	Wave Runner XLT 1200 (XA1200AZ / AA / AB / AC / AD)	01-05	1,10	BR8ES-11	7986	-	BR8EIX	5044
1300	3	GP	Wave Runner GP1300R (GP1300B / CB / C / CC / D ~ G)	03-08	1,10	BR8ES-11	7986	-	BR8EIX	5044
1800	4	FX	FX Cruiser Super High Output (FX1800AGR / AGS)	08	0,90	LFR6A	6668	-	-	-
1800	4	FX	FX Cruiser Super High Output (FX1800 AHR / AHZ / AJ / AK)	09-11	0,90	LFR6A	6668	-	-	-
1800	4	FX	FX Super High Output (FX1500GB / GK / HB / HK / J / K)	08-11	0,90	LFR6A	6668	-	-	-
1800	4	FY	FX High Output (FY1800H / J / K)	09-11	0,90	LFR6A	6668	-	-	-
1800	4	FY	FX Cruiser High Output (FY1800AH / AJ / AK)	09-11	0,90	LFR6A	6668	-	-	-
1800	4	FA	FX Cruiser Super High Output (FA1800AL / AM / AN)	12-13	0,90	LFR6A	6668	-	-	-
1800	4	FA	FX High Output (FA1800L / M)	12-13	0,90	LFR6A	6668	-	-	-
1800	4	FB	FX Cruiser High Output (FB1800AL / AM / AN)	12-13	0,90	LFR6A	6668	-	-	-
1800	4	FB	FX High Output (FB1800L / M)	12-13	0,90	LFR6A	6668	-	-	-
1800	4	FC	FC Cruiser SVHO (FB1800 AN)	14	0,90	LFR7A	92038	-	LFR7AIX	2309
1800	4	FX	FX Cruiser HO (FB1800A-P / AP / AR / AS)	15-17	0,90	LFR6A	6668	-	-	-
1800	4	FX	FX Cruiser SHO (FA1800AP / AR)	15-16	0,90	LFR6A	6668	-	-	-
1800	4	FX	FX Cruiser SVHO (FA1800AP / AR / AS)	15-16	0,90	LFR7A	92038	-	LFR7AIX	2309
1800	4	FX	FX Cruiser SVHO (FC1800AS / BS)	17	0,90	LFR7A	92038	-	LFR7AIX	2309
1800	4	FX	FX SVHO (FC1800P / R / S)	15-17	0,90	LFR7A	92038	-	LFR7AIX	2309
1800	4	FX	Wave Runner FX HO (FB1800N / P)	14-15	0,90	LFR6A	6668	-	-	-
1800	4	FX	Wave Runner FX HO (FB1800S)	17	0,90	LFR6A	6668	-	-	-
1800	4	FX	Wave Runner FX SHO (FA1800N / P / R)	14-16	0,90	LFR6A	6668	-	-	-
1800	4	FZ	FZR SVHO, FZS SVHO	14	0,90	LFR7A	92038	-	LFR7AIX	2309
1800	4	GP	GP1800 (GP1800S)	17	0,90	LFR6A	6668	-	-	-
1800	4	GX	Wave Runner FZR (GX1800HB / J / K / L / M)	09-13	0,90	LFR6A	6668	-	-	-
1800	4	GX	Wave Runner FZR (GX1800N / P / R)	14-16	0,90	LFR7A	92038	-	LFR7AIX	2309
1800	4	GX	Wave Runner FZS (GX1800AHK / AHR / AJ ~ AM)	09-13	0,90	LFR6A	6668	-	-	-
1800	4	GX	Wave Runner FZS (GX1800AN / AP / AR)	14-16	0,90	LFR7A	92038	-	LFR7AIX	2309
1800	4	VC	VX Cruiser HO (VC1800R / S)	16-17	0,90	LFR6A	6668	-	-	-
1800	4	VX	VXR (VX1800AK / AL / AM / AN / AP / AR / AS)	11-17	0,90	LFR6A	6668	-	-	-
1800	4	VX	VXS (VX1800K / L / AM / N / P / R)	11-16	0,90	LFR6A	6668	-	-	-



STOCK-TYPE BOUGIES D'ALLUMAGE

INBOARD & HORS-BORD

Top Vente	NGK	N° Stock	APPLICATIONS INBOARD (IN) & HORS-BORD (OUT)		CHAMPION
1	BKR6E	6962	OUT:	EVINRUDE	RC8YC-OE127 RC9YC-OE005
2	LFR5A-11	6376	OUT:	MARINEPOWER, MARINER, MERCURY, YAMAHA	REC10YC4-OE148
3	BR8HS-10	1134	OUT:	NISSAN, SUZUKI, TOHATSU, YAMAHA	/
4	BR7HS-10	1098	OUT:	NISSAN, SUZUKI, TOHATSU, YAMAHA	/
5	LFR6A-11	3672	OUT:	MARINEPOWER, MERCURY, YAMAHA	/
6	DCPR6E	3481	OUT:	JOHNSON, MARINEPOWER, MARINER, MERCURY, NISSAN, SUZUKI, TOHATSU	RA8GHC
7	DPR6EA-9	5531	OUT:	MARINEPOWER, MARINER, MERCURY, YAMAHA	/
8	BR6FS	4323	IN:	CRUSADER, INDMAR, KODIAK, MARINEPOWER, MERCURUISER, OMC, VOLVO-PENTA, YAMAHA	RV8C, RV91MC
9	BPR6EFS	3623	IN:	INDMAR, MARINEPOWER, MERCURUISER, OMC, REDLINE, VOLVO-PENTA	RS9YC-OE011 RS9YCC-OE020
10	DR7EA	7839	OUT:	HONDA	PRA7HC, RAX96C
11	DPR6EB-9	3108	OUT:	YAMAHA	/
12	BR7HS	4122	IN: OUT:	CHRYSLER-VOLVO EVINRUDE, JOHNSON, SPIRIT, YAMAHA	RL77J, L77J4
13	BP8H-N-10	4838	OUT:	MARINEPOWER, MARINER, MERCURY	/
14	BPZ8H-N-10	4495	OUT:	MARINEPOWER, MERCURY	/
15	BR6HS-10	1090	OUT:	SUZUKI, YAMAHA	/
16	BPR6ES	7822	IN: OUT:	AERO MARINE, CHRYSLER, MERCURUISER, VOLVO-PENTA EVINRUDE, JOHNSON, SUZUKI	RN9YC-OE006 RN9YCC-OE004 RN10YC-OE111
17	LFR4A-E	6499	OUT:	MERCURY	/
18	ILFR6G-E	4212	OUT:	MARINER, MERCURY	/
19	ITR4A15	5599	IN:	MERCURUISER	/
20	IZFR6K-11E	6748	OUT:	HONDA	/
21	DCPR7E	3932	OUT:	EVINRUDE, JOHNSON, MARINEPOWER, MERCURY	RA8HC
22	IZFR6F11	4095	OUT:	EVINRUDE, HONDA	/
23	CR5EH-9	6689	OUT:	HONDA	/
24	BR8HS	4322	IN: OUT:	YAMAHA MARINEPOWER, MARINER, MERCURY, SPIRIT, SUZUKI	/
25	B7HS	5110	IN: OUT:	CHRYSLER, HARDIN EVINRUDE, JOHNSON, MARINER, SUZUKI, TOHATSU	L77J L78C
26	BR6HS	3922	IN: OUT:	MERCURUISER CHRYSLER, CLINTON, EVINRUDE, FIAT NAUTICA, JOHNSON, SPIRIT, YAMAHA	RL82C-OE086 RL86C
27	B7HS-10	2129	OUT:*	EVINRUDE, MARINER, NISSAN, SELVA, SUZUKI, TOHATSU, YAMAHA	L77J4, L77JC4
28	BUHW-2	5626	OUT:	EVINRUDE, JOHNSON, MARINER, MERCURY	L78V
29	IZFR6K11	6994	OUT:	HONDA	/
30	BPR6FS	2623	OUT:	CRUSADER, MERCURUISER, REDLINE, VOLVO-PENTA	RV9YC-OE171

MOTONAUTISME (PRINCIPALES RÉFÉRENCES UTILISÉES EN MOTONAUTISME)

NGK	N° Stock	APPLICATIONS	CHAMPION
BR8ES	5422	KAWASAKI, SEE-DOO (Bombardier), YAMAHA	RN3C-OE108
DCPR8E	4339	SEE-DOO (Bombardier)	RA4HC-OE073, RA6HC-OE083, RA7YC-OE199
BR9ES	5722	ARCTO / TIGERSHARK, KAWASAKI, POLARIS, SUZUKI	RN2C-OE091
CR9EB	6955	YAMAHA	/
B7HS	5110	SUZUKI, YAMAHA	L77J, L78C
BR7ES	5122	KAWASAKI, SEE-DOO (Bombardier)	RN4C-OE098
BR9EYA	7548	ARCTO / TIGERSHARK, SUZUKI	/
LFR6A	6668	YAMAHA	/
BR8HS	4322	YAMAHA	/
BPR8ES	3923	POLARIS	RN4YC-OE170, RN6YC-OE116
B8HS	5510	YAMAHA	/
PMR9B	4717	KAWASAKI	/
BPR7ES	2023	POLARIS	RN7YC-OE018, RN7YCC-OE008
CR9EK	4548	KAWASAKI	RG92DC

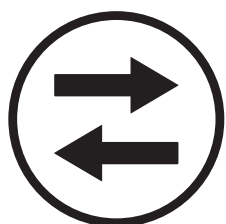

ÉQUIVALENCES

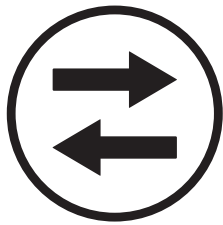

ÉQUIVALENCES

BOUGIES D'ALLUMAGE ET DE PRÉCHAUFFAGE

Attention,

Cette liste est donnée à titre indicatif. De par leurs différences de conception, matériaux, etc, les bougies produites par les différents fabricants n'ont pas exactement les mêmes caractéristiques. Se reporter au tableau d'affectation NGK pour déterminer la référence de la bougie en fonction de l'application.

ACDELCO	NGK	N° STOCK											
40TS	BP7FS	3612	44NS	BP5ES	6511	C41	B7S	3710	CS41T	BM7F	6421		
41-108	ILTR5D	5476	44S	BP5S	3011	C42CFS	BP6HS	4511	CS42	BM7A	6521		
41-602	FR5	7373	44TS	BP5FS	3412	C42CLTS	BP6EFS	3812	CS42S	BM7A	6521		
41-627	BKR4E-11	5424	44XL	B6ES	7310	C42CXLS	BP6ES	7811	CS42T	BM6F	6221		
41-803	UR6IX	7348	44XLO	BP5ES	6511	C42LTS	BP6EFS	3812	CS45	BM6A	5921		
41-812	TR6IX	3689	44XLS	BP5ES	6511	C42N	B7ES	1111	CS45T	BM6F	6221		
41-900	TR5	2238	45	B-4	3210	C42XLS	BP5ES	6511	CS49	BM4A	5628		
41-902	TR55	3951	45F	B5HS	4210	C43	B6S	3510	CSR45	BMR6A	7421		
41-904	TR5	2238	45FF	B5HS	4210	C43CXLS	BP6ES	7811	FR2LS	BKR6ES	3783		
41-907	TR5	2238	45FFS	BP5HS	4111	C43L	B-6L	3212	FR2LSK	BKR6E	6962		
41-908	BPR5EFIX-13P	3258	45L	B-4L	3112	C43N	B6ES	7310	FR3CLS	BKR5E	7938		
41-910	TR5	2238	45NS	BP5ES	6511	C44	B6S	3510	FR3CLS6	BKR5E-11	6953		
41-913	TR55	3951	45S	BP5S	3011	C44N	B6ES	7310	FR3LM	ZFR5A-11	5084		
41-919	TR55	3951	45TS	BP4FS	2230	C44NS	BP5ES	6511	FR3LS	BKR5E	7938		
41-921	TR55	3951	45XL	B6ES	7310	C44S	BP5S	3011	FR3LS6	BKR5E-11	6953		
41-928	TR55-1	2683	45XLS	BP5ES	6511	C44XL	B6ES	7310	FR3LSJ	BKR4E-11	5424		
41-929	TR55	3951	46	B-4	3210	C45	B-4	3210	FR3LSK	BKR5E	7938		
41-931	TR55IX	7164	46F	B5HS	4210	C45L	B-4L	3112	FR4LE	ZFR4F-11	4043		
41-933	PTR4B-15	5146	46FF	B5HS	4210	C46	B-4	3210	FR4LSJ	BKR4E-11	5424		
41-947	TR55	3951	46FFS	BP5HS	4111	C47	B-4	3210	FR5LS	BKR5E	7938		
41-948	TR4IX	7300	46N	B5ES	6410	C47W	B-4	3210	LM46	B4-LM	3410		
41-987	PTR5C-13	7740	46S	BP5S	3011	C49	B-2	3110	LM49	B4-LM	3410		
41F	B6HS-10	1052	46TS	BP4FS	2230	C81	AB-8	7909	M40FF	B9HS	5810		
41TS	BP6FS	3512	46XL	B5ES	6410	C82	AB-7	3010	M40FFX	B9HS-10	3626		
41XL	B9ES	2611	46XLS	BP4ES	6928	C83	AB-7	3010	M41FF	B8HS	5510		
41XLS	BP7ES	2412	47FF	B-4H	4110	C85	AB-6	2910	M41K	B8S	3810		
42F	B6HS	4510	47S	BP-4	2911	C86	AB-6	2910	M42FF	B7HS	5110		
42FF	B6HS	4510	47XL	B4ES	4129	C87	AB-6	2910	M42K	B7S	3710		
42FS	BP6HS	4511	48	B-4	3210	C88	AB-2	3020	M43FF	B6HS	4510		
42S	BP6S	3111	412XLS	BP7ES	2412	C88L	AB-2	3020	M43S	BP6S	3111		
42TS	BP6FS	3512	414XLS	BP6ES	7811	C421	B6S	3510	M44B	B6S	3510		
42XL	B8ES	2411	420Z	B-4H	4110	CFR1CLS	BKR7E	6097	M44C	B6S	3510		
42XLS	BP6ES	7811	422Z	B5HS	4210	CFR2CLS	BKR6E	6962	M44L	B-6L	3212		
43F	B6HS	4510	425F	B6HS	4510	CR42CFS	BPR6FS	2623	M45	B-4	3210		
43FFS	BP6HS	4511	425Z	B6HS	4510	CR42CXLS	BPR6ES	7822	M45FF	B5HS	4210		
43FS	BP6HS	4511	426FS	BP6HS	4511	CR42N	BR7ES	5122	M47	B-4	3210		
43N	B7ES	1111	430Z	B7HS	5110	CR43	BR6S	3522	M86	AB-6	2910		
43S	BP6S	3111	436XLS	BP9ES	7526	CR43CXLS	BPR6ES	7822	MB42K	B6S	3510		
43TS	BP6FS	3512	438XLS	BP8ES	2912	CR43K	BR6S	3522	MC41	B8S	3810		
43XL	B7ES	1111	440T	B7FS	3027	CR43N	BR6ES	4922	MC41F	B8HS	5510		
43XLS	BP6ES	7811	440XLS	BP8ES	2912	CR43S	BP6S	3111	MC42	B8S	3810		
44	B6S	3510	445Z	B8HS	5510	CR43TS	BPR5FS-11	2924	MC42F	B7HS	5110		
44F	B5HS	4210	12620540	ILTR5D	5476	CR43TSM	BPR5FS-11	2924	MC44	B7S	3710		
44FF	B5HS	4210	B43	BP6S	3510	CR44N	BR6ES	4922	MC104F	C6HSA	3228		
44FFS	BP5HS	4111	B44FS	BP5HS	4111	CR44NS	BPR5ES	7422	MC122F	D8HA	7112		
44L	B-6L	3212	B44S	BP5S	3011	CR44TS	BPR5FS-11	2924	MC124FS	D6HA	6512		
44N	B6ES	7310	B45	B-4	3210	CR45TS	UR4	6630	MR42K	BR6S	3522		
			B4021	B6S	3510	CS40	BM7A	6521	MR42LTS	BPR6EFS	3623		
			B4031	B-4	3210	CS41	BM7A	6521	MR43LTS	BPR6EFS	3623		

À TITRE INDICATIF

MR43T	BR6FS	4323
MR44C	BR6S	3522
MR44T	BR5FS	4123
MR45	B-4	3210
R41CF	BR7HS	4122
R41CXL	BR9ES	5722
R41CXLS	BPR7ES	2023
R41TS	BPR6FS	2623
R42CF	BR6HS	3922
R42CFS	BPR6HS	7022
R42CLTS	BPR6EFS	3623
R42CT	BR6FS	4323
R42CTS	BPR6FS	2623
R42CXL	BR8ES	5422
R42CXLS	BPR6ES	7822
R42FS	BPR6HS	7022
R42LTS	BPR6EFS	3623
R42LTSM	BPR5EFS-13	2359
R42S	BP6S	3111
R42T	BR6FS	4323
R42TS	BPR6FS	2623
R42TSM	BPR6FS	2623
R42TX	BR6FS	4323
R42XL	BR8ES	5422
R42XLS	BPR6ES	7822
R42XLSM	ZGR5C	6334
R43	BR6S	3522
R43C	BR6S	3522
R43CFS	BPR6HS	7022
R43CNTSE	TR5-1	7060
R43CS	BP6S	3111
R43CT	BR6FS	4323
R43CTS	BPR6FS	2623
R43CTS6	BPR6FS	2623
R43CXL	BR7ES	5122
R43CXLS	BPR6ES	7822
R43FS	BPR6HS	7022
R43LTS	BPR6EFS	3623
R43LTSE	TR4	3754
R43LTSX	BPR6EFS-13	2327
R43N	BR7ES	5122
R43NTSE	TR5-1	7060
R43S	BP6S	3111
R43T	BR6FS	4323
R43TS	BPR6FS	2623
R43TSK	BPR6FS	2623
R43TSX	BPR6FS	2623
R43TX	BR6FS	4323
R43XL	BR7ES	5122
R43XLS	BPR6ES	7822
R44	BR6S	3522
R44CF	BR5HS	3722
R44CNTSE	TR5-1	7060
R44CXL	BR6ES	4922
R44CXLS	BPR5ES	7422
R44F	BR5HS	3722
R44LTS	BPR5EFS	2223
R44LTS6	BPR5EFS-13	2359
R44LTS6K	BPR5EFS-13	2359
R44LTSM	TR4	3754
R44LTSM6	TR4	3754
R44N	BR6ES	4922
R44NS	BPR5ES	7422
R44NTSE	TR5-1	7060
R44S	BP5S	3011
R44T	BR5FS	4123
R44TS	BPR5FS	2423
R44TSX	BPR5FS-15	3124
R44TX	BR5FS	4123
R44XL	BR6ES	4922
R44XLS	BPR5ES	7422
R44XLS6	BPR4ES-13	2642
R44XLSE	ZGR5C	6334
R44XLSM	ZGR5C	6334

R45	BR6S	3522
R45LTS6	BPR5EFS-13	2359
R45LTS6K	BPR5EFS-13	2359
R45NS	BPR5ES	7422
R45NSX	BPR5ES-13	3154
R45NTSE	TR5-1	7060
R45S	BP5S	3011
R45T	BR5FS	4123
R45TSX	BPR4FS-15	2727
R45XL	BR6ES	4922
R45XLS	BPR5ES	7422
R46	BR6S	3522
R46LTS	BPR5EFS	2223
R46N	BR5ES	4722
R46S	BP-4	2911
R46SZ	XR45IX	7293
R46T	BR5FS	4123
R46TS	BPR4FS	1127
R46TSX	BPR4FS-15	2727
R46TX	BR5FS	4123
R46XL	BR5ES	4722
R46XLS	BPR4ES	7222
R47S	BP-4	2911
R415TS	BPR6FS	2623
R425LTS	BPR6EFS	3623
R425TS	BPR6FS	2623
R426FS	BPR6HS	7022
S40F	B9HS	5810
S40FR	BR9HS	4522
S40XL	B10ES	7928
S40XLG	B9ECS	7058
S40XLR	BR8ES	5422
S41F	B8HS	5510
S41FG	B7HCS	2421
S41FR	BR8HS	4322
S41XL	B9ES	2611
S41XLG	B8ECS	2821
S41XLR	BR9ES	5722
S42	B7S	3710
S42F	B7HS	5110
S42FR	BR7HS	4122
S42XL	B8ES	2411
S42XLR	BR8ES	5422
S43XL	B7ES	1111
S43XLR	BR7ES	5122
S44	B6S	3510
S44F	B5HS	4210
S44XL	B6ES	7310
S45F	B5HS	4210
S46	B-4	3210
S81F	AB-8	7909
S82F	AB-8	7909
S83F	AB-7	3010
S85F	AB-6	2910
S102F	C7HSA	4629
S104F	C6HSA	3228
S121F	D8HA	7112
S121XL	D8EA	2120
S122F	D8HA	7112
S123XL	D7EA	7912
S124FS	D6HA	6512
S404XLG	B10EG	3630
S408XLG	B9EG	3530
SB41	B7S	3710
SN46	B-4	3210
SV4XL	BUE	2322
SV41XL	BUE	2322
TC42	B8S	3810
TC45	B6S	3510
TC49	B-2	3110
TC81	AB-8	7909
TC82	AB-8	7909
TC83	AB-7	3010
TC85	AB-6	2910

TC86	AB-6	2910
V40FFK	BUHW-2	5626
V40FFM	BUHW	2622
V40FFS	BUH	2422
VB40FFM	BUHXW-1	5526
VR40FFK	BUZHW-2	2173
VR40FFM	BUZHW	2147

AET		NGK N° STOCK	
11 721 655	Y-924J	7906	
11 721 866	Y-924J	7906	

APRILIA		NGK N° STOCK	
297542	DR8EA	7162	
297547	DR8EB	4855	
297830	BR10EG	3830	
297920	CR8E	1275	
297921	CR8EIX	4218	
297942	DCPR9E	2641	
297945	R0045J-10	7400	
897055	BR8ES	5422	
8122586	DR7EA	7839	
8176075	BPR4HS	7823	
8206870	BR7HS	4122	
8206871	BR8HS	4322	
8206873	BR8ES	5422	
8206915	BR9ES	5722	
8224684	CR7EB	4663	
8224685	CR9EB	6955	
8520007	CR7E	4578	
8550352	CR7E	4578	
8560146	CR7EKB	4455	
8570084	CR8EB	7784	
8600008	BR9ECM	3252	
2BEN000181	CPR8E	7411	
2BEN000276	CPR8E	7411	
2BEN000319	ZMR7AP	6914	

BERU		NGK N° STOCK	
0100 220 103	Y-207T	1239	
0100 220 115	Y-112R1	1032	
0100 220 118	Y-705RS	1249	
0100 220 119	Y-705RS	1249	
0100 221 107	Y-924J	7906	
0100 221 125	Y-924J	7906	
0100 221 133	Y-924J	7906	
0100 221 135	Y-924J	7906	
0100 221 145	Y-924J	7906	
0100 221 148	Y-128T	7227	
0100 221 152	Y-204TS1	3829	
0100 221 155	Y-924J	7906	
0100 221 163	Y-924J	7906	
0100 222 301	Y-810	6929	
0100 222 302	Y-810	6929	
0100 226 107	Y-755RS	7771	
0100 226 120	Y-112R1	1032	
0100 226 185	Y-924J	7906	
0100 226 186	Y-924J	7906	
0100 226 189	Y-924J	7906	
0100 226 194	Y-707RS	4937	
0100 226 229	Y-924J	7906	
0100 226 366	Y-924J	7906	
0100 226 381	Y-937J	7503	
0100 230 102	Y-162R1	2431	
0100 231 109	Y-757RS	4018	
0 100 226 254	Y-924J	7906	
0 100 226 307	Y-707RS	4937	
0 100 226 438	Y-924J	7906	
0 100 226 441	Y-924J	7906	
0 100 226 442	Y-924J	7906	
0 100 226 444	Y-924J	7906	
0 100 226 447	Y-924J	7906	
0 100 226 448	Y-924J	7906	

0 100 226 451	Y-924J	7906
0 100 226 453	Y-924J	7906
0 100 230 103	Y-162R1	2431
0 100 230 106	Y-755RS	7771
0 100 230 107	Y-755RS	7771
0 100 800 037	Y-271-2	7467
0 100 800 041	Y-175-2	6230
0 100 800 043	Y-106-1	6525
0 100 800 044	Y-709R	3238
0 100 800 045	YE01	2649

BMW		NGK N° STOCK	
1 342 836	BKR7EKC	7354	
2 343 144	D8EA	2120	
7 650 676.3	BKR7EKC	7354	
7 653 439	CR8EB	7784	
7 664 404	DR8EB	4855	
7 671 301	DCPR8EKC	7168	
7 671 302	BKR7EKC	7354	
7 677 560	DCPR8EKC	7168	
7 681 415	BKR7EKC	7354	
7 710 636	CR9EKB	2305	
7 710 681	MAR9B-JDS	1316	
7 719 772	LMAR9D-J	1633	
7 722 278	MAR9B-JDS	1316	
7 726 112	MAR8B-JDS	8765	
7 728 634	DCPR8EKC	7168	
7 728 657	LMAR8A1-8	92288	
8 532 942	LMAR8D-J	93444	
12 12 1 342 125	BKR7EKC-N	2095	
12 12 1 342 836	BKR7EKC	7354	
12 12 2 343 144	D8EA	2120	
12 12 7 650 676	BKR7EKC	7354	
12 12 7 650 676.3	BKR7EKC	7354	
12 12 7 653 439	CR8EB	7784	
12 12 7 653 771	BKR7EKC	7354	
12 12 7 664 404	DR8EB	4855	
12 12 7 671 301	DCPR8EKC	7168	
12 12 7 671 302	BKR7EKC	7354	
12 12 7 677 560	DCPR8EKC	7168	
12 12 7 690 603	DCPR8E	4339	
12 12 7 699 116	KR9CI	7795	
12 12 7 710 636	CR9EKB	2305	
12 12 7 710 681	MAR9B-JDS	1316	
12 12 7 719 772	LMAR9D-J	1633	
12 12 7 722 278	MAR9B-JDS	1316	
12 12 7 726 112	MAR8B-JDS	8765	
12 12 7 728 634	DCPR8EKC	7168	
12 12 7 728 657	LMAR8A1-8	92288	
12 12 8 532 942	LMAR8D-J	93444	

BOMBARDIER		NGK N° STOCK	
415 129 484	PFR7AB	93322	
512 059 533	BR9ECS-5	6669	
512 060 294	PZFR6F	7550	

BOSCH		NGK N° STOCK	
F000KE0P34	BPR6ES	7822	
F000KE0P40	BKR6ES-11	5553	
F000KE0P41	BKR5ES-11	2382	
F5DC	BCP7ES	5030	
F5DP	BCP7ES	5030	
F5DTC	BCP7ET	2078	
F6DC	BCP6ES	4930	
F6DCOR	BKR6E	6962	
F6DSR	BKR6EIX	6418	
F6DTC	BCP6ET	4563	
F6MPP332	ILFR6A	3588	
F6NPP332	ILFR6A	3588	
F7DCO	BCP6ES	4930	
F7DCOR	BKR6E	6962	
F7DCR4	BKR6ES	3783	
F7DP	BCP6ES	4930	

À TITRE INDICATIF

BOSCH	NGK	N° STOCK
F7DTC	BCP6ET	4563
F7HPP222U	PZFR6J-11	3586
F8DC0	BCP5ES	7496
F8DCOR	BKR5E	7938
F8DER	BKR6EZB	4293
F8LGR	ZFR5F	5165
F8LGR2	ZFR5F	5165
F9DCO	BCPR4ES-11	2378
F9LGR	ZFR4F-11	4043
FGR6KDEO	LKR8A	5214
FGR7DPP10	BKR6EIX-11P	2574
FGR7DQC	BKR6EKUB	3584
FGR7DQE	BKR6EKUB	3584
FGR7DQE+	BKR6EKUB	3584
FGR7DQEO	BKR6EKUB	3584
FGR7DQEO	BKR6EKUB	3584
FGR8KQC	BKR5EKUP	2890
FGR8KQE	BKR5EKUP	2890
FQR8DE	BKR6EZB	4293
FQR8LE2	ZFR5F	5165
FQR8LEU2	ZFR5F-11	2262
FR5DCX	BCPR7E-11	1267
FR5DTC	BCPR7ET	2164
FR5LDC	BKR7EKC	7354
FR6D+	BKR6E	6962
FR6DC	BKR6E	6962
FR6DC+	BKR6E	6962
FR6DC2	BKR6E	6962
FR6DCX	BKR6E-11	2756
FR6DE	BKR6E	6962
FR6DP	BKR6E	6962
FR6DPP21	BCPR6EP-N-8	5275
FR6DPP22	BKR6EP-8	2215
FR6DPP33X	BCPR6EIX-11	4919
FR6DPX	BKR6E-11	2756
FR6DTC	BCPR6ET	2197
FR6DTCW	BKR5EKC	5216
FR6KDE0	BKR6EKE	5649
FR6KDE1	BKR6EKE	5649
FR6KPP33+	BKR6EIX	6418
FR6KPP33X+	BCPR6EIX-11	4919
FR6MPP332	ILFR6A	3588
FR7D+	BKR6E	6962
FR7D+X	BKR6E-11	2756
FR7DC	BKR6E	6962
FR7DC+	BKR6E	6962
FR7DC0	BKR6ES	3783
FR7DC2	BKR6E	6962
FR7DC4	BKR6ES	3783
FR7DCO	BKR6E	6962
FR7DCX	BKR6E-11	2756
FR7DCX+	BKR6E-11	2756
FR7DE	BKR6EZ	4619
FR7DP	BKR6E	6962
FR7DPP10	BKR6EIX	6418
FR7DPX	BKR6E-11	2756
FR7DTC	BCPR6ET	2197
FR7HC0X	ZFR5E-11	4435
FR7HPP332	PZFR5N-11T	7742
FR7KC	BKR6EY	3696
FR7KC+	BKR6EY	3696
FR7KI30	FR6EI	2687
FR7KPP332	IZFR6H11	4294
FR7NI33	ILFR6B	6481
FR7NI33	ILFR6B	6481
FR7NI332S	ILFR6K8	94040
FR7SE	ILFR6C-11	5788
FR8D+	BKR5E-11	6953
FR8D+X	BKR5E-11	6953
FR8DC	BKR5E	7938
FR8DC+	BKR5EZ	7642
FR8DCX	BKR5E-11	6953

FR8DCX+	BKR5E-11	6953
FR8DE	BKR5EZ	7642
FR8DPX	BKR5E-11	6953
FR8DS	BKR5EIX	6341
FR8DX	BKR5E-11	6953
FR8HDC	BKR5EKB-11	3967
FR8HDC+	BKR5EKB-11	3967
FR8HP	ZFR5F-11	2262
FR8KC+	BKR5EYA	2087
FR8KCU	BKR5EYA-11	2526
FR8LC	ZFR5F	5165
FR8SE0	LFR6C-11	5788
FR9DC	BKR5E	7938
H10B	BP4FS	2230
H10BC	BP4FS	2230
H10C	BP4FS	2230
H2CS	B9EFS	1085
H3CS	B8EFS	1049
H5D	BP7EFS	3526
H5DC	BP7EFS	3526
H5DCO	BP7EFS	3526
H5DP	BP7EFS	3526
H6B	BP6FS	3512
H6BC	BP6FS	3512
H6D	BP6EFS	3812
H6DC	BP6EFS	3812
H6DCO	BP6EFS	3812
H6DP	BP6EFS	3812
H7CC	BR6EF	3177
H7CP	BR6EF	3177
H7D	BP6EFS	3812
H7DC	BP6EFS	3812
H7DCO	BP6EFS	3812
H7DCY	BP6EFS-13	2830
H7DP	BP6EFS	3812
H8B	BP5FS	3412
H8BC	BP5FS	3412
H8BP	BP5FS	3412
H8DC	BP5EFS	3712
H8DP	BP5EFS	3712
H9B	BP4FS	2230
H9BC	BP4FS	2230
H9BCY	BPR4FS-15	2727
H9D	BP5EFS	3712
H9DC	BP5EFS	3712
H9HP	BP5EFS	3712
HGR6KQC	BUR6EFSZ	6837
HGR7KQC	BUR6EFSZ	6837
HR10A	BR5FS	4123
HR10AC	BR5FS	4123
HR10ACY	BR5FS	4123
HR10AY	BR5FS	4123
HR10B	BPR4FS	1127
HR10BC	BPR4FS	1127
HR10BCX	BPR4FS-11	2527
HR10BCY	BPR4FS-15	2727
HR10BX	BPR4FS-11	2527
HR10BY	BPR4FS-15	2727
HR6B	BPR6FS	2623
HR6BC	BPR6FS	2623
HR6BP	BPR6FS	2623
HR6D	BPR6EFS	3623
HR6D+	BPR6EFS	3623
HR6DC	BPR6EFS	3623
HR6DC+	BPR6EFS	3623
HR6DP	BPR6EFS	3623
HR6DS	BPR6EFS	3623
HR7D+	BPR6EFS	3623
HR7DC	BPR6EFS	3623
HR7DC+	BPR6EFS	3623
HR7DCO	BPR6EFS	3623
HR7DCY	BPR6EFS-15	4871
HR7DCY+	BPR6EFS-15	4871
HR8A	BR5FS	4123

HR8AC	BR5FS	4123
HR8ACY	BR5FS	4123
HR8AP	BR5FS	4123
HR8APY	BR5FS	4123
HR8AY	BR5FS	4123
HR8B	BPR5FS	2423
HR8BC	BPR5FS	2423
HR8BCY	BPR5FS-15	3124
HR8BP	BPR5FS	2423
HR8BPX	BPR5FS-11	2924
HR8BPY	BPR5FS-15	3124
HR8BY	BPR5FS-15	3124
HR8D+	BPR5EFS	2223
HR8DC+	BPR5EFS	2223
HR8DCV+	BPR5EFS-13	2359
HR8LCO	TR5-1	7060
HR8LPO	TR5-1	7060
HR9A	BR5FS	4123
HR9AC	BR5FS	4123
HR9ACY	BR5FS	4123
HR9AP	BR5FS	4123
HR9APY	BR5FS	4123
HR9AY	BR5FS	4123
HR9B	BPR4FS	1127
HR9BC	BPR4FS	1127
HR9BC+	BPR4FS	1127
HR9BCY	BPR4FS-15	2727
HR9BCY+	BPR4FS-15	2727
HR9BP	BPR4FS	1127
HR9BPX	BPR4FS-11	2527
HR9BPY	BPR4FS-15	2727
HR9BY	BPR4FS-15	2727
HR9D	BPR5EFS	2223
HR9DC	BPR5EFS	2223
HR9DCX	BPR5EFS-13	2359
HR9DCY	TR55IX	7164
HR9DPX	TR5IX	7397
HR9DPY	TR55IX	7164
HR9LCX	TR5-1	7060
HS5E	BM7F	6421
HS6E	BM6F	6221
HS7E	BM6F	6221
HS7F	BM6F	6221
HS8E	BM6F	6221
M4A	AB-7	3010
M4A1	AB-8	7909
M4A2	AB-7	3010
M4AC	AB-7	3010
M5A	AB-7	3010
M5AC	AB-7	3010
M7A	AB-6	2910
M7AC	AB-7	3010
M8A	AB-6	2910
M8AC	AB-6	2910
M8AC0	AB-6	2910
M8AO	AB-6	2910
M10A	AB-6	2910
M10AC	AB-6	2910
M10ACO	AB-6	2910
M10AO	AB-6	2910
M35T1	AB-2	3020
M45T1	AB-6	2910
M95T1	AB-6	2910
M95T5	AB-6	2910
M145T1	AB-6	2910
M145T5	AB-6	2910
M175T5	AB-6	2910
M225P11S	AB-7	3010
M225T1	AB-7	3010
M240T1	AB-7	3010
M260T1	AB-8	7909
M280T1	AB-8	7909
U175T1	C6HSA	3228
U260T1	CR6HS	7023

U4AC	C6HSA	3228
U5AC	C5HSA	4429
U6AC	CR4HSA	2430
UR2CC	CR8E	1275
UR3AC	CR7HSA	4549
UR3CC	CR7E	4578
UR4AC	CR6HS	7023
UR4AS	CR6HS	7023
UR5	CR7HSA	4549
UR6AC	CR6HS	7023
UR6DC	CPR7EA-9	3901
USR4AC	CMR6H	3365
USR7AC	CMR6H	3365
VR5NC	LKAR8A-9	4786
W06AS	BR10HIX	6692
W06CS	B11EGV	5831
W07AS	BR10HIX	6692
W07CS	B10EGV	5927
W08AS	BR9HIX	5687
W08CS	B10EGV	5927
W2A	B9HS	5810
W2AC	B9HS	5810
W2AP	BR9HIX	5687
W2AS	BR9HIX	5687
W2C	B10ES	7928
W2CO	B10ES	7928
W2CS	BR10EIX	6801
W2D	BP9ES	7526
W3A	B8HS	5510
W3AC	B8HS	5510
W3AO	B8HS	5510
W3AP	B8HS	5510
W3AS	BR8HIX	7001
W3C	B9ES	2611
W3CO	B9ES	2611
W3CP	B9ES	2611
W3CS	BR9EIX	3981
W3DPO	BPR8EIX	6684
W4A	B8HS	5510
W4A1	B8HS	5510
W4A2	B8HS	5510
W4A5	B8HS	5510
W4AC	B8HS	5510
W4AP	B8HS	5510
W4AS	BR8HIX	7001
W4C	B8ES	2411
W4C1	B8ES	2411
W4C2	B7ES	1111
W4C3	B7HS	5110
W4CC	B8ES	2411
W4CP	BR8EIX	5044
W4CPX	B8ES	2411
W4CS	BR8EIX	5044
W4DPO	BPR8EIX	6684
W4E2	B7S	3710
W5A	B7HS	5110
W5AC	B7HS	5110
W5AP	B7HS	5110
W5AS	BR7HIX	7067
W5B	BP7HS	5111
W5BP	BP7HS	5111
W5C	B7ES	1111
W5CC	B7ES	1111
W5CP	B7ES	1111
W5CS	BR7EIX	6664
W5D	BP7ES	2412
W5D1	BP7ES	2412
W5DC	BP7ES	2412
W5DCO	BP7ES	2412
W5DCX	BP7ES-11	2712
W5DP	BP7ES	2412
W5DPO	BPR7EIX	4055
W5DPX	BP7ES-11	2712
W5E	B7S	3710

À TITRE INDICATIF

W5EC	B7S	3710
W5EP	B7S	3710
W6AC	B6HS	4510
W6AS	BR6HIX	3419
W6B	BP6HS	4511
W6BC	BP6HS	4511
W6BP	BP6HS	4511
W6CC	B6ES	7310
W6D	BP6ES	7811
W6D1	BP6ES	7811
W6DC	BP6ES	7811
W6DPO	BPR6EIX	6637
W7A	B6HS	4510
W7AO	B6HS	4510
W7A00	B6HS	4510
W7AP	B6HS	4510
W7B	BP6HS	4511
W7BP	BP6HS	4511
W7C	B6ES	7310
W7CC	B6ES	7310
W7CCO	B6ES	7310
W7CP	B6ES	7310
W7D0	BP6ES	7811
W7DC	BP6ES	7811
W7DCR	BPR6ES	7822
W7DCX	BP6ES-11	1212
W7DP	BP6ES	7811
W7DPX	BP6ES-11	1212
W7DX	BP6ES-11	1212
W7E	B6S	3510
W7EC	B6S	3510
W7EP	B6S	3510
W7F	BP6S	3111
W7FC	BP6S	3111
W8A	B5HS	4210
W8AC	B5HS	4210
W8AO	B5HS	4210
W8AP	B5HS	4210
W8B	BP5HS	4111
W8BC	BP5HS	4111
W8BP	BP5HS	4111
W8C	B5ES	6410
W8CC	B5ES	6410
W8CCX	B5ES	6410
W8CO	B5ES	6410
W8CP	B5ES	6410
W8D	BP5ES	6511
W8DC	BP5ES	6511
W8DCO	BP5ES	6511
W8DCX	BP5ES-11	7311
W8DP	BP5ES	6511
W8DPX	BP5ES-11	7311
W8DX	BP5ES-11	7311
W8E	B6S	3510
W8EC	B6S	3510
W8F	BP5S	3011
W8FC	BP5S	3011
W9A	B-4H	4110
W9AC	B5HS	4210
W9AC1	B-4L	3112
W9ACO	B5HS	4210
W9AO	B-4H	4110
W9C	B4ES	4129
W9CC	B4ES	4129
W9D	BP5ES	6511
W9DC	BP5ES	6511
W9DCO	BP5ES	6511
W9DCX	BP5ES-11	7311
W9DP	BP5ES	6511
W9DPX	BP5ES-11	7311
W9E	B-4	3210
W9EC	B-4	3210
W9ECO	B4-LM	3410
W9EO	B4-LM	3410

W9F	BP5S	3011
W9FC	BP5S	3011
W10A	B-4H	4110
W10AC	B-4H	4110
W10C	B4ES	4129
W10CC	B4ES	4129
W10D	BP4ES	6928
W10DC	BP4ES	6928
W10E	B-4	3210
W10F	BP-4	2911
W10FC	BP-4	2911
W11EO	B4-LM	3410
W12A	B-4H	4110
W12E	B-2	3110
W45T1	B-4H	4110
W45T3	B-4	3210
W95T1	B-4H	4110
W95T2	B4ES	4129
W95T3	B-4	3210
W95T6	BP-4	2911
W95TR6	BP-4	2911
W125T1	B-4H	4110
W125T2	B4ES	4129
W125T3	B-4	3210
W125T30	BP5ES	6511
W125T4	B-4H	4110
W125T6	BP5S	3011
W125TR2	BR5ES	4722
W125TR3	BR6S	3522
W125TR30	BPR5ES	7422
W125TR6	BP5S	3011
W145M1	B5HS	4210
W145M2	B5ES	6410
W145T1	B5HS	4210
W145T11	B5HS	4210
W145T2	B5ES	6410
W145T3	B6S	3510
W145T30	BP5ES	6511
W145T35	BP5HS	4111
W145T6	BP5S	3011
W145TR2	BR5ES	4722
W145TR3	BR6S	3522
W145TR30	BPR5ES	7422
W145TR6	BP5S	3011
W160T2	B6ES	7310
W160T30	BP5ES	6511
W175T1	B6HS	4510
W175T2	B6ES	7310
W175T3	B6S	3510
W175T30	BP6ES	7811
W175T35	BP6HS	4511
W175T7	BP6HS	4511
W175TR1	BR6HS	3922
W175TR2	BR6ES	4922
W175TR30	BPR6ES	7822
W175TR35	BPR6HS	7022
W175Z1	B6HS	4510
W200T27	BP6ES	7811
W200T30	BP6ES	7811
W200T35	BP6HS	4511
W200TR30	BPR6ES	7822
W215P21	BPR7EIX	4055
W215T30	BP6ES	7811
W220T30	BP6ES	7811
W225S1S	BR7HIX	7067
W225S2S	BR7EIX	6664
W225T1	B7HS	5110
W225T2	B7ES	1111
W225T3	B7S	3710
W225T35	BP7HS	5111
W225T7	BPR7HS	6422
W225TR1	BR7HS	4122
W225TR2	BR7ES	5122
W225TR30	BPR7ES	2023

W230T30	BP7ES	2412
W235P21	BP7ES	2412
W240M1	B8HS	5510
W240MZ1	B8HS	5510
W240T1	B8HS	5510
W240T2	B8ES	2411
W240T28	B8ES	2411
W240T3	B7S	3710
W250P21	BP7ES	2412
W250T1	B8HS	5510
W250T2	B8ES	2411
W250TR2	BR8ES	5422
W255T30	BP7ES	2412
W260M1	B8HS	5510
W260MZ1	B8HS	5510
W260MZ2	B9ES	2611
W260S1S	BR8HIX	7001
W260S2S	BR8EIX	5044
W260T1	B8HS	5510
W260T20	B8ES	2411
W265P21	BPR9EIX	6853
W275T1	B8HS	5510
W275T2	B9ES	2611
W280MZ1	B8HS	5510
W280MZ2	B9ES	2611
W280S1S	BR9HIX	5687
W280S2S	BR9EIX	3981
W300T1	B9HS	5810
W300T2	B10ES	7928
W300T30	BP9ES	7526
W310S1S	BR9HIX	5687
W310S2S	BR10EIX	6801
W330T1	B9HS	5810
W340S1S	BR9HIX	5687
W340S2S	B10EGV	5927
W370S1S	BR10HIX	6692
W400S1S	BR10HIX	6692
W400S2S	B11EGV	5831
WA95T40	BP4FS	2230
WA95TR4	BR5FS	4123
WA95TR40	BPR4FS	1127
WA125T30	BP5EFS	3712
WA125T40	BP4FS	2230
WA125TR30	BPR5EFS	2223
WA125TR4	BR5FS	4123
WA125TR40	BPR4FS	1127
WA145T40	BP5FS	3412
WA145TR4	BR5FS	4123
WA145TR40	BPR5FS	2423
WA175T30	BP6EFS	3812
WA200T30	BP6EFS	3812
WA200T40	BP6FS	3512
WA200TR30	BPR6EFS	3623
WA200TR40	BPR6FS	2623
WA225T30	BP7EFS	3526
WAK145T3	BM6F	6221
WAK225T3	BM7F	6421
WEA	BUH	2422
WEC	BUE	2322
WET1	BUH	2422
WET2	BUE	2322
WG235T28	BP7ES	2412
WG250P21	BPR9EIX	6853
WG250T28	BPR8EIX	6684
WG265T2SP	BPR9EIX	6853
WKA145T3	BM6A	5921
WKA145T6	BPM6A	7021
WKA145TR6	BPMR6A	6726
WKA175T3	BM6A	5921
WKA175T6	BPM6A	7021
WKA200TR6	BPMR6A	6726
WKA225T3	BM7A	6521
WKA225T6	BPM7A	7321
WO6CS	B11EGV	5831

WR20C	BR10ES	4832
WR30C	BR9ES	5722
WR30CS	BR9EIX	3981
WR30CTC	BR9ET	4528
WR40C	BR8ES	5422
WR40DPO	BPR8EIX	6684
WR5A	BR7HS	4122
WR5AC	BR7HS	4122
WR5BC	BPR7HS	6422
WR5C	BR7ES	5122
WR5CC	BR7ES	5122
WR5CP	BR7ES	5122
WR5D	BPR7ES	2023
WR5D+	BPR7ES	2023
WR5DC	BPR7ES	2023
WR5DC+	BPR7ES	2023
WR5DP	BPR7ES	2023
WR5DS	BPR7EIX	4055
WR6AC	BR6HS	3922
WR6BC	BPR6HS	7022
WR6CC	BR6ES	4922
WR6D	BPR6ES	7822
WR6DC	BPR6ES	7822
WR6DC+	BPR6ES	7822
WR6DP	BPR6ES	7822
WR6DPO	BPR6EIX	6637
WR6DPX	BPR6ES-11	4824
WR6DS	BPR6EIX	6637
WR7A	BR6HS	3922
WR7AC	BR6HS	3922
WR7B	BPR6HS	7022
WR7B+	BPR6HS	7022
WR7BC	BPR6HS	7022
WR7BC+	BPR6HS	7022
WR7BP	BPR6HS	7022
WR7C	BR6ES	4922
WR7CC	BR6ES	4922
WR7CCX	BR6ES-11	3824
WR7CP	BR6ES	4922
WR7CPX	BR6ES-11	3824
WR7D	BPR6ES	7822
WR7D+	BPR6ES	7822
WR7DC	BPR6ES	7822
WR7DC+	BPR6ES	7822
WR7DC2	BPR6ES	7822
WR7DCX	BPR6ES-11	4824
WR7DCX+	BPR6ES-11	4824
WR7DS	BPR6EIX	6637
WR7EC	BR6S	3522
WR7F	BP6S	3111
WR7LT+	BCPR6ET	2197
WR8AC	BR5HS	3722
WR8B+	BPR5HS	6222
WR8BC	BPR5HS	6222
WR8BC+	BPR5HS	6222
WR8C	BR5ES	4722
WR8CC	BR5ES	4722
WR8CP	BR5ES	4722
WR8D	BPR5ES	7422
WR8D+	BPR5ES	7422
WR8DC	BPR5ES	7422
WR8DC+	BPR5ES	7422
WR8DC4	BPR5ES	7422
WR8DCO	BPR5ES	7422
WR8DCO4	BPR5ES	7422
WR8DCX	BPR5ES-11	4424
WR8DCX+	BPR5ES-11	4424
WR8DP	BPR5ES	7422
WR8DPX	BPR5ES-11	4424
WR8DS	BPR5EIX	6597
WR8E	BR6S	3522
WR8EC	BR6S	3522
WR8EP	BR6S	3522

À TITRE INDICATIF

BOSCH	NGK	N° STOCK
WR8F	BP5S	3011
WR8FC	BP5S	3011
WR8FP	BP5S	3011
WR9AO	BR5HS	3722
WR9C	BR5ES	4722
WR9CC	BR5ES	4722
WR9D	BPR5ES	7422
WR9D+	BPR5ES	7422
WR9DC	BPR5ES	7422
WR9DC+	BPR5ES	7422
WR9DCX	BPR5ES-11	4424
WR9DCX+	BPR5ES-11	4424
WR9DCY	BPR5ES-13	3154
WR9DP	BPR5ES	7422
WR9DPX	BPR5ES-11	4424
WR9DS	BPR5EIX	6597
WR9DY	BPR5ES-13	3154
WR9E	BR6S	3522
WR9EC	BR6S	3522
WR9EO	BR6S	3522
WR9FP	BP5S	3011
WR10A	BR4HS	3322
WR10AC	BR4HS	3322
WR10DC	BPR4ES	7222
WR10E	BR6S	3522
WR10FCZ	XR4	5858
WR11E	BR2-LM	5798
WR11EO	BR4-LM	4133
WR11F	BP-4	2911
WR78	BPR6ES	7822
WR240T1	BR8HS	4322
WS5E	BM7A	6521
WS5F	BPM7A	7321
WS6E	BM6A	5921
WS6F	BPM6A	7021
WS7E	BM6A	5921
WS7F	BPM6A	7021
WS8E	BM6A	5921
WS8F	BPM6A	7021
WSR5E	BMR7A	4226
WSR5F	BPMR7A	4626
WSR7F	BPMR6A	6726
WSR8E	BMR6A	7421
WSR8F	BPMR6A	6726
WSR9E	BMR4A	5728
WSR9EC	BMR4A	5728
X3CPO	D9EA	2420
X4CC	D8EA	2120
X4CS	D8EA	2120
X4DC	D8EA	2120
X5CC	D8EA	2120
X175T1	D5HS	6212
X260T1	D6HA	6512
X260T2	D6EA	7512
X300T1	D8HA	7112
X300T2	D9EA	2420
XR2AS	DR8HS	5123
XR4AS	DR8HS	5123
XR5CC	DR8EA	7162
XR6CC	DR7EA	7839
XR7CC	DR7EA	7839
XR7DC	DR7EA	7839
Y5DDC	DCPR8EKP	7415
YR5DDE	KR9CI	7795
YR6LDE	DCPR8EKC	7168
YR6LDE	DCPR8EKC	7168
YR7DE	DCPR8E-N	5692
YR7NE	LKR7B-9	5847

BRIGGS & STRATTON	NGK	N° STOCK
499 950	BCP5ES	7496
690 983	BCP5ES	7496

BRISK	NGK	N° STOCK
77-301-1	B2-LM	1147
77-302-1	BM6A	5921
77-303-1	BCPR5ES	6130
77-304-1	BM6F	6221
77-305-1	BR2-LM	5798
77-306-1	BMR6A	7421
77-307-1	BPMR7A	4626
77-308-1	BM7A	6521
77-310-1	BP5ES	6511
77-311-1	BPM7A	7321
77-312-1	BPR6ES	7822
77-313-1	B4-LM	3410
77-315-1	BP6ES	7811
77-325-1	BPR6HS	7022
77-350-1	BR4-LM	4133
77-351-1	B6S	3510
77-352-1	BP5HS	4111
B12YC	DP9EA-9	6629
B14YC	DP8EA-9	5829
B15YC	DP7EA-9	5629
D12YC	BCP7ES	5030
D14YC	BCP7ES	5030
D15Y	BKR6E	6962
D15YC	BCP6ES	4930
D17YC	BCP5ES	7496
DOX15LE-1	ZFR6T-11G	5960
DR12YC	BKR7E	6097
DR14ZC	ZFR7F-11	2975
DR14ZC-1	BCPR7ES-11	1095
DR15TC	BKUR5ET-10	7553
DR15YC	BKR6E	6962
DR15Z	BKR6E	6962
G12YC	BP7EFS	3526
G14Y	BP7EFS	3526
G14YC	BP7EFS	3526
G15Y	BP6EFS	3812
G15YC	BP6EFS	3812
G17Y	BP5EFS	3712
G17YC	BP5EFS	3712
GR15YC	BPR6EFS	3623
GR17YC	BPR5EFS	2223
J17	B4-LM	3410
J19	B2-LM	1147
JR17	BR4-LM	4133
JR19	BR2-LM	5798
K15YC	BP6S	3111
K17C	B6S	3510
K17Y	BP5S	3011
L08JW	B10EGV	5927
L08W	B11EGV	5831
L10JW	B8EGV	5627
L12W	BR9EIX	3981
L14	B8ES	2411
L14C	B8ES	2411
L14YC	BP7ES	2412
L15	B7ES	1111
L15C	B7ES	1111
L15Y	BP6ES	7811
L15YC	BP6ES	7811
L17	B6ES	7310
L17C	B6ES	7310
L17W	BR7EIX	6664
L17Y	BP5ES	6511
L17YC	BP5ES	6511
L19	B4ES	4129
L19C	B5ES	6410
LR12YC	BPR8ES	3923
LR12ZC	BPR8ES	3923
LR14YC	BPR7ES	2023
LR14ZC	BPR7ES	2023
LR14ZC-1	BPR7ES-11	7226
LR15YC	BPR6ES	7822

LR15Z	BPR6ES	7822
LR15Z-1	BPR6ES-11	4824
N08W	BR10HIX	6692
N12W	BR9HIX	5687
N12Y	BP8HS	2630
N12YC	BP8HS	2630
N14	B8HS	5510
N14YC	BP7HS	5111
N15C	B7HS	5110
N15W	BR8HIX	7001
N15Y	BP6HS	4511
N15YC	BP6HS	4511
N17W	BR7HIX	7067
N17YC	BP5HS	4111
N19	B5HS	4210
N19C	B5HS	4210
NR12YC	BPR8HS	3725
NR15YC	BPR6HS	7022
P15	BM7A	6521
P15Y	BPM7A	7321
P17	BM6A	5921
PR15Y	BPMR7A	4626
PR17	BMR6A	7421
U15	BM7F	6421
U17	BM6F	6221
UR17	BMR6F	2144

CARLTON	NGK	N° STOCK
71010	BM7F	6421
71015	BM6F	6221
71020	BM7A	6521
71025	BPM7A	7321
71030	BM7A	6521
71035	BPM7A	7321
71040	BM6A	5921
71045	BPM6A	7021
71050	B6HS	4510
71055	B5HS	4210
71060	B-4	3210
71065	B-4H	4110
71070	BPMR6A	6726
71075	B4-LM	3410
71080	B2-LM	1147
71085	BR4-LM	4133
71090	BR2-LM	5798
71095	B6S	3510
71100	BPR5ES	7422
71105	BKR5E-11	6953
71110	BPR4ES	7222
71115	BP5HS	4111
71120	CR7HSA	4549
C7S	B6HS	4510
C8S	B5HS	4210
C9	B-4	3210
C10S	B-4H	4110
CA5E	BM7A	6521
CA5Y	BPM7A	7321
CA6	BPMR6A	6726
CA7E	BM7A	6521
CA7Y	BPM7A	7321
CABE	BM6A	5921
CABY	BPM6A	7021
CN8E	BM7F	6421
CN8E	BM6F	6221
L17A	B4-LM	3410
L19A	B2-LM	1147
LR17A	BR4-LM	4133
LR19A	BR2-LM	5798
SR6D	BPMR6A	6726

CASE	NGK	N° STOCK
MM431439	Y-142T	5473

CHAMPION	NGK	N° STOCK
2071	BCPR5ES	6130
2301	BPR5ES-11	4424
2322	BPR4ES-11	4224
2332	BPR6ES	7822
2338	BKR6ES	3783
2415	BPR5ES	7422
2430	BKR5E-11	6953
3071	BKR5EP-11	3440
3322	BPR5EIX-11	2115
3344	BKR6EIX-11	3764
3407	TR5-1IX	7243
5828	BZ7HS-10	3579
5838	BUZHW-2	2173
5843	BM7A	6521
5846	BM6A	5921
5847	BM6F	6221
5861	B2-LM	1147
5898	BUZHW	2147
5931	BR6HS	3922
5933	B6HS	4510
5939	BPR7HS	6422
5942	BPR4FS-11	2527
7712	PZFR6H	7696
88091	DPR7EA-9	5129
9202064	BKR6EKUB	3584
A2HC	DPR9EA-9	5329
A4HC	DP9EA-9	6629
A5YC	DP9EA-9	6629
A6	D8EA	2120
A6G	DR8EIX	6681
A6Y	DP8EA-9	5829
A6YC	DP8EA-9	5829
A8	D7EA	7912
A8Y	DP7EA-9	5629
A8YC	DP7EA-9	5629
A10	D7EA	7912
A26	AB-6	2910
A57C	DR9EIX	4772
A59G	DR9EIX	4772
A59GC	DCPR9EIX	2316
A61	D9EA	2420
A61G	DR9EIX	4772
A65	AB-6	2910
BL4	B7FS	3027
BL5	B7FS	3027
BL6	BR6FS	4323
BL7Y	BP7FS	3612
BL8	BR6FS	4323
BL9Y	BP6FS	3512
BL11Y	BP5FS	3412
BL13Y	BP5FS	3412
BN2	B9EFS	1085
BN6Y	BP7EFS	3526
BN7Y	BP6EFS	3812
BN9Y	BP6EFS	3812
BN12Y	BP5EFS	3712
BN89Y	BP6EFS	3812
C6BYC	BCP7ET	2078
C6VPYC	BKR7EIX-11	6988
C6YCC	BCP7ES	5030
C7Y	BCP7ES	5030
C7YC	BCP7ES	5030
C7YCC	BCP7ES	5030
C7YCX	BCP7ES	5030
C9MCC	ZFR5F	5165
C9YCC	BCP6ES	4930
C9YCX	BCP6ES	4930
C10YCC	BCP6ES	4930
C12YC	BKR5E	7938
C12YCC	BK5E	6233
C281YC	BCP6ES	4930
CH 128	Y-162R1	2431

À TITRE INDICATIF

CH 137	Y-924J	7906
CH 144	Y-110	6825
CH 159	Y-924J	7906
CH 162	Y-707RS	4937
CH 163	Y-924J	7906
CH 164	Y-924J	7906
CH 174	Y-924J	7906
CH 189	Y-924J	7906
CH 65	Y-810	6929
CH 88	Y-924J	7906
CJ3	BM7A	6521
CJ4	BM7A	6521
CJ6	BM7A	6521
CJ6Y	BPM7A	7321
CJ7Y	BPM7A	7321
CJ8	BM6A	5921
CJ8Y	BPM6A	7021
CJ11	BM6A	5921
CJ14	BM4A	5628
CJ17LM	B4-LM	3410
CJ86	BM6A	5921
D6	AB-8	7909
D9	AB-6	2910
D9J	AB-6	2910
D9JM	AB-7	3010
D10	AB-6	2910
D14	AB-6	2910
D16	AB-6	2910
D16J	AB-6	2910
D21	AB-6	2910
D23	AB-6	2910
DJ6J	BM7F	6421
DJ6Y	BPM7F	1268
DJ7J	BM6F	6221
DJ7Y	BPM6F	5950
DJ8J	BM6F	6221
FN507Y	BCP7ES	5030
H03	B6S	3510
H8	B-6L	3212
H8C	B-6L	3212
H8J	B-6L	3212
H10	B-6L	3212
H10C	B-6L	3212
H10J	B-6L	3212
H11	B-4L	3112
H12	B-4L	3112
J4	B7S	3710
J4C	B7S	3710
J4J	B7S	3710
J5	B7S	3710
J6	B6S	3510
J6C	B6S	3510
J6J	B6S	3510
J7	B6S	3510
J7J	B6S	3510
J8	B6S	3510
J8C	B6S	3510
J8J	B6S	3510
J8S	B6S	3510
J10Y	BP6S	3111
J11	B-4	3210
J11C	B-4	3210
J11J	B-4	3210
J11Y	BP5S	3011
J12J	B-2	3110
J12Y	BP5S	3011
J12YC	BP5S	3011
J13Y	BP5S	3011
J14	B-2	3110
J14J	B-2	3110
J14Y	BP5S	3011
J14YC	BP5S	3011
J17LM	B4-LM	3410
J18Y	BP-4	2911

J18YC	BP-4	2911
J19LM	B2-LM	1147
K3G	AB-8	7909
K5G	AB-8	7909
K7	AB-8	7909
K8	AB-8	7909
K8G	AB-8	7909
K9	AB-7	3010
K13	AB-6	2910
K15J	AB-6	2910
KCJ6	BM7A	6521
KCJ7Y	BPM7A	7321
KJ12	BR6S	3522
L2G	BR9HIX	5687
L3G	BR8HIX	7001
L4G	BR7HIX	7067
L4J	B7HS	5110
L5	B7HS	5110
L6G	BR7HIX	7067
L6VC	BU8H	6431
L7	B6HS	4510
L7J	B6HS	4510
L9G	BR6HIX	3419
L9J	B6HS	4510
L10S	B-6L	3212
L11S	B7HS	5110
L12Y	BP5HS	4111
L14	B-4H	4110
L15Y	BP4HS	3611
L19V	BUH	2422
L20V	BUH	2422
L288	B5HS	4210
L55G	BR10HIX	6692
L60R	B-6L	3212
L61Y	BP8HS	2630
L64Y	BP7HS	5111
L66Y	BP6HS	4511
L76V	BUHW	2622
L77J	B7HS	5110
L77J4	B7HS-10	2129
L77JC	B7HS	5110
L77JC4	B7HS-10	2129
L77V	BUHW	2622
L78	B7HS	5110
L78C	B7HS	5110
L78V	BUHW-2	5626
L78YC	BP7HS-10	7829
L78YC6	BP8HS-15	6729
L81	B7HS	5110
L81Y	BP7HS	5111
L82	B6HS	4510
L82C	B6HS	4510
L82Y	BP6HS	4511
L82YC	BP6HS	4511
L82YCC	BP6HS	4511
L85	B6HS	4510
L85Y	BP6HS	4511
L86	B6HS	4510
L86C	B6HS	4510
L86CC	B6HS	4510
L87Y	BP6HS	4511
L87YC	BP6HS	4511
L87YCC	BP6HS	4511
L88A	B6HS	4510
L89CM	BP5HS	4111
L90	B5HS	4210
L90C	B5HS	4210
L92LCC	BP5HA	7426
L92Y	BP5HS	4111
L92YC	BP5HS	4111
L92YC4	BP5HS-10	7429
L95Y	BP4HS	3611
N1	B10ES	7928
N1C	B10ES	7928

N2	B9ES	2611
N2C	B9ES	2611
N2G	BR9EIX	3981
N3	B8ES	2411
N3C	B8ES	2411
N3G	BR8EIX	5044
N4	B7ES	1111
N4C	B7ES	1111
N4G	BR7EIX	6664
N4YC	BP9ES	7526
N5	B6ES	7310
N5C	B6ES	7310
N6	B6ES	7310
N6GY	BPR8EIX	6684
N7	B7ES	1111
N7GY	BPR7EIX	4055
N7Y	BP7ES	2412
N7YC	BP7ES	2412
N7YCC	BP7ES	2412
N7YCX	BP7ES	2412
N8	B6ES	7310
N8GY	BPR6EIX	6637
N8Y	BP6ES	7811
N9BMC	BPR5EIKU	5685
N9Y	BP6ES	7811
N9YC	BP6ES	7811
N9YC4	BP6ES-11	1212
N9YCC	BP6ES	7811
N9YCE	BP5ES	6511
N9YCX	BP6ES	7811
N10PY	BPR6EIX	6637
N10Y	BP6ES	7811
N10Y4	BP6ES-11	1212
N10YC	BP5ES	6511
N11Y	BP5ES	6511
N11YC	BP5ES	6511
N11YC4	BP5ES-11	7311
N11YCC	BP5ES	6511
N12Y	BP5ES	6511
N12YC	BP5ES	6511
N12YCC	BP5ES	6511
N13Y	BP5ES	6511
N14Y	BP5ES	6511
N16Y	BP4ES	6928
N16YC	BP4ES	6928
N19V	BUE	2322
N21	B4ES	4129
N54R	B10EG	3630
N55G	B105EGV	2171
N56R	B105EGP	2077
N57	B10ES	7928
N57G	B105EGV	2171
N57R	B10EG	3630
N59G	B95EGV	2145
N60	B9ES	2611
N60R	B8EG	3430
N62R	B8EG	3430
N63Y	BP9ES	7526
N65Y	BP7ES	2412
N66Y	BP6ES	7811
N74C	BUR6EB-11	5730
N79Y	BP6ES	7811
N80	B10EG	3630
N80G	B11EGV	5831
N82	B10EG	3630
N82G	B105EGV	2171
N84	B9EG	3530
N84G	B95EGV	2145
N86	B9EG	3530
N86G	B9EGV	5827
N87	B8EG	3430
N87G	B8EGV	5627
N89GY	BP6ES	7811
N89Y	BP5ES	6511

N92Y	BP4ES	6928
N178B	BR8EM	7449
N180B	B7EM	3321
N279YC	BP7ES	2412
N281YC	BP6ES	7811
N288	B5ES	6410
NA8	B6ES	7310
OBL9Y	BPR6FS	2623
OJ11Y	BP6S	3111
OJ12Y	BP5S	3011
OJ13Y	BP5S	3011
ON3	BR8ES	5422
ON11Y	BPR5ES	7422
ON12Y	BPR5ES	7422
P7	D8HA	7112
P7G	DR8HS	5123
P7Y	D8HA	7112
P8Y	D6HA	6512
P10Y	D6HA	6512
PA5HC	D7EA	7912
PA7HC	D7EA	7912
PL7YC4	BP6HS-10	6326
PL9YC	BP6HS	4511
PN5C	B8ES	2411
PRA7HC	DR7EA	7839
PRG7C	CR7E	4578
PRL5SC	BR6HSA	4296
PRL9SC	BR4HSA	2751
PRZ9HC	CR7HSA	4549
PZ7HC	C7HSA	4629
PZ9HC	C6HSA	3228
QCJ8Y	BPMR6A	6726
QC10PEP	IZFR6N-E	4757
QC10PEPB	IZFR6N-E	4757
QC10WEP	IZFR6N-E	4757
QC12PEP	PZFR6H	7696
QC12PEPB	IZFR6N-E	4757
QC12YC	BKR5ES	2460
QJ17LM	BR4-LM	4133
QL6VC	BU8H	6431
QL7J5	BR6HS	3922
QL16V	BUZ8H	7447
QL76V	BUZHW	2147
QL77J4	BZ7HS-10	3579
QL77JC4	BZ7HS-10	3579
QL78C	BR7HS	4122
QL78V	BUZHW-2	2173
QL81Y	BPR7HS-10	1092
QL82C	BR6HS	3922
QL82YC	BPR6HS	7022
QL86	BR6HS	3922
QL86C	BR6HS	3922
QL87YC	BPR6HS	7022
QL92LCC	BP8HS-10	3823
QN2	BR9ES	5722
QN2C	BR9ES	5722
QN2G	BR9EIX	3981
QN3	BR8ES	5422
QN3C	BR8ES	5422
QN84	BR9EG	3230
QN86	BR8EG	3130
R6	D8EA	2120
R6G	DR8EIX	6681
R6J	D8EA	2120
R8	D7EA	7912
R10	D6EA	7512
R41CXLS	BPR8ES	3923
R43LTS	BPR6EFS	3623
R43TSK	UR5	2771
R44CXLS	BPR5ES	7422
R44NS	BPR5ES	7422
RA4HC	DCPR8E	4339
RA4HCC	DCPR8E	4339
RA6HC	DCPR8E	4339

À TITRE INDICATIF

CHAMPION	NGK	N° STOCK
RA7YC	DCPR8E	4339
RA8GHC	DCPR6E	3481
RA8Y	DPR7EA-9	5129
RA8YC	DPR7EA-9	5129
RA59GC	DCPR9EIX	2316
RA59PP	DCPR9EIX	2316
RA606YC	DCPR7E	3932
RAX92C	DR9EA	3437
RAX92DC	JR9C	6193
RAX94C	DR8EA	7162
RAX96C	DR7EA	7839
RAX96YC	DPR7EA-9	5129
RBL8	BR6FS	4323
RBL8-6	BR6FS	4323
RBL9Y	BPR6FS	2623
RBL11Y	BPR5FS	2423
RBL11Y6	BPR5FS-15	3124
RBL12	BR5FS	4123
RBL12-6	BR5FS	4123
RBL13Y	BPR5FS	2423
RBL13Y6	BPR5FS-15	3124
RBL15Y	BPR4FS	1127
RBL15Y4	BPR4FS-11	2527
RBL15Y6	BPR4FS-15	2727
RBL16Y	BPR4FS	1127
RBL17Y	BPR4FS	1127
RBL17Y6	BPR4FS-15	2727
RBN12Y	BPR5EFS	2223
RBN13Y	BPR5EFS	2223
RBN14Y	BPR5EFS	2223
RBN9Y	BPR6EFS	3623
RC6VPYC	BKR7EIX-11	6988
RC6YC	BCPR7E	1272
RC6YCC	BCPR7ES	3330
RC7BYC4	BCPR6ET	2197
RC7GYG	BKR6EIX	6418
RC7YC3	BKR7E	6097
RC7YC4	BKR7E-11	1283
RC7YCC	BCPR7ES	3330
RC7YCC4	BKR7E-11	1283
RC8BYC	BKR6EKC	2848
RC8MCC4	ZFR5J-11	5584
RC8TYC	BKR6EKPA	2513
RC8WMP2	IZFR6B	3116
RC8YCC4	BKR6E-11	2756
RC8YCL	BKR6EZ	4619
RC9BMC	BKR5EKU	3964
RC9MC4	ZFR5F-11	2262
RC9TMC	BKR6EKUB	3584
RC9Y	BKR6E	6962
RC9YC	BKR6E	6962
RC9YC4	BKR6E-11	2756
RC9YC5	BKR6E-11	2756
RC9YCC	BKR6ES	3783
RC9YCN4	BKR6E-11	2756
RC10PYC	BKR6EIX	6418
RC10WMP2	IZFR5B	4080
RC10YCC4	BKR6E-11	2756
RC10YCL	BKR5EZ	7642
RC12LC	ZFR5F	5165
RC12MC5	ZFR5F-11	2262
RC12MCC4	ZFR5F-11	2262
RC12YC	BKR5ES	2460
RC12YCC	BKR5E	7938
RC12YCC4	BKR5ES-11	2382
RC14YC	BKR5E	7938
RC14YC4	BKR5E-11	6953
RC14YCC4	BKR5ES-11	2382
RC87YC	BKR6ES	3783
RC87YCL	BKR6EZ	4619
RC89PYC	BKR6EIX	6418
RCJ4	BMR7A	4226

RCJ6	BMR7A	4226
RCJ6Y	BPMR7A	4626
RCJ7Y	BPMR7A	4626
RCJ8	BMR6A	7421
RCJ8Y	BPMR6A	6726
RCJ501H	BPMR4A	6028
RD9	AB-6	2910
RD14	AB-6	2910
RD16	AB-6	2910
RDJ7J	BMR6F	2144
RDJ7Y	BPMR6F	1270
RDJ8J	BMR6F	2144
RE10PMCC5	LZTR4A-11	5444
RE10YC4	BKR5ES-11	2382
RE14MCC5	LZTR4A-11	5444
REC10YC4	LFRA5-11	6376
RF14LC	WR4-1	4652
RG4HC	CR9E	6263
RG6YC	CPR8E	7411
RG6YCA	CPR8E	7411
RG6YCH	CPR8E	7411
RG92C	CR9E	6263
RG92DC	CR9EK	4548
RG94C	CR8E	1275
RGU92C	CR9EH-9	7502
RGU94C	CR8EH-9	5666
RH10C	B-6L	3212
RH18Y	B-4L	3112
RJ2YLE	BPMR6A	6726
RJ6	BR6S	3522
RJ6C	BR6S	3522
RJ6J	BR6S	3522
RJ7	BR6S	3522
RJ8	BR6S	3522
RJ8C	BR6S	3522
RJ8J	BR6S	3522
RJ10Y	BP6S	3111
RJ11	BR6S	3522
RJ11Y	BP5S	3011
RJ12	BR6S	3522
RJ12C	BR6S	3522
RJ12Y	BP5S	3011
RJ12YC	BP5S	3011
RJ14CC	XR4	5858
RJ14Y	BP5S	3011
RJ14YC	BP5S	3011
RJ17LM	BR4-LM	4133
RJ18YC6	XR45IX	7293
RJ19LM	BR2-LM	5798
RJ20Y	BP-4	2911
RL4J	BR7HS	4122
RL7J	BR6HS	3922
RL12Y	BPR6HS	7022
RL19	BR5HS	3722
RL77J	BR7HS	4122
RL78	BR7HS	4122
RL78C	BR7HS	4122
RL82	BR6HS	3922
RL82C	BR6HS	3922
RL82Y	BPR6HS	7022
RL82YC	BPR6HS	7022
RL82YCC	BPR6HS	7022
RL83C	BR6HS	3922
RL85	BR6HS	3922
RL85C	BR6HS	3922
RL86	BR6HS	3922
RL86C	BR6HS	3922
RL87Y	BPR6HS	7022
RL87YC	BPR6HS	7022
RL90	BR5HS	3722
RN1C	BR10ES	4832
RN2	BR9ES	5722
RN2C	BR9ES	5722
RN2G	BR9EIX	3981

RN3	BR8ES	5422
RN3C	BR8ES	5422
RN3G	BR8EIX	5044
RN4	BR7ES	5122
RN4C	BR7ES	5122
RN4Y	BPR8ES	3923
RN4YC	BPR8ES	3923
RN5	BR6ES	4922
RN5C	BR6ES	4922
RN6	BR6ES	4922
RN6Y	BPR8ES	3923
RN6YC	BPR8ES	3923
RN7GY	BPR7EIX	4055
RN7LCC	BPR5E	7075
RN7Y	BPR7ES	2023
RN7YC	BPR7ES	2023
RN7YC4	BPR7ES-11	7226
RN7YCC	BPR7ES	2023
RN7YCC4	BPR7ES-11	7226
RN8	BR5ES	4722
RN9BMC	BPR5EKU	5685
RN9GY	BPR6EIX	6637
RN9Y	BPR6ES	7822
RN9YC	BPR6ES	7822
RN9YC4	BPR6ES-11	4824
RN9YCC	BPR6ES	7822
RN9YCC4	BPR6ES-11	4824
RN10GY	BPR6EIX	6637
RN10TYC4	BUR5ET-10	7264
RN10Y	BPR6ES	7822
RN10Y4	BPR6ES-11	4824
RN10YC	BPR6ES	7822
RN10YC4	BPR6ES-11	4824
RN11C	BPR5ES	7422
RN11Y	BPR5ES	7422
RN11YC	BPR5ES	7422
RN11YC4	BPR5ES-11	4424
RN11YCC	BPR5ES	7422
RN11YCC4	BPR5ES-11	4424
RN12GY	BPR5EIX	6597
RN12MC4	BPR4EY-11	1143
RN12Y	BPR5ES	7422
RN12YC	BPR5ES	7422
RN12YC4	BPR5ES-11	4424
RN12YC6	BPR5ES-13	3154
RN12YCC	BPR5ES	7422
RN14MC5	BPR4EY-11	1143
RN14Y	BPR5ES	7422
RN14Y6	BPR5ES-13	3154
RN16Y	BPR4ES	7222
RN57YCC	BR10EG	3830
RN74C	BUR6EB-11	5730
RN180B	BR7EM	3821
RP10HC	DR5HS	4623
RP7	DR8HS	5123
RS5C	BR7EFS	1094
RS6YCC	BP7EFS	3526
RS9YC	BPR6EFS	3623
RS9YCC	BPR6EFS	3623
RS10LC	TR5-1	7060
RS12PYP	TR5IX	7397
RS12YC	BPR5EFS	2223
RS12YC6	BPR5EFS-13	2359
RS13LYC	TR4	3754
RS14LC	TR5-1	7060
RS14LYC	TR4	3754
RS14PYP	TR4IX	7300
RS14YC	BPR5EFS	2223
RS15LYC	TR4	3754
RS16YC	TR4	3754
RS17YX	TR4	3754
RV8C	BR6FS	4323
RV8C6	BR6FS	4323
RV91MC	BR6FS	4323

RV92YC	BPR5FS	2423
RV9YC	BPR6FS	2623
RV12C	BR5FS	4123
RV12C6	BR5FS	4123
RV12YC	BPR5FS	2423
RV12YC6	BPR5FS-15	3124
RV15YC	BPR4FS	1127
RV15YC4	BPR4FS-11	2527
RV15YC6	BPR4FS-15	2727
RV17YC	BPR4FS	1127
RV17YC6	BPR4FS-15	2727
RV19YC	BPR4FS	1127
RZ7C	CMR7H	3066
RZ94C	CR8HSA	2086
RZ96C	CR7HSA	4549
RZN12Y	BPR5EFS	2223
RZN12Y5	BPR5EFS	2223
S6YC	BP7EFS	3526
S6YCC	BP7EFS	3526
S7YC	BP7EFS	3526
S7YCC	BP7EFS	3526
S9YC	BP6EFS	3812
S9YCC	BP6EFS	3812
S10YCC	BP5EFS	3712
S12YC	BP5EFS	3712
S279YC	BP6EFS	3812
S281YC	BP6EFS	3812
S379YC	BP7EFS	3526
UD16	AB-6	2910
UJ2J	B8S	3810
UJ4J	B7S	3710
UJ6	B6S	3510
UJ8	B6S	3510
UJ12	B-2	3110
UJ81C	B7S	3710
UJ81J	B7S	3710
UK10	AB-6	2910
UL4J	B7HS	5110
UL17V	BUHXW-1	5526
UL18V	BUHX	2522
UL77V	BUHXW-1	5526
UL81C	B7HS	5110
UL81J	B7HS	5110
UL82Y	BP7HS	5111
UN12Y	BP5ES	6511
UN19V	BUE	2322
UN79Y	BP6ES	7811
V4C	B7FS	3027
V9YC	BP6FS	3512
V12YC	BP5FS	3412
XC12PEPB	PZFR6H	7696
XC92YC	BKR5E	7938
XG4YCX	MR7F	95897
XJ4J	B7S	3710
XJ8	BR6S	3522
XJ10Y	BP6S	3111
XL10	BR6HS	3922
XN-8	BR6ES	4922
Y82	CM-6	5812
Z6	C8HSA	6821
Z7G	CR7HIX	7544
Z8	C7HSA	4629
Z9Y	C7HSA	4629
Z10	C6HSA	3228
Z10G	CR7HIX	7544
Z12	C6HSA	3228

DENSO	NGK	N° STOCK
3004	BPR5EP-11	3971
3006	BCPR5EY-11	4120
3007	BCPR6E	1269
3008	BCPR6E-11	3132
3009	BCPR6EY-11	3720
3010	BCPR7ES	3330

À TITRE INDICATIF

3011	BP4EY	1028	3186	BCPR5EY-11	4120	4033	BR8ES	5422	5026	BPR5FS-11	2924
3013	BPR4EY	2128	3187	BCPR6EY-11	3720	4034	B8EG	3430	5027	BPR5FS-15	3124
3018	BP5ES	6511	3191	BKR5E	7938	4037	BR8HS	4322	5029	BR5FS	4123
3021	BPR5ES	7422	3192	BKR7E-11	1283	4038	B8HS	5510	5030	BR5FS	4123
3025	B5ES	6410	3194	BKR5EKB-11	3967	4039	BR8HIX	7001	5031	BP6EFS	3812
3027	BP5EY	7327	3195	BKR6EKB-11	3583	4040	B8S	3810	5032	BPR6EFS	3623
3031	BPR5EY	2828	3199	BP5EY-11	4028	4045	BR9ES	5722	5034	BP6FS	3512
3032	BPR5EY-11	3028	3201	BPR5ES-11	4424	4046	B9ES	2611	5035	BPR6FS	2623
3033	BR5HS	3722	3210	BPR5EY	2828	4047	B9EG	3530	5038	BR6FS	4323
3034	B5HS	4210	3213	BPR5ES-13	3154	4048	B9EGV	5827	5040	BP7EFS	3526
3035	B-6L	3212	3223	BCPR6EP-N-8	5275	4052	B9HS	5810	5066	BP7ET	3684
3036	BP5S	3011	3226	BKR6EP-13	2550	4053	BR9HIX	5687	5069	BCP7ET	2078
3043	BP6ES	7811	3231	BPR5EIX	6597	4054	BR9HS	4522	5077	PZTR5A-15	7862
3045	BPR6EIX	6637	3235	BCRE527Y	2074	4057	B95EGV	2145	5302	BCPR6EIX-11	4919
3046	BUR6EA-11	5428	3239	BPR5EP-11	3971	4063	B10EGV	5927	5303	BKR5EIX-11	5464
3047	BPR6ES	7822	3242	DCPR7EIX	6046	4067	BR10HIX	6692	5304	BKR6EIX-11	3764
3049	BPR6ES-11	4824	3244	BCPR6EIX-11	4919	4075	DR5HS	4623	5305	BPR5EIX-11	2115
3051	B6ES	7310	3249	BKR7EKC-N	2095	4078	D6HA	6512	5306	BPR6EIX-11	3903
3054	BR6ES	4922	3253	BKR6EKP-11	3452	4080	DR6HS	4823	5307	BPR7EIX	4055
3056	BR6ES	4922	3255	BCP7ES	5030	4086	DCPR7EA-9	5129	5308	DCPR7EIX	6046
3057	BR6ES	4922	3256	ZGR5A	5839	4090	D7EA	7912	5309	DCPR8EIX	6546
3062	BP6EY	7727	3257	BCPR7ES-11	1095	4091	DR7ES	3123	5310	BKR7EIX	2667
3066	BPR6EY	6427	3262	BKR6EIX-11	3764	4093	DPR8EA-9	4929	5311	BKR8EIX	2668
3067	BPR6EY-11	4228	3264	PFR5B-11	2300	4096	DPR8EA-9	4929	5312	BKR9EIX	2669
3068	BP6HS	4511	3265	PFR7G-11S	7772	4097	DPR8EIX-9	2202	5316	BR8EIX	5044
3070	BPR6HS	7022	3273	PFR7B	4853	4099	D8EA	2120	5317	BR9EIX	3981
3073	B6HS	4510	3275	PFR5G-11	2647	4101	DR8ES-L	2923	5319	BR10EIX	6801
3074	BR6HIX	3419	3276	BK6E	3536	4103	D8HA	7112	5325	TR5IX	7397
3075	B6S	3510	3277	BPR6EKN	1128	4105	DR8HS	5123	5327	TR7IX	3690
3076	BR6S	3522	3281	BPR7EIX	4055	4106	DPR8Z	4730	5328	TR8IX	3691
3081	BR7ET	4121	3285	BPR5EIX-11	2115	4111	DPR9EA-9	5329	5330	UR5IX	7177
3082	BR7ET	4121	3289	BKR5EKP-11	4302	4114	D9EA	2420	5331	UR6IX	7348
3085	BP7ES	2412	3290	BKR7EIX	2667	4116	DR8ES	5423	5336	FR9BI-11	4709
3086	BPR7EIX	4055	3291	BPR6EIX	6637	4117	DPR9Z	4830	5337	DCPR9EIX	2316
3088	BPR7ES	2023	3293	BKR5EIX	6341	4123	B11EGV	5831	5348	BKR7EIX	2667
3089	BPR7ES-11	7226	3299	BKR7E-N-11	6256	4126	CR8E	1275	5349	LZTR5AIX-13	2314
3093	B7ES	1111	3304	BKR6EKC	2848	4127	CR8EH-9	5666	5351	BKR5EIX-11	5464
3095	BR7EIX	6664	3310	BR10ET	7480	4129	CR9EH-9	7502	5352	BKR6EIX-11	3764
3098	BR7ES	5122	3312	DCPR8E	4339	4131	CR9E	6263	5361	CR7EIX	7385
3102	BR8ET	4221	3313	DCPR9E	2641	4135	CR10EK	2360	5362	CR8EIX	4218
3103	BR8ET	4221	3314	DCPR9EIX	2316	4136	BPR8ES	3923	5363	CR9EIX	3521
3107	BR9ET	4528	3322	BCPR6EIX-11	4919	4155	CR9EK	4548	5368	CR8EHIX-9	3797
3110	BR5ES	4722	3323	BPR6EIX-11	3903	4158	CR8EK	3478	5369	CR9EHIX-9	6216
3113	BCPR6EP-N-8	5275	3329	BKR5EKC	5216	4159	BR9ECM	3252	5372	DR8EIX	6681
3117	BCPR6EP-11	3350	3333	BKR6E	6962	4160	BR10ECS	5880	5373	DR9EIX	4772
3119	BKR5EYA	2087	3344	BPR6ES	7822	4161	BPR6HSA	4632	5375	DPR7EIX-9	7803
3120	BKR5EYA-11	2526	3345	BPR5ES	7422	4162	ER9EH	5869	5376	DPR8EIX-9	2202
3121	BKR6E-11	2756	3346	BCPR5E	1145	4167	DR8EIX	6681	5377	DPR9EIX-9	5545
3122	BKR6EYA	2249	3347	BCPR7ES	3330	4168	BP7HS-10	7829	5378	BPR6HIX	4085
3123	BCPR5EP-8	2950	3349	BKR5E	7938	4169	CR10EIX	6482	5379	BR7HIX	7067
3125	BCP6ES	4930	3373	BKR6EP-8	2215	4172	DR9EIX	4772	5380	BR8HIX	7001
3127	BKR6EP-8	2215	3379	BCPR7ES-11	1095	4174	CR7E	4578	5383	CR7HIX	7544
3128	BKR6EP-11	2978	3380	BKR6EKPA	2513	4175	BR8EIX	5044	5384	CR8HIX	7669
3129	BCPR5EY	1266	3398	BKR6EIX-11P	2574	4176	BR10ES	4832	5388	CR9EHI-9	6419
3130	BKR5E-11	6953	3424	BKR6E	6962	4178	BP8HS	2630	5390	CR9EIA-9	6289
3134	BKR5EP-11	3440	4002	C6HSA	3228	4185	ER8EH	4011	5601	BCPR5EIX-11P	3215
3137	BCPR5E	1145	4004	CR6HSA	2983	4186	ER10EH	2862	5602	BCPR6EIX-11P	4174
3140	BCPR6EY	1146	4006	C7HSA	4629	4187	CR10E	6264	5607	BPR7EIX	4055
3141	PFR6J-11	2743	4008	CR7HSA	4549	4188	BPR8HS	3725	5608	DCPR7EIX-P	5175
3142	PFR6G-11	5555	4009	C8HSA	6821	4189	CR8EIX	4218	5614	IJR7A9	7901
3144	BKR6E-N-11	5724	4012	B-4H	4110	4191	CR9EIX	3521	5615	IFR6L11	3678
3145	BKR6E	6962	4014	BP4HS	3611	4192	BPR5HS	6222	5616	IFR8H11	5068
3156	BCPR5EIX-11	3306	4017	BR4HS	3322	4201	CR7EK	7546	5628	IFR5L11	6502
3158	BCPR7EIX	5690	4018	BPR5EIX-11	2115	4203	CR9EHIX-9	6216	5630	IFR9H11	6588
3161	BKR5EIX-11	5464	4019	BP5HS	4111	4206	CR8HSA	2086	5631	IMR9B-9H	4888
3162	BKR6EP-11	2978	4021	BP7HS	5111	4222	CR5EH-9	6689	5642	IMR9C-9HES	5766
3163	BKR6EIX-11	3764	4022	BPR7HS	6422	4223	CR8EB	7784	6000	BUHX	2522
3165	BKR7E	6097	4024	BR7HS	4122	4224	CR9EB	6955	6001	BUHW	2622
3167	ZFR4F-11	4043	4025	B7HS	5110	5018	FR5-1	7252	6002	BUHW-2	5626
3168	PFR6B-11	4014	4026	BR7HIX	7067	5020	BPR4FS	1127	6004	B-2	3110
3174	PFR5J-11	4642	4027	B7S	3710	5021	BPR4FS-15	2727	6009	B4ES	4129
3178	DCPR6E	3481	4028	BP8ES	2912	5022	BPR5EFS	2223	6011	BPR4ES	7222
3179	DCPR7E	3932	4030	B8ES	2411	5024	BP5FS	3412	6013	B-4L	3112
3184	BCPR5EY-11	4120	4032	B8EGV	5627	5025	BPR5FS	2423	6015	BM4A	5628

À TITRE INDICATIF

DENSO	NGK	N° STOCK
6018	BPMR4A	6028
6019	BMR4A	5728
6021	BP-4	2911
6023	BPM6A	7021
6025	BMR6A	7421
6028	B9HS-10	3626
6033	B-4	3210
6034	BM4A	5628
6035	B4-LM	3410
6036	BM6A	5921
6039	BM6F	6221
6040	BPM6F	5950
6041	BM7F	6421
6042	BPM7F	1268
6043	BPMR7A	4626
6044	BPR2ES	2264
6047	B8HS-10	5126
6048	BM7A	6521
6049	BPM7A	7321
6050	CR5HSB	6535
6051	B7HS	5110
6052	B7HS-10	2129
6053	BR6HS	3922
6054	B6HS	4510
6057	B2-LM	1147
6060	B8HS	5510
6068	BR8ES	5422
6069	BR9ES	5722
6070	CR4HSB	4695
6071	BR2-LM	5798
6073	B8HS-10	5126
6079	CM-6	5812
D14	BKR6E-11	2756
D21	BKR5E-11	6953
IK16	BKR5EIX-11	5464
IK16G	BKR5EIX-11	5464
IK20	BKR6EIX-11	3764
IK20G	BKR6EIX-11	3764
IK22	BKR7EIX	2667
IK22G	BKR7EIX	2667
IK24	BKR8EIX	2668
IK27	BKR9EIX	2669
IK27C11	FR9BI-11	4709
IT16	TR5IX	7397
IT20	TR6IX	3689
IT22	TR7IX	3690
IT24	TR8IX	3691
ITF16	UR5IX	7177
ITF20	UR6IX	7348
ITL16	LZTR5AIX-13	2314
IU22	CR7EIX	7385
IU24	CR8EIX	4218
IU27D	CR9EIA-9	6289
IUF22	CR7HIX	7544
IUF24	CR8HIX	7669
IUH24	CR8EHIX-9	3797
IUH27	CR9EHIX-9	6216
IUH27D	IMR9A-9H	6966
IW16	BPR5EIX-11	2115
IW20	BPR6EIX-11	3903
IW22	BPR7EIX	4055
IW24	BR8EIX	5044
IW27	BR9EIX	3981
IW29	BR10EIX	6801
IW31	BR10EIX	6801
IWF20	BPR6HIX	4085
IWF22	BR7HIX	7067
IWF24	BR8HIX	7001
IWF27	BR9HIX	5687
IWM24	BR8ECMIX	3520
IWM27	BR9ECMIX	2707
IWM31	BR10ECMIX	3006

IX22B	DPR7EIX-9	7803
IX24	DR8EIX	6681
IX24B	DPR8EIX-9	2202
IX27	DR9EIX	4772
IX27B	DPR9EIX-9	5545
IXU22	DCPR7EIX	6046
IXU24	DCPR8EIX	6546
IXU27	DCPR9EIX	2316
IY24	ER8EHIX	8201
IY27	ER9EHIX	96652
J16ARU11	BRE527Y-11	6029
J16AU11	BRE527Y-11	6029
J16BRU	BRE529Y	6229
J16BU11	BE529Y-11	5929
J16CU	BPR5EY	2828
J20AY	BPR6EY-11	4228
K14PRU11	BKR4E-11	5424
K14PU11	BKR5E-11	6953
K16PRL11	BKR5E-N-11	2391
K16PRTP11	BKR5EIX-11	5464
K16PRU	BKR5E	7938
K16PRU11	BKR5E-11	6953
K16PRUR	BKR5E	7938
K16PRZU11	BKR5EIX-11	5464
K16PU	BK5E	6233
K16PU11	BK5E-11	6234
K16RU	BKR5EYA	2087
K16RU11	BKR5EYA-11	2526
K16RZU11	BKR5EIX-11	5464
K16TNSR9	BKR5EKC	5216
K16TR11	BKR5EKB-11	3967
K16U	BKR5EYA	2087
K16U11	BKR5EYA-11	2526
K20PRL11	BKR6E-N-11	5724
K20PRTP11	BKR6EIX-11	3764
K20PRU	BKR6E	6962
K20PRU11	BKR6E-11	2756
K20PRUR	BKR6E	6962
K20PRZU11	BKR6EIX-11	3764
K20PU	BK6E	3536
K20RU	BKR6EYA	2249
K20RZ	BKR6EIX	6418
K20TNR	BKR6EKC	2848
K20TR11	BKR6EKB-11	3583
K20U	BKR6EYA	2249
K20U11	BKR6EYA-11	4073
K22P11	BK7EK-N-11	2090
K22PB	BCP7ET	2078
K22PRL11	BKR7E-N-11	6256
K22PRTP11	BKR7EIX-11	6988
K22PRU	BKR7E	6097
K22PRU11	BKR7E-11	1283
K22PRUR	BKR7E	6097
K22PRZU	BKR7EIX	2667
K22PRZU11	BKR7EIX-11	6988
K22TMR	BKR7EKC-N	2095
K22TNR	BKR7EKC	7354
K24PRU11	BKR8E-11	6587
K24PRZU	BKR8EIX	2668
KJ14CR11	ZFR4F-11	4043
KJ14CRL11	ZFR4F-11	4043
L14U	AB-6	2910
L14V	AB-2	3020
M17	AB-6	2910
M22	AB-7	3010
M24S	AB-8	7909
MW17	AB-6	2910
MW22	AB-7	3010
MW9	AB-2	3020
P16R	BPR5EP-11	3971
P20R8	BPR6EP-8	4542
PK16PR11	PFR5B-11	2300
PK16PRL11	PFR5G-11	2647
PK16PRP11	PFR5J-11	4642

PK16R11	BKR5EP-11	3440
PK16R8	BKR6EP-8	2215
PK16TR13	BKR5EKP-13	6874
PK20PR11	PFR6B-11	4014
PK20PRL11	PFR6G-11	5555
PK20PRP	PFR6J	2645
PK20PRP11	PFR6J-11	2743
PK20PTRS9	BKR6EKPA	2513
PK20R11	BKR6EP-11	2978
PK20R13	BKR6EP-13	2550
PK20R8	BKR6EP-8	2215
PK20TR11	BKR6EKP-11	3452
PK22PR11	PFR7B-11	5667
PK22PR8	PFR7B	4853
PK22PRL11S	PFR7G-11S	7772
PQ16R	BCPR5EIX-11	3306
PQ16R8	BCPR5EP-8	2950
PQ20R	BCPR6EP-11	3350
PQ20R13	BCPR6EIX-11	4919
PQ20R8	BCPR6EP-8	3933
PQ20RP8	BCPR6EP-N-8	5275
PTJ16CR15	PZTR5A-15	7862
PTJ16R15	PZTR5A-15	7862
Q16PRTP11	BCPR5EIX-11	3306
Q16PRU	BCPR5E	1145
Q16PRU11	BCPR5EY-11	4120
Q16PRZU11	BCPR5EIX-11	3306
Q16PU11	BCPR5EY-11	4120
Q16RU	BCPR5EY	1266
Q16RU11	BCPR5EY-11	4120
Q16RZU11	BCPR5EIX-11	3306
Q16U11	BCPR5EY-11	4120
Q16ZU11	BCPR5EIX-11	3306
Q20PRP11	BCPR6EIX-11	4919
Q20PRU	BKR6E	6962
Q20PRU11	BCPR6EY-11	3720
Q20PRUL11	BCPR6EY-N-11	6262
Q20PRZU11	BCPR6EIX-11	4919
Q20PU	BCP6ES	4930
Q20RU	BCPR6EY	1146
Q20RZU11	BCPR6EIX-11	4919
Q20U	BCP6E	5860
Q20U11	BKR6E-11	2756
Q20ZU11	BCPR6EIX-11	4919
Q22PRP11	BKR7EIX-11	6988
Q22PRU	BCPR7E	1272
Q22PRU11	BCPR7E-11	1267
Q22PRUL11	BCPR7EY-N-11	2059
Q22PRZU	BCPR7EIX	5690
Q22PRZU11	BCPR7EIX	5690
QJ16ARU	BCRE527Y	2074
QJ16HRU	FR5-1	7252
QJ16HRU9	FR5-1	7252
SF10	BUHX	2522
SF24	BU8H	6431
SF50	BUHW	2622
SF51	BUHW-2	5626
SVK20RZ8	BKR6EP-8	2215
T14PRU	BPR4FS	1127
T14PRU15	BPR4FS-15	2727
T16EPRU	BPR5EFS	2223
T16EXU	BP5EFS	3712
T16PRU	BPR5FS	2423
T16PRU11	BPR5FS-11	2924
T16PRU15	BPR5FS-15	3124
T16PU	BP5FS	3412
T16RU	BR5FS	4123
T16RU15	BR5FS	4123
T16U15	YR55IX	7588
T20EP15	BPR6EFS-15	4871
T20EPRU	BPR6EFS	3623
T20EPRU15	BPR6EFS-15	4871
T20EPU	BP6EFS	3812
T20EPU15	BPR6EFS-15	4871

T20EXU	BP6EFS	3812
T20MPU	BPM6F	5950
T20MU	BM6F	6221
T20PRU	BPR6FS	2623
T20PRU11	BPR6FS	2623
T20PRU15	BPR6FS	2623
T20PU	BP6FS	3512
T20RU	BR6FS	4323
T20RU15	BR6FS	4323
T22EPU	BP7EFS	3526
T22MPU	BPM7F	1268
T22MU	BM7F	6421
TR20	B6HS	4510
TR22	B7HS	5110
TR24	B8HS	5510
TR2210	B7HS-10	2129
TR2410	B8HS-10	5126
U14FSRUB	CR4HSB	4695
U14FSUB	C4HSB	2409
U16FER9	CR5EH-9	6689
U16FSL	C5HSA	4429
U16FSL	CR5HSA	7840
U16FSRU	CR5HSA	7840
U16FSRUB	CR5HSB	6535
U16FSU	C5HSA	4429
U16FSUB	C5HSB	6452
U17F	C5HSA	4429
U20EPR9	CPR6EA-9	6899
U20EPRU	CPR6EA-9	6899
U20ESRN	CR6E	6965
U20FS	C6HSA	3228
U20FSL	C6HSA	3228
U20FSRU	CR6HSA	2983
U20FSU	C6HSA	3228
U20MU	CM-6	5812
U21FB	C6HSA	3228
U22EPRU	CPR7EA-9	3901
U22ESRN	CR7E	4578
U22ETR	CR7EK	7546
U22FER9	CR7EH-9	3486
U22FS	C7HSA	4629
U22FSGU	CR7HIX	7544
U22FSL	C7HSA	4629
U22FSU	C7HSA	4629
U22FSZU	CR7HIX	7544
U24ESRN	CR8E	1275
U24ESRNB	CR8EB	7784
U24ESRNZU	CR8EIX	4218
U24ETR	CR8EK	3478
U24FB	CR8HSA	6821
U24FE9	C8EH-9	7473
U24FER9	CR8EH-9	5666
U24FER9S	CR8EH-9S	7750
U24FERZU9	CR8EHIX-9	3797
U24FS	C8HSA	6821
U24FSL	C8HSA	6821
U24FSRZU	CR8HIX	7669
U24FSU	C8HSA	6821
U24FSZU	CR8HIX	7669
U27ESNZU	CR9EIX	3521
U27ESRN	CR9E	6263
U27ESRNB	CR9EB	6955
U27ESRNZU	CR9EIX	3521
U27ETR	CR9EK	4548
U27FE9	C9EH-9	2142
U27FER9	CR9EH-9	7502
U27FERZU9	CR9EHIX-9	6216
U27FEZU9	CR9EHIX-9	6216
U31ESRN	CR10E	6264
U31ESRNZU	CR10EIX	6482
U31ETR	CR10EK	2360
VK16PRZ11	IFR5L11	6502
VK20PRZ11	IFR6L11	3678
VK24PRZ11	IFR8H11	5068

À TITRE INDICATIF

VK27PRZ11	IFR9H11	6588	W16EP	BP5ES	6511	W20ESU11	B6ES-11	7910	W22ESU11	B7ES-11	2311
VNH27Z	IMR9B-9H	4888	W16EP11	BP5ES-11	7311	W20ET	BPR6EK-A	7726	W22ESZU	BR7EIX	6664
VQ20	BCPR6EIX-11P	4174	W16EPB	BP5EY	7327	W20ETL	BPR6EKN	1128	W22ETL	BPR7EKN	7738
VUH24D	IMR8C-9H	3653	W16EPGU	BPR5EIX	6597	W20ETR	BPR6EK-A	7726	W22ETRL	BPR7EKN	7738
VUH27D	IMR9C-9H	6777	W16EPR	BPR5ES	7422	W20ETRL	BPR6EKN	1128	W22ETRL8	BPR7EKN	7738
VUH27ES	IMR9C-9HES	5766	W16EPR11	BPR5ES-11	4424	W20ETRL8	BPR6EKN	1128	W22EXRU	BPR7EIX	4055
VUH27Z	IMR9A-9H	6966	W16EPRS11	BUR5EA-11	1180	W20ETRS	BPR6EK-A	7726	W22EXRU11	BPR7EY-11	1149
VW22	BPR7EIX	4055	W16EPRU	BPR5ES	7422	W20ETS	BPR6EK-A	7726	W22EXU	BP7EY	1087
VX22BC	IJR7A9	7901	W16EPRU10	BPR5E-11	5638	W20EXRU	BPR6EY	6427	W22FP	BP7HS	5111
VX22BZ	IJR7A9	7901	W16EPRU11	BPR5ES-11	4424	W20EXRU11	BPR6EY-11	4228	W22FPR	BPR7HS	6422
W9	B-2	3110	W16EPU	BP5ES	6511	W20EXRU13	BPR6EIX-11	3903	W22FPRU	BPR7HS	6422
W9EP	BP-2E	5411	W16EPU10	BP5ES-11	7311	W20EXRZU	BPR6EIX	6637	W22FPRZU	BPR7HIX	5944
W9EPR	BPR2ES	2264	W16EPZU	BPR5EIX	6597	W20EXU	BP6EY	7727	W22FPU	BP7HS	5111
W9EXRU	BPR2ES	2264	W16ES	B5ES	6410	W20EXU11	BP6EY-11	4128	W22FPU10	BP7HS-10	7829
W9EXU	BP-2E	5411	W16ESL	BR5ES	4722	W20EXU13	BP6ES-13	2212	W22FPUS	BP7HS	5111
W9FPL	BP2HS	7926	W16ESRL	BR5ES	4722	W20EXZU	BPR6EIX	6637	W22FRL	BR8HSA	5539
W9FPUL	BP2HS	7926	W16ESRL11	BUR5EB-11	3232	W20FP	BP6HS	4511	W22FS	B7HS	5110
W9FPUL	BP2HS	7926	W16ESRU	BR5ES	4722	W20FPL	BP6HSA	1046	W22FSGU	BR7HIX	7067
W9LMRUS	BR2-LM	5798	W16ESU	B5ES	6410	W20FPR	BPR6HS	7022	W22FSR	BR7HS	4122
W9LMUS	B2-LM	1147	W16ETL	BPR5EY	2828	W20FPRL	BPR6HSA	4632	W22FSRU	BR7HS	4122
W9P	BP-4	2911	W16ETRS	BPR5EIX-11	2115	W20FPRU	BPR6HS	7022	W22FSU	B7HS	5110
W9PRU	BP-4	2911	W16EX	BP5EY	7327	W20FPRU10	BPR6HS-10	2633	W22FSU10	B7HS-10	2129
W9PU	BP-4	2911	W16EXRU	BPR5EY	2828	W20FPRL10	BPR6HS-10	2633	W22FSZU	BR7HIX	7067
W9U	B-2	3110	W16EXRU11	BPR5EY-11	3028	W20FPU	BP6HS	4511	W22M	BM7A	6521
W14	B-4	3210	W16EXRU13	BPR5ES-13	3154	W20FPU10	BP6HS-10	6326	W22MPRU	BPM7A	4626
W14E	B4ES	4129	W16EXRZU	BPR5EIX	6597	W20FRL	BPR6HSA	4296	W22MPU	BPM7A	7321
W14EKRS11	BUR4EB-11	4534	W16EXU	BP5EY	7327	W20FS	B6HS	4510	W22MPUS	BPM7A	7321
W14EP	BP4ES	6928	W16EXU11	BP5EY-11	4028	W20FSGU	BR6HIX	3419	W22MU	BM7A	6521
W14EPR	BPR4ES	7222	W16EXU13	BP5ES-13	4012	W20FSR	BR6HS	3922	W22MUS	BM7A	6521
W14EPR11	BPR4ES-11	4224	W16EXZU	BPR5EIX	6597	W20FSRU	BR6HS	3922	W22S	B7S	3710
W14EPRU	BPR4ES	7222	W16FP	BP5HS	4111	W20FSU	B6HS	4510	W22SU	B7S	3710
W14EPU	BP4ES	6928	W16FPL	BP5HA	7426	W20FSU10	B6HS-10	1052	W24	B8S	3810
W14ERU	BR4ES	1097	W16FPR	BPR5HS	6222	W20FSZU	BR6HIX	3419	W24EMRC	BR8ECM	3035
W14EXRU	BPR4EY	2128	W16FPRU	BPR5HS	6222	W20M	BM6A	5921	W24EP	BP8ES	2912
W14EXRU11	BPR4EY-11	1143	W16FPU	BP5HS	4111	W20MPRU10	BPMR6A-10	1029	W24EP11	BP8ES	2912
W14EXRU13	BPR4ES-13	2642	W16FPU10	BP5HS-10	7429	W20MPU	BPM6A	7021	W24EPR	BPR8ES	3923
W14EXRZU	GR4IX	7149	W16FPUL	BP5HA	7426	W20MPU10	BPM6A-10	6026	W24EPRU	BPR8ES	3923
W14EXU	BP4EY	1028	W16FS	B5HS	4210	W20MRU	BMR6A	7421	W24EPRZU	BPR8EIX	6684
W14EXU11	BP4EY-11	3928	W16FSR	BR5HS	3722	W20MU	BM6A	5921	W24EPU	BP8ES	2912
W14EXU13	BPR4ES-13	2642	W16FSU	B5HS	4210	W20MUS	BM6A	5921	W24ES	B8ES	2411
W14EXZU	GR4IX	7149	W16LS	B-6L	3212	W20PRU	BP6S	3111	W24ESGU	BR8EIX	5044
W14F	B-4H	4110	W16PRU	BP5S	3011	W20PU	BP6S	3111	W24ESR	BR8ES	5422
W14FP	BP-4H	3311	W16PU	BP5S	3011	W20S	B6S	3510	W24ESRU	BR8ES	5422
W14FPL	BP4HS	3611	W17	B6S	3510	W20SRU	BR6S	3522	W24ESRV	BR8EG	3130
W14FPLUL	BP4HA	3511	W17FP	BP6HS	4511	W20SU	B6S	3510	W24ESRZU	BR8EIX	5044
W14FPRL	BPR4HS	7823	W17P	BP6S	3111	W21ESL11	BR6EB-L-11	7028	W24ESU	B8ES	2411
W14FPRU	BPR-4H	7623	W17PRU	BP6S	3111	W21ESRL11	BR6EB-L-11	7028	W24ESV	B8EG	3430
W14FPRUL	BPR4HS	7823	W17PU	BP6S	3111	W22	B7S	3710	W24ESZU	B8EGV	5627
W14FPRUL10	BPR4HS-10	5024	W20EKRS11	BUR6EB-11	5730	W22EB	BR7ET	4121	W24FP	BP8HS	2630
W14FPU	BP-4H	3311	W20EKS11	BUR6EB-11	5730	W22EBR	BR7ET	4121	W24FPL	BPR8HSA	7937
W14FPUL	BP4HS	3611	W20EP	B6ES	7310	W22EKS11	BUR7EB-11	6832	W24FPR	BPR8HS	3725
W14FPUL10	BP4HS-10	5011	W20EP11	BP6ES-11	1212	W22EKS11	BUR7EB-11	6832	W24FPRL	BPR8HSA	7937
W14FRL	BR4HSA	2751	W20EPGU	BPR6EIX	6637	W22EP	BP7ES	2412	W24FPRU10	BPR8HS-10	4839
W14FRU	BR4HS	3322	W20EPR	BPR6ES	7822	W22EP11	BP7ES-11	2712	W24FPU	BP8HS	2630
W14FU	B-4H	4110	W20EPR11	BPR6ES-11	4824	W22EPB	BP7ET	3684	W24FRL	BR8HSA	5539
W14FU10	B-4H-10	4010	W20EPRS11	BUR6EA-11	5428	W22EPGU	BPR7EIX	4055	W24FS	B8HS	5510
W14L	B-4L	3112	W20EPRU	BPR6ES	7822	W22EPGU	BPR7EIX	4055	W24FSGU	BR8HIX	7001
W14LMRUS	BR4-LM	4133	W20EPRU10	BPR6ES-11	4824	W22EPR	BPR7ES	2023	W24FSR	BR8HS	4322
W14LMU	B4-LM	3410	W20EPRU11	BPR6ES-11	4824	W22EPR11	BPR7ES-11	7226	W24FSRU10	BR8HS-10	1134
W14LMUS	B4-LM	3410	W20EPRZU	BPR6EIX	6637	W22EPRS11	BUR7EA-11	7031	W24FSU	B8HS	5510
W14MPRU10	BPMR4A-10	6328	W20EPRZU11	BPR6EIX-11	3903	W22EPRU	BPR7ES	2023	W24FSU10	B8HS-10	5126
W14MPU10	BPM4A-10	6228	W20EPS11	BUR6EA-11	5428	W22EPRU11	BPR7ES-11	7226	W24FSZU	BR8HIX	7001
W14MRU	BMR4A	5728	W20EPU	BP6ES	7811	W22EPRZU	BPR7EIX	4055	W24S	B8S	3810
W14MU	BM4A	5628	W20EPU10	BP6ES-11	1212	W22EPS11	BUR7EA-11	7031	W24SU	B8S	3810
W14MUS	BM4A	5628	W20EPU11	BP6ES-11	1212	W22EPU	BP7ES	2412	W25EB	BR8ET	4221
W14P	BP5S	3011	W20EPU11	BP6ES-11	1212	W22EPU11	BP7ES-11	2712	W25EBR	BR8ET	4221
W14PRU	BP-4	2911	W20EPZU	BPR6EIX	6637	W22EPZU	BPR7EIX	4055	W25EN	B8EG	3430
W14PU	BP-4	2911	W20ES	B6ES	7310	W22ES	B7ES	1111	W25EPT	B8EGP	2046
W14U	B-4	3210	W20ESL	BR6ES	4922	W22ESGU	BR7EIX	6664	W25FC	B8HCS	2621
W14U10	B-4	3210	W20ESL11	BUR6EB-11	5730	W22ESL11	BUR7EB-11	6832	W25FN	BR8HIX	7001
W14US	B-4	3210	W20ESR	BR6ES	4922	W22ESR	BR7ES	5122	W27EBR	BR9ET	4528
W16DTRS	BPR5EKB	5449	W20ESRL	BR6ES	4922	W22ESRL	BR7ES	5122	W27EMRC	BR9ECM	3252
W16EKRS11	BUR5EB-11	3232	W20ESRL11	BUR6EB-11	5730	W22ESRL11	BUR7EB-11	6832	W27EMRZU	BR9ECMIX	2707
W16EKS11	BUR5EB-11	3232	W20ESRU	BR6ES	4922	W22ESRU	BR7ES	5122	W27EN	B9EG	3530
			W20ESU	B6ES	7310	W22ESU	B7ES	1111			

À TITRE INDICATIF

DENSO	NGK	N° STOCK
W27EPT	BR9EIX	3981
W27ES	B9ES	2611
W27ESC	B9ECS	7058
W27ESGU	BR9EIX	3981
W27ESR	BR9ES	5722
W27ESRU	BR9ES	5722
W27ESRV	BR9EG	3230
W27ESU	B9ES	2611
W27ESV	B9EG	3530
W27ESZU	B9EGV	5827
W27FC	B9HCS	2721
W27FN	BR9HIX	5687
W27FS	B9HS	5810
W27FSGU	BR9HIX	5687
W27FSR	BR9HS	4522
W27FSRU10	BR9HS-10	4551
W27FSU	B9HS	5810
W27FSU10	B9HS-10	3626
W27FSZU	BR9HIX	5687
W29EBR	BR10ET	7480
W29EPT	B95EGP	7450
W29ESGU	B95EGV	2145
W29ESRV	BR10EG	3830
W29ESV	B10EG	3630
W29ESZU	B95EGV	2145
W31EMRC	BR10ECM	4234
W31EMRZU	BR10ECMIX	3006
W31EN	B10EG	3630
W31EPT	B10EGP	5224
W31ES	B10ES	7928
W31ESGU	BR10EIX	6801
W31ESRU	BR10ES	4832
W31ESRZU	BR10EIX	6801
W31ESU	B10ES	7928
W31ESZU	B10EGV	5927
W31FS	B10HS	2399
W31FSGU	BR10HIX	6692
W31FSZU	BR10HIX	6692
W32EPT	B105EGP	2077
W34EN	B11EG	2055
W34ESZU	B11EGV	5831
WA20M	BM6F	6221
WA20MU	BM6F	6221
WA22M	BM7F	6421
WA22MU	BM7F	6421
X16EPRU9	DPR5EA-9	2887
X16EPU9	DPR5EA-9	2887
X16FSRU	DR5HS	4623
X16FSU	D5HS	6212
X20EPRU9	DPR6EA-9	5531
X20EPU9	DP6EA-9	1068
X20ESU	D6EA	7512
X20FSRU	DR6HS	4823
X20FSU	D6HA	6512
X22EPRGL	PJR7A	2842
X22EPRU9	DPR7EA-9	5129
X22EPRZU9	DPR7EIX-9	7803
X22EPU	DP7EA-9	5629
X22EPU9	DP7EA-9	5629
X22EPZU9	DPR7EIX-9	7803
X22ESGU	DR7EIX	5686
X22ESU	D7EA	7912
X22GPRU	DPR7Z	5537
X22GPU	DPR7Z	5537
X24EPRZU9	DPR8EIX-9	2202
X24EPU	DP8EA-9	5829
X24EPU9	DP8EA-9	5829
X24EPZU9	DPR8EIX-9	2202
X24ESGU	DR8EIX	6681
X24ESRZU	DR8EIX	6681
X24ESRZU9	DR8EIX	6681
X24ESU	D8EA	2120

X24ESZU	DR8EIX	6681
X24ESZU9	DR8EIX	6681
X24FSRU	DR8HS	5123
X24FSU	D8HA	7112
X24GPRU	DPR8Z	4730
X24GPU	DP8Z	4430
X27EPRU9	DPR9EA-9	5329
X27EPZU9	DPR9EIX-9	5545
X27EPU9	DP9EA-9	6629
X27EPZU9	DPR9EIX-9	5545
X27ESRZU	DR9EIX	4772
X27ESRZU9	DR9EIX	4772
X27ESU	D9EA	2420
X27ESZU	DR9EIX	4772
X27ESZU9	DR9EIX	4772
X27ET	J9A	2170
X27GPU	DPR9Z	4830
X29ESZU	DR9EIX	4772
X31ESU	D10EA	2720
X31ETR	JR10B	1299
XU20EPRU	DCPR6E	3481
XU20EPU	DCP6E	2256
XU22EPP	DCPR7EIX	6046
XU22EPR	DCPR7E	3932
XU22EPRP	DCPR7EIX	6046
XU22EPRU	DCPR7E	3932
XU22EPRZU	DCPR7EIX	6046
XU22EPU	DCP7E	2363
XU22EPZU	DCPR7EIX	6046
XU22PR9	DCPR7EA-9	6651
XU24EPRP	DCPR8EIX	6546
XU24EPRU	DCPR8E	4339
XU24EPRZU	DCPR8EIX	6546
XU24EPU	DCPR8E	4339
XU24EPZU	DCPR8EIX	6546
XU27EPRU	DCPR9E	2641
XU27EPRZU	DCPR9EIX	2316
Y24FERC	ER8EH	4011
Y27FER	ER9EH	5869
Y27FERC	ER9EH	5869
Y31FERC	ER10EH	2862
Z20ESU	D6EA	7512

EVINRUDE	NGK	N° STOCK
204470091	BR7ES	5122
278000237	BR7ES	5122
278000608	BR7ES	5122
278000609	BR8ES	5422
MCBR8EG	BR8EG	3130
MCBR8HS	BR8HS	4322
MCBR9EG	BR9EG	3230
MCBR9ES	BR9ES	5722
MCBR10EG	BR10EG	3830

FUJI	NGK	N° STOCK
211-72802-00	Y-401-3	2226

HARLEY-DAVIDSON	NGK	N° STOCK
6R12	DCPR8E	4339

HKT	NGK	N° STOCK
PD-99	Y-108	6725
PD-191	Y-703R	3782
PH-21	Y-176	7625
PI-40	Y-874-1	5326
PI-42	Y-104	6425
PI-44	Y-271-2	7467
PM-60	Y-172	7325
PM-61	Y-175-2	6230
PM-62	Y-102	5925
PM-66	Y-180	5926
PM-71	Y-172	7325
PM-73	Y-274	2165

PM-79	Y-114T	6528
PN-122	Y-202-2	3226
PN-124	Y-162R1	2431
PN-128	Y-112R1	1032
PN-131	Y-755RS	7771
PN-132	Y-705RS	1249
PN-135	Y-707RS	4937
PN-136	Y-757RS	4018
PN-81	Y-103	6125
PN-82	Y-252	2126
PN-84	Y-202	1226
PN-85	Y-103-1	6225
PN-86	Y-103-2	2926
PN-87	Y-112T	6327
PN-88	Y-177-1	3026
PN-89	Y-204TS1	3829
PS-201	Y-103V	2031
PS-202	Y-106V	6926
PS-203	Y-107V	6628
PS-204	Y-106-1	6525
PS-206	YE01	2649
PS-207	Y-709R	3238
PS-208	Y-716RS	4693
PS-209	Y-119V	7465
PS-210	Y-702U	2966
PS-217	Y-182T1	5619
PT-150	Y-703R	3782
PT-90	Y-402-2	4926
PZ34	Y-122	6925

HONDA	NGK	N° STOCK
12290-P73-J001	PFR7G-11	2380
12290-PCX-0000	PFR7G-11S	7772
12290-PCX-9999-TA	PFR7G-11S	7772
12290-PCX-J000	PFR7G-11S	7772
12290-PNE-0030	ZFR6K-11	6711
30717002 / 0	DR9EA	3437
31901-NN2-0030	BR6ES	4922
31908-KTW-901	LMAR8A-9	4313
31908-KTW-9010-M1	LMAR8A-9	4313
31908-KTW-9011-M1	LMAR8A-9	4313
31908-MGC-003	LMAR8A-9S	6817
31908-MGC-0031	LMAR8A-9S	6817
31908-MGC-A0000	LMAR8A-9S	6817
31909-MEN-A31	SILMAR9A9S	6213
31909-MEN-A310-M1	SILMAR9A9S	6213
31909-MGC-0031	LMAR8A-9S	6817
31910-MEN-A31	SILMAR10A9S	7764
31911-HW1-671	IMR9D-9H	6544
31911-HW1-6710-M1	IMR9D-9H	6544
31911-KSK-731	BR9EG-N8	2689
31911-KSK-7310-M1	BR9EG-N8	2689
31911-MBT-F210-M1	IJR8B9	4873
31911-MBW-E11	IMR8C-9H	3653
31911-MBW-E111-M1	IMR8C-9H	3653
31911-MBW-E112-M1	IMR8C-9H	3653
31911-MEE-J01	IMR8C-9HES	5990
31911-MEE-J010-M1	IMR8C-9HES	5990
31911-MEE-J011-M1	IMR8C-9HES	5990
31912-MBW-E11	IMR9C-9H	6777
31912-MBW-E111-M1	IMR9C-9H	6777
31912-MBW-E112-M1	IMR9C-9H	6777
31912-MCW-003	IMR9B-9H	4888
31912-MCW-0030	IMR9B-9H	4888
31912-MEE-0000	IMR9C-9H	6777
31912-MEE-J01	IMR8C-9HES	5990
31912-MEL-003	IMR9C-9HES	5766
31912-MEL-0030	IMR9C-9HES	5766
31912-MEL-A	IMR9C-9HES	5766
31912-MFL-003	IMR9E-9HES	7556
31912-MFL-0030	IMR9E-9HES	7556
31912-MGH-641	IMR8E-9HES	95397
31915-ZOH-003	CMR5H	7599
31915-ZOH-0030	CMR5H	7599

31915-ZOH-0031	CMR5H	7599
31916-KPH-901	CPR6EA-9	6899
31916-KPH-9010-M1	CPR6EA-9	6899
31916-KRM-8410-M1	CPR8EA-9	2306
31916-KRM-8413-M1	CPR8EA-9	2306
31916-KWB-601	CPR6EA-9S	1582
31916-MEH-003	SIMR8A9	91064
31916-MEH-0030	SIMR8A9	91064
31916-ZOH-003	CMR6H	3365
31916-ZX2-003	ZFR6K-11E	94001
31916-ZY3-003	IZFR6F11	4095
31916-ZY3-0030	IZFR6F11	4095
31916-ZY3-0032	IZFR6F11	4095
31916-ZY3-004	IZFR6F11	4095
31917-KPH-901	CPR7EA-9	3901
31918-K44-V01	MR8C-9N	97985
31918-MEB-671	IFR8H11	5068
31918-MEB-6710-M1	IFR8H11	5068
31918-MEB-672	IFR9H11	6588
31919-MEB-671	IFR9H11	6588
31919-MEB-6710-M1	IFR9H11	6588
31919-MEB-672	IFR8H11	5068
31919-ZX2-0030	ZFR6K-11E	94001
3191W-ZOM-5400	BPR4ES	7222
3191W-ZOM-5500	BPR5ES	7422
3191W-ZOM-5600	BPR6ES	7822
31921-MBW-E12	IMR8C-9H	3653
31922-MBW-E12	IMR9C-9H	6777
31922-MEL-003	IMR9C-9HES	5766
31922-MFL-003	IMR9E-9HES	7556
31922-MOW-004	IMR9B-9H	4888
31926-KRM-841	CPR9EA-9	2308
31988-GEV-761	ER8EH-N	5606
31988-GEV-7611-M1	ER8EH-N	5606
31999-KW6-6500	B9ECS	7058
89819-99010	BPR5ES	7422
89839-99010	BPR6ES	7822
94701-00408	CR9EIA-9	6289
98049-58716	ER8EH	4011
98049-59716	ER9EH	5869
98049-59726	ER9EH	5869
98049-60716	ER10EH	2862
98052-56471	CM-6	5812
98056-54718	CR4HSA	2430
98056-54750	C4HSB	2409
98056-54757	CR4HSB	4695
98056-54777	CR4HSB	4695
98056-55713	C5HSA	4429
98056-55718	CR5HSA	7840
98056-55726	CR5HSA	7840
98056-55750	C5HSB	6452
98056-55757	CR5HSB	6535
98056-55770	C5HSB	6452
98056-55777	CR5HSB	6535
98056-56713	C6HSA	3228
98056-56713-00	C6HSA	3228
98056-56713-01	C6HSA	3228
98056-56716	CR6HS	7023
98056-56717-00	CR6HSA	2983
98056-56718	CR6HSA	2983
98056-5671R-00	CR6HSA	2983
98056-56723	C6HSA	3228
98056-56726	CR6HSA	2983
98056-57113	C7HSA	4629
98056-57113-00	C7HSA	4629
98056-57113-0A	C7HSA	4629
98056-57118	CR7HSA	4549
98056-5711R-00	CR7HSA	4549
98056-5726	CR7HSA	4549
98056-57918	CR7HSA-9	5147
98056-58713	C8HSA	6821
98056-58716	CR8HS	7423
98056-58718	CR8HSA	2086
98059-55916	CR5EH-9	6689

À TITRE INDICATIF

98059-56916	CR6EH-9	2688
98059-57817-00	CR7E	4578
98059-57916	CR7EH-9	3486
98059-57916-00	CR7E	4578
98059-57926	CR7EH-9	3486
98059-58816	CR8E	1275
98059-58816-H0	CR8E	1275
98059-58817-00	CR8E	1275
98059-58910	C8EH-9	7473
98059-58916	CR8EH-9	5666
98059-58916-00	CR8E	1275
98059-5891F	CR8EHIX-9	3797
98059-58920	C8EH-9	7473
98059-58926	CR8EH-9	5666
98059-5892D	IMR8C-9H	3653
98059-589J6	CR8EH-9S	7750
98059-589K6	CR8EH-9S	7750
98059-59816	CR9E	6263
98059-59816-H0	CR9E	6263
98059-59910	C9EH-9	2142
98059-59916	CR9EH-9	7502
98059-5991F	CR9EHIX-9	6216
98059-5991U	IMR9A-9H	6966
98059-5992U	IMR9C-9H	6777
98059-599U	CR9EH-9	6419
98059-60916	CR10EH-9	6548
98066-56710	D5HS	6212
98066-56716	DR5HS	4623
98066-56740	D5HS	6212
98066-56710	D6HA	6512
98066-56716	DR6HS	4823
98066-56717	D6HA	6512
98066-56726	DR6HS	4823
98066-58710	D8HA	7112
98066-58714	D8HA	7112
98066-58716	DR8HS	5123
98066-58717	D8HA	7112
98069-38716	DR8ES-L	2923
98069-38719	DR8ES-L	2923
98069-56717	D6EA	7512
98069-5697Q	DCPR6E	3481
98069-5697Q-HE	DCPR6EIX	8196
98069-57711	D7EA	7912
98069-57716	DR7ES	3123
98069-57717	D7EA	7912
98069-57717-00	D7EA	7912
98069-57717-02	D7EA	7912
98069-57719	DR7ES	3123
98069-5771P	DR7EA	7839
98069-5771P-00	DR7EA	7839
98069-5771R	DR8EA	7162
98069-57726	DR7EA	7839
98069-5777P	DR7EB	5469
98069-57916-00	DPR7EA-9	5129
98069-57922	DPR7EIX-9	7803
98069-5792U	IJR7A9	7901
98069-5797Q	DCPR7E	3932
98069-58716	DR8ES	5423
98069-58717	D8EA	2120
98069-58717-01	D8EA	2120
98069-58719	DR8ES	5423
98069-5871P	DR8EA	7162
98069-5871P-00	DR8EA	7162
98069-58726	DR8EA	7162
98069-58916-03	DPR8EA-9	4929
98069-58922	DPR8EIX-9	2202
98069-58926	DPR7EA-9	5129
98069-59717	D9EA	2420
98069-59926	DPR7EA-9	5129
98069-60717	D10EA	2720
98073-54740	BM4A	5628
98073-54744	BMR4A	5728
98073-54750	BM4A	5628
98073-54754	BMR4A	5728

98073-54771	BPM4A	5928
98073-54776	BPMR4A	6028
98073-54941	BPM4A-10	6228
98073-54944	BPMR4A-10	6328
98073-54951	BPM4A-10	6228
98073-56740	BM6A	5921
98073-56741	BPM6A	7021
98073-56744	BMR6A	7421
98073-56750	BM6A	5921
98073-56941	BPM6A-10	6026
98073-56944	BPMR6A-10	1029
98076-55711	BP5HS	4111
98076-55716	BR5HS	3722
98076-55717	BPR5HS	6222
98076-55719	BP5HS	4111
98076-55747	BPR5HS	6222
98076-56710	B6HS	4510
98076-56711	B6HS	4510
98076-56711-00	BP6HSA	1046
98076-56716	BR6HS	3922
98076-56717	BPR6HS	7022
98076-56719	BP6HS	4511
98076-56719-02	BP6HS	4511
98076-5671G-00	BR6HSA	4296
98076-56721	BP6HS	4511
98076-56725	BPR6HSA	6432
98076-56729	BPR6HS	7022
98076-5672G	BR6HSA	4296
98076-56740	B6HS	4510
98076-56741	B6HS	4510
98076-56747	BPR6HS	7022
98076-56756	BPR6HS	7022
98076-56917	BPR6HS-10	2633
98076-56927	BPR6HS-10	2633
98076-57710	B7HS	5110
98076-57711	BP7HS	5111
98076-57716	BR7HS	4122
98076-57717	BPR7HS	6422
98076-57719	BP7HS	5111
98076-57719-01	BP7HS	5111
98076-57740	B7HS	5110
98076-58710	B8HS	5510
98076-58711	BP8HS	2630
98076-58716	BR8HS	4322
98076-58717	BPR8HS	3725
98076-58719	BP8HS	2630
98076-5871G-00	BR8HSA	5539
98076-5871G-01	BR8HSA	5539
98076-5872G	BR8HSA	5539
98076-58740	B8HS	5510
98076-58747	BPR8HS	3725
98076-59710	B9HS	5810
98076-59740	B9HS	5810
98079-54173	BUR4EB-11	4534
98079-55132	BPR5EY-11	3028
98079-5514E	BKR5E-11	6953
98079-5514E-H0	BKR5E-11	6953
98079-5514F	BCPR5EIX-11	3306
98079-5514H	PFR5G-11	2647
98079-55155	BPR5E-11	5638
98079-55158	BCPR5E-11	1273
98079-5515E	BKR5E-11	6953
98079-5515H	PFR5G-11	2647
98079-5515J	BKR5E-N-11	2391
98079-5515U	IFR5L11	6502
98079-55173	BUR5EB-11	3232
98079-5517U	IFR5L11	6502
98079-55183	BUR5EB-11	3232
98079-55816	BR5ES	4722
98079-55817	BPR5ES	7422
98079-55841-03	BP5ES	6511
98079-55855	BPR5E	7075
98079-5585C	BKR5E	7938
98079-55876	BPR5ES	7422

98079-55876-H0	BPR5ES	7422
98079-55946	BPR5EY	2828
98079-56115	BPR6ES-11	4824
98079-56132	BPR6EY-11	4228
98079-56146	BPR6EY-11	4228
98079-56148	BCPR6E-11	3132
98079-5614E	BKR6E-11	2756
98079-5614H	PFR6G-11	5555
98079-5614J	BKR6E-N-11	5724
98079-5614J-01	BKR6E-N-11	5724
98079-56155	BPR6ES-11	4824
98079-56158	BCPR6EY-11	3720
98079-5615E	BKR6E-11	2756
98079-5615F	BCPR6EIX-11	4919
98079-5615H	PFR6G-11	5555
98079-5615J	BKR6E-N-11	5724
98079-5615U	IFR6L11	3678
98079-56173	BUR6EB-11	5730
98079-5617T	PFR6N-11	3546
98079-5617U	IFR6L11	3678
98079-56183	BUR6EB-11	5730
98079-56810	B6ES	7310
98079-56811	BP6ES	7811
98079-56832	BPR6EY	6427
98079-56846	BPR6ES	7822
98079-56847	BR6ES	4922
98079-56849	BR6ES	4922
98079-56854	BP6ES	7811
98079-56855	BPR6ES	7822
98079-5685C	BKR6E	6962
98079-56871-H0	BP6ES	7811
98079-56876-H0	BPR6ES	7822
98079-56941	BP6EY	7727
98079-56946	BPR6EY	6427
98079-569CE	BKR6E-9S	6803
98079-56A7H	PFR6G-13	4115
98079-56A7S	PFR6L-13	3141
98079-5714F	BCPR7EIX-11	5691
98079-5714H	PFR7G-11	2380
98079-5714J	BKR7E-N-11	6256
98079-57155-01	BPR7ES-11	7226
98079-57158	BCPR7E-11	1267
98079-5715E	BKR7E-11	1283
98079-5715F	BKR7EIX-11	6988
98079-5715H	PFR7G-11	2380
98079-5715J	BKR7E-N-11	6256
98079-57171	BPR7EY-11	1149
98079-57173	BUR7EB-11	6832
98079-57175	BR6EB-L-11	7028
98079-57183	BUR7EB-11	6832
98079-571BH	PFR7G-11S	7772
98079-571CH	PFR7G-11S	7772
98079-57811-01	BP7ES	2412
98079-57855	BPR7ES	2023
98079-5785C	BKR7E	6097
98079-5787T	PFR7N-D	6504
98079-5815E	BKR8E-11	6587
98079-5815U	FR8BI-11	6968
98079-58648	B8EG	3430
98079-58649	BR8EG	3130
98079-58678	B8EG	3430
98079-58679	BR8EG	3130
98079-58810-01	B8ES	2411
98079-58812	B9ECS	7058
98079-58841	BP8ES	2912
98079-58845	BR8ECM	3035
98079-58857	BR8ES	5422
98079-58875	BR8ECM	3035
98079-5915U	FR9BI-11	4709
98079-59648	B9EG	3530
98079-59649	BR9EG	3230
98079-59659	BR9EG	3230
98079-59678	B9EG	3530
98079-59679	BR9EG	3230

98079-59810	B9ES	2611
98079-59811	B9ES	2611
98079-59812	B9ECS	7058
98079-59840	B9ES	2611
98079-59842	B9ECS	7058
98079-59845	BR9ECM	3252
98079-59855	BR9ECM	3252
98079-59870	B9ES	2611
98079-59872	B9ECS	7058
98079-59875	BR9ECM	3252
98079-60616	BR10EIX	6801
98079-60646	BR10EIX	6801
98079-60648	B10EG	3630
98079-60649	BR10EG	3830
98079-60676	BR10EIX	6801
98079-60678	B10EG	3630
98079-60679	BR10EG	3830
98079-60817	BR10ES	4832
98079-60819	BR10ECS	5880
98079-60842	B10ECS	2199
98079-60845	BR10ECM	4234
98079-60872	B10ECS	2199
98079-60875	BR10ECM	4234
98735-4776	BPMR4A	6028

HUSQVARNA NGK N° STOCK		
8 528 522	LMAR8C-9	93833

ISEKI NGK N° STOCK		
6281-410-023-00	Y-510R	91712
6281-410-023-0A	Y-510R	91712

ISKRA NGK N° STOCK		
F20	B-4H	4110
F50	B5HS	4210
F55PS	BP5HS	4111
F65PRS	BPR6HS	7022
F65PS		

À TITRE INDICATIF

ISKRA	NGK	N° STOCK
FS75	B7S	3710
FS75C	BPM7A	7321
FT65PS	BP6FS	3512
M60	AB-6	2910
M75	AB-7	3010
M80	AB-8	7909
SFE55PRS	BKR5E	7938
SFE55PS	BCP5ES	7496
SFE65PRS	BKR6E	6962
SFE65PS	BCP6ES	4930
SFE65PTRS	BCPR6ET	2197
SFE65PTS	BCP6ET	4563
SFE85PRS	BKR7E	6097
SFE85PRS	BCPR7ES	3330
SFE85PS	BCP7ES	5030
SFE85PTRS	BCPR7ET	2164
SFE85PTS	BCP7ET	2078
T90	C7HSA	4629
TWE85PRS	DCPR8E	4339
TWE85PS	DCP7E	2363

ISUZU	NGK	N° STOCK
5-86101644-0	Y-707RS	4937
5-86115977-0	Y-757RS	4018
8-97073641-0	Y-904R1	90958
8-97073641-1	Y-904R1	90958
8-97106549-1	Y-720U1	5392
8-97106549-4	Y-720U1	5392
9-82511945-0	Y-874-1	5326
9-82511978-0	Y-104	6425
9-82511994-0	Y-874-1	5326
9-82513928-2	Y-271-2	7467
9-82513928-8	Y-271-2	7467

JOHNSON	NGK	N° STOCK
204470091	BR7ES	5122
278000237	BR7ES	5122
278000608	BR7ES	5122
278000609	BR8ES	5422
MCBR8EG	BR8EG	3130
MCBR8HS	BR8HS	4322
MCBR9EG	BR9EG	3230
MCBR9ES	BR9ES	5722
MCBR10EG	BR10EG	3830

KAWASAKI	NGK	N° STOCK
92070-0020	CPR8EB-9	6607
92070-1198	R6254E-9	5583
92070-2077	BPR6ES	7822
92070-3707	PMR9B	4717
E92070001	B7HS	5110
E92070014	B6ES	7310
E92070015	B7ES	1111
E92070036	B9HS	5810
E92070037	B8ES	2411
E92070054	B9ES	2611
E920701002	B7ES	1111
E920701019	DR8ES	5423
E920701024	BP6ES	7811
E920701025	BPR6ES	7822
E920701026	BP7ES	2412
E920701027	BPR7ES	2023
E920701034	D9EA	2420
E920701044	BPR8ES	3923
E920701065	DPR8EA-9	4929
E920701066	DP8EA-9	5829
E920701068	DPR9EA-9	5329
E920701109	BR9ES	5722
E920701113	DR7ES	3123
E920701114	C6HSA	3228
E920701116	DR8ES-L	2923
E920701125	DPR7EA-9	5129

E920701138	DPR6EA-9	5531
E920701143	CR9E	6263
E920701145	CR9EK	4548
E920701154	CR7HSA	4549
E920701155	CR8HSA	2086
E920701158	CR8EK	3478
E920701169	CR8E	1275
E920701173	BR10ES	4832
E920701189	DR9EA	3437
E920701199	DR8EA	7162
E920701209	CR7E	4578
E920701250	DPR5EA-9	2887
E920701254	CR9EKPA	7785
E920701255	CR8EKPA	6985
E920702078	BR8ES	5422

KTM	NGK	N° STOCK
778 39 093 000	LMAR9A1-10	93188

KUBOTA	NGK	N° STOCK
8412	Y-103K	6325
07909-2225-0	BM6A	5921
07909-2226-0	BM7A	6521
10202-6771-6	AB-6	2910
12268-6771-1	BP-2E	5411
12366-6771-6	BR4HS	3322
12392-6771-1	BP5ES	6511
12647-6771-1	BPR6HS	7022
12681-6774-1	BR5ES	4722
12691-6771-1	BCPR4ES-11	2378
12863-6771-1	BP5ES	6511
12866-6771-1	BP5ES	6511
12992-6771-1	BPR5ES	7422
13078-6771-6	BP6ES	7811
13157-6771-2	BM4A	5628
13211-6771-6	B-4	3210
13281-6771-6	B-4H	4110
13301-6771-6	AB-2	3020
13373-6774-1	BMR4A	5728
13374-6774-1	BPR4HS	7823
13375-6774-0	BP5ES	6511
13375-6774-1	BPR4HS-10	5024
13401-6771-6	B6S	3510
13412-6771-6	B7S	3710
13451-6771-6	B6HS	4510
13581-6771-6	B7HS	5110
13582-6771-1	B6HS	4510
13641-6771-1	B-4H	4110
13661-6771-1	BP-2H	3211
13901-6771-6	BP6HS	4511
13979-6771-1	BP4HS	3611
15204-6551-1	Y-110	6825
15221-6551-2	Y-106-1	6525
15221-6551-3	Y-106-1	6525
15261-6551-4	Y-103K	6325
15451-6551-1	Y-203	2532
15521-6551-2	Y-106V	6926
15694-6551-3	Y-702R	1065
15806-6551-3	Y-706R	3041
15951-6551-3	Y-103V	2031
16241-6551-2	Y-709R	3238
16281-6551-1	YE11	97505
16851-6551-1	YE01	2649
16851-6551-2	YE01	2649
17331-6551-1	Y-119V	7465
19077-6551-2	Y-716RS	4693
19215-6551-3	Y-149	6766
YF04/95Y4	YE01	2649

LD	VOIR TORCH	
1 072 100 089	Y-924J	7906

LOMBARDINI	NGK	N° STOCK
1 072 100 089	Y-924J	7906

MARCHAL	VOIR VALEO	
907 9Q0 330 000	B6ES	7310
907 9Q0 330 100	B7ES	1111
907 9Q0 330 200	B8ES	2411
907 9Q0 330 300	B9ES	2611
907 9Q0 330 400	B6HS	4510
907 9Q0 330 500	B7HS	5110
907 9Q0 330 600	B8HS	5510
907 9Q0 330 700	B9HS	5810
907 9Q0 330 800	BR7ES	5122
907 9Q0 330 900	BR8ES	5422
907 9Q0 331 000	BR9ES	5722
907 9Q0 331 100	BR6HS	3922
907 9Q0 331 200	BR7HS	4122
907 9Q0 331 300	BR8HS	4322
907 9Q0 331 400	BR9HS	4522
907 9Q0 331 500	BPR6HS	7022
907 9Q0 331 800	CR8E	1275
907 9Q0 331 900	CR9E	6263
907 9Q0 332 100	DPR8EA-9	4929

MBK	NGK	N° STOCK
33-104	BR7ES	5122
33-11458M	B6HS-10	1052
33-12127	BP6HS-10	6326
33-123	BR6ES	4922
33-12343	BP8HS-10	3823
33-12343B	BP8HS-10	3823
33-136862	BU8H	6431
33-136862B	BU8H	6431
33-13686Q	BU8H	6431
33-14	BP5S	3011
33-14103550	BUZHW	2147
33-14103568	BUZ8H	7447
33-14103570	BUZHW-2	2173
33-14103Q	BUZHW-2	2173
33-14814548	BPZ8HS-10	3133
33-14814568	BPZ8HS-15	3180
33-14814Q	BPZ8HS-10	3133
33-17719547	BPR7HS-10	1092
33-18	BPR4FS-11	2527
33-18S	BPR4FS-11	2527
33-19424	BP8HS-15	6729
33-19796	BPR6HS-10	2633
33-306	B6HS	4510
33-312	BP6HS-10	6326
33-327	BPR6HS	7022
33-328	BP7HS	5111
33-400S	BR6FS	4323
33-401	BP6EFS	3812
33-406	BPR6FS	2623
33-41263B	B7HS-10	2129
33-41263M	B7HS-10	2129
33-592	BR6S	3522
33-59571	BR6FS	4323
33-59571B	BR6FS	4323
33-63	BP5S	3011
33-803507	DCPR6E	3481
33-803991	BR6FIX	2318
33-807C	B8HS	5510
33-807S	B8HS	5510
33-809679	BR9ES	5722
33-809679B	BR9ES	5722
33-809680	BR8ES	5422
33-809680B	BR8ES	5422
33-810883	BPR6ES	7822
33-811	B7HS	5110
33-811S	B7HS	5110
33-8134101	UR5	2771
33-813413	B7S	3710
33-8134141	BP7HS	5111

33-813415	B8S	3810
33-813418	BR9HS-10	4551
33-8134214	R5673-8	4140
33-813423	BPR6HS	7022
33-813469	B6S	3510
33-8134711	BR6ES	4922
33-813472	BR6HS	3922
33-814	BPR7HS-10	1092
33-816336	BPR6EFS	3623
33-816336Q	BPR6EFS	3623
33-8167372	BP8H-N-10	4838
33-8167372B	BP8H-N-10	4838
33-816737Q	BP8H-N-10	4838
33-8168372	BPZ8H-N-10	4495
33-8168372B	BPZ8H-N-10	4495
33-816837Q	BP8H-N-10	4838
33-818	BR9ES	5722
33-818S	BR9ES	5722
33-821916	BR7HS	4122
33-821C	B9HS-10	3626
33-821S	B9HS-10	3626
33-823	B6S	3510
33-82370M1	B6HS	4510
33-82371B	B7HS	5110
33-82371M	B7HS	5110
33-82372M	B8HS	5510
33-823S	B6S	3510
33-824	BUHX	2522
33-8244068	BR8HS-10	1134
33-825C	B7S	3710
33-825S	B7S	3710
33-827858	DPR6EA-9	5531
33-827858Q	DPR6EA-9	5531
33-827859	CR6HSA	2983
33-827C	BUHW	2622
33-827S	BUHW	2622
33-828942	BR7HS-10	1098
33-828C	BZ7HS-10	3579
33-828S	BZ7HS-10	3579
33-833C	BUHW-2	5626
33-833S	BUHW-2	5626
33-838	BUZHW-2	2173
33-841C	B6S	3510
33-843220Q	IZFR6J	4462
33-84409B	B8HS-10	5126
33-84409M	B8HS-10	5126
33-84675M	B5HS	4210
33-8556721	PZFR5F-11	4363
33-8557171	ZFR5F-11	2262
33-859495	LFR5A-11	6376
33-859495Q	LFR5A-11	6376
33-862029	TR5IX	7397
33-863622001	PZTR5A-15	7862
33-874	BR7HS	4122
33-876	BUZ8H	7447
33-880	BR8ES	5422
33-881284	LFR6A-11	3672
33-881284Q	LFR6A-11	3672
33-883	BR7HS	4122
33-883323001	DCPR7E	3932
33-885C	BU8H	6431
33-885S	BU8H	6431
33-886	BUZ8H	7447
33-889246Q39	ILFR6G-E	4212
33-889597Q	IZFR5G	5887
33-892567Q	IZFR5J	5899
33-896	B5HS	4210
33-896323	B7HS	5110
33-896329818	BR9ES	5722
33-896329874	BR7HS	4122
33-898	BUZHW	2147
33-898264001	BR6FS	4323
33-898829001	LFR4A-E	6499
33-8M0046007	TR5IX	7397

À TITRE INDICATIF

33-8M0057936	ZFR5F	5165
33-8M2018369	ITR4A15	5599
33-918	ZFR6F-11	4291
33-924	BP8HS-15	6729
33-936C	BP8HS-10	3823
33-936S	BP8HS-10	3823
33-938	BPZ8HS-10	3133
33-939	BPZ8HS-15	3180
33-941	BR8HS	4322
33-97180	BUHW	2622
33-97180B	BUHW	2622
33-97180Q	BUHW	2622
33-97182	BUHW-2	5626
33-97182B	BUHW-2	5626
33-97182Q	BUHW-2	5626
33-97184	BP7HS-10	7829
33-97186	B9HS-10	3626
33-97186B	B9HS-10	3626

MERCURY	NGK N° STOCK	
8M0006613	ILFR6G-E	4212
8M0007910	IZFR7M	4214
8M0007919	IZFR7M	4214

mitsubishi	NGK N° STOCK	
801001	B-4	3210
801033	B7HS	5110
30666-57301	Y-114T	6528
30666-57302	Y-114T	6528
30666-57303	Y-114T	6528
30L66-00300	Y-723R	3460
30L66-00301	Y-723R	3460
30L66-00302	Y-723R	3460
30L66-00400	Y-723U	3818
30L66-004009V	Y-723U	3818
30L66-00401	Y-723U	3818
30L66-00402	Y-723U	3818
32A6603100	Y-110	6825
34466-21300	Y-182T	2163
34466-21301	Y-182T	2163
34466-31301	Y-182T1	5619
EE96002	Y-104	6425
MD 070194	Y-707RS	4937
MD 077167	Y-707RS	4937
MD 313 442	PFR5G-11	2647
MD 313 443	PFR6G-11	5555
MD 314 766	BKR7EKC-N	2095
MD 319 517	PFR6G	4793
MD 320 543	BKR7EKC-N-11	5772
MD 320 572	BKR5E	7938
MD 321 150	BKR6EKC-N-11	2284
MD 322 771	PFR6B-11	4014
MD 338 492	BPR4ES	7222
MD 357 531	PFR6J	2645
MD 375 642	BKR5ETUA	5548
ME 017010	Y-274	2165
ME 017013	Y-274	2165
MM 401621	Y-110	6825
MM 40162101	Y-110	6825
MM 40162102	Y-110	6825
MM 431439	Y-142T	5473
MM 43143901	Y-142T	5473
MS 851 022	BP5ES	6511
MS 851 023	BP6ES	7811
MS 851 024	BP7ES	2412
MS 851 027	BP5ES-11	7311
MS 851 028	BP6ES-11	1212
MS 851 029	BP7ES-11	2712
MS 851 097	BP5EY	7327
MS 851 101	BP4EY	1028
MS 851 102	BP5EY	7327
MS 851 104	BP6EY	7727
MS 851 106	BP4EY-11	3928
MS 851 107	BP5EY-11	4028

MS 851 108	BP6EY-11	4128
MS 851 111	B-4	3210
MS 851 113	B6S	3510
MS 851 121	BP-4	2911
MS 851 126	BPR6E	6464
MS 851 132	B5HS	4210
MS 851 133	B6HS	4510
MS 851 134	B7HS	5110
MS 851 162	B5ES	6410
MS 851 163	B6ES	7310
MS 851 164	B7ES	1111
MS 851 165	B8ES	2411
MS 851 174	BR7ES	5122
MS 851 181	BP4ES	6928
MS 851 182	BP5ES	6511
MS 851 182 A	BP5ES	6511
MS 851 183	BP6ES	7811
MS 851 184	BP7ES	2412
MS 851 187	BP5ES-11	7311
MS 851 188	BP6ES-11	1212
MS 851 189	BP7ES-11	2712
MS 851 192	BP6ES	7811
MS 851 207	BP5ES-11	7311
MS 851 208	BP6ES-11	1212
MS 851 212	BP5ES	6511
MS 851 213	BP6ES	7811
MS 851 215	BP7ES	2412
MS 851 217	BPR5ES	7422
MS 851 218	BPR6ES	7822
MS 851 219	BPR7ES	2023
MS 851 227	BPR5ES-11	4424
MS 851 228	BPR6ES-11	4824
MS 851 229	BPR7ES-11	7226
MS 851 230	BPR4ES-11	4224
MS 851 232	BPR5ES	7422
MS 851 233	BPR6ES	7822
MS 851 234	BPR7ES	2023
MS 851 235	BPR5ES	7422
MS 851 236	BPR6ES	7822
MS 851 237	BPR5ES-11	4424
MS 851 238	BPR6ES-11	4824
MS 851 239	BPR7ES-11	7226
MS 851 242	BP4EY	1028
MS 851 243	BP5EY	7327
MS 851 244	BP6EY	7727
MS 851 246	BP4EY-11	3928
MS 851 247	BP5EY-11	4028
MS 851 248	BP6EY-11	4128
MS 851 253	BUR6EA-11	5428
MS 851 254	BUR7EA-11	7031
MS 851 272	BUR5EA-11	1180
MS 851 273	BUR6EA-11	5428
MS 851 274	BUR7EA-11	7031
MS 851 283	BP6E	7529
MS 851 286	BP5EY	7327
MS 851 287	BP6EY	7727
MS 851 316	DCPR6E	3481
MS 851 317	DCPR7E	3932
MS 851 327	DCPR7EIX	6046
MS 851 332	PFR6B-11	4014
MS 851 335	PFR5J-11	4642
MS 851 336	PFR6J-11	2743
MS 851 351	BK5E	6233
MS 851 352	BK6E	3536
MS 851 353	BK6E	3536
MS 851 354	BK5E	6233
MS 851 357	BKR5E-11	6953
MS 851 358	BKR6E-11	2756
MS 851 359	BKR7E-11	1283
MS 851 361	BK5E-11	6234
MS 851 362	BK6E-11	7340
MS 851 363	BK7E-11	7341
MS 851 364	BK5E-11	6234
MS 851 365	BK6E-11	7340

MS 851 366	BK7E-11	7341
MS 851 367	BKR5E	7938
MS 851 368	BKR6E	6962
MS 851 382	BKR6E	6962
MS 851 387	BKR5E-11	6953
MS 851 388	BKR6E-11	2756
MS 851 396	DCPR6E	3481
MS 851 397	DCPR7E	3932
MS 851 402	BPR5E	7075
MS 851 403	BPR6ES-11	4824
MS 851 408	BPR6ES-11	4824
MS 851 412	BPR5ES	7422
MS 851 413	BPR6ES	7822
MS 851 414	BPR7ES	2023
MS 851 417	BPR5ES-11	4424
MS 851 418	BPR6ES-11	4824
MS 851 419	BPR7ES-11	7226
MS 851 428	BUR6EA-11	5428
MS 851 429	BUR7EA-11	7031
MS 851 437	BP5EY	7327
MS 851 438	BP6ES	7811
MS 851 439	BP7ES	2412
MS 851 447	BUR6EA-11	5428
MS 851 448	BUR5EA-11	1180
MS 851 454	BR7ES	5122
MS 851 478	BPR6ES-11	4824
MS 851 486	DCPR6E	3481
MS 851 487	DCPR7E	3932
MS 851 497	DCPR7EIX	6046
MS 851 501	PFR5J-11	4642
MS 851 502	PFR6J-11	2743
MS 851 506	PFR6J	2645
MS 851 721	BK5E	6233
MS 851 722	BK6E	3536
MS 851 727	BKR5E-11	6953
MS 851 728	BKR6E-11	2756
MS 851 729	BKR7E-11	1283
MS 851 732	BK6E-11	7340
MS 851 737	BKR5E	7938
MS 851 738	BKR6E	6962
MS 851 783	BK7EK-N-11	2090
MS 851 861	PFR6J	2645
MS 851 872	BK7EK-N-11	2090
MS 851 881	BPR6EKN	1128
MS 851 882	BPR7EKN	7738
MZ 602 020	BKR5EIX-11	5464
MZ 602 021	BKR6EIX-11	3764
MZ 602 026	BCPR5EIX-11	3306
MZ 602 027	BCPR6EIX-11	4919
MZ 602 032	BPR5EIX-11	2115
MZ 602 033	BPR6EIX-11	3903
MZ 602 034	BPR7EIX	4055
MZ 602 035	BR8EIX	5044
MZ 602 036	BR9EIX	3981
MZ 602 037	DCPR7EIX	6046
MZ 602 041	BKR6EIX-11P	2574
MZ 602 043	BCPR5EIX-11P	3215
MZ 602 044	BCPR6EIX-11P	4174
MZ 602 049	DCPR7EIX-P	5175
MZ 602 060	BPR5EIX-11	2115
MZ 602 061	BPR6EIX-11	3903
MZ 602 062	BPR7EIX	4055
MZ 602 063	BCPR5EIX-11	3306
MZ 602 064	BCPR6EIX-11	4919
MZ 602 065	BKR5EIX-11	5464
MZ 602 066	BKR6EIX-11	3764
MZ 602 067	DCPR7EIX	6046
MZ 602 070	BPR5EIX	6597
MZ 602 071	BPR6EIX	6637
MZ 602 072	BKR5EIX	6341
MZ 602 073	BKR6EIX	6418
MZ 602 077	BKR6EIX-11P	2574
MZ 602 078	BCPR5EIX-11P	3215
MZ 602 079	BCPR6EIX-11P	4174

MZ 602 080	DCPR7EIX-P	5175
MZ 602 081	BKR7EIX-11	6988
SM D31 344 3	PFR6G-11	5555
SS MS8 513 64	BK5E-11	6234
Z 2152 944	BPR6ES-11	4824
Z 2152 945	BPR6ES	7822
Z 2152 946	BR7ES	5122
Z 2152 947	BPR7ES	2023
Z 2152 948	BPR7ES-11	7226
Z 2152 949	BCPR7ES-11	1095
Z 2152 950	BCPR6ES-11	7121

NGK	NGK N° STOCK	
A-6	AB-6	2910
A-7	AB-7	3010
A-8	AB-8	7909
A8V	AB-8	7909
A9EFP	Supprimée	/
A9FS	Supprimée	/
A9V	Supprimée	/
AU10EFP	Supprimée	/
B5EB	BR5ES	4722
B5ES11	B5ES	6410
B6EB	BR6ES	4922
B6EB11	BUR6EB-11	5730
B6EBL11	BR6EB-L-11	7028
B6EFS	BR6EF	3177
B6ET	B6EM	2921
B6EV	B6EVX Supprimée	/
B6EVX	Supprimée	/
B6FS	BR6FS	4323
B6HV	BR6HIX	3419
B6HVX	BR6HIX	3419
B7EB	BR7ES	5122
B7EB11	BUR7EB-11	6832
B7ET	BR7ET	4121
B7EV	BR7EIX	6664
B7EVX	BR7EIX	6664
B7HV	BR7HIX	7067
B7HVX	BR7HIX	7067
B8EM	Supprimée	/
B8EMV	BR8ET	4221
B8EN	B8EGV	5627
B8ES11	B8ES	2411
B8ET	BR8ET	4221
B8EV	BR8EIX	5044
B8EVX	BR8EIX	5044
B8HN	R5525-8	7383
B8HSA	BP8HS	2630
B8HV	BR8HIX	7001
B8HVX	BR8HIX	7001
B9EGP	R7376-9	7763
B9EM	Supprimée	/
B9EN	B9EGV	5827
B9EV	BR9EIX	3981
B9EVX	BR9EIX	3981
B9HN	R5525-9	3914
B9HP	R5530-9	4016
B9HV	BR9HIX	5687
B9HVX	BR9HIX	5687
B10EV	BR10EIX	6801
B10EVX	BR10EIX	6801
B10H	B10HS	2399
B10HN	R5525-10	2098
B10HP	R5530-10	6366
B10HV	BR10HIX	6692
B10HVX	BR10HIX	6692
B11EN	B11EGV	5831
B11HN	R5525-11	2844
B11HP	R5525-11	2844
B77C	B8S	3810
B77EC	B8ECS	2821
B77HC	B8HCS	2621
B410	B-4	3210

À TITRE INDICATIF

Y-207TS	Y-207T	1239
Y-209	Supprimée	/
Y-212	Supprimée	/
Y-302	Supprimée	/
Y-403-1	Supprimée	/
Y-720U	Y-720U1	5392
Y-902R	Y-924J	7906
Y-904R	Y-904R1	90958
Y-908R	Y-924J	7906
Y-914U	Y-924J	7906
Y-917U	Y-924J	7906
Y-920R	Y-924J	7906
Y-922R	Y-924J	7906
Y-923U	Y-924J	7906
Y-924U	Y-924J	7906
Y-938R	Y-924J	7906
YS-101	Supprimée	/

NHSP VOIR TORCH

NISSAN	NGK N° STOCK	
11065-10G00	Y-705RS	1249
11065-10T01	Y-757RS	4018
11065-31W00	Y-112T	6327
11065-31W01	Y-112T	6327
11065-31W02	Y-112TS	1232
11065-43G01	Y-707RS	4937
11065-63G00	Y-707RS	4937
11065-63G00-GW	Y-707RS	4937
11065-37506	Y-103	6125
11065-37507	Y-103	6125
11065-C8600	Y-755RS	7771
11065-J2000	Y-202	1226
11065-J5501	Y-202-2	3226
11065-J5502	Y-202-2	3226
11065-J5570	Y-222T	7628
11065-Q4001	Y-112T1	6728
11065-T3400	Y-177-1	3026
11065-T3401	Y-177-1	3026
11065-T8200	Y-112R1	1032
11065-T8201	Y-162R1	2431
11065-T8202	Y-112R1	1032
11065-T8203	Y-162R1	2431
11065-V0700	Y-204TS1	3829
11065-V0710	Y-204TS1	3829
11065-Y1400	Y-103-1	6225
11065-Y1401	Y-103-1	6225
11065-Y1402	Y-103-2	2926
11065-Y1403	Y-103-2	2926
11065-Y1404	Y-103-2	2926
11065-Z5000	Y-252	2126
22401-01B14	BPR5ES-11	4424
22401-01M14	BP4ES-L-11	2065
22401-01P14	BCPR4ES-11	2378
22401-01P15	BCPR5ES-11	3524
22401-01P16	BCPR6ES-11	7121
22401-01P17	BCPR7ES-11	1095
22401-01P75	BCPR5ES-11	3524
22401-01P76	BCPR6ES-11	7121
22401-01P90	BCPR5ES-11	3524
22401-01P91	BCPR6ES-11	7121
22401-02P15	BCPR5E-11	1273
22401-02P16	BCPR6E-11	3132
22401-02P17	BCPR7E-11	1267
22401-03300	B-4	3210
22401-10F14	BCPR4ES-11	2378
22401-10F15	BCP5ES	7496
22401-10F16	BCP6ES	4930
22401-10F17	BCP7ES	5030
22401-10P15	BCPR5E-11	1273
22401-10P16	BKR6E-11	2756
22401-10P17	BCPR7E-11	1267
22401-11200	BC6ES	3312
22401-12E14	BCPR4ES-11	2378

22401-12E15	BCPR5ES	6130
22401-12E16	BCPR6ES	2330
22401-12E17	BCPR7ES	3330
22401-12E76	BCPR6ES	2330
22401-19V15	BCP5ES	7496
22401-19V16	BCP6ES	4930
22401-19V17	BCP7ES	5030
22401-19V65	BCPR5ES	6130
22401-19V66	BCPR6ES	2330
22401-1P116	PFR6G-11	5555
22401-20J05	BKR5E	7938
22401-20J06	BKR6E	6962
22401-21B15	BPR5E	7075
22401-2J200	BKR5EY-11	2355
22401-2J206	BKR6EY-11	4368
22401-37P16	PFR6B-11C	2684
22401-50Y05	BKR5E-11	6953
22401-53J05	BKR5EY	7390
22401-53J06	BKR6EY	3696
22401-53J65	PFR5B-9	2392
22401-53J66	PFR6B-9	3100
22401-53V17	PFR7B	4853
22401-85E16	BKR6ES-11	5553
22401-97E65	PFR5C-11	2271
22401-AG215	PFR5P-11	4341
22401-F6516	PFR6A-11	4045
22401-FU412	FR2A-D	4768
22401-M7915	BR5ES	4722
22401-P8316	BPR6ES-11	4824
22401-P8616	BR6ES-11	3824
22401-V0516	BP6ES	7811
22401-V1415	BPR5ES	7422
22401-V1416	BPR6ES	7822
BY480-DCPR7	DCPR7EIX	6046
BY484-DCPR7	DCPR7EIX-P	5175

OMC NGK N° STOCK

115 206	BP6HS	4511
387 694	B7HS	5110
437 929	BPR7HS	6422
445 098	D6HA	6512
502 177	B6HS	4510
502 194	B7HS-10	2129
502 196	BR6S	3522
502 894	BUZ8H	7447
503 948	BPR6HS	7022
503 949	BR6HS	3922
503 950	BR6HS	3922
504 082	BR6HS	3922
509 921	BUHW	2622
509 922	BUHW-2	5626
509 924	BUZ8H	7447
509 925	BZ7HS-10	3579
509 926	BUHXW-1	5526
509 928	B6S	3510
509 929	B7HS	5110
584 918	DCPR7E	3932
771 770	BUZHW-2	2173

OREGON VOIR BRISK

PEUGEOT NGK N° STOCK

7567.67	CPR8EB-9	6607
---------	-----------------	-------------

PIAGGIO NGK N° STOCK

641 387	ER9EH-6N	1673
---------	-----------------	-------------

POLARIS NGK N° STOCK

3 021 559	BPR4EY	2128
3 021 671	BKR7E	6097
3 022 274	MR7F	95897
3 022 462	MR7F	95897
3 022 559	MR7F	95897

3 022 639	MR7F	95897
3 070 156	BR8ES	5422
3 070 167	BPR8ES	3923
3 070 172	BKR6E	6962
3 070 175	BKR5E	7938
3 070 195	BKR7E	6097
3 085 784	BKR7E	6097
3 088 051	DCPR8E	4339
0 450 005	BPR7HS	6422

ROBIN NGK N° STOCK

065-01403-60	BP-2H	3211
--------------	--------------	-------------

SHINDAIWA NGK N° STOCK

62088-7130	BPMR8Y	2218
------------	---------------	-------------

SPECTRA NGK N° STOCK

102 431	B8HS	5510
102 432	B7HS	5110
102 433	B6HS	4510
102 434	B5HS	4210
102 543	B6S	3510
102 544	B-4	3210
102 553	B4-LM	3410
102 554	B2-LM	1147
102 653	BM6A	5921
102 763	BM6F	6221
103 102	BP6ES	7811
103 103	BP5ES	6511
103 432	BP6HS	4511
103 653	BPM6A	7021
107 101	BPR7ES	2023
107 102	BPR6ES	7822
107 103	BPR5ES	7422
107 213	BCPR5ES	6130
107 431	BR7HS	4122
107 432	BPR7HS	6422
107 433	BR6HS	3922
107 553	BR4-LM	4133
107 554	BR2-LM	5798
107 653	BMR6A	7421
107 654	BPMR6A	6726
107 655	BPMR7A	4626

SUBARU NGK N° STOCK

320 540 800	B6ES	7310
320 541 110	B7ES	1111
320 541 120	BR7EIX	6664
320 545 700	BR6ES	4922
380 280 102	BP6EY	7727
382 420 800	B5ES	6410
420 543 200	BP5ES	6511
420 545 502	BP6ES	7811
420 545 602	BP5EY-11	4028
420 545 702	BP6ES-11	1212
420 545 800	BE529Y-11	5929
420 545 802	BE529Y-11	5929
420 547 102	BP5EY	7327
420 547 302	BP5EY-11	4028
480 287 100	BP4EY-11	3928
490 010 013	BPR6EIX	6637
490 010 023	BPR7EIX	4055
490 010 033	BPR5ES	7422
490 010 043	BP5EY	7327
490 010 053	BP6EY	7727
490 010 082	BPR5EY	2828
490 010 092	BPR6EY	6427
820 541 810	B6HS	4510
820 541 812	B6HS	4510
820 546 010	B8HS	5510
820 547 820	BR6HIX	3419
820 548 020	BR8HIX	7001
820 548 600	B6ES	7310

820 549 310	B7HS	5110
820 549 312	B7HS	5110
820 549 320	BR7HIX	7067
882 417 800	B5HS	4210
890 573 400	B6S	3510
22401 AA000	BP5ES-11	7311
22401 AA010	BP6ES-11	1212
22401 AA020	BP6ES	7811
22401 AA030	BP6ES	7811
22401 AA080	BP6EY	7727
22401 AA090	BP7ES	2412
22401 AA100	BE527Y-11	5930
22401 AA110	BE527Y-11	5930
22401 AA120	BPR6ES-11	4824
22401 AA130	BPR6ES-11	4824
22401 AA200	BPR6ES	7822
22401 AA210	BPR7ES	2023
22401 AA220	BPR6ES	7822
22401 AA230	BPR7E	1142
22401 AA310	BKR6E-11	2756
22401 AA320	BKR6E-11	2756
22401 AA360	PFR7B	4853
22401 AA370	PFR6B-11	4014
22401 AA380	BRE527Y-11	6029
22401 AA390	BRE527Y-11	6029
22401 AA400	PFR6G	3500
22401 AA460	BPR5EY-11	3028
22401 AA470	BPR6EY-11	4228
22401 AA480	BPR5ES-11	4424
22401 AA500	BKR6EIX-11	3764
22401 AA510	BKR6EIX	6418
22401 AA520	PFR6G-11	5555
22401 AA530	PFR6G	4793
22401 AA531	PFR6G	4793
22401 AA570	PFR5B-11	2300
22401 AA600	PFR7G	4364
22401 KA000	BUR6EA-11	5428
22401 KA010	BKR6E-11	2756
22401 KA030	BKR6E-11	2756
22401 KA050	BUR6EA-11	5428
22401 KA060	BUR6EA-11	5428
22401 KA080	BKR6E	6962
22401 KA090	BCPR6E	1269
22401 KA100	BCPR6E	1269
22401 KA130	BPR6ES	7822
22401 KA150	BKR6E	6962
22401 KA190	BPR5E-11	6953
22401 KA200	BKR5E-11	6953
22401 KA210		

À TITRE INDICATIF

SUZUKI	NGK	N° STOCK
09482-00123	BP5EY	7327
09482-00125	BPR-4H	7623
09482-00128	B6ES	7310
09482-00130	BP4EY	1028
09482-00144	D8EA	2120
09482-00145	D8EA	2120
09482-00149	DR8ES-L	2923
09482-00155	BPR5ES	7422
09482-00159	BPR4EY	2128
09482-00167	BPR5EY	2828
09482-00171	BP4HS	3611
09482-00181	BR10EIX	6801
09482-00182	D7EA	7912
09482-00183	D7EA	7912
09482-00184	D9EA	2420
09482-00185	D9EA	2420
09482-00186	BP-4H	3311
09482-00188	BP6HS	4511
09482-00189	BP7HS	5111
09482-00190	B6HS	4510
09482-00191	B7HS	5110
09482-00192	B8HS	5510
09482-00195	B7ES	1111
09482-00196	B8ES	2411
09482-00206	BPR4HS	7823
09482-00208	B8EGV	5627
09482-00209	B9EGV	5827
09482-00210	B10EGV	5927
09482-00216	BP4EY-11	3928
09482-00217	BP5EY-11	4028
09482-00220	DR7ES	3123
09482-00221	DR8ES	5423
09482-00222	DR7EA	7839
09482-00223	DR8EA	7162
09482-00227	CM-6	5812
09482-00233-111	BR9ES	5722
09482-00234	DR9EA	3437
09482-00240-111	BPR8ES	3923
09482-00244-111	BPR7HS	6422
09482-00247-111	BR8ES	5422
09482-00258	BPMR6A	6726
09482-00260	BPM4A	5928
09482-00261	BPMR4A	6028
09482-00284	BP6EY-11	4128
09482-00285	BPR6ES-11	4824
09482-00286	BPR6EY-11	4228
09482-00295	C6HSA	3228
09482-00299	BPR6ES	7822
09482-00302-111	BPR6HS	7022
09482-00303	BP6EY-11	4128
09482-00305	BP5HS	4111
09482-00306	BPR6HS	7022
09482-00308	BR5HS	3722
09482-00312	BPR5EY-11	3028
09482-00314	CR7HSA	4549
09482-00320-111	CR8HSA	2086
09482-00321	C8HSA	6821
09482-00331-111	DPR7EA-9	5129
09482-00333-111	DP8EA-9	5829
09482-00335-111	DPR7EA-9	5129
09482-00340	CR6HS	7023
09482-00351	B9ES	2611
09482-00355-111	DPR7EA-9	5129
09482-00360	BR10ES	4832
09482-00363	BPR5EY	2828
09482-00368	DCP7E	2363
09482-00369	DCP7E	2363
09482-00378	DCPR8E	4339
09482-00386	DCPR7EIX	6046
09482-00387	DCPR7EIX	6046
09482-00392	BP6ES	7811
09482-00393	DCP6E	2256

09482-00394	DCP6E	2256
09482-00398	DR7EA	7839
09482-00399	DR8EA	7162
09482-00400	DR9EA	3437
09482-00406-000	CR6HSA	2983
09482-00407	CR6HSA	2983
09482-00408	CR7HSA	4549
09482-00410	CR9EK	4548
09482-00411	CR9EK	4548
09482-00412	CR8EK	3478
09482-00413	CR8EK	3478
09482-00414	CR7EK	7546
09482-00416-111	BPR5HS	6222
09482-00420-111	BPR-4H	7623
09482-00421	BPR6ES-11	4824
09482-00434	BP7ES	2412
09482-00446	DCPR6E	3481
09482-00447	DCPR6E	3481
09482-00448	DCPR7E	3932
09482-00449	DCPR7E	3932
09482-00456	CR8E	1275
09482-00457	CR8E	1275
09482-00458	CR9E	6263
09482-00459	CR9E	6263
09482-00460	CR10E	6264
09482-00461	CR10E	6264
09482-00462	CR10EK	2360
09482-00463	CR10EK	2360
09482-00468	BPR5E	7075
09482-00470	BR8ECM	3035
09482-00472	BR9ECM	3252
09482-00473	BR9ECM	3252
09482-00474	BR10ECM	4234
09482-00476	BKR5E	7938
09482-00478	B10ES	7928
09482-00479	DCPR7EIX	6046
09482-00482	DCPR7EIX	6046
09482-00484	DCPR8EIX	6546
09482-00485	CR8HSA	2086
09482-00488	DCPR7E	3932
09482-00494	BKR6E-11	2756
09482-00496	BPR5E-11	5638
09482-00497	BKR5E-11	6953
09482-00498	BPR7ES	2023
09482-00501	BPR6EY	6427
09482-00504	BPR5EY	2828
09482-00508	BKR6E-11	2756
09482-00515	CR7E	4578
09482-00516	CR7E	4578
09482-00526	BR10EYA	7613
09482-00528	CR6E	6965
09482-00537	DCPR9EIX	2316
09482-00540	PFR5G-11	2647
09482-00556	CR8EIA-9	4286
09482-00557	CR9EIA-9	6289
09482-00558	CR9EIA-9	6289
09482-00561	BR8EG	3130
09482-00570	CR8EB	7784
09482-00581	CR8EKB	4374
09482-00582	CR9EKB	2305
09482-00584	CR8EIB-10	4948
09482-00597	CR8EIA-10	4708
09482-00600	DIMR8A10	5066
09482-00612	MR8A19	7692
09482-00635	LMAR8BI-9	91909
09482-00L01	CR6E	6965
09482-00L02	CR6HSA	2983
09482-00L04	CPR6EA-9	6899
94820-01197	B9ES	2611
99000-69571	C7HSA	4629
99000-69835-BR1	BR10EIX	6801
99000-69835-C6R	CR6HIX	7274
99000-69835-C7R	CR7HIX	7544
99000-69835-C8R	CR8HIX	7669

99000-69835-CR7	CR7EIX	7385
99000-69835-CR8	CR8EIX	4218
99000-69835-DC8	DCR8EIX	3606
99000-69835-DR8	DR8EIX	6681
99000-69835-DR9	DR9EIX	4772
99000-79A37-16E	BPR5EIX	6597
99000-79A37-20F	BR6HIX	3419
99000-79A37-22E	BR7EIX	6664
99000-79A37-24E	BR8EIX	5044
99000-79A37-24R	BR8EIX	5044
99000-79A37-27R	BR9EIX	3981
99000-79A37-29E	BR10EIX	6801
99000-79A37-31E	BR10EIX	6801
99000-79A37-K0P	BKR6EIX-11	3764
99000-79A37-U2F	CR7HIX	7544
99000-79A37-U4R	CR8HIX	7669
99000-79A37-U7E	CR9EIX	3521
99000-79A37-W6X	BPR5EIX	6597
99000-79A45-B0E	BR10EIX	6801
99000-79B56	BPR4EY-11	1143
99000-79J80-K16	BKR5EIX-11	5464
99000-79J80-K20	BKR6EIX-11	3764
99000-79J80-U22	DCPR7EIX	6046
99000-79J80-W16	BPR5EIX-11	2115
99000-79J80-W20	BPR6EIX-11	3903
99000-79J80-W22	BPR7EIX	4055
99000-79K24-22B	DPR7EIX-9	7803
99000-79K24-24B	DPR8EIX-9	2202
99000-79K24-27B	DPR9EIX-9	5545
99000-79K24-F22	CR7HIX	7544
99000-79K24-F24	CR8HIX	7669
99000-79K24-H24	CR8EHIX-9	3797
99000-79K24-H27	CR9EHIX-9	6216
99000-79K24-IW4	BR8EIX	5044
99000-79K24-IW7	BR9EIX	3981
99000-79K24-U22	CR7EIX	7385
99000-79K24-U24	CR8EIX	4218
99000-79K24-U27	B8HCS	2621
99000-79K24-W22	BR7HIX	7067
99000-79K24-W24	BR8HIX	7001
99000-79K24-W27	BR9HIX	5687
99000-79K24-W31	BR10EIX	6801
99000-79K24-X24	DR8EIX	6681
99000-79K24-X27	DR9EIX	4772
99000-79K60-DC7	DCPR7EIX	6046
99000-79K73-K20	BKR6EIX-11P	2574
99000-79K73-U22	DCPR7EIX-P	5175
99000-79L65-004	DCPR7EIX-P	5175

TNT VOIR TORCH

TORCH	NGK	N° STOCK
8012	BPR6EIX	6637
A6RTC	CR6HSA	2983
A6TC	C6HSA	3228
A7RTC	CR7HSA	4549
A7T	C7HSA	4629
A7TC	C7HSA	4629
A8RTC	CR8HSA	2086
A8TC	C8HSA	6821
B8RC	CR8E	1275
C6RTC	D6HA	6512
C6TC	D6HA	6512
D6RTC9	DPR6EA-9	5531
D7	D7EA	7912
D7CA	D7EA	7912
D7RC	D7EA	7912
D7RTC9	DPR7EA-9	5129
D7TC	DP7EA-9	5629
D8C	D8EA	2120
D8RC	DR8EA	7162
DK7RTC	DCPR7E	3932
E4RC	BR4HS	3322
E4RTC	BPR4HS	7823

E4TC	BP4HS	3611
E5TC	BP5HS	4111
E6RC	BR6HS	3922
E6RTC	BPR6HS	7022
E7C	B6HS	4510
E7RTC	BPR7HS	6422
E8RC	BR8HS	4322
E8RTC	BPR8HS	3725
F5RF	BPR5EY	2828
F5RTC	BPR5ES	7422
F5TC	BP5ES	6511
F6RF	BPR6EY	6427
F6T	BP6ES	7811
F7C	B7ES	1111
F7RC	BR7ES	5122
F7RTC	BPR7ES	2023
F8RC	BR8ES	5422
F8RTC	BPR8ES	3923
G3F	B-4	3210
G3TC	BP-4	2911
G4C	B-4	3210
G4RC	B-4	3210
G6	B6S	3510
G6C	B6S	3510
G6RC	BR6S	3522
GL4	B4-LM	3410
H5	B6S	3510
K4RTC3	ZFR5F	5165
K5RF11	BKR5E-11	6953
K5RTC11	BKR5ES-11	2382
K5TC	BKR5ES-11	2382
K6RF	BKR6ES	3783
K6RF11	BKR6E-11	2756
K6RTC11	BKR6ES-11	5553
K6TC	BKR5E	7938
K6TCOR	BKR5ES	2460
K7TC	BCP6ES	4930
K7TCOR	BKR6ES	3783
K7TJC	BCP6ET	4563
L6	BM6A	5921
L6C	BM6A	5921
L6RC	BMR6A	7421
L6RTC	BPMR6A	6726
L6T	BPM6A	7021
L6TC	BPM6A	7021
L7	BM7A	6521
L7RTC	BPMR7A	4626
L7TC	BPM7A	7321
L7Y	BM7A	6521
L8RTF	BPMR8Y	2218
N6	BM6F	6221
N6C	BM6F	6221
N6RC	BMR6F	2144
N6RTC	BPMR6F	1270
N7C	BM7F	6421
N7RC	BM7F	6421
P5RTC	BPR5FS	2423
P5TC	BP5FS	3412
P6RTC	BPR6FS	2623
P6TC	BP6FS	3512
P7RTC	BP7FS	3612
P7TC	BP7FS	3612
Q5RTC	BPR5EFS	2223
Q5TC	BP5EFS	3712
Q6RTC	BPR6EFS	3623
Q6TC	BP6EFS	3812
T1137C	C7HSA	4629

TOYOTA NGK N° STOCK

04195-34140	BP5ES	6511
04195-34150	BP6ES	7811
04195-34280	BPR5EY	2828
04195-34320	BPR5EY-11	3028
08922-01016-83	BPR5EY	2828

À TITRE INDICATIF

08922-01017-83	BPR6EY-11	4228
08922-01019-83	BPR5EY-11	3028
08922-01020-83	BCPR6EY-11	3720
19850-64020	Y-703R	3782
19850-87303-000	Y-108	6725
19850-87702-000	Y-703R	3782
19850-87801	Y-706R	3041
19850-B8010	Y-601J	92785
90048-51054	BPR5EY	2828
90048-51059	BPR6EY	6427
90048-51063	BPR5EY-11	3028
90048-51093-A	BPR5EY-11	3028
90048-51108-1	BPR6EKB-L	4687
90048-51126	BPR5EJ	3270
90048-51131	BPR5EKB	5449
90048-51131-1	BPR5EKB	5449
90048-51134	BCPR6EKD	2461
90048-51134-1	BCPR6EKD	2461
90048-51140	BPR6EKB	5451
90048-51158	BKR5E-11	6953
90080-91116	BKR6EKP-B-11	3452
90098-00835	BUHX	2522
90098-00845	BUHW	2622
90098-00855	BUHW-2	5626
90098-09026	AB-2	3020
90098-09036	B-2	3110
90098-09125	BP-2E	5411
90098-09685	BP2HS	7926
90098-09775	BP-4	2911
90098-09815	BP-4	2911
90098-14055	B4ES	4129
90098-14395	BP4EY	1028
90098-14425	BPR4EY	2128
90098-14515	BP-4H	3311
90098-14545	BPR4ES-13	2642
90098-14595	BP4EY	1028
90098-14615	BP4EY-11	3928
90098-14645	B-4H	4110
90098-14685	BPR4EY-11	1143
90098-14685	BP4HS	3611
90098-14715	B-4	3210
90098-14775	BP-4	2911
90098-14785	BPR4FS	1127
90098-14805	BPR4FS-15	2727
90098-14815	BP-4	2911
90098-16325	BPR5ES	7422
90098-16395	BP5EY	7327
90098-16415	C5HSA	4429
90098-16425	BPR5EY	2828
90098-16455	B5ES	6410
90098-16505	B5ES	6410
90098-16515	BP5HS	4111
90098-16545	BP5ES-13	4012
90098-16595	BP5EY	7327
90098-16615	BP5EY-11	4028
90098-16635	BP5EFS	3712
90098-16645	B5ES	6410
90098-16655	BUR5EB-11	3232
90098-16675	BPR5EY	2828
90098-16695	BP5EY	7327
90098-16705	BP5FS	3412
90098-16745	BPR5E	7075
90098-16775	BP5S	3011
90098-16785	BPR5FS	2423
90098-16795	BPR5FS-11	2924
90098-16805	BPR5FS-15	3124
90098-16815	BP5S	3011
90098-16865	BR5FS	4123
90098-16875	YR55IX	7588
90098-16895	BPR6EFS	3623
90098-16925	BP5HS-10	7429
90098-16935	BR5ES	4722
90098-16955	BE527Y-11	5930
90098-16975	BUR5EB-11	3232

90098-16985	BCPR5EY-11	4120
90098-17015	AB-6	2910
90098-17025	AB-6	2910
90098-20276	B6S	3510
90098-20325	BPR6ES	7822
90098-20355	BM6A	5921
90098-20395	BP6EY	7727
90098-20415	C6HSA	3228
90098-20425	BPR6EY	6427
90098-20455	B6ES	7310
90098-20465	D6EA	7512
90098-20485	D6HA	6512
90098-20495	DR6HS	4823
90098-20505	B6ES	7310
90098-20515	BP6HS	4511
90098-20525	BP6HSA	1046
90098-20545	BPR6EIX-11	3903
90098-20595	BP6EY	7727
90098-20615	BP6EY-11	4128
90098-20625	BPR6EK-A	7726
90098-20635	BP6EFS	3812
90098-20645	B6HS	4510
90098-20655	BUR6EB-11	5730
90098-20665	BPR6EY-11	4228
90098-20675	BPR6EY	6427
90098-20695	BP6ES	7811
90098-20705	BP6FS	3512
90098-20745	BPR6ES	7822
90098-20755	BUR6EA-11	5428
90098-20765	C6HSA	3228
90098-20775	BP6S	3111
90098-20785	BPR6FS	2623
90098-20865	BR6FS	4323
90098-20885	BP6EFS	3812
90098-20895	BPR6EFS	3623
90098-20905	BR6ES	4922
90098-20915	BUR6EB-11	5730
90098-20925	BP6HS-10	6326
90098-20935	BR6ES	4922
90098-20975	BUR6EB-11	5730
90098-20985	BCPR6EY-11	3720
90098-21655	BR6EB-L-11	7028
90098-21915	BR6EB-L-11	7028
90098-22015	AB-7	3010
90098-22025	AB-7	3010
90098-22276	B7S	3710
90098-22325	BPR7ES	2023
90098-22355	BM7A	6521
90098-22415	C7HSA	4629
90098-22455	B7ES	1111
90098-22465	D7EA	7912
90098-22475	DR7EA	7839
90098-22505	B7ES	1111
90098-22515	BP7HS	5111
90098-22595	BP7EY	1087
90098-22645	B7HS	5110
90098-22655	BUR7EB-11	6832
90098-22745	BPR7ES	2023
90098-22755	BUR7EA-11	7031
90098-22765	C7HSA	4629
90098-22885	BP7EFS	3526
90098-22905	BR7ES	5122
90098-22915	BUR7EB-11	6832
90098-22935	BR7ES	5122
90098-22975	BUR7EB-11	6832
90098-24125	BP8ES	2912
90098-24276	B8S	3810
90098-24465	D8EA	2120
90098-24475	DR8EA	7162
90098-24485	D8HA	7112
90098-24495	DR8HS	5123
90098-24505	B8ES	2411
90098-24645	B8HS	5510
90098-24695	BP8ES	2912

90098-24935	BR8ES	5422
90098-25305	B8EG	3430
90098-25375	BR8HIX	7001
90098-27305	B9EG	3530
90098-27465	D9EA	2420
90098-27475	DR9EA	3437
90098-27505	B9ES	2611
90098-27645	B9HS	5810
90098-27935	BR9ES	5722
90098-31305	B10EG	3630
90098-31465	D10EA	2720
90098-31505	B10ES	7928
90098-33034	BCPR5EY-11	4120
90098-34305	B11EG	2055
90098-64017	B4-LM	3410
90098-64018	B-4L	3112
90098-64032	GR4IX	7149
90098-64033	GR4IX	7149
90098-64050	BPR4ES-13	2642
90098-64065	ZFR4F-11	4043
90098-64066	ZFR4F-11	4043
90098-64112	BUR4EB-11	4534
90098-66001	BP5EY-11	4028
90098-66004	BPR5E-11	5638
90098-66005	BCPR5EY-11	4120
90098-66006	BUR5EB-11	3232
90098-66007	BP5EY-11	4028
90098-66011	DR5HS	4623
90098-66016	B-6L	3212
90098-66024	BR5HS	3722
90098-66031	BPR5EY-11	3028
90098-66032	BPR5EIX	6597
90098-66033	BPR5EIX	6597
90098-66038	BCPR5EIX-11	3306
90098-66039	BCPR5EIX-11	3306
90098-66040	BCPR5EY-11	4120
90098-66045	BCPR5EY-11	3306
90098-66047	BKR5E-11	6953
90098-66050	BPR5ES-13	3154
90098-66053	BKR5E	7938
90098-66054	BKR5EIX-11	5464
90098-66056	BKR5EYA-11	2526
90098-66058	BPR5E	7075
90098-66059	BKR5E-N-11	2391
90098-66064	PFR5J-11	4642
90098-66069	BPR5EKB	5449
90098-66070	PFR5B-11	2300
90098-66071	BKR5EYA	2087
90098-66077	BKR5EIX-11	5464
90098-66082	BCPR5E	1145
90098-66109	BPR5EJ	3270
90098-66114	BKR5EIX-11	5464
90098-66115	BCPR5EIX-11	3306
90098-66116	BPR5EIX-11	2115
90098-70001	BP6ES-11	1212
90098-70002	BUR6EA-11	5428
90098-70003	BPR6ES-11	4824
90098-70004	BPR6ES-11	4824
90098-70005	BKR6E-11	2756
90098-70007	BP6ES-11	1212
90098-70008	BPR6EFS-15	4871
90098-70023	CR6HSA	2983
90098-70024	BR6HS	3922
90098-70025	BR6S	3522
90098-70026	BP6S	3111
90098-70030	BPM6A	7021
90098-70031	BPR6EY-11	4228
90098-70032	BPR6EIX	6637
90098-70033	BPR6EIX	6637
90098-70034	BCPR6EY-11	3720
90098-70038	BCPR6EIX-11	4919
90098-70039	BCPR6EIX-11	4919
90098-70040	BKR6E-11	2756
90098-70043	BP6ES	7811

90098-70046	BCPR6EIX-11	4919
90098-70047	BKR6E-11	2756
90098-70048	BPR6EKN	1128
90098-70049	BPR6EKB-L	4687
90098-70050	BPR6EIX-11	3903
90098-70051	DCPR6E	3481
90098-70053	BKR6E	6962
90098-70054	BKR6EIX-11	3764
90098-70055	BPR6EFS-15	4871
90098-70056	BKR6EYA-11	4073
90098-70058	BPR6ES	7822
90098-70059	BKR6E-N-11	5724
90098-70060	PFR6G-11	5555
90098-70064	PFR6J-11	2743
90098-70067	BCPR6EKD	2461
90098-70069	BPR6EKB	5451
90098-70070	PFR6B-11	4014
90098-70071	BKR6EYA	2249
90098-70077	BKR6EIX-11	3764
90098-70082	BCPR6E	1269
90098-70086	PFR6J	2645
90098-70105	BPR6EKN	1128
90098-70106	BPR6HS-10	2633
90098-70114	BKR6EIX-11	3764
90098-70115	BCPR6EIX-11	4919
90098-70116	BPR6EIX-11	3903
90098-72019	DPR7Z	5537
90098-72021	DPR7EA-9	5129
90098-72023	CR7HSA	4549
90098-72024	BR7HS	4122
90098-72030	BPM7A	7321
90098-72036	BR7EIX	6664
90098-72037	DR7EIX	5686
90098-72042	DCP7E	2363
9		

À TITRE INDICATIF

TOYOTA	NGK	N° STOCK
90919-01051	BPR5ES	7422
90919-01055	BP-2E	5411
90919-01056	BP4EY	1028
90919-01059	BP5EY	7327
90919-01061	BP5EY	7327
90919-01063	BPR6EK-A	7726
90919-01064	BPR5EY	2828
90919-01065	BPR5EY	2828
90919-01073	B5ES	6410
90919-01083	BP6EY	7727
90919-01084	BPR6EY	6427
90919-01085	BP4EY-11	3928
90919-01087	BP5EK-A	6727
90919-01088	BPR6EK-A	7726
90919-01089	BPR6EK-A	7726
90919-01091	BPR5EY	2828
90919-01092	BPR6EK-A	7726
90919-01094	BP5EY-11	4028
90919-01095	BPR5EIX-11	2115
90919-01096	BPR5EIX-11	2115
90919-01097	BPR6EK-A	7726
90919-01098	BPR6EY	6427
90919-01099	BP4EY	1028
90919-01100	BP5EFS	3712
90919-01101	BP5EY	7327
90919-01102	BPR5EY	2828
90919-01103	BPR4EY	2128
90919-01104	BPR5EY-11	3028
90919-01108	BPR4EY-11	1143
90919-01109	BPR4EY-11	1143
90919-01113	BRE527Y-11	6029
90919-01114	BRE527Y-11	6029
90919-01115	BPR5EP-11	3971
90919-01116	BPR5EP-11	3971
90919-01117	BE529Y-11	5929
90919-01118	BE529Y-11	5929
90919-01119	BRE529Y	6229
90919-01120	BRE529Y	6229
90919-01121	BCPR5EIX-11	3306
90919-01122	BCPR5EIX-11	3306
90919-01123	BRE529Y-11	6429
90919-01125	BPR6EY-11	4228
90919-01126	BPR6EY-11	4228
90919-01127	BCPR6EP-11	3350
90919-01128	BCPR6EP-11	3350
90919-01129	BCPR5EY-11	4120
90919-01130	BCPR5EY-11	4120
90919-01131	BCPR6EY-11	3720
90919-01132	BCPR6EY-11	3720
90919-01133	BPR5EP-11	3971
90919-01134	BPR5EP-11	3971
90919-01135	BCPR6EIX-11	4919
90919-01136	BCPR6EIX-11	4919
90919-01138	BP6EY	7727
90919-01139	BP6EY-11	4128
90919-01143	BPR5EP-11	3971
90919-01144	BPR5EP-11	3971
90919-01145	BCPR6EP-N-8	5275
90919-01146	BCPR6EP-N-8	5275
90919-01147	BPR6EP-8	4542
90919-01148	BPR6EP-8	4542
90919-01149	BCPR6EY	1146
90919-01150	BCPR6EY	1146
90919-01151	BCPR5EP-8	2950
90919-01152	BCPR5EP-8	2950
90919-01153	BCPR5EY-11	4120
90919-01154	BCPR5EY	1266
90919-01155	BCRE527Y	2074
90919-01156	BCRE527Y	2074
90919-01157	BCPR6EIX-11	4919
90919-01158	BCPR5EIX-11	3306
90919-01159	BCPR5EY-11	4120

90919-01162	BCPR6EP-8	3933
90919-01165	BKR5EYA-11	2526
90919-01166	BKR6EYA-11	4073
90919-01167	BKR6EYA	2249
90919-01168	BKR5EP-11	3440
90919-01169	BKR5EP-11	3440
90919-01170	BCPR4EY-11	2440
90919-01172	BKR6EP-N-8	4885
90919-01173	BKR6EP-N-8	4885
90919-01176	BKR5EYA	2087
90919-01177	BKR5EYA	2087
90919-01178	BKR6EP-11	2978
90919-01179	BKR6EP-11	2978
90919-01180	BKR6EP-8	2215
90919-01181	BKR6EP-8	2215
90919-01182	BCPR6EIX-11	4919
90919-01185	BKR6EYA-11	4073
90919-01187	BKR6EP-13	2550
90919-01188	BKR6EP-13	2550
90919-01192	BKR5EKB-11	3967
90919-01193	BKR5EKB-11	3967
90919-01195	BKR6EKP-11	3452
90919-01196	BKR5EKP-11	4302
90919-01197	BKR5EKP-11	4302
90919-01198	BKR6EKB-11	3583
90919-01201	BKR5EKP-13	6874
90919-01202	BKR6EKB-11	3583
90919-01207	BKR6EIX-11P	2574
90919-01208	BKR6EPA-8	6485
90919-01213	BKR6EPA-8	6485
90919-01220	BKR6EP-11	2978
90919-01225	BKR6EIX-11P	2574
90919-01242	BKR5EYA-11	2526
90919-01244	BKR5EYA	2087
90919-01245	BKR5EYA	2087
90919-YZZAA	BCP5E	4975
90919-YZZAB	BCP6E	5860
90919-YZZAC	BKR6E-11	2756
90919-YZZAD	BKR5EYA	2087
90919-YZZAE	BKR5EYA-11	2526
90919-YZZAF	BKR6EYA	2249
90919-YZZAG	BKR6EYA-11	4073
90999-09006	BP5EY	7327
90999-09007	BP6EY	7727
99098-22695	BP7ES	2412

VALEO	NGK	N° STOCK
2/13	AB-8	7909
2/32	B8HS	5510
2/32H	B8ES	2411
2/33	B8HS	5510
2/33H	B7ES	1111
4N	B7HS	5110
5H	B7ES	1111
5N	BP6HS	4511
5NCYCLO	BP6HS	4511
6H	BP7ES	2412
6N	BP5HS	4111
7H	BP6ES	7811
8H	BP6ES	7811
9H	BP5ES	6511
17C	AB-7	3010
19C	AB-7	3010
19E	AB-7	3010
19L	AB-7	3010
20C	AB-6	2910
20E	AB-6	2910
20L	AB-6	2910
21C	AB-6	2910
21E	AB-6	2910
21L	AB-6	2910
22L	AB-2	3020
22LM	AB-2	3020
32LM	AB-2	3020

34C	B7S	3710
34CM	B7S	3710
34HS	B7ES	1111
34HSM	B7ES	1111
34S	B7HS	5110
35	B6HS	4510
35/1	BP6HS	4511
35/1B	BP6HS	4511
35/1D	BP6HS	4511
35/36D	B6HS	4510
35/36P	B6HS	4510
35/36R	B6HS	4510
35B	B6HS	4510
35C	B6S	3510
35CM	B6S	3510
35HA	BP6ES	7811
35HS	B6ES	7310
35M	B6HS	4510
35P	B6HS	4510
36	B5HS	4210
36B	B5HS	4210
36C	B-4	3210
36CM	B-4	3210
36D	B5HS	4210
36HS	B5ES	6410
36M	B5HS	4210
36P	B5HS	4210
37S	B5HS	4210
64H	BP7ES	2412
67HP	BR8EIX	5044
70H	BP6ES	7811
76H	BP5ES	6511
84H	BP5ES	6511
88N	B5HS	4210
90H	BP5ES	6511
11720	B8HS	5510
12086	B8HS	5510
41306	AB-8	7909
C7H	BP6EFS	3812
C64H	BP6EFS	3812
C68H	BP6EFS	3812
CR20F	B-4	3210
F64H	BCP7ES	5030
F68H3	BCP6ET	4563
F72H3	BCP6ET	4563
F82H	BCP5ES	7496
GT34	BP7HS	5111
GT34/2H	BP6ES	7811
GT34/5	BP6HS	4511
GT34/5D	BP6HS	4511
GT34/5H	BP6ES	7811
GT34/5HA	BP6ES	7811
GT34/5HD	BP6ES	7811
GT34D	BP7HS	5111
GT34H	BP7ES	2412
GT34HD	BP6ES	7811
GT35	BP5HS	4111
GT35D	BP5HS	4111
GT35H	BP5ES	6511
GT35HD	BP5ES	6511
H32RG	B9EG	3530
H33RG	B8EG	3430
H34F	B8ES	2411
HA32/2	B8ES	2411
HA32RS	B9EG	3530
HF34	B7ES	1111
HF34F	B8ES	2411
R64H	BPR7ES	2023
R70H	BPR6ES	7822
R76H	BPR6ES	7822
R84H	BPR5ES	7422
R88N	BP6HS	4511
RC64H	BPR5EFS	2223
RC72H	BPR6EFS	3623

RF64H	BCPR7ES	3330
RF72H	BCPR6ES	2330
RF74H11	BKR6E-11	2756
RF80H	BKR6E	6962
RF80H11	BKR5E-11	6953
RF82H	BKR6E	6962
RR31HS	B10EG	3630
RR32HS	B9EGV	5827
RR33HSS	B8EGV	5627
SCGT34/5H	BP6EFS	3812
SCGT35H	BP6EFS	3812
V36A	B5HS	4210
V6N SOLEX	B5HS	4210

YAMAHA	NGK	N° STOCK
90793-20001	BR7EIX	6664
90793-20002	BR8EIX	5044
90793-20003	BR9EIX	3981
90793-20004	BR10EIX	6801
90793-20005	BR6HIX	3419
90793-20006	BR7HIX	7067
90793-20007	BR8HIX	7001
90793-20008	BPR8EIX	6684
90793-20010	DR7EIX	5686
90793-20011	DR8EIX	6681
90793-20012	DR9EIX	4772
90793-20013	DPR8EIX-9	2202
90793-20014	DPR9EIX-9	5545
90793-20015	CR7HIX	7544
90793-20016	CR8HIX	7669
90793-20017	BR10HIX	6692
90793-20018	BR10EIX	6801
90793-20021	DR7EIX	5686
90793-20022	DR8EIX	6681
90793-20023	DR9EIX	4772
90793-20024	BPR5EIX	6597
90793-20025	BPR8EIX	6684
90793-20026	BPR9EIX	6853
90793-20028	B85EGV	7498
90793-20029	B95EGV	2145
90793-20030	B105EGV	2171
90793-20031	B11EGV	5831
90793-20032	B10EG	3630
90793-20035	BP-4H	3311
90793-20037	BP4HS-10	5011
90793-20038	BP5HS-10	7429
90793-20039	BP6HSA	1046
90793-20040	BP5ES-11	7311
90793-20045	BP6ES-11	1212
90793-20051	D8HA	7112
90793-20053	D10EA	2720
90793-20054	DP6EA-9	1068
90793-20057	BR6HS	3922
90793-20058	BR7HS-10	1098
90793-20060	BR6ES	4922
90793-20062	BPR8ES	3923
90793-20065	BPR5EY	2828
90793-20066	BPR5EY-11	3028
90793-20067	BPR6EY	6427
90793-20068	BPR6EY-11	4228
90793-20069	BPR7EY-11	1149
90793-20071	CR7HSA	4549
90793-20072	CR8HSA	2086
90793-20075	DR8HS	5123
90793-20076	DR7ES	3123
90793-20077	DR8ES	5423
90793-20080	DPR9EA-9	5329
90793-20081	CR7HIX	7544
90793-20082	CR8HIX	7669
90793-20083	DPR8EIX-9	2202
90793-20084	DPR9EIX-9	5545
90793-20085	BPR6HIX	4085
90793-20086	BPR7HIX	5944
90793-20090	BPM7A	7321

À TITRE INDICATIF

90793-20091	BPM4A	5928	90890-78064	C8HA	2168	94701-00190	BP5HA	7426	94701-00422	LMAR7A-9	4908
90793-20092	BPM4A-10	6228	90890-78065	D6HA	6512	94701-00193	BR9EIX	3981	94701-0042400	LMAR9E-J	6884
90793-20093	BPM6A-10	6026	90890-78066	D6EA	7512	94701-00194	BPR5HS	6222	94701-0043100	CPR9EA-9	2308
90793-20094	BPMR4A	6028	90890-78068	DPR9EIX-9	5545	94701-00195	BR8HS	4322	94701-00434	LMAR8G	95627
90793-20095	BPMR4A-10	6328	90890-78070	B9HS-10	3626	94701-00198	BPR6HS	7022	94701-0084000	CR7E	4578
90793-20096	BPMR6A-10	1029	90890-78071	BP8HS	2630	94701-00203	DR8ES-L	2923	94701-0084200	BR8HS	4322
90793-20098	BPMR7A	4626	90890-78072	BP9ES	7526	94701-00204	BR8ES	5422	94701-0086900	CR6HSA	2983
90793-20099	BR9HIX	5687	90890-78073	BP4HA	3511	94701-00208	DR7ES	3123	94701-0087100	CPR9EA-9	2308
90793-20100	BR10HIX	6692	90890-78074	BM6A	5921	94701-0021500	C7HSA	4629	94701-0087800	CR7HSA	4549
90793-20101	BPR6HIX	4085	90890-78075	BM7A	6521	94701-00217	B7HS-10	2129	94701-00X0000	CR8E	1275
90793-20102	BPR7HIX	5944	90890-78076	BPM6A	7021	94701-00218	BPR7ES	2023	94701-00X0900	CR7E	4578
90793-20103	BPR8HIX	6742	90890-78077	BR9HS	4522	94701-00219	BPR8ES	3923	94701-00X1100	DPR8EA-9	4929
90793-20106	BPR5EIX	6597	90890-78078	BPR7EIX	4055	94701-00227	BPR7HS	6422	94701-00X1200	BR8HS	4322
90793-20107	BPR6EIX	6637	90890-78079	BPR6EIX	6637	94701-00232	BP6HS-10	6326	94702-0003900	B6HS	4510
90793-20108	BPR5EIX-11	2115	90890-78082	B10EGV	5927	94701-00234	BPR6ES	7822	94702-0004000	B7HS	5110
90793-20109	BPR6EIX-11	3903	94700-0010000	BPR7HS	6422	94701-00237	BP8HS-10	3823	94702-0004100	B8HS	5510
90793-20110	BPR7EIX	4055	94700-0011000	BR7HS	4122	94701-00241	DPR8EA-9	4929	94702-00044	B7ES	1111
90793-20112	BR8EIX	5044	94700-0019500	BR8HS	4322	94701-00248	BR6HS	3922	94702-0004400	B7ES	1111
90793-20113	BP8HS-10	3823	94700-0020400	BPR7HS	6422	94701-00250	CR7HSA	4549	94702-00045	B8ES	2411
90793-20115	BR10EIX	6801	94700-0022700	BPR7HS	6422	94701-00251	BR9HS	4522	94702-0004500	B8ES	2411
90793-20116	BPR5EIX	6597	94700-0026200	DPR7EA-9	5129	94701-00254	C7HSA	4629	94702-00046	B9ES	2611
90793-20117	BPR6EIX	6637	94700-0035200	CR7E	4578	94701-00256	C6HSA	3228	94702-00149	B7HS	5110
90793-20118	BR9EIX	3981	94700-0035300	CR7E	4578	94701-00258	BPR4HS	7823	94702-0016000	B8HS-10	5126
90793-20119	DPR8EIX-9	2202	94700-0036600	CR7HSA	4549	94701-00262	DPR7EA-9	5129	94702-00188	BR9ES	5722
90793-20120	DPR8EIX-9	2202	94700-0037200	CR6HSA	2983	94701-00263	DP7EA-9	5629	94702-00193	BR9EIX	3981
90793-20121	BR6FS	4323	94700-00434	LMAR8G	95627	94701-00264	B7HS-10	7829	94702-00195	BR8HS	4322
90793-20122	CR8EIX	4218	94700-0081200	BPR7HS	6422	94701-0026500	CR7HSA	4549	94702-00204	BR8ES	5422
90793-20123	CR9EIX	3521	94700-0082200	DR8EA	7162	94701-00266	D9EA	2420	94702-00211	BPMR6A	6726
90793-20124	CR8EIX	4218	94700-0083400	CR7HSA	4549	94701-00267	BP8ES	2912	94702-0021700	B7HS-10	2129
90793-20125	CR9EIX	3521	94700-0083600	BPR7HS	6422	94701-00268	BP8HS	2630	94702-00234	BPR6ES	7822
90793-20127	BPR7ES-11	7226	94700-0084000	CR7E	4578	94701-00273	B6HS-10	1052	94702-00247	BR8HS-10	1134
90793-20128	BR4ES	1097	94700-0084200	BR8HS	4322	94701-00274	BR6HS-10	1090	94702-00248	BR6HS	3922
90793-20129	BPR7HS-10	1092	94700-0085200	DR7EA	7839	94701-00275	DP8EA-9	5829	94702-00249	BR5HS	3722
90793-20130	BR4HS	3322	94700-0086900	CR6HSA	2983	94701-0027600	B9EG	3530	94702-00271	BR7HS-10	1098
90793-20131	BR5HS	3722	94700-0087100	CPR9EA-9	2308	94701-00280	BPR8HS	3725	94702-00272	BR7HS	4122
90793-20132	CR6HSA	2983	94700-0087600	CR7E	4578	94701-00282	CR6HS	7023	94702-00274	BR6HS-10	1090
90793-20133	CR7HSA	4549	94700-0088000	CR6HSA	2983	94701-00284	BPR6EIX	6637	94702-00309	BR9HS-10	4551
90793-20134	BR8EG	3130	94700-0088100	CR7E	4578	94701-00285	BPR6EIX	6637	94702-00317	B9HS-10	3626
90793-20135	BR9EG	3230	94700-0089300	CPR9EA-9	2308	94701-00287	DR8ES	5423	94702-00323	B8EG	3430
90793-20136	BR10EG	3830	94700-00X0000	CR8E	1275	94701-00292	BPR6HS-10	2633	94702-00324	BR9EG	3230
90793-20138	BPR6EIX	6637	94700-00X1100	DPR8EA-9	4929	94701-00300	CR5HS	2874	94702-00325	B9EG	3530
90793-20139	BR8ECM	3035	94700-00X1200	BR8HS	4322	94701-00309	BR9HS-10	4551	94702-00326	BR8EG	3130
90793-20140	BR10ECM	4234	94701-00039	B6HS	4510	94701-00311	BR5ES	4722	94702-00331	BPR4ES	7222
90793-20150	CR8EIX	4218	94701-00040	B7HS	5110	94701-00315	C9E	7499	94702-00343	BR4ES	1097
90793-20151	CR9EIX	3521	94701-00041	B8HS	5510	94701-00318	CR9E	6263	94702-00348	BPR2ES	2264
90793-20152	DR8EIX	6681	94701-00042	B9HS	5810	94701-0031900	CR9E	6263	94702-00349	BR7ES	5122
90793-20153	DR9EIX	4772	94701-00043	B6ES	7310	94701-0032400	BR9EG	3230	94702-00357	BR9ECM	3252
90793-20154	DPR8EIX-9	2202	94701-00044	B7ES	1111	94701-00328	BPR5ES	7422	94702-00367	B10EG	3630
90793-20155	DPR9EIX-9	5545	94701-00045	B8ES	2411	94701-0032900	CR8E	1275	94702-0036800	BR10EG	3830
90793-20156	BPR6HIX	4085	94701-00046	B9ES	2611	94701-00330	CR8E	1275	94702-00372	CR6HSB	6500
90793-20157	BPR7HIX	5944	94701-00048	B8HCS	2621	94701-0033100	BPR4ES	7222	94702-00374	R7282-105	4985
90793-20158	BR6HIX	3419	94701-00050	BP7HS	5111	94701-00332	R5184-105	3334	94702-00383	BR9ECS	3570
90793-20159	BR7HIX	7067	94701-00061	BR8EIX	5044	94701-00333	DR8EA	7162	94702-00384	BR10ECS	5880
90793-20160	BR8EIX	5044	94701-00063	BR9EIX	3981	94701-0033600	BPR5HS	6222	94702-00391	LFR5A-11	6376
90793-20161	BR9EIX	3981	94701-00069	B5HS	4210	94701-00340	DR9EA	3437	94702-0039600	BR8ES-11	7986
90793-20162	CR8EHIX-9	3797	94701-0007200	D9EA	2420	94701-00345	DR7EA	7839	94702-0039900	BKR7EUK	5881
90793-20163	CR9EHIX-9	6216	94701-0007500	BR9EIX	3981	94701-00353	CR7E	4578	94702-00400	LFR6A-11	3672
90793-20164	BR8HIX	7001	94701-00078	B5ES	6410	94701-00354	CR4HSA	2430	94702-0040100	BKR6EUK	6993
90793-20165	BR10EIX	6801	94701-0010000	BR8HS	4322	94701-00358	C7E	5096	94702-0040300	CR9EKB	2305
90793-20166	BPR8HIX	6742	94701-00108	BP6HS	4511	94701-00361	DPR9EA-9	5329	94702-00404	BKR7EUK	5881
90793-20167	BPR5EIX	6597	94701-00110	BR7HS	4122	94701-00365	BR6FS	4323	94702-00405	BKR6EUK	6993
90793-20168	BPR6EIX	6637	94701-00111	BR6ES	4922	94701-00372	CR6HSA	2983	94702-00409	CR9EB	6955
90793-20169	CR5HIX	7120	94701-00112	BR7ES	5122	94701-00375	DPR6EA-9	5531	94702-00418	DPR6EB-9	3108
90793-20170	CR6HIX	7274	94701-00113	BR8EIX	5044	94701-00386	CR10EK	2360	94702-00419	CR4HSB	4695
90793-20171	CR7HIX	7544	94701-00116	BP6ES	7811	94701-00395	CR9EK	4548	94702-0042700	LFR6A	6668
90793-20172	CR7EIX	7385	94701-00117	BP7ES	2412	94701-00402	CR10EK	2360	94702-0042800	CPR8EB-9	6607
90793-20173	DPR7EIX-9	7803	94701-00118	BP8ES	2912	94701-0040200	CR10EK	2360	94702-0042900	LKR7E	1643
90793-20174	CR8HIX	7669	94701-00148	BR8HIX	7001	94701-00403	CR9EK	4548	94702-0080500	BR4ES	1097
90793-20175	BPR7EIX	4055	94701-00157	D8EA	2120	94701-00406	DPR5EA-9	2887	94702-0082100	BPR6HS	7022
9079E-NG001	BR8EIX	5044	94701-00159	BP4HS	3611	94701-0040700	CR9EIA-9	6289	94702-00X0000	BR7HS	4122
9079E-NG002	BR9EIX	3981	94701-00160	B8HS-10	5126	94701-00408	CR9EIA-9 </				

À TITRE INDICATIF

YAMAHA	NGK	N° STOCK
94703-00039	B6HS	4510
94703-00040	B7HS	5110
94703-00041	B8HS	5510
94703-00042	B9HS	5810
94703-00043	B6ES	7310
94703-00044	B7ES	1111
94703-00045	B8ES	2411
94703-00046	B9ES	2611
94703-00050	BP7HS	5111
94703-00059	BR7HIX	7067
94703-00060	BR9HIX	5687
94703-00062	BR6HIX	3419
94703-00065	BR7EIX	6664
94703-00069	B5HS	4210
94703-00074	BR8EIX	5044
94703-00075	BR9EIX	3981
94703-00078	B5ES	6410
94703-00108	BP6HS	4511
94703-00109	BP-2E	5411
94703-00110	BR7HS	4122
94703-00112	BR7ES	5122
94703-00113	BR8EIX	5044
94703-00114	BR9EIX	3981
94703-00116	BP6ES	7811
94703-00117	BP7ES	2412
94703-00118	BP8ES	2912
94703-00133	BP5ES	6511
94703-00143	BR8HIX	7001
94703-00148	BR8HIX	7001
94703-00157	D8EA	2120
94703-00159	BP4HS	3611
94703-00160	B8HS-10	5126
94703-00168	BP5HS	4111
94703-00188	BR9ES	5722
94703-00189	D7EA	7912

94703-00190	BP5HA	7426
94703-00191	BP4ES	6928
94703-00194	BPR5HS	6222
94703-00198	BPR6HS	7022
94703-00203	DR8ES-L	2923
94703-00204	BR8ES	5422
94703-00207	B4ES	4129
94703-00213	C6HA	4712
94703-00217	B7HS-10	2129
94703-00218	BPR7ES	2023
94703-00221	BP2HS	7926
94703-00227	BPR7HS	6422
94703-00232	BP6HS-10	6326
94703-00234	BPR6ES	7822
94703-00241	DPR8EA-9	4929
94703-00254	C7HSA	4629
94703-00256	C6HSA	3228
94703-00258	BPR4HS	7823
94703-00262	DPR7EA-9	5129
94703-00263	DP7EA-9	5629
94703-00264	BP7HS-10	7829
94703-00266	D9EA	2420
94703-00267	BP8ES	2912
94703-00273	B6HS-10	1052
94703-00275	DP8EA-9	5829
94703-00277	B9EGV	5827
94703-00279	B8EGV	5627
94703-00282	CR6HS	7023
94703-00310	C2H	2211
94703-00311	BR5ES	4722
94703-00314	C8E	7471
94703-00315	C9E	7499
94703-00318	CR9E	6263
94703-0031900	CR9E	6263
94703-00320	BP7ES-11	2712
94703-00323	B8EG	3430
94703-00325	B9EG	3530

94703-00328	BPR5ES	7422
94703-00330	CR8E	1275
94703-00332	R5184-105	3334
94703-00333	DR8EA	7162
94703-00334	B-2H	3411
94703-00340	DR9EA	3437
94703-00345	DR7EA	7839
94703-00353	CR7E	4578
94703-0036600	CR7HSA	4549
94703-00370	DR2HS	3487
94703-00381	CR6E	6965
94703-0040300	CR9EK	4548
94703-00406	DPR5EA-9	2887
94703-0040800	CR9EIA-9	6289
94703-00410	CR9E	6263
94703-00411	CR8E	1275
94703-00420	CPR7EA-9	3901
94703-0042400	LMAR9E-J	6884
94703-00434	LMAR8G	95627
94709-0018800	BR9ES	5722
94709-00193	BR9EIX	3981
94709-00195	BR8HS	4322
94709-00211	BPMR6A	6726
94709-00247	BR8HS-10	1134
94709-00274	BR6HS-10	1090
94709-00309	BR9HS-10	4551
94709-00324	BR9EG	3230
94709-00326	BR8EG	3130
94709-00337	BR10EIX	6801
94709-00342	BPR4EY	2128
94709-00348	BPR2ES	2264
94709-00357	BR9ECM	3252
94709-00372	CR6HSB	6500
94709-00373	R7376-10	4457
94709-0037400	R7282-105	4985
94709-00383	BR9ECS	3570
94709-00384	BR10ECS	5880

94709-00391	LFR5A-11	6376
94709-00400	LFR6A-11	3672
94709-00404	BKR7EKU	5881
94709-00405	BKR6EKU	6993
94709-00409	CR9EB	6955
94709-00418	DPR6EB-9	3108
94709-00419	CR4HSB	4695
94793-20037	BP4HS-10	5011
94793-20038	BP5HS-10	7429

YANMAR	NGK	N° STOCK
119717-77801	Y1021J	97627
119718-77801	Y1022	92276
124970-77800	Y-116V	2131
129008-77800	Y-546J	95275
129155-77800	Y-702R	1065
129155-77801	Y-702U	2966
129331-77800	Y-110V	5243
129795-77800	Y-103V	2031
160110-78011	B6HS	4510
160232-78010	B-4H	4110
160520-78010	BPM4A	5928
160560-78010	BPMR4A	6028
160610-78010	BP4HS	3611
160690-78010	BP6ES	7811
160690-78020	BP5ES	6511
160693-78010	BPR6ES	7822
160769-78010	BR4HS	3322
160793-78010	BPR5ES	7422
160798-78010	BPR2ES	2264
160810-78010	BPR4HS	7823
160998-78010	BPR6EY	6427
1C1015-66250	Y-715R	5376

ZENOA	NGK	N° STOCK
3699-91867	CMR7H	3066



VÉHICULES SANS PERMIS

Bougies d'allumage et de préchauffage

PRÉCHAUFFAGE



TYPE

CYL.

CODE MOTEUR



N° DE STOCK

AIXAM

Kubota	Mono	276	OC 60	94-01	Y-709R	3238
Kubota	Bi	400	Z400	-93	Y-103V	2031
Kubota	Bi	400	Z400	93-	Y-702R	1065
Kubota	Bi	400	Z402	10-	YE01	2649
Kubota	Bi	482	Z482B	93-01	YE01	2649

BELLIER

Lombardini	Bi	505	Focs	93-	Y-924J	7906
Yanmar	Bi	523	2 / 3TNE68	94-	Y-103V	2031

CHATENET

Lombardini	Bi	505	FOCS	93-	Y-924J	7906
------------	----	-----	------	-----	--------	------

ERAD

Lombardini	Bi	505	FOCS	94-97	Y-924J	7906
Kubota	Bi	400	Z400	93-95	Y-702R	1065
Kubota	Tri	600	D600B	93-97	YE01	2649

GRECAV

Lombardini	Bi	505	FOCS	93-	Y-924J	7906
------------	----	-----	------	-----	--------	------

JDM

Lombardini	Bi	505	FOCS	93-	Y-924J	7906
Yanmar	Bi	523	2 / 3TNE68	94-	Y-103V	2031

LIGIER

Lombardini	Bi	505	FOCS	93-	Y-924J	7906
------------	----	-----	------	-----	--------	------

TEILHOL-APP-CENTURY

Lombardini	Bi	505	FOCS	93-	Y-924J	7906
------------	----	-----	------	-----	--------	------

MICROCAR

Lombardini	Bi	505	FOCS	93-	Y-924J	7906
------------	----	-----	------	-----	--------	------

SAVEL

Lombardini	Bi	505	FOCS	93-	Y-924J	7906
------------	----	-----	------	-----	--------	------

ALLUMAGE



TYPE

CYL.

CODE MOTEUR



N° DE STOCK

AIXAM

Lombardini	Mono	340	LGA340	99-02	BKR5E	7938
------------	------	-----	--------	-------	-------	------

CYCLOS - MOTOS
NGK ÉQUIPE D'ORIGINE :

Aprilia • Betamotor • BMW •
Cagiva • Derbi • Ducati • Gas
Gas • Her Chee • Honda •
Husqvarna • JI-EEE • Kawasaki •
KTM • Kwang Yang • LML • MBK
Minarelli • Modenas • Motive
Power • Peugeot Motocycles •
Piaggio • Rotax • Sanyang •
Sundown • Suzuki • Triumph •
Victory • Yamaha

MOTOCULTURE
NGK ÉQUIPE D'ORIGINE :

Alko • Brill • Dolmar • Echo •
Efco • Hercules • Honda •
Husqvarna • Iseki • Ishikawajima •
John Deere • Jonsered •
Kawasaki • Kubota • Little
Wonder • Makita • Mitsubishi
• Mountfield • Nissan • Robin
• Sabre • Shindaiwa • Solo •
Stihl • Suzuki • Tanaka • Toro •
Yamaha • Yanmar

MARINE
NGK ÉQUIPE D'ORIGINE :

Arctic Cat (Tigershaft) • Bombardier
(Sea-Doo) • Emerald Bay •
Evinrude • Honda • Johnson •
Kawasaki • Lehr • Mariner •
Mercruiser • Mercury • Nissan •
Polaris • Spirit • Suzuki • Tanaka •
Tohatsu • Yamaha

CONTACT COMMERCIAL

ngk-commercial@ngkntk.fr

CONTACTS TECHNIQUES

Tél. : 01 55 60 27 05 / Fax : 01 41 10 80 66
ngk-service-technique@ngkntk.fr

www.ngkntk.fr | www.ngk-elearning.com

NGK NTK
SPARK PLUGS TECHNICAL CERAMICS
NGK SPARK PLUGS (FRANCE) S.A.S.

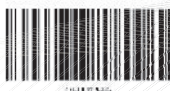

QEU002685
P333

CAT.2W/MTC/MAR 17-18

1 Stück
Pièce



NGK Spark Plugs France
9 avenue Réaumur – Immeuble Astrale
CS 50009 — 92354 LE PLESSIS ROBINSON
Tél : 01 55 60 27 00